

Ulrich Schaaf*, Maciej Prarat, Tomasz Ważny*****

*The mediaeval roof structure over the nave
of the cathedral in Kamień Pomorski
in the light of architectural and dendrochronological research*

Introduction

The subject of this article is the roof structure over the nave of the cathedral of St. John the Baptist in Kamień Pomorski.

Numerous scientific and popular studies have been written on the history of the construction of the cathedral in Kamień, but none of them discusses roof structures, either in the context of their construction history, or in the context of the applied carpentry art [1]–[6]. Only the building survey drawing included in Ohle's works shows the roof structures in the following sections: longitudinal through the transept facing east, longitudinal through the transept facing west, transverse through the nave, and longitudinal through the entire cathedral facing north [5, Figs. VII, X, XI, XVI]. The roof structures of the cathedral in Kamień have not been included in the literature relating directly to the history of mediaeval and modern roof structures¹.

This research gap and the need to repair the roof structure over the nave body of the cathedral became the reason for the carrying out of architectural history investigation in order to learn thoroughly its history of construction and the construction techniques used in various periods. Owing to the advancement of repairs that had been going on for several years and the related replacement of many

structural elements, the architectural research focused primarily on the last ten eastern trusses not yet covered by conservation works (19–28).

The substantive extent of the research included: firstly, the analysis of the carpentry technique used to build and repair the roof structure (the following were taken into account: the arrangement of structural elements, timber framing sides, carpentry joints, a system of carpentry assembly marks, and building material and its processing), secondly – chronological stratification on the basis of material analysis of the substance and literature, as well as dendrochronological research, and thirdly – an attempt to determine the significance of the mediaeval roof structure. The test results are presented below in the same order.

Analysis

The nave of the cathedral is crowned with a cross-braced collar beam roof structure. It consists of 28 trusses with a span of approximately 13 m, a height of approximately 10 m, and an inclination angle of approximately 58°. The axial distance between the trusses varies from 0.93 m to 1.23 m. The trusses with tie beams (two each time) are located above the inter-span buttresses of the cross-ribbed vault. The remaining trusses between them (from six to seven) are devoid of tie beams, i.e. they are free trusses because the vault apexes reach above the level of the tie beams.

Architectural studies have shown that three additional construction units were added to the cross-braced collar beam roof structure: first, the entablature slightly above the rise of the vault, second, the inclined standing queen post structure, and third, the king post structure. The entablature is carried by short studs based on the original internal wall plates. Two frames with inclined roof strengthening structures rest on this entablature and support the lower

* ORCID: 0000-0003-3055-1009. Faculty of Fine Arts, Nicolaus Copernicus University in Toruń, Poland, e-mail: u.schaaf@umk.pl

** ORCID: 0000-0001-7076-2009. Faculty of Fine Arts, Nicolaus Copernicus University in Toruń, Poland.

*** ORCID: 0000-0001-6641-0131. Faculty of Fine Arts, Nicolaus Copernicus University in Toruń, Poland.

¹ The roof structures of the Kamień Pomorski Cathedral are not mentioned in works dealing with the history of roof structures in Poland, e.g. in studies by Raczyński [7], Ganowicz [8], or in works relating to a wider area, e.g. in the publications by Ostendorf [9] or Binding [10].

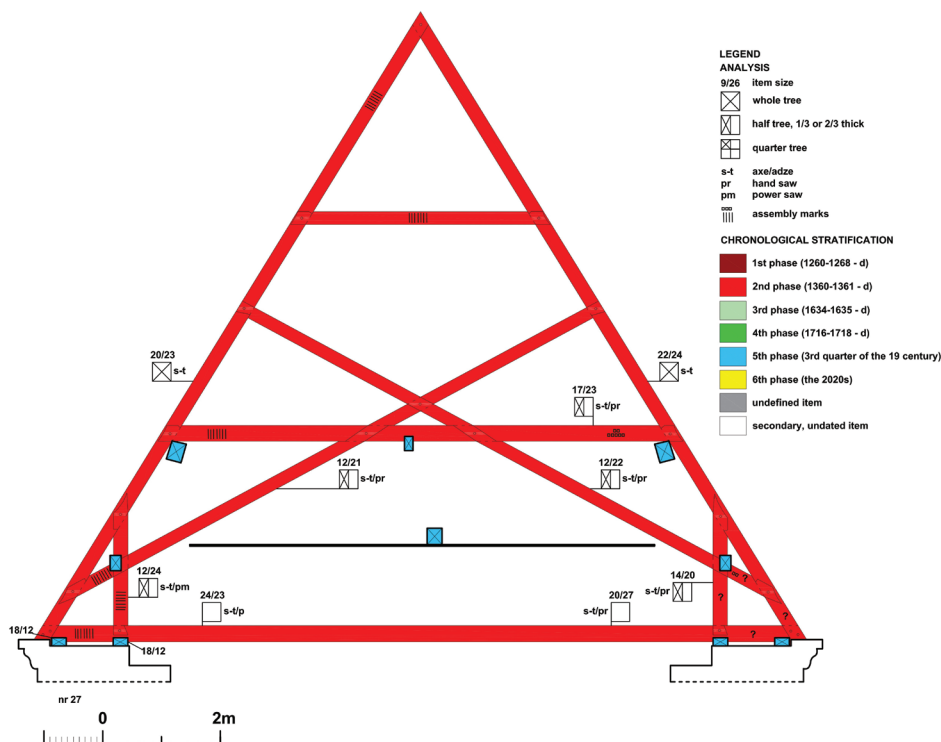

Fig. 1. Kamień Pomorski, cathedral, roof structure above the aisle, principal rafter truss, No. 27, analysis and stratification (elaborated by U. Schaaf, M. Prarat)

Il. 1. Kamień Pomorski, katedra, więźba dachowa nad nawą, więźar pełny, nr 27, analiza i rozwarstwienie (oprac. U. Schaaf, M. Prarat)

collar at their connection to the rafters. Together with posts and passing braces, some of these beams constitute the trusses of the king post structure. The entablature is suspended from its central longitudinal frame of the king post structure. Neither the position of the secondary entablature nor of the king- and queen-posts coincides with the location of the primary roof trusses of the cross-braced collar beam roof structure, as they are always located next to it.

The results of the detailed analysis of the eastern trusses (19–28) were discussed separately for the cross-braced collar beam roof structure and separately for the secondary entablature with frames the inclined standing queen post structure and the king post structure.

Cross-braced collar beam roof structure

1. Primary characteristics of cross-braced collar beams
 - Structural layout

In the principal rafter trusses (19, 20, 27 – Fig. 1), the tie beams rest at both ends, each time on two wall plates lying on mural crown of the outer walls of the nave. These tie beams are connected with rafters with a length of about 12.50 m, which are supported by two rows of collar beams. The almost vertical down braces connect the tie beams with the rafters roughly in the axis of the inner wall plates and stiffen the trusses in the lower zones. Long intersecting passing braces form additional stiffening and at the same time support the rafters. They connect to the rafters just above the tie beams, intersect with the passing braces, the lower collar beam, and with each other, and end at the opposite rafters approximately halfway between the lower and upper collar beams. Paired common rafters (Fig. 2) differ from the principal rafter trusses only

in that instead of the continuous tie beam there are two sole pieces.

The layouts of the structural elements are repeatable both within principal rafter trusses and paired common rafters. However, some differences have been observed in the angle of inclination of the intersecting passing braces and at the level at which they connect with the rafters. This fact suggests that the carpenters did not use the 1:1 scale pattern when connecting the passing braces with the rafters on the carpentry platform.

The longitudinal stiffening of the roof structure was provided by oblique wind braces attached to the rafters at the bottom.

- Truss framing side

Architectural research has shown that the examined trusses (19–28) were set/mounted in such a way that the side on which the trusses were framed is now the eastern side². On this side, in each truss, the structural elements are in one plane, and the differences in cross-section are noticeable only on the rear side. The lap joints are also visible from the framing side; from this side wooden pegs were driven into the joints and the elements were provided with carpentry assembly marks (Fig. 3a).

- Carpentry joints

Three types of carpentry joints were used to connect the individual elements of the roof structure to each other: coggled joints, lap joints in various variants, and bridle joints.

² Also in the case of trusses 8–18 not included in the survey the eastern side is the timber framing side, while in the case of trusses 1–7 it is the western side.

Fig. 2. Kamień Pomorski, cathedral, roof structure above the nave, paired common rafter, no. 26, analysis and stratification (elaborated by U. Schaaf, M. Prarat)

II. 2. Kamień Pomorski, katedra, więźba dachowa nad nawą, wiązar niepehny, nr 26, analiza i rozwarstwienie (oprac. U. Schaaf, M. Prarat)

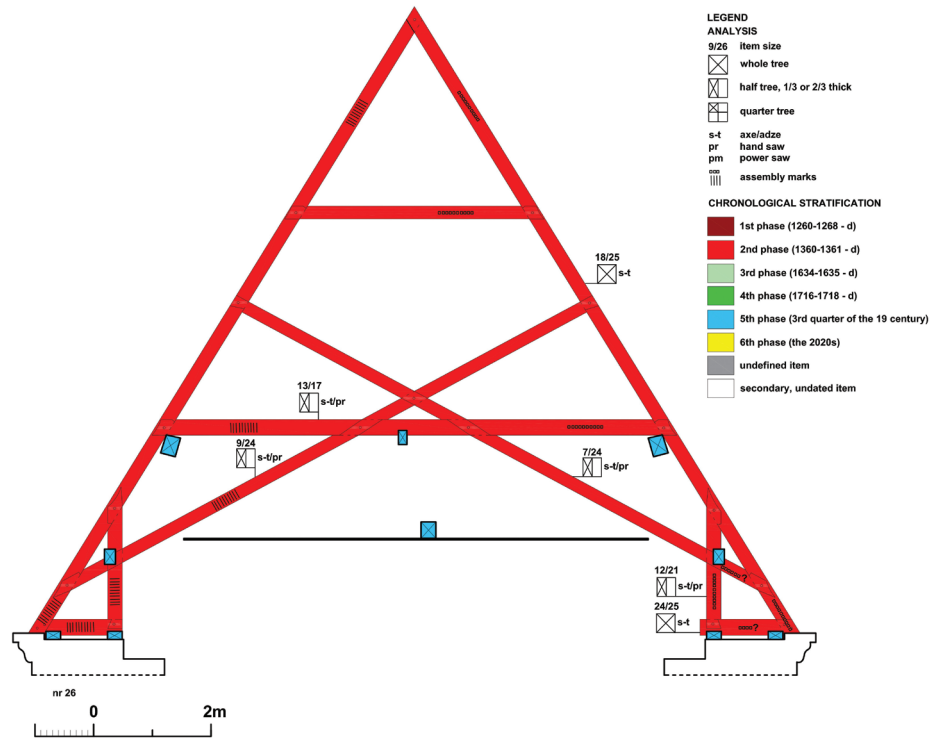

The tie beams and sole pieces are connected with the wall plates by a single coggled joint.

The rafters are connected with the tie beams and sole pieces only by a straight lap joint secured with two wooden pegs, while the tie beams and sole pieces have no protrusions. A scarf joint bridled was used to connect the rafters in the ridge.

Both the lower and the upper collars connect to the rafters by a notched pegged lap joint. It is a stopped lap joint, but its front side ends in a slightly arched cut in front of the rafter's edge. This shape does not fulfil a structural function, but a decorative one, showing the skills of the carpenter.

Down braces were connected at the lower end to the tie beams and sole pieces by single or double dovetail lap joint. The joint itself is secured with a wooden peg, and the sole pieces have short protrusions. At the upper end, the down braces reach the rafters with which they are connected with a notched pegged lap joint. As with collars, the lap joint is stopped. Moreover, the upper edge of the lap joint is slightly bevelled with respect to the angle of inclination of the down brace.

The intersecting long down braces are connected at their lower end with the rafters in the same way as the down braces are, i.e. with the notched stopped lap joint. The front side of the lap joint of the overlay is either curved or straight-ended. Passing braces intersect with down braces using straight pegged lap joints, with the lower collar using a cross lap (which additionally strengthened the transverse stiffening). The long intersecting passing braces and the lower collar intersect also with each other again using a straight lap joint or a notched joint. At the upper end, the passing braces are connected with the rafters using stopped lap joints of various shapes. There are, inter alia, the following forms of lap joint: dovetail, half dovetail, half dovetail with a notch.

The auxiliary lines during the creation of carpentry joints on the carpentry platform were made with a stylus, with traces preserved in places.

- System of carpentry assembly marks

All the examined trusses were marked in one direction, from the west to the east. Marks making it possible to distinguish elements on both sides of the axis of symmetry were also consistently used. Nevertheless, the marking system is varied.

In the first of the tested trusses from the west, in truss 19, the elements on the southern side are marked with a "V", and on the northern side with a "V" with a by-mark placed in the middle of the "V".

In the following trusses, from 20 to 27, the elements on the southern side were marked with line marks made with an axe or a hand adze (Fig. 3a), and on the northern side, with rectangular marks made with a chisel (Fig. 3b). Theoretically, the marks could grow from three to ten. However, during the assembly, there was probably confusion of the trusses, because the actual numbering in the trusses 20–27 is as follows, from the west to the east: 3, 4, 5, 6, 8, 9, 10, 7. However, this mistake did not create any problems, because all the common rafters, unlike principle rafters, have the same arrangement³.

In truss no. 28, the carpentry marks were not recognized, because it adjoins the brick gable between the nave and the aisle crossing with its timber framing side.

³ Also in the trusses not included in the analysis, simple numerical marks were used, distinguishing their left side from the right side. They have different shapes and are not always arranged in a logical numerical sequence.



Fig. 3. Kamień Pomorski, cathedral, roof structure above the nave: a) assembly mark in the form of straight lines made with a hand axe, b) assembly mark in the form of rectangular cuts made with a chisel, building material processed from the side of timber framing with a hand saw (photo by U. Schaaf, M. Prarat)

Il. 3. Kamień Pomorski, katedra, więźba dachowa nad nawą: a) znak montażowy w postaci prostych kresek wykonanych toporem ręcznym, b) znak montażowy w postaci prostokątnych nacięć wykonanych dłutem, budulec obrobiony od strony odwiązki piłą ręczną (fot. U. Schaaf, M. Prarat)



Fig. 4. Kamień Pomorski, cathedral, roof structure above the nave: a) initial processing of wooden building material made with an axe, b) smoothing of pre-processed wooden building material made with an adze (photo by U. Schaaf, M. Prarat)

Il. 4. Kamień Pomorski, katedra, więźba dachowa nad nawą: a) wstępna obróbka budulca drewnianego wykonana siekierą, b) wygładzanie wstępnie obrobionego budulca drewnianego wykonane toporem (fot. U. Schaaf, M. Prarat)

• Building material and its processing

The preliminary dendrochronological research shows that two types of wood were used for the construction of the truss: pine and oak. Pinewood predominates, while oak was used, among other things, in the case of both rafters in the extreme eastern truss adjacent to the brick gable between the nave and the aisle crossing (truss 28), and in the case of some passing braces [11].

An axe was used for the pre-treatment of the building material, with some traces in the form of “V” shaped cross-sections transverse to the direction of the fibres (Fig. 4a). Then the building material was smoothed with a carpenter’s adze, which left on the surface typical long and slightly rounded cuts running almost parallel to the fibres (Fig. 4b). Some of the elements processed in this way, called whole trees, were divided into smaller ones by dividing them with a hand saw. This process is evidenced by slightly oblique notches running unevenly across the

wooden elements (cf. Fig. 3a). In this way, half-trees or trees with a cross-section of 1/3 or 2/3 of the thickness were obtained. In some cases, hand saw processing from two parallel sides and a cross-sectional ratio close to the ratio of 1:3 prove that 1/3 of the tree was used⁴. In many cases, however, it was impossible to distinguish accurately between half-trees, 1/3, or 2/3 of the tree. This applies to elements that show traces of a hand saw on only one side. Only in one case was the use of a quarter-tree found, which was processed with an axe and an adze on both sides, and a handsaw on both sides.

The tie beams and short tie beams were made exclusively of the whole tree. Their cross-section ranges from 20–25 × 18–30 cm. Whole trees and half-trees or 1/3 or

⁴ This is the case, among other things, with the down brace and the passing brace on the northern side of truss no. 19.

2/3 trees with a cross-section of 17–24 × 22–26 cm were used for the rafters. Also, down braces were made from both the whole tree and the half-tree, or 1/3 or 2/3 of the tree; their cross-section is 9–22 × 20–28 cm. The intersecting passing braces are only half-trees or 1/3 or 2/3 of trees with a cross-section of 7–13 × 22–24 cm.

• Building material transport

In some structural elements, two round holes, about 3 cm in diameter, with remnants of withes and wedges have been observed (Fig. 5). This proves that at least some of the structural elements were transported by rafts from the felling site in or around the forest to the site near the construction site. These rafts must have been built each time from several branch-stripped logs, connected to each other by a pole placed over them in a transverse direction, and attached to each log with a withe and secured with two wedges. The greater number of holes with remnants of withes and wedges suggest that the raft was repaired or rebuilt during transport. These traces also prove that the logs were floated first, and then the building material was made of them.

Booms with ropes were used for the vertical transport of structural elements from the ground level to the level of the roof structure. Special cuts were made at the corners of the given element to prevent slippage of the rope with which it was wound up and then pulled upwards. Such cuts were found on various elements of the roof structure.

2. Characteristics of changes introduced to cross-braced collar beams

The analysis of the construction has shown that the original structural elements have been preserved in the vast majority of the thoroughly examined trusses. Only in



Fig. 5. Kamień Pomorski, cathedral, roof truss over the nave, building material with traces of float in the form of round holes with the remains of wedges and withes (elaborated by U. Schaaf, M. Prarat)

Il. 5. Kamień Pomorski, katedra, więźba dachowa nad nawą, budulec ze śladami splanu w postaci okrągłych otworów z resztkami klinów i śryków (oprac. U. Schaaf, M. Prarat)

trusses 19–20 and 22, has the replacement of some wooden elements in full or their fragments, or the addition of wooden elements been found.

In truss 22 (Fig. 6) on the southern side, the down brace zone was re-strengthened by introducing an additional sole piece placed on the primary sole piece and an additional down brace adjacent to the primary brace. These elements are connected with each other and with the original structure using pegged lap joints of various shapes. These are traditionally processed with an axe, adze, and handsaw in the case of a brace, but have no carpentry assembly marks.

Fig. 6. Kamień Pomorski, cathedral, roof structure above the nave, paired common rafter, no. 22, analysis and stratification (elaborated by U. Schaaf, M. Prarat)

Il. 6. Kamień Pomorski, katedra, więźba dachowa nad nawą, wiązar niepełny, nr 22, analiza i rozwarstwienie (oprac. U. Schaaf, M. Prarat)

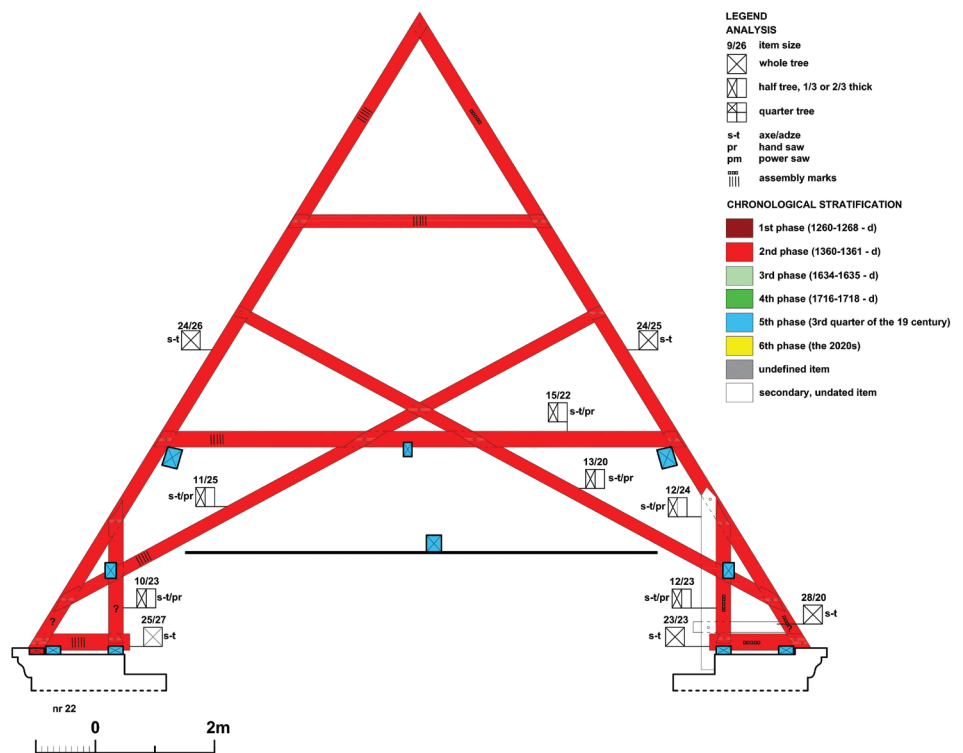

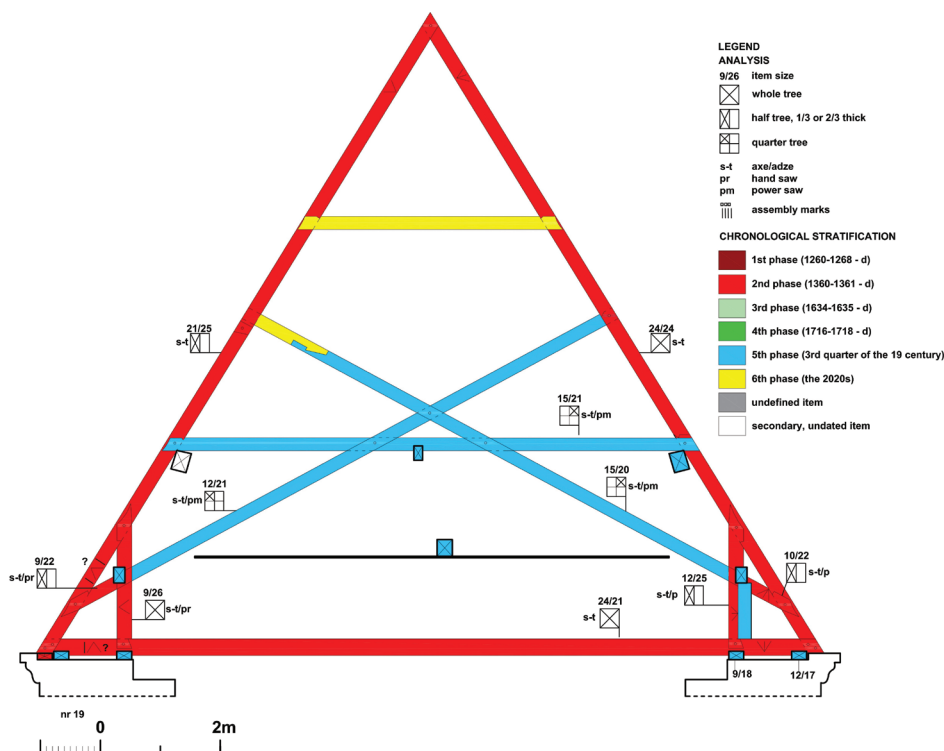

Fig. 7. Kamień Pomorski, cathedral, roof structure above the nave, paired common rafter, no. 19, analysis and stratification (elaborated by U. Schaaf, M. Prarat)

Il. 7. Kamień Pomorski, katedra, więźba dachowa nad nawą, więźar niepełny, nr 19, analiza i rozwarstwienie (oprac. U. Schaaf, M. Prarat)

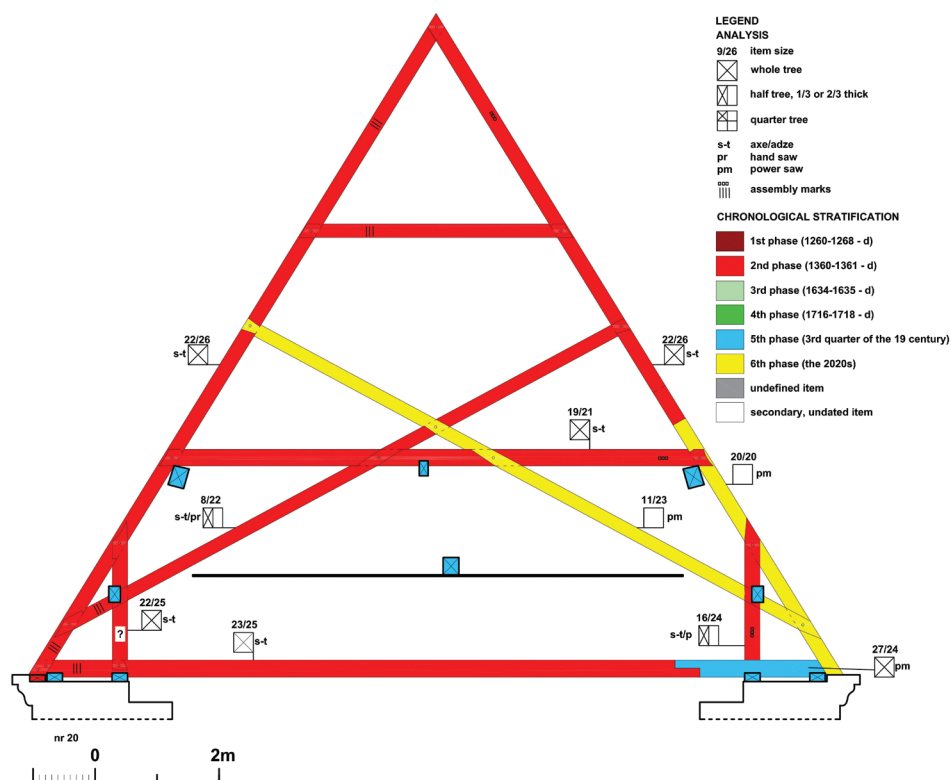

Fig. 8. Kamień Pomorski, cathedral, roof structure above the aisle, paired common rafter, no. 20, analysis and stratification (elaborated by U. Schaaf, M. Prarat)

Il. 8. Kamień Pomorski, katedra, więźba dachowa nad nawą, więźar niepełny, nr 20, analiza i rozwarstwienie (oprac. U. Schaaf, M. Prarat)

The secondary origin of the lower collar beam and intersecting passing braces (except for their lower ends) in truss 19 (Fig. 7) is evidenced, inter alia, by their treatment with a power saw on two sides, the lack of carpentry assembly marks on them and straight lap joints as carpentry joints. The passing braces were also connected to the rafters not from the timber framing side, but from the rear

side. The tie beam in truss 20 (Fig. 8) consists of two parts connected to each other by a straight lap joint, secured with a screw vertically, and iron flat bars attached to the side and also connected with screws. The short part on the north side was machined with a power saw, which allows its classification as secondary. In many fragments, the wall plates are also of a secondary nature. This is evi-



Fig. 9. Kamień Pomorski, cathedral, roof structure above the nave:
 a) reinforcement of the connection of two parts of the tie beam (principal rafter truss 20) with a flat bar, securing the principal rafter trusses with tensile-resistant anchors (19–20) above the principal rafter truss beam,
 b) connecting the sole piece with the rafter using two flat bars, joining the (secondary) upper plate with the passing brace and rafter using a flat bar (photo by U. Schaaf, M. Prarat)

Il. 9. Kamień Pomorski, katedra, więźba dachowa nad nawą,
 a) wzmocnienie połączenia dwóch części belki więzarowej (wiązar pełny 20) płaskownikiem, zabezpieczenie ankrami wytrzymałymi na rozciąganie więzarów pełnych (19–20) powyżej belki więzarowych pełnych,
 b) spięcie stopki z krokwią dwoma płaskownikami, spięcie belki (wtórnej) z zastrzałem i krokwią płaskownikiem (fot. U. Schaaf, M. Prarat)

denced, inter alia, by their connection edge-to-edge with the tie beams and sole pieces, and by their processing with a power saw. In addition to the reinforcement of the down brace zone on the northern side in truss 22 (cf. Fig. 6), replacement of individual elements or their fragments in trusses 19–20 (cf. Figs. 7, 8), and with a partial replacement of the wall plates, iron elements were introduced into the entire roof structure (Figs. 9a, b), now a bit rusty, both to protect the wooden structure against parting and to strengthen wooden connections. The treatment and joints used suggest that the changes described here occurred later, after the strengthening of the foot zone in truss 22.

In one of the passing braces in truss 19 (cf. Fig. 7) the upper end was replaced, as evidenced by its processing with a modern power saw on all sides and a scarf joint, which connects both parts of the brace. The same treatment is applied to the upper collar in truss 19, the lower part of the northern rafter and one of the intersecting passing braces in truss 20. Among other things, this treatment and the lack of assembly marks and signs of weathering make it possible to combine the assembly of these elements with the repair that has been ongoing since the end of the last decade.

*Secondary entablature with a frame
 inclined roof strengthening
 and a king- and standing queen-post structure*

A secondary entablature was inserted into the existing cross-braced collar structure slightly above the vault apex, thus creating a working platform (cf. Fig. 7). The

entablature rests sideways on the upper plates, which are in turn supported by short posts standing on the inner wall plates next to the original down braces. Secondary posts are attached to the braces with nails. They connect with the upper plates with a mortise and tenon joint without a peg or with a butt joint (Fig. 10). The beams are, in turn, connected to the upper plates by coggled joints of various shapes. The auxiliary lines needed to make the joints were made with a pencil. All the beams were additionally connected with the original passing braces and rafters with flat bars fastened with screws with square heads and nuts. The studs were mostly made of half-tree, less often of quarter-tree, first processed with an axe and an adze, and then divided with a power saw. Their average cross-section is about 11/18 cm. A whole tree processed with an axe and an adze with an average diameter of about 18/20 cm or 20/22 cm was used for the upper plates and beams.

Secondary *frames of the inclined queen post structure* stand on the entablature and support the lower collars of the original roof structure at the connection to the rafters. Each frame consists of posts, oblique, but not parallel to the rafters, an upper plate, and up braces, which stiffen the frame in the longitudinal direction at every other post. The roof strengthening is devoid of a straining beam in the transverse direction, and therefore, the upper plates and the primary rafters were fastened with screws with square heads and nuts. The posts are joined at the lower end with beams using a straight lap joint without a mortise, and at the upper end with wall plates using pegged tenon joints. The straight lap joint was also used to connect the braces with the posts and upper plates. The lap joint on both ends

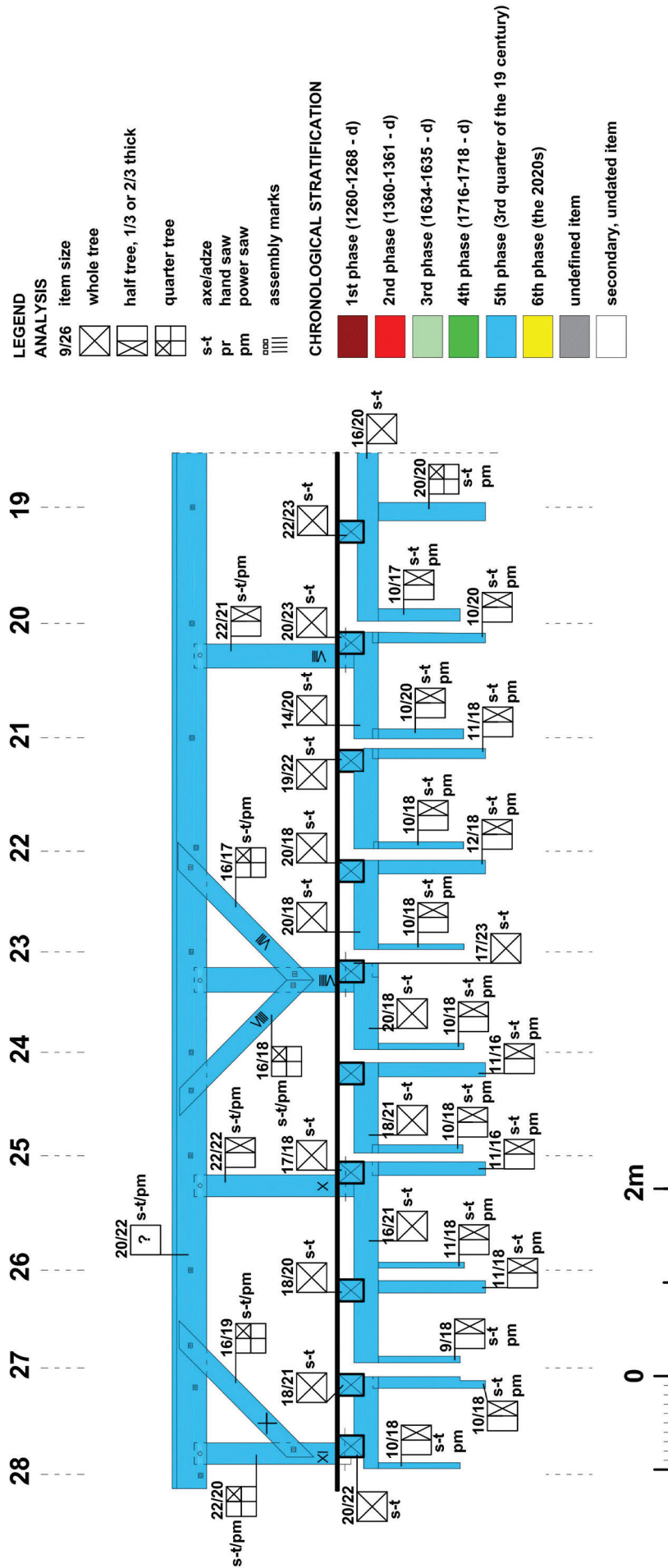

Fig. 10. Kamień Pomorski, cathedral, roof structure above the nave, eastern part, secondary entablature with a frame of the inclined queen post structure, analysis and stratification (elaborated by U. Schaaf, M. Prarat)

II. 10. Kamień Pomorski, katedra, więźba dachowa nad nawą, część wschodnia, wtórne belkowanie z ramą o stołcu leżącym, analiza i rozwarstwienie (oprac. U. Schaaf, M. Prarat)

of the brace goes into the mortise, but is not in one plane with the posts or the upper plate. Each time it is only secured with a screw. Also, in the case of frames with an inclined queen post structure, auxiliary lines were drawn with a pencil for making the joints. The studs and upper plate were made of building materials with a cross-section of about 20/22 cm. They were treated on one or both sides with an axe and an adze, and on the other sides with a power saw. The entire southern frame of the queen post structure is marked from west to east with carpentry assembly marks in the form of Roman numerals. The posts within the examined eastern fragment have marks from VII to XI, while the braces from VII to X. This means that the posts and braces were counted separately. The northern frame of the queen post structure is marked essentially in the same way. Marking was made first with a pencil using Arabic numerals, and then with a chisel using Roman numerals. This marking is a logical continuation of the system of assembly marks used in the western parts of the roof structure and proves the homogeneous nature of both secondary roof strengthening frames.

The secondary *king post structure* (Fig. 11) consists of three trusses and a longitudinal frame. Two full trusses (A-B) each consist of a king post and two long braces supporting it, a tie beam acting as a tension tie and two short braces connecting the king post with long braces. The third truss (C) is not a king-post truss, as it consists of only a tie beam and a stud standing on it. The longitudinal frame consists of king posts, an upstand binder from which an entablature is suspended above the vault, a spandrel beam, and stiffening braces. The upstand binder is situated next to the king post on the northern side. The spandrel beam on the southern side enters only 2–4 cm into the mortise made in the king post. In trusses A and B, the long braces connect to the beam and the king post by a pegged tenon with a notch. A pegged tenon joint was used to connect the braces with the king post. The beams were suspended from the king post by means of a flat bar (stirrup) fastened with screws. Moreover, this flat bar is bent at both ends and additionally fastened with small cramps. The same straight lap joints are used in the longitudinal frame as in the case of the queen post structure. They are secured with either screws or nails. The individual parts of the spandrel beams are connected to each other by a scarf joint. This connection was additionally reinforced with a nailed flat bar, and with bent ends secured with small cramps. The auxiliary lines needed to make the joints were made with a pencil. The system of carpentry assembly marks basically consists in marking structural elements in the trusses from east to west with triangular marks adjacent to thin lines – one triangle in truss B, two triangles in truss A. Both sides of the symmetry axis are additionally distinguished by line marks – one on the southern side, two on the northern side. This system of marking the king post structure is continued further on the west side and proves the simultaneous introduction of this structure in the entire roof structure above the nave. In the trusses, king and queen posts (only king posts) (about 23 × 22 cm) and braces (about 21 × 19 cm) were made from the whole tree processed with an axe and an adze, and passing braces (about 20 × 22 cm) were made of a quarter tree,

first processed with an axe and an adze, and then divided with a power saw. In the longitudinal frame, a whole tree was used for the upstand beam (binder) (26 × 26 cm), a half-tree for the passing braces (approx. 10 × 20 cm), and a quarter tree (approx. 15 × 19 cm) for the spandrel beam.

Chronological stratification

As a result of the analysis of the existing material substance, literature review, and dendrochronological research, it was possible to distinguish three construction phases: the period of construction of the roof structure and the period of two repairs, as described below. Not all items could be dated; they are listed at the end of the stratification (Fig. 12).

Phase I

– building the cross-braced collar beam roof structure (1361/1362 – d)

The architectural research has enabled the reconstruction of the original cross-braced collar beam roof structure over the nave. Researchers, as already mentioned above, have not included the roof structure above the nave in their analyses, and the completion of the nave body construction was dated differently, from the beginning to the mid-1360s [1]–[4]. The dendrochronological research shows that the trees were felled during the vegetation break of 1360/1361⁵, which has made it possible to date the building of the roof structure to the years 1361–1362 [11]. This roof structure is, therefore, a primary structure formed immediately after the completion of the masonry body.

The vast majority of the structural elements have survived from that period. The original structure in trusses 21–28 has been fully preserved.

Phase II

– repair of the roof structure at the end of the 1860s

The second phase involves the incorporation into the existing roof structure of the entablature with frames of inclined queen post and a king post structure. All these units are integrally linked and have survived in their entirety to this day. The upper plates of both roof strengthening frames bear the date 1869, which makes it possible to date the repair of the roof structure to the end of the 1860s⁶.

The type and the processing of the building material as well as the carpentry joints used lead to the conclusion that the replacement of the end of the tie beam in truss 20 on the northern side and the replacement of the lower

⁵ Nine samples were taken from the structural elements of the roof structure over the central nave, of which eight could be dendrochronologically dated. Four were taken from oak elements and four from pine elements. The latter originated from the hills of the forests along the Oder River in the Uckermark region [11].

⁶ This repair is probably a continuation of the restoration of the cathedral begun in the late 1840s under the supervision of the then Royal Conservator of Monuments in Prussia, Ferdinand von Quasta [3, p. 10].

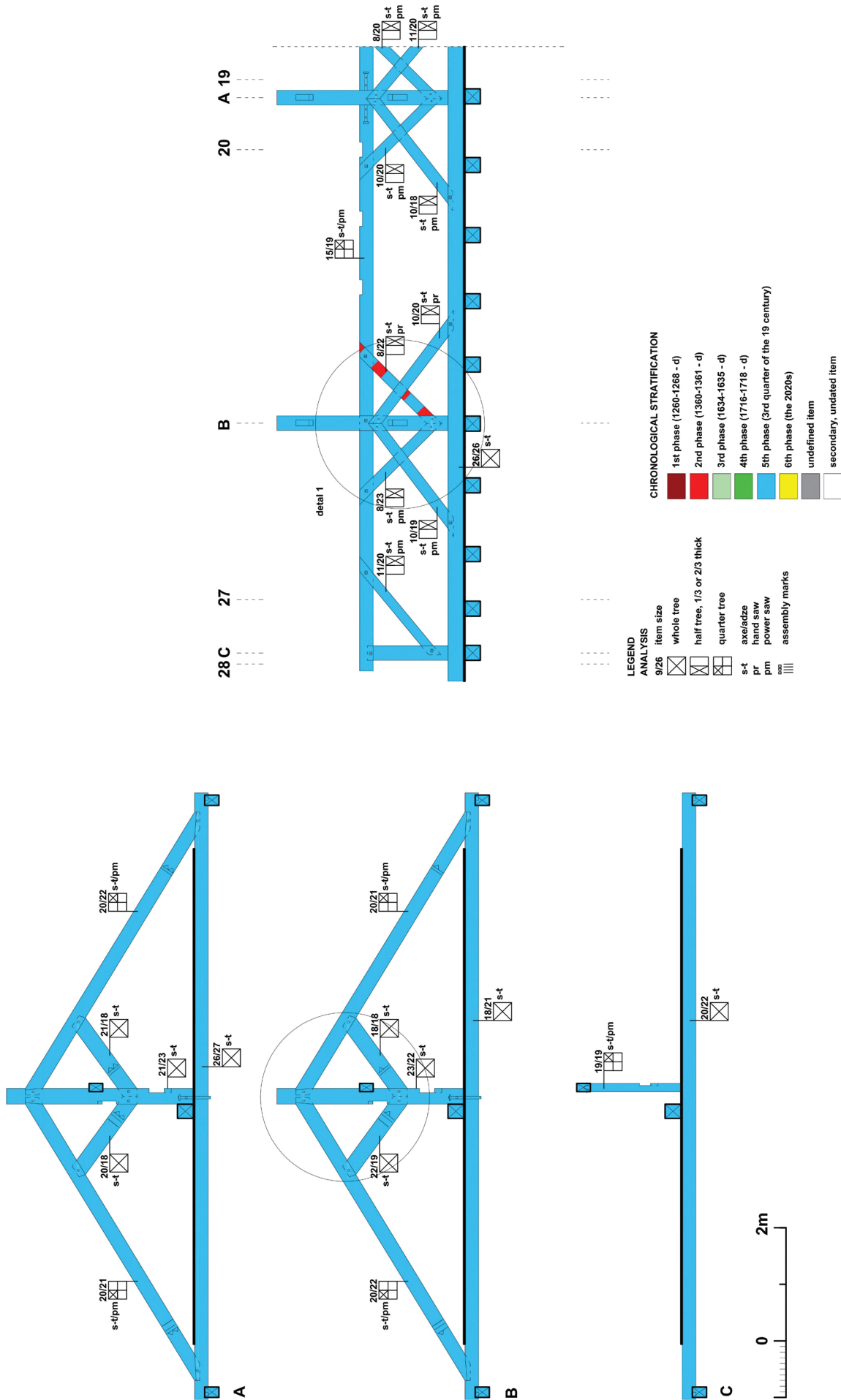
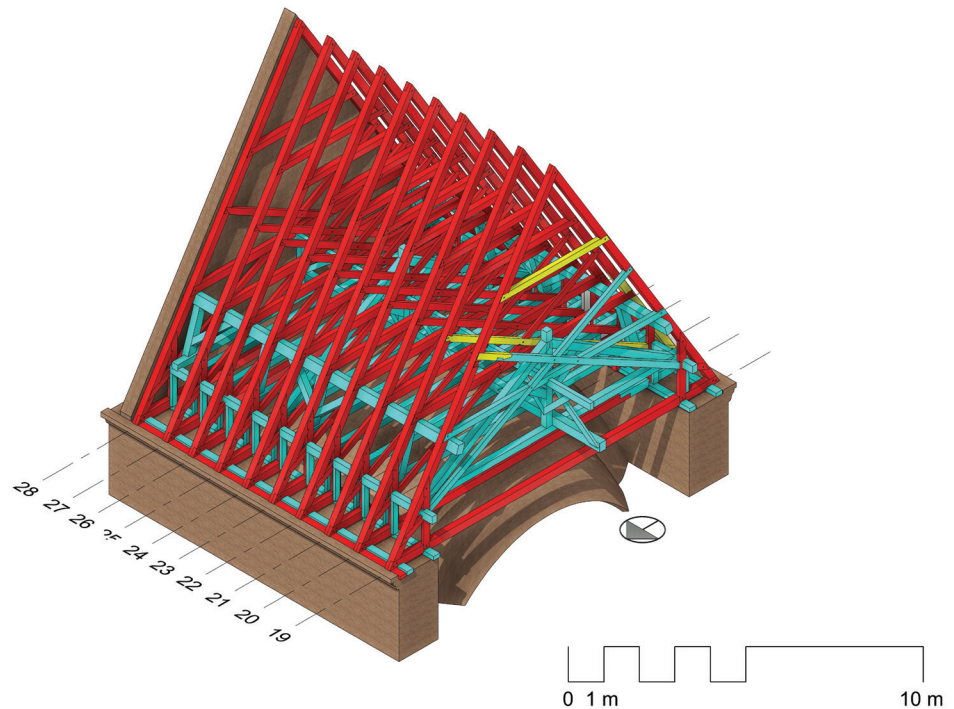

Fig. 11. Kamień Pomorski, cathedral, roof structure above the nave, eastern part, secondary entablature with a king post structure, analysis and stratification (elaborated by U. Schaaf, M. Prarat)

Il. 11. Kamień Pomorski, katedra, więźba dachowa nad nawą, część wschodnia, wtórne belkowanie z konstrukcją wieżową, wtórne belkowanie z konstrukcją wieżową, analiza i rozwarstwienie (oprac. U. Schaaf, M. Prarat)

Fig. 12. Kamień Pomorski, cathedral, roof structure above the nave, trusses 19–28, stratification (elaborated by U. Schaaf, M. Prarat, drawing by M. Kumorowicz-Brzeska)

Il. 12. Kamień Pomorski, katedra, więźba dachowa nad nawą, więzary 19–28, rozwarstwienie (oprac. U. Schaaf, M. Prarat, rys. M. Kumorowicz-Brzeska)



collar and intersecting down braces in truss 19 took place in the same period.

The period of repair should also be related to the introduction of iron elements both to protect the cross-braced collar beam roof structure against parting and to strengthen its wooden connections. This is indicated by the use of identical iron elements and the method of their fastening as in the case of entablature, the queen and king post structure.

Phase III – repair of the roof structure (2020s)

The processing of the building material with a power saw and the use of wooden dowels and screws made it possible to combine the replacement of the upper collar and the upper part of one of the passing braces in truss 19 and one passing brace and the lower part of one rafter in truss 20 with the last repair of the roof structure⁷.

Undated secondary items

The architectural research has shown that in truss 22, an additional sole piece and an additional down brace were built into the northern side. These elements have not yet been dated.

An attempt to define the meaning of the primary roof structure

The architectural research has made it possible to reconstruct the original roof structure over the nave of the cathedral in Kamień (Fig. 13). The reconstruction shows

that the structure is a collar beam one with two collars and intersecting long passing braces stretched in each truss between the rafters, and with tie beams only above the inter-span reinforcing arches (19–20, 27–28). In the remaining trusses there are only sole pieces, because the rise of the vault apex reaches into the roof structure. The angle of inclination of the rafters is 58°. The only stiffening in the longitudinal direction is wind braces running diagonally under the rafters. In the connection of individual structural elements of the roof structure lap joints of various forms dominate; coggled joints were used only in the case of connecting the tie beams and the sole pieces with the wall plates. According to the dendrochronological research, this roof structure was created in the 1360s.

This type of roof structures is a development of simple collar beam structures with identical trusses over churches with a flat ceiling or with a vault located lower than the roof structure. This development consists in introducing the vault caps into the roof structure and, consequently, the use of principal rafter trusses (with tie beams within the inter-span reinforcing arches) and paired common rafters (with sole pieces within the vaulted caps). The use of such a solution also means that only the principal rafter trusses ensure the transverse brace and anchoring of the masonry eaves walls. On the other hand, for the purpose of bracing the foot zone of the construction in the paired common rafters, it was necessary to introduce the sole pieces and vertical down braces, which together with the rafters form rigid⁸. The advantage of introducing intersecting passing braces is in additional non-movable triangles, which

⁷ Identical solutions were used in the already fully repaired western trusses (1–18).

⁸ The development of cross-braced collar beam structures from simple collar beam structures is discussed by, among other authors, Binding [10, pp. 49, 50].

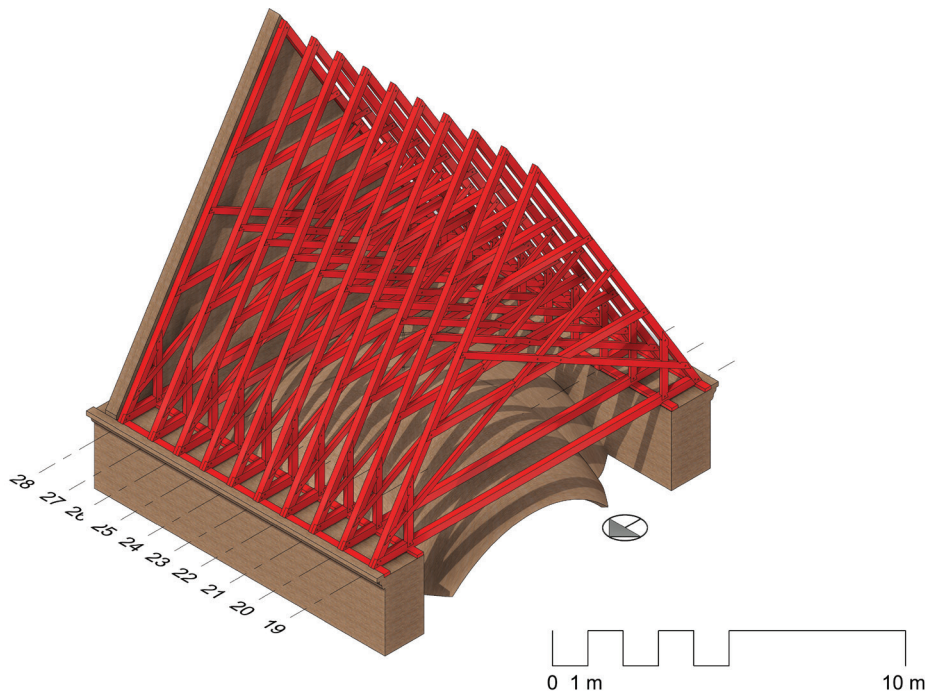

Fig. 13. Kamień Pomorski, cathedral, roof truss of the nave, trusses 19–28, reconstruction of the original cross-braced collar beam

(elaborated by U. Schaaf, M. Prarat, drawing by M. Kumorowicz-Brzeska)

Il. 13. Kamień Pomorski, katedra, więźba dachowa nad nawą, więzary 19–28, rekonstrukcja pierwotnej więźby wolnej ze ściągami (oprac. U. Schaaf, M. Prarat, rys. M. Kumorowicz-Brzeska)

provide better transverse bracing, and additional support of the rafters without loading the tie beams.

A preliminary literature review shows that this solution was applied throughout Northern Europe during the Middle Ages. There are a few known examples from France from the 12th century and from England from the 13th century. In German-speaking countries, such roof structures were common in the 2nd half of the 13th and throughout the 14th centuries [10, pp. 63–82], [12, pp. 103–105]. In the territory of present-day Poland, the solution of using the cross-braced collar beam roof structure from before the 15th century is known only from Kamień Pomor-

ski⁹, which makes it possible to assign to it exceptional significance both in the historical aspect and from the point of view of the craft of carpentry.

Translated by
Edward Maliszewski

⁹ Neither in the above-mentioned works concerning historical roof structures in Poland [7], [8], nor in works covering only certain regions/ areas of Poland, or individual cities of Poland, is there any mention of cross-braced collar beam structures [13]–[19]. Only Bronner describes similar solutions over St. Adalbert's Church and St. Catherine's Church in Wrocław, but he dates them not until the 15th century [20, pp. 6–8].

Acknowledgements

The authors of the article would like to thank the West Pomeranian Conservator of Monuments in Szczecin, Mr. Tomasz Wolender, for the commissioning of architectural research on the roof structure over the nave body, Dean Provost Father Dariusz Żarkowski for unlimited access

to the church, and also Krystyna Drozd, the author of the measurement and drawing inventory, of the construction design for the repair of the roof structure, and the creator of the inventory drawings, which were the basis for the architectural research.

References

- [1] Kasten F.K.A., *Beiträge zur Geschichte des Camminer Doms*, Prüfer, Berlin 1883.
- [2] Lüpke F.W., *Der Dom zu Cammin*, "Baltische Studien" 1876, fasc. 2, 1–57.
- [3] Spuhrmann R., *Der Camminer Dom*, Formazin & Knauff, Cammin in Pommern 1915.
- [4] Eggert H., *Der Dom zu Cammin*, Ohlenroth, Erfurt 1935.
- [5] Ohle W., *Do dziejów katedry w Kamieniu Pomorskim. Analiza budowlana wschodnich części romańskich*, "Materiały Zachodniopomorskie" 1959, t. 5, 331–360.
- [6] Skibiński S., *Katedra w Kamieniu Pomorskim*, Księgarnia św. Wojciecha, Poznań 2002.
- [7] Raczyński J., *Przyczynki do historii ciesielskich konstrukcji dachowych w Polsce*, Zakład Architektury Polskiej Politechniki Warszawskiej, Warszawa 1930.
- [8] Ganowicz R., *Historyczne więzby dachowe polskich kościołów*, Akademia Rolnicza im. Augusta Cieszkowskiego, Poznań 2000.
- [9] Ostendorf F., *Die Geschichte des Dachwerks erläutert an einer großen Anzahl mustergültiger alter Konstruktionen*, Teubner, Leipzig 1908.
- [10] Binding G., *Das Dachwerk auf Kirchen im deutschen Sprachraum vom Mittelalter bis zum 18. Jahrhundert*, Deutscher Kunstverlag, München 1991.
- [11] Ważny T., *Analiza dendrochronologiczna katedry św. Jana Chrzciciela w Kamieniu Pomorskim*, Toruń 2021 [manuscript in author's archive].
- [12] Eißing T., *Kirchendächer in Thüringen und dem südlichen Sachsen-Anhalt. Dendrochronologie – Flößerei – Konstruktion*, Bd. 1–2, Reinhold, Altenburg 2009.
- [13] Heyn F., *Die Danziger Dachkonstruktionen. Ihre konstruktive und historische Entwicklung*, Schwital & Rohrbeck, Danzig 1913.

- [14] Bronner J., *Zur konstruktiven Entwicklung der Dachstühle auf Breslauer Kirchen und Monumentalbauten*, Korn, Breslau 1931.
- [15] Bożejewicz E., *Drewniane konstrukcje dachowe średniowiecznych kościołów chełmińskich*, MA thesis, Department of Conservation at Nicolaus Copernicus University, Toruń 2006.
- [16] Konieczny A., *Mittelalterliche Dachkonstruktionen der Danziger Kirchen in der Geschichte des Dachwerks im Deutschordensland Preußen*, [in:] G.H. Gorning (Hrsg.), *Achte deutsch-polnische Begegnung zur Wissenschaft und Kultur im zusammenwachsenden Europa*, Danziger Naturforschende Gesellschaft, Lübeck 2007.
- [17] Gogolin M., *Więźby dachowe kościołów Pomorza od końca XIII do połowy XIX wieku. Przekształcenia typów i rozwiązań konstrukcyjnych*, Wydawnictwo Uniwersytetu Kazimierza Wielkiego, Bydgoszcz 2008.
- [18] Warchoł M., *Historyczne więźby dachowe kościołów w Warszawie*, Miasto Stołeczne Warszawa, Warszawa 2015.
- [19] Wawrykiewicz L., Skarzyńska-Wawrykiewicz M., *Katalog średniowiecznych konstrukcji dachowych na terenie historycznej Warmii*, Olsztyn 2019 [manuscript in author's archive].
- [20] Bronner J., *Zur konstruktiven Entwicklung der Dachstühle auf Breslauer Kirchen und Monumentalbauten. Ein Beitrag zur Zimmermannskunst in Schlesien*, Korn, Breslau 1931.

Abstract

The mediaeval roof structure over the nave of the cathedral in Kamień Pomorski in the light of architectural and dendrochronological research

The subject of the article is the roof structure over the central nave of the cathedral in Kamień Pomorski. Although there are numerous studies relating to the history of the construction of this cathedral or to the development of historic roof structures in general, none of them has yet included the roof structures discussed in this work. This situation and the need to repair the construction have justified the carrying out of the architectural research to learn its construction history and carpentry technique.

The research on the existing material substance in the eastern trusses, taking into account the following aspects: load-bearing structure, sides of timber framing, carpentry joints, a system of carpentry assembly marks, building material, and its processing. The results of these analyses were supplemented and compared with the results of dendrochronological research and that presented in the literature on the subject.

As a result of this research, it has been possible to establish that the chancel of the Kamień Pomorski cathedral is crowned with a cross-braced collar beam roof structure, which dates back to the early 1360s. It was strengthened in the late 1860s by additional entablature above the vault rise, and an inclined queen post structure and a king post structure. The next strengthening took place fragmentarily as part of the repair that has been underway since the end of the late 2010s. Despite its age and repairs, the original structure has survived to a great extent.

The type of the roof structure used above the nave in Kamień Pomorski – a cross-braced collar beam roof structure – served a specific construction function in the Middle Ages – the construction of a roof over a vault within the boundaries of the roof. A preliminary literature review has shown that examples of such solutions have survived in various parts of Europe to the present day, but only in a small number. In the territory of Poland, so far it is the only known example of this kind from the 14th century.

Currently, the remaining cross-braced collar beam roof structures over both arms of the transept and chancel of the cathedral in Kamień Pomorski are included in the architectural research. A wider study on this type of mediaeval roof structures, and attempts to compare the roof structures of the Kamień Pomorski cathedral against a broader background are desirable in the future.

Key words: Kamień Pomorski, cathedral, roof structure, Middle Ages, architectural research, dendrochronological research

Streszczenie

Średniowieczna więźba dachowa nad nawą środkową katedry w Kamieniu Pomorskim w świetle badań architektoniczno-dendrochronologicznych

Tematem artykułu jest konstrukcja dachowa nad nawą środkową katedry w Kamieniu Pomorskim. Istnieją wprawdzie liczne opracowania odnoszące się do dziejów budowy tej świątyni lub do rozwoju historycznych więźb dachowych ogólnie, ale w żadnym z nich nie uwzględniono omawianych w tej pracy więźb dachowych. Sytuacja ta oraz konieczność naprawy konstrukcji uzasadniły wykonanie badań architektonicznych celem rozpoznania jej historii budowlanej oraz techniki ciesielskiej.

Badania zastanej substancji materialnej przeprowadzono we wschodnich wiązarach, uwzględniając następujące aspekty: strukturę nośną, strony odwiązywania, złącza ciesielskie, system ciesielskich znaków montażowych, budulec i jego obróbkę. Rezultaty tych analiz uzupełniono i skonfrontowano z wynikami badań dendrochronologicznych oraz przedstawionymi w literaturze przedmiotu.

W wyniku tych badań udało się ustalić, że nawę środkową katedry kamieńskiej zwieńczyła pierwotnie więźba wolna ze ściągami, która pochodzi z początku lat 60. XIV w. Została ona wzmocniona w końcu lat 60. XIX w. przez dodatkowe belkowanie powyżej strzałki sklepienia, konstrukcję stolca leżącego oraz konstrukcję wieszarówą. Kolejne wzmocnienia nastąpiły fragmentarycznie już w ramach trwającej od końca drugiego dziesięciolecia XXI w. naprawy. Mimo wiekowości i napraw pierwotna konstrukcja przetrwała w dużym stopniu.

Zastosowany w Kamieniu Pomorskim typ konstrukcji dachowej – więźba wolna ze ściągami – służył w okresie średniowiecznym do konkretnego zadania budowlanego – wykonania dachu nad sklepieniem wchodzącym w jego obręb. Wstępny przegląd literatury przedmiotu wykazał, że przykłady takich rozwiązań przetrwały w różnych częściach Europy do dziś, ale tylko w małej liczbie. Z terenu Polski jest to póki co jedyny znany taki przykład z XIV w.

Badaniami architektonicznymi objęto obecnie pozostałe więźby wolne ze ściągami katedry, nad oboma ramionami transeptu i prezbiterium. Warto pokusić się o przygotowanie szerszego studium na temat tego typu więźb średniowiecznych oraz próbę zestawienia więźb katedry kamieńskiej z więźbami z innych miejsc.

Słowa kluczowe: Kamień Pomorski, katedra, więźba dachowa, średniowiecze, badania architektoniczne, badania dendrochronologiczne

