



CONTROLLING THE OPERATION OF A SHIP'S ELECTRIC POWER SUPPLY USING FUZZY CONTROLLERS

Bogdan Żak¹ , **Stanisław Hożyń²** 

Polish Naval Academy, Faculty of Mechanical and Electrical Engineering, Śmidowicza 60 Str., 81-127 Gdynia, Poland, e-mail: ¹b.zak@amw.gdynia.pl, ²s.hozyn@amw.gdynia.pl, ORCID ID: ¹0000-0002-6640-7116, ²0000-0003-1422-0330.

ABSTRACT

The paper presents dynamical models of controlling voltage and frequency of ship's electric supply set. The simulation model of synchronous generator, implemented in Matlab/Simulink, was described. For the developed simulation model, developed control systems using fuzzy controllers type P and PD were presented. Simulation research for resistance, inductive and capacitive loads were carried out for these regulators. Sample results of simulation tests are presented in the form of voltage waveforms at the output of the generator and rotational speed of the internal combustion engine for various load conditions. The conducted tests allow to assess the quality of the control process using fuzzy controllers and thus ensure the selection of the optimal solution.

Keywords:

Control, fuzzy controller, electric power supply

Research article

© 2020 Bogdan Żak, Stanisław Hożyń

This journal provides immediate open access to its content under the Creative Commons by 4.0 license.

Authors who publish with this journal retain all copyrights and agree to the terms of the above-mentioned [CC BY 4.0 license](https://creativecommons.org/licenses/by/4.0/)

INTRODUCTION

Modern power systems of vessels are designed to ensure the continuity of generation and supply of electricity to consumers and to ensure the quality of supplied energy. To meet the requirements, each ship's power supply system is equipped with automatic control systems, in which there are two regulators, one task is to regulate the voltage generated by the generator, while the other regulates the frequency. The main tasks of the control system of synchronous generator voltage is to maintain constant voltage at its terminals. Since most generators used in ships is self-excited synchronous generators wherein the coil winding is powered by its own rectified voltage generator. This solution means that excitation voltage is not constant, but decreases with increasing load. The main tasks of the control system of synchronous generator frequency is to maintain a constant frequency in both the states of static and dynamic. This is directly connected to the maintenance of constant rotational speed of generator's driving motor [6], [7]. It follows that a major problem in the design of this type of system is the issue of the selection of controls systems which fulfill the requirements given to the generated electricity on ships [3]. In current solutions, these are classic controllers based on the numerical representation of input and output signals. Alternative to this approach can be fuzzy logic control systems. In fuzzy control systems, signals are represented by linguistic variables. Thanks to this, a set of rules in the form of conditional sentences is used to control the object [10]. Seemingly a departure from the sharp representation of the variable values of the regulation process in favor of a fuzzy and unclear linguistic interpretation seems to be pointless. However, observations of the surrounding world force to draw different conclusions. As evidence, one can give the behavior of a man whose action in everyday life is based on blurred premises, and yet it turns out to be effective [1],[5]. Given the above premises, the authors developed fuzzy controllers for controlling the ship's electric power supply and conducted their simulation tests. The presented work shows the results of simulation tests.

SIMULATION MODEL OF SHIP'S ELECTRIC POWER SUPPLY SET

Developing a model of the system, or the phenomenon, involves clarifying the fundamental mathematical relationships between certain physical phenomena.

At the same time it missed many details and features of real object irrelevant from the point of view of the modeling.

To consider, a mathematical model of the synchronous machine has adopted the following simplification [2, 4, 9]:

- assumed symmetry of three-phase windings of the stator and rotor,
- it is assumed that the magnetomotive force in the gap along the pole pitch has sinusoidal distribution,
- neglected hysteresis, saturation, anisotropy and eddy currents in the magnetic circuit,
- it is assumed that the operating point of the magnetic circuit is located in the linear part of the characteristics of the magnetization, which in practice means accepting fixed self-inductance values as well as cross-inductance,
- the generator is carried out without attenuating windings with the rotor pole pieces made from solid steel.

Taking into account the assumptions the equation describing the dynamics of the synchronous generator can be represented as follow [2], [4]:

$$u_{sd} = \frac{dF_{sd}}{dt} - NF_{sq} + R_s i_{sd} \quad (1)$$

$$u_{sq} = \frac{dF_{sq}}{dt} - NF_{sd} + R_s i_{sq} \quad (2)$$

$$\frac{dF_f}{dt} = -\frac{1,5R_f M_{wd}}{L_{sd}L_f - 1,5M_{wd}^2} F_{sd} - \frac{R_f L_{sd}}{L_{sd}L_f - 1,5M_{wd}^2} F_f + u_f \quad (3)$$

$$F_{sq} = L_{sq} i_{sq} \quad (4)$$

$$F_{sd} = \left(i_{sd} + \frac{M_{wd} F_f}{L_{sd}L_f - 1,5M_{wd}^2} \right) \left(\frac{L_{sd}L_f - 1,5M_{wd}^2}{L_f} \right) \quad (5)$$

$$M_e = p(F_{sd} i_{sq} - F_{sq} i_{sd}) \quad (6)$$

where:

M_e – electromagnetic moment,

N – the speed of rotation of the magnetic field,

u_f, i_f –voltage and excitation current brought to the side of the stator,

F_f – the magnetic flux associated with the winding excitation, brought to the site of the stator,

p – the number of pole pairs,

R_f, L_f – resistance and self-inductance of winding excitation, brought to the site of the stator,

L_{sd}, L_{sq} – self-inductance of the stator windings in the longitudinal, and transverse axis,

M_{wd} – mutual inductance between the excitation winding, and the replacement of the stator winding in the longitudinal axis,

R_s – stator resistance,

F_{sd}, F_{sq} – space vector of the stator magnetic flux in the longitudinal and transverse axes,

i_{sd}, i_{sq} – stator current in the longitudinal and transverse axes.

Complementary to the previous system of equations is equation of moments written in the following form:

$$n = \frac{1}{J} \int_0^t (M_m - M_e) dt - T_r n \quad (7)$$

where:

M_m – mechanical torque applied from the outside, produced by the combustion engine,

J – the moment of inertia of the rotating mass,

n – the angular speed of rotation of the rotor,

T_r – coefficient of friction.

These equations correspond to the ideal synchronous machine with the adoption of the classic simplifying assumptions. On their basis, in MATLAB / Simulink, a simulation model of electric power supply set installed on ships type Oliver Hazard was developed. Its block diagram is shown in Fig.1. The simulation model developed allows changing the generator parameters using a dialog box. In addition, this model can simulate different impedance values loading the generator using the model's "z" and "cs" inputs.

Verification studies of the simulation model of synchronous generator were carried out using the presented model. Verification was made by measuring the characteristics of idling and regulatory, and compare them with the real condition characteristics [6, 8]. The simulation model developed allows changing the generator parameters using a dialog box. However, using the "z" and "cs" inputs of the model, one can simulate different types and values of load. Using the "z" input, enter the value of the load resistance, while through the "cs" input, phase shift resulting from the type of load. The test results are shown in Fig.2.

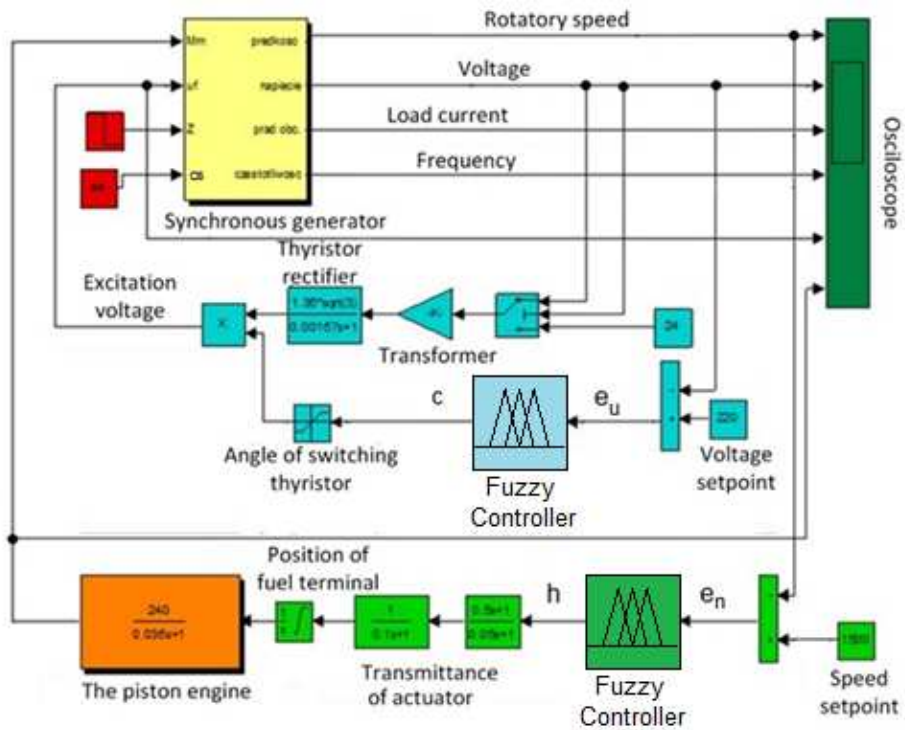

Fig. 1. Model of control system of electric power supply set

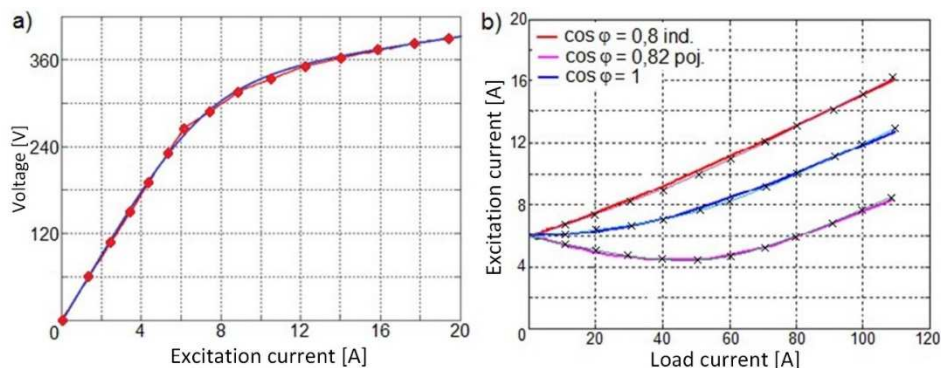

Fig. 2. The characteristics of the real generator and the simulation model: a) idle (blue color – the real generator; red dots – model), b) regulatory (continuous line – the real generator, crosses – model)

FUZZY CONTROLLER

The use of fuzzy logic occurs in simple loops, usually controlled by PID controllers. The use of fuzzy logic makes it possible to mimic the operation of a PID controller with modifications that allow obtaining nonlinear control [9] [10]. Intuitively, it seems that the use of a PID controller is the most advantageous solution. However, the amount of work involved in developing an extensive rule base, as well as the time-consuming heuristic matching of the scaling gain factors, lead to doubts as to whether the hypothetical improvement of the adjustment rates compensates for the designer's efforts.

For this reason, the work analyzes the control system with a fuzzy controllers type P and type PD to determine the suitability of each of them in the control system of a ship's electric power supply. The purpose of the developed regulators is to stabilize the rotational speed of the combustion engine driving the generator, and the excitation voltage of the synchronous generator, so as to ensure that the rated voltage and frequency of the generated voltage are maintained when the load changes [1], [7].

The synthesis started with the pre-selection of membership function of each controller, and to write the rules database [10]. The initial simulation verification was carried out, consisting in determining the correctness of assumptions for the structures of controllers prepared in such a way. Intuitive changes were made

in the shapes and arrangement of membership functions, and the rule bases were corrected. As a result of the analyzes carried out, P-type controller and PD-type controller were developed for both controlled quantities, for which the functions of belonging to sets of fuzzy controller inputs have the form as in Fig. 3 and Fig. 4

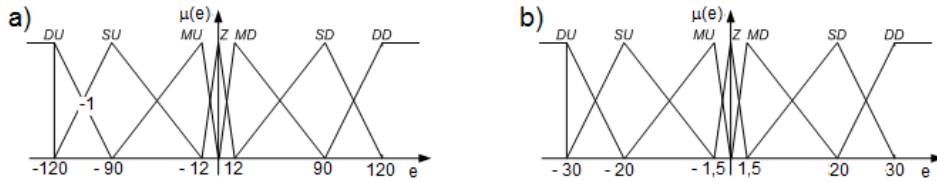

Fig. 3. The functions belonging to fuzzy sets for the regulator type P: a) speed controller, b) voltage controller.

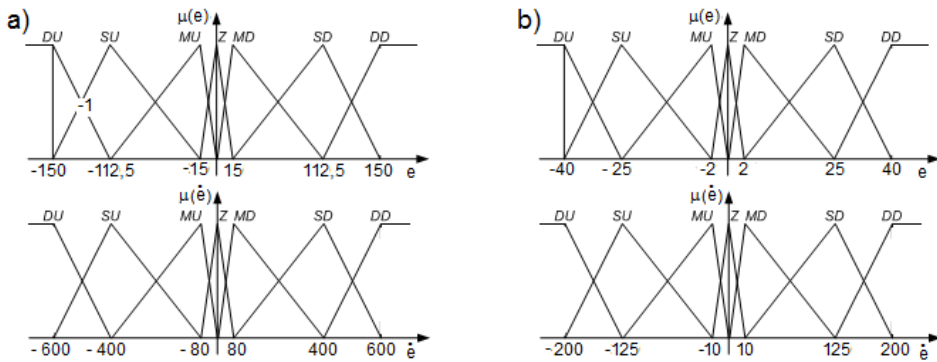

Fig. 4. The functions belonging to fuzzy sets for the regulator type PD: a) speed controller, b) voltage controller.

The interference was made on the basis of the created base of rules, whose inference principles were conducted in accordance with Table 1 for the P-type controller, and Table 2 for the PD-regulator. Interference was made on the basis of established database of rules, where the rules of conclusion were conducted according with table 1 for the P type controller, and table 2 for the PD type controller. In the tables were determined: DU – a big negative, SU – medium negative, MU – small negative, Z - zero, DD – big positive, SD – medium positive, MD – small positive. Rules in database were defined on the basis of expert knowledge.

Table 1. Database of rules for P type controller

e	DU	SU	MU	Z	MD	SD	DD
u	DD	SD	MD	Z	MD	SU	DU

Table 1. Database of rules for PD type controller

	e							
de/dt		DU	SU	MU	Z	MD	SD	DD
	DU	DD	DD	SD	SD	SU	SU	DU
	SU	DD	SD	MD	MD	MU	MU	SU
	MU	SD	MD	MD	Z	Z	Z	MU
	Z	DD	SD	MD	Z	MU	SU	DU
	MD	MD	Z	Z	Z	MU	MU	SU
	SD	SD	MD	MD	MU	MU	SU	DU
	DD	DD	SD	SD	SU	SU	DU	DU

Defuzzification of resulting membership function of conclusions rule base was carried out by the method of center of gravity according to the membership function shown in Fig.5.

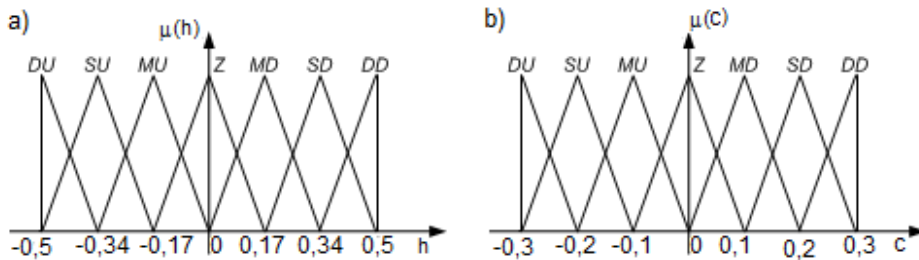

Fig. 5. Fuzzy sets used in the process of defuzzification: a) for speed controller, b) for voltage controller

SIMULATION RESEARCHES

For the developed model of the control system of the ship's electric power supply, tests of the voltage and rotational speed control system were carried out with the use of P and PD fuzzy controllers. The tests were carried out for a step change in the load of the synchronous generator from 0 to 60%, and from 50% to 100% of the rated power of various types of load. The course of the fuel rail position and excitation voltage at the step change of load was also examined. Examples of the results of the simulation are shown in the Fig. 6 to Fig.10. During the simulation tests were also carried out a comparative study of classical and fuzzy controllers. An example of the results of comparative tests is shown in Figure 11.

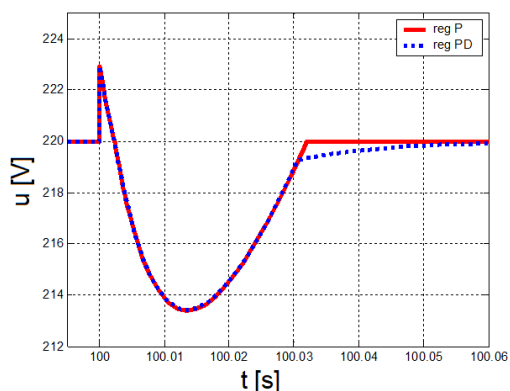

Fig. 6. Course of the generator's voltage during step change of load from 0 to 60% of rated power for fuzzy controllers P and PD for resistive load.

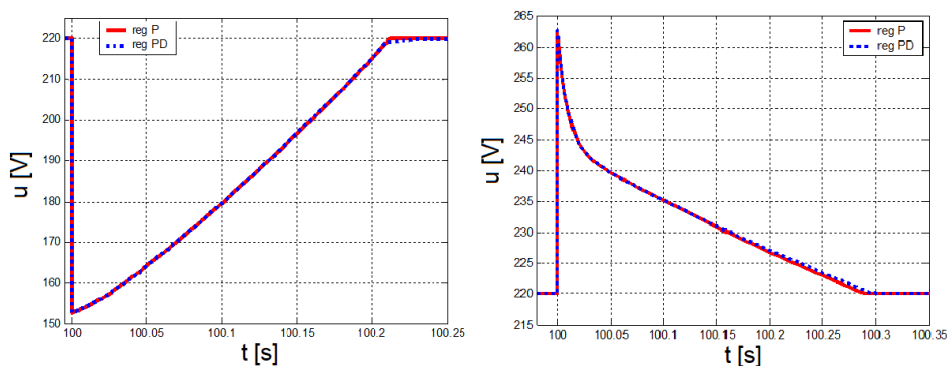

Fig. 7. Course of the generator's voltage during step change of load from 0 to 60% of rated power for fuzzy controllers P and PD: a) inductive load $\cos(\varphi) = 0,4$; b) the capacitive load $\cos(\varphi) = 0.8$.

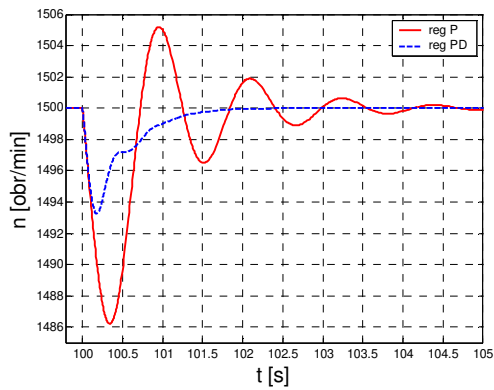

Fig. 8. The course of rotational speed during step change of load from 0 to 60% of rated power for fuzzy controllers P and PD for resistive load.

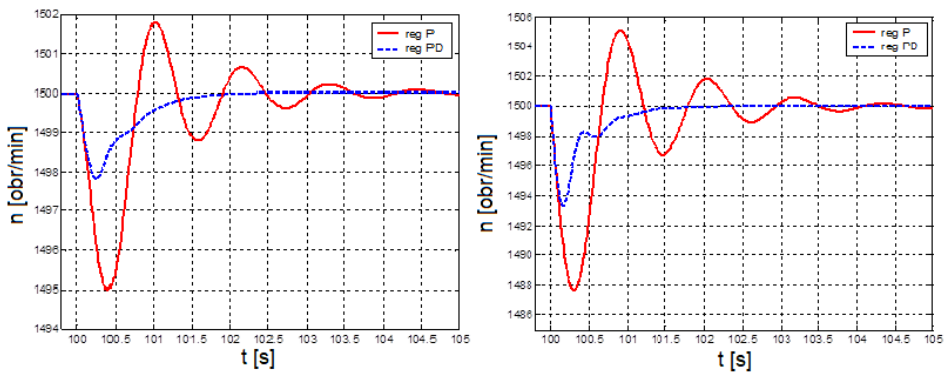

Fig. 9. The course of rotational speed during step change of load from 0 to 60% of rated power for fuzzy controllers P and PD: a) for inductive load, $\cos(\phi) = 0.4$; b) for capacitive load $\cos(\phi) = 0.8$.

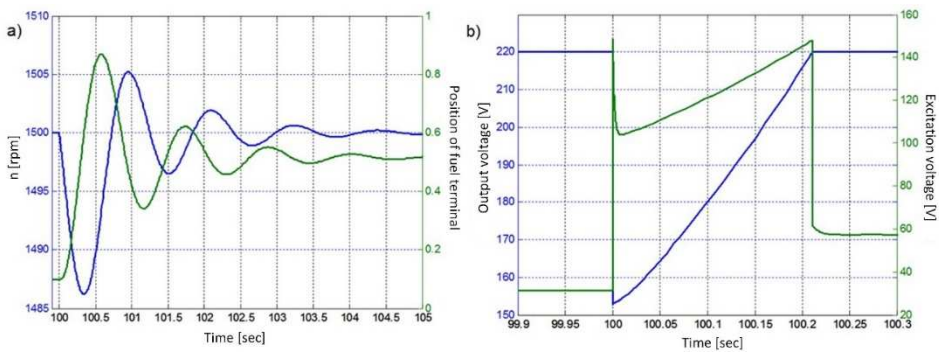

Fig. 10. The course during step change of load for fuzzy controller P: a) the speed and position of the fuel terminal, b) the value of the output voltage and the excitation voltage

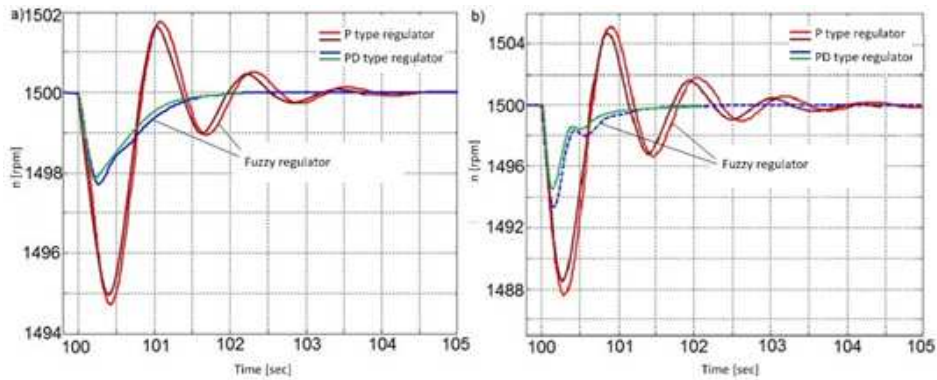

Fig. 5. The course of rotational speed during step change of load from 0 to 60% of rated power for controllers P and PD classic and fuzzy: a) for inductive load, b) for capacitive load.

CONCLUSIONS

When assessing the duration of the transition process, the advantage of the controller type PD over the controller type P is clearly visible, with fuzzy controllers ensuring good control quality in both cases. Assuming the permissible deviation from the speed setpoint ± 1 rpm, the time of practical determination of the rotational speed course at a step change in load from 0 to 60% of the rated power at a resistive load was 2.3 [s] for the controller type P, while for the controller type PD 1 [s]. For capacitive and inductive loads, these times were slightly different. For this system, the steady-state error has been reduced to zero.

Referring the obtained test results to the guidelines of Qualification Societies regarding the change of the rotational speed of the drive motor of the electric power supply when the load changes, it should be stated that the proposed solutions of fuzzy controllers fully fulfill the tasks set before it.

In the present system there was reported maximum voltage drop to 70% of the nominal voltage. Such value of squat voltage does not depend on the controller of voltage, but on the electromagnetic generator. For its value the greatest impact has rather subtransient reactance, which depends on the leakage reactance of the stator winding. A small value of the subtransient reactance results in a lower voltage drop on terminals of the generator. For this reason, examined voltage fuzzy controllers type P and PD gives the same voltage waveforms during step change in load.

The maximum voltage increase, the error in the steady state, and the duration of the transient process of applying, both classic and fuzzy controllers, are within the limits set by the Society for Qualifying.

Comparing the obtained waveforms of output signals for a step change in load, it should be stated that both classic and fuzzy controllers ensure the correct course of transition processes. These processes for both types of P and PD controllers classic and fuzzy are very similar, therefore from the point of view of control quality classic controllers can be replaced by fuzzy controllers.

The further direction of research on the use of fuzzy regulators to stabilize the electrical parameters of the ship's power supply set will be focused on the development of fuzzy PID controllers.

REFERENCES

- [1] Brzozka J., "Regulators and automation systems" [in Polish], Micom, Warsaw 2004.
- [2] Grunwald Z., "Electric drive" [in Polish], WNT, Warsaw 1987.
- [3] Kowalski Z., Tittenbrun S., Łatkowski W., "Adjusting the rotational speed of marine diesel engines" [in Polish], Marine Publisher, Gdańsk 1988.
- [4] Latek W., "The theory of electrical machines" [in Polish], WNT, Warszawa 1982.
- [5] Piegat, A., "Modeling and fuzzy control, Warsaw", Akademicka Publishing House EXIT, 2003.
- [6] Technical documentation of Diesel Generator Set Model 114J000 With GTRB Starting Air Compressor.
- [7] Wyszowski S., "Marine Electrical Engineering" [in Polish], Marine Publisher, Gdańsk 1991.
- [8] Zhang X. M., Long S. Y., "Simulation study of fuzzy PID controller for DC motor based on DSP", 2012 International Conference on Industrial Control and Electronics Engineering, 978-0-7695-4792-3/13, 2012 IEEE, DOI 10.1109/ICICEE.2012.430.
- [9] Żak B., Hożyń S., "Dynamic models of control voltage and frequency for electric power supply set" [in Polish], Science notebooks PNA, year XLVIII, no 169 K/1 2007, pp. 199-206.
- [10] Żak A., Żak B., "Selected issues of the control of marine objects" [in Polish], Ship Automation, L&L, Gdańsk 2010.

STEROWANIE PRACĄ OKRĘTOWEGO ZESPOŁU ZASILANIA ELEKTRYCZNEGO ZA POMOCĄ RE- GULATORÓW ROZMYTYCH

STRESZCZENIE

W pracy przedstawiono dynamiczne modele sterowania napięciem i częstotliwością zestawu zasilającego statku. Opisano model symulacyjny generatora synchronicznego, zaimplementowany w Matlab / Simulink. Dla opracowanego modelu symulacyjnego przedstawiono rozwinięte układy sterowania wykorzystujące sterowniki rozmyte typu P i PD. Dla tych regulatorów przeprowadzono badania symulacyjne dla obciążeń rezystancyjnych, indukcyjnych i pojemnościowych. Przykładowe wyniki testów symulacyjnych przedstawione są w postaci przebiegów napięcia na wyjściu generatora i prędkości obrotowej silnika spalinowego dla różnych warunków obciążenia. Przeprowadzone testy pozwalają ocenić jakość procesu sterowania za pomocą rozmytych regulatorów, a tym samym zapewnić wybór optymalnego ich rozwiązania.

Słowa kluczowe:

Stabilizacja, sterowanie rozmyte, zasilanie elektryczne