

Feasibility study of using various optical filters in conjunction with indoor visible light communication system

HILAL A. FADHIL^{1,*}, FERAS HASSON ALATTAR², TARIQ ADNAN FADIL³

¹Faculty of Engineering, Department of Electrical and Computer Engineering, Sohar University, Sohar 311, Oman

²Electrical and Communication Engineering, National University of Science and Technology, Muscat, Oman

³Iraqi Ministry of Higher Education, Department of Central Admissions, Baghdad, Iraq

*Corresponding author: hfadhil@su.edu.om

In modern telecommunication engineering, visible light communication (VLC) is developing a competitive advantage over the traditional RF data communication model since it uses light to transmit data. Optical filters play an important role in optical communication systems to enhance the transmission rate of bit-error rate (BER), especially as a result of noisy environments. We investigate the VLC signal performance induced by four types of filters, including Bessel, Gaussian, rectangular, and trapezoidal filters. The BER is considered an important aspect of improving optical system performance, as it indicates less crosstalk and fewer interferences within the system and is analyzed using eye diagram opening penalties. In our simulation results, the Gaussian filter performs best among these four types of filters. In this paper, a VLC indoor model is developed and simulated using an eye diagram, a bit error rate, and a transmission distance for the proposed model. The results from this study show significant improvements of Gaussian filter over other optical filters for next-generation optical networking systems, the overall BER of a Gaussian filter-based indoor VLC system is less than 9.6×10^{-15} , when the bandwidth of the optical filter is 5 nm at the quality factor of 14 dB.

Keywords: VLC, LED, BER, optical filter.

1. Introduction

In visible light communication (VLC) can be used indoors due to LEDs being able to transmit light and data wirelessly. Since the LEDs are energy-efficient and can transmit light as well as data, they are ideal transmitters for visible light communication. Gigabit-range optical fibers with low attenuation conditions were developed relatively quickly, enabling fast transmission of data, lasers and LEDs have been used more and more in high-speed lighting as a result of a huge advance in lighting technology. Today's, VLC system is proposed using the LEDs source which has been utilized in

different approaches such as indoor VLC, radio over VLC, and VLC backhaul wireless outdoor systems [1-5]. It became necessary to have data centers to store data and transfer data as a cloud computing center for data transfer and data management. Bandpass filters used to transmit the entire optical broadband spectrum were key factors driving the higher throughput data transfer capacity with limited bandwidth. The VLC applications require optical filters to ensure limited bandwidth transmission, reliability, profitability, and exceptional performance. To increase transmit power and resolution, filters can filter out all unwanted wavelengths while passing only the necessary wavelength output. With optical filters, a system can be more accurate and stable. In optical filters, power is transmitted within a specific wavelength level only, while the rest is removed. An optical filter function in single channel transmission is to separate the channel information from added noise. There are many types of noise, but white noise would be one of the most common, since it has a constant power level in the spectrum. Signal-to-noise ratio (SNR) can be improved by selecting the wavelength channel with an optical filter. This preserves useful information while filter out most of the noise. Besides that, filters can be used to significantly improve performance of VLC systems by reducing optical loss, crosstalk, polarization and temperature sensitivity. There are two important factors that can be used to control the filter transfer function, namely the full width at half maximum (FWHM) of the filter and its flat top, which is often called ripples that occur in the transmission function of filters orders, according to the group delay. The normalized Bessel filter of high order, in this case, is an optical filter with a constant and varying group delay at center frequency. Increasing the order of the filter produces a Gaussian transfer function, and the delay is constant regardless of the frequency. The characteristics of other filters, such as trapezoidal, have a smaller FWHM, and so can be simulated by a Bessel filter of appropriate order. There are various kinds of optical filters, such as rectangular, trapezoidal, Gaussian, and Bessel filters. Gaussian and rectangular filters are used to provide the highest standards such as improvements in transmission bandwidth, and received the optical power signal with high SNR. Higher filter order such as Bessel filter (more complex circuits) is used to control the spectral crosstalk of light with different wavelengths and low optical loss. Trapezoidal filter which has low FWHM is suitable for low bandwidth transmission. High optical loss, polarization, and temperature behavior make it suitable for optical sensor application. Hence, to choose the optimal filter, we investigated different types of optical filters needed to overcome the main problems which we faced, such as longer transmission distance, lower received power, and minimum bit-error-rate (BER). An example of a filter that is commonly used to enhance systems is a bandpass filter [5-7]. Our research aimed to determine the most appropriate bandpass filter for the proposed VLC applications by demonstrating different wavelengths at the receiver part via an array of LEDs and a bandpass optical filter.

This paper is organized as follows. In Section 2, a brief review of LED-based VLC technology. Section 3 focuses on the design methodology employed to improve the BER utilizing various optical filters. Section 4 lists the various results obtained. In Section 5, the conclusions are presented.

2. Recent LEDs based VLC technology

There are two types of light source which is usually recommended in the VLC manufacturing the white color and yellow color, the yellow phosphor-based illumination is considered economical. However, it has a long lifetime and is widely available. Table 1 presents the LED types based on application, price and bandwidth for indoor VLC real-time industrial usage, including PC-LED [2], RGB LEDs [3], and micro-LED [4]. Several techniques have been explored in previously published articles to enhance the modulation bandwidth of LEDs; these include multi-layer reforming within quantum wells, varying the width of the LED-active layers, or altering the RC structure [2-5].

Table 1. LED types.

| LED technology | Bandwidth | Price | Application |
|--------------------------------|-------------|--------|--------------------------------|
| Organic, light emitting diodes | 1–5 MHz | Medium | Illumination |
| Phosphor-coated (PC) LED | 3–5 MHz | Low | Illumination and communication |
| RGB LED | 15–35 MHz | High | Illumination and communication |
| Resonant cavity (RC) LEDs | ~100 MHz | High | Communication |
| Micro | 350–900 MHz | High | Sensing and communication |
| GaN nano | ~1 GHz | High | High-speed communication |

The optical filters are part of the VLC system, and the signal is transmitted via the optical VLC channel before being filtered and displayed by the spectrum optical analyzer (SOA). In our simulation model, the light source is a LED source with a variety of power levels according to the environmental conditions under the line of sight (LOS). In the next step, the signal is reconstructed using the optical filter. There are a variety of optical filters that can be implemented, including Gaussian optical filters, Bessel optical filters, trapezoidal optical filters, and rectangular optical filters. Optical signals

Table 2. Proposed optical filters transfer function.

| Optical filter type | Transfer function $H(f)$ |
|---------------------|---|
| Gaussian filter | $\propto \exp \left\{ -\ln \sqrt{2} \left[\frac{2(f - f_0)^{2N}}{B} \right] \right\}$ |
| Bessel filter | $\propto \frac{d_0}{B_N(s)}$ |
| Trapezoidal filter | $\propto 10^{\left(\frac{1-A}{10B - B_{0dB}} \right) (f - f_0)}$ |
| Rectangular filter | $\propto \frac{1 - R}{1 - R \exp \left[2\pi l \left(\frac{f - f_0}{B} \right) \right]}$ |

are collected via the photodetector and filtered, then transferred to the OSA (optical spectrum analyzer) for analysis, which displays an eye diagram and the BER. Table 2 presents the transfer function $H(f)$ of each filter used [5].

In the case of Bessel filters, trapezoidal filters, and rectangular filters, each of the following formulas is applied as follows: $H(f)$ is the filter transfer function, α is the insertion loss; f_o represents the filter center frequency and B_{0dB} is the zero dB bandwidth; all other sub-parameters are listed and indicated as in Ref. [5].

3. System design

Figure 1 presents the designed block diagram of a VLC system. The system is provided with three major components, which are the transmitter, channel, and receiver. Moreover, the transmitter part is used to send data signals through LEDs. The wavelength of white light is produced by combining multi-SS (solid-state) devices and unique color emitters via color assembling material [3].

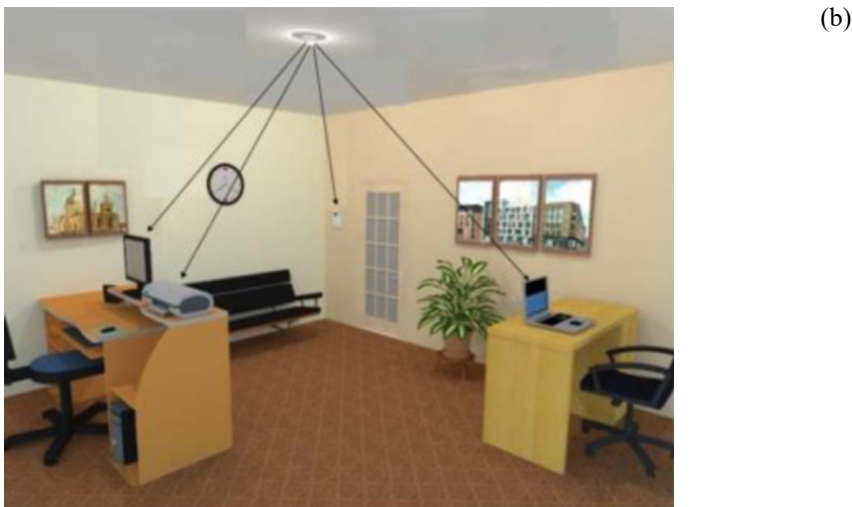
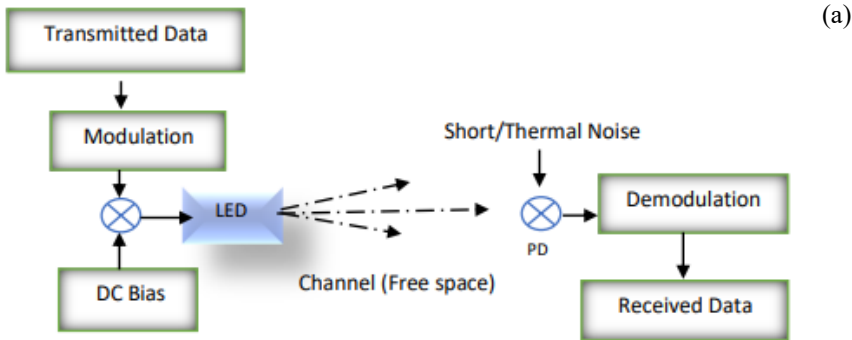

Fig. 1. (a) VLC system block diagram, and (b) indoor VLC system implementation.

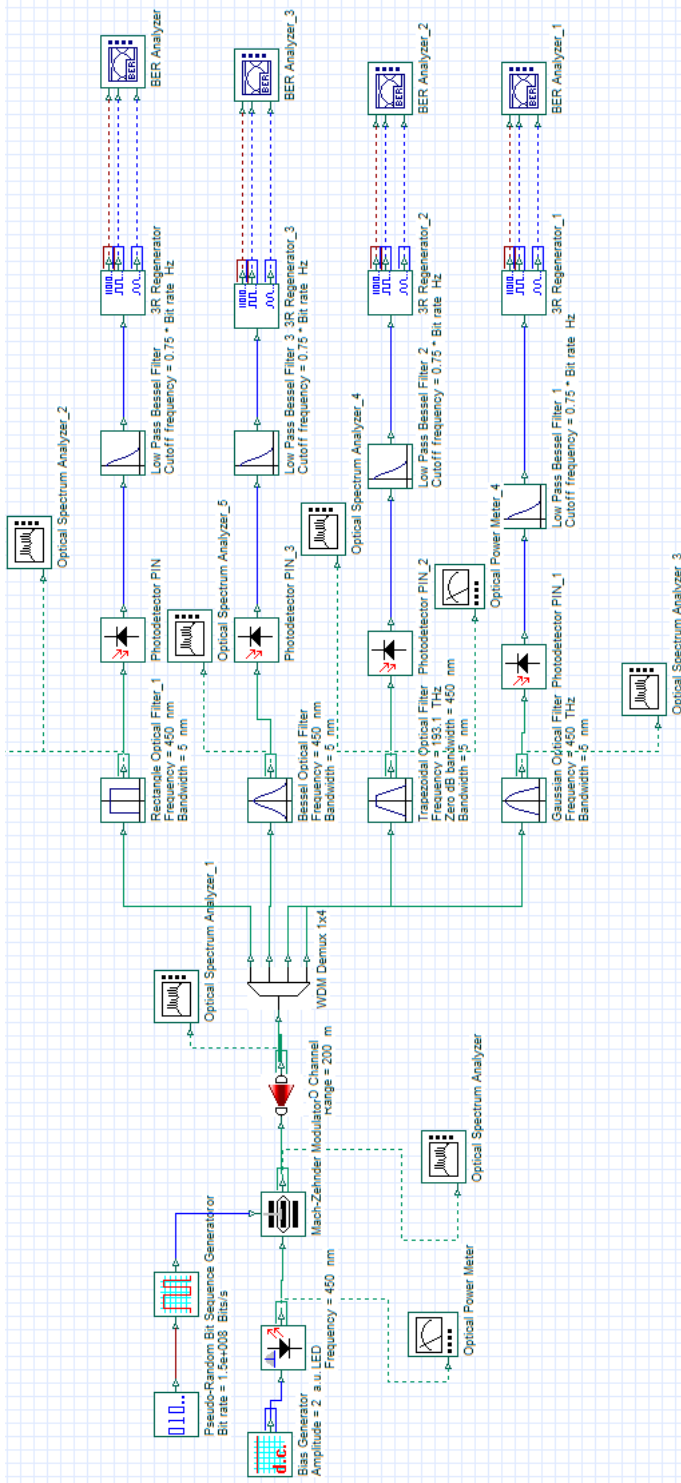

Fig. 2. VLC simulation model-based various optical filters.

The proposed system was implemented in OptiSystem™ software, and the simulated results were over 50 Mbps. Using the simplest modulation format of on-off keying (OOK) based utilizing Mach–Zehnder (MZ) modulator and pseudo-noise (PN) sequences were modeled as an input binary sequences and producing the eyes diagram plot. Figure 2 depicts the proposed simulation using OptiSystem™ software ver.15 from Optiwave™, VLC channel is divided into two paths: line of sight (LOS) and non-light-of-sight (NLOS). The NLOS scenario is defined as the multi-reflection environment which increases the distance between the transmitter and receiver and decreases the transmission rate. For typical transmission of the VLC system, maximum signal strength quality can be achieved in line of sight (LOS) conditions. The system link performance is negatively impacted by light reflected from walls for NLOS. The receiver part converts the received optical signal back to electrical, which is then filtered with a rectangular optic filter and followed by a photodiode. To remove the noise that is added to the system when traversing through a channel, a Bessel filter is applied, followed by an electrical amplifier, which exposes the original input signal. To verify the optical filters induced signal penalties, we built a simulation setup as shown in Fig. 2. The signal used in the simulation was 10–50 Mbps with an OOK modulation signal. The transmission distance is varied from 0 to 50 m. The signals were separated then by a multiplexer and detected by the PIN photodiodes. It should be indicated here that the VLC system used in the simulation was an incoherent receivers-based MZ modulator. Finally, the detected signals were analyzed by bit error rate (BER) analyzers.

The received optical power detected by the PIN photo-detector is given as

$$P_{sr} = RP_0(t)H(t) \quad (1)$$

where R is the photodetector responsivity, and $H(t)$ is the channel transfer function. While, total noise associated with LOS and NLOS is given as

$$\text{Noise power} = \sigma_{\text{therm}}^2 + \sigma_{\text{shot}}^2 + \sigma_{\text{LOS}}^2 + \sigma_{\text{NLOS}}^2 \quad (2)$$

And the optical signal-to-noise (OSNR) is expressed as

$$\text{OSNR} = \frac{\text{Signal power}(P_{sr})}{\text{Noise power}} \quad (3)$$

And the bit-error-rate is calculated as

$$\text{BER} = Q\sqrt{\text{OSNR}} \quad (4)$$

4. Results and discussion

A description of the RGB-based downlink LEDs transmission has been provided with the peak wavelengths of 469, 529, and 645 nm as the peak power levels, relative spectral outputs, and beam profiles have been set for frequency response. A standard band-

width at 1 MHz was normalized output power of 0 dBm. Therefore, the measured 3 dB bandwidths for the R, B, and G LED chips are 8.8, 7.6, and 7 MHz, respectively. Figures 3–6 show the simulated results that have analyzed the BER value as a function of transmission distance. It is seen that with the expanding transmission distance, minimum BER is increased for all types of optical filters, transmission distance causes a loss in signal strength due to the transmission distance between the transmitter and receiver.

Changing the beam of divergence (BoD) concentrator angle was used to analyze the minimum BER performance at the receiver end. Beam divergence plays an important role in determining the visible light range at the receiver. A larger BoD increases the chance of the direct LOS path dominating. In Fig. 6, the BoD was varied from 2

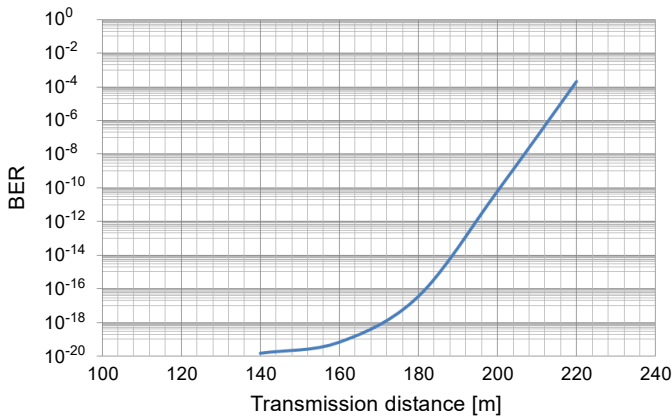

Fig. 3. Bit error rate (BER) as a function of the transmission distance of indoor VLC system.

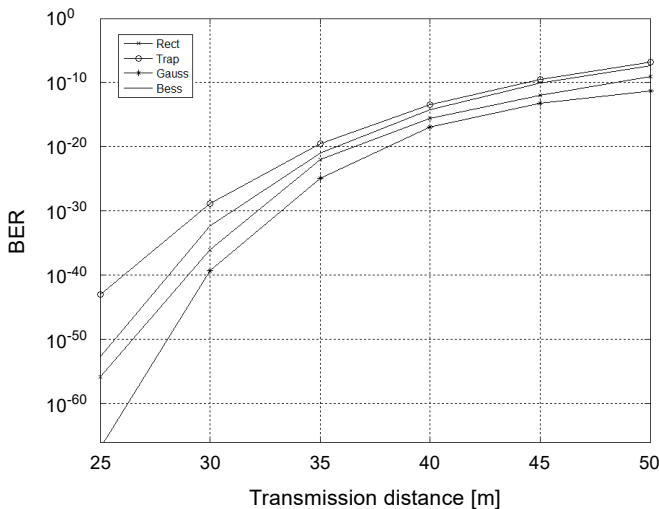

Fig. 4. Bit error rate (BER) as a function of the transmission distance of indoor VLC system using various optical filters.

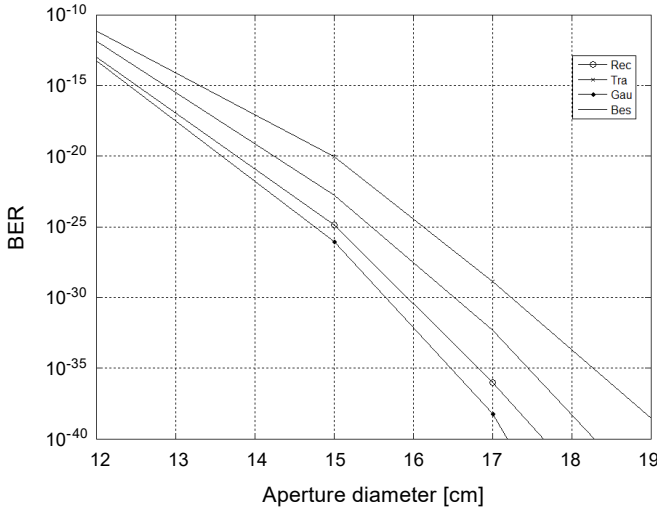

Fig. 5. Bit error rate (BER) as a function of the LED aperture diameter of indoor VLC system using various optical filters.

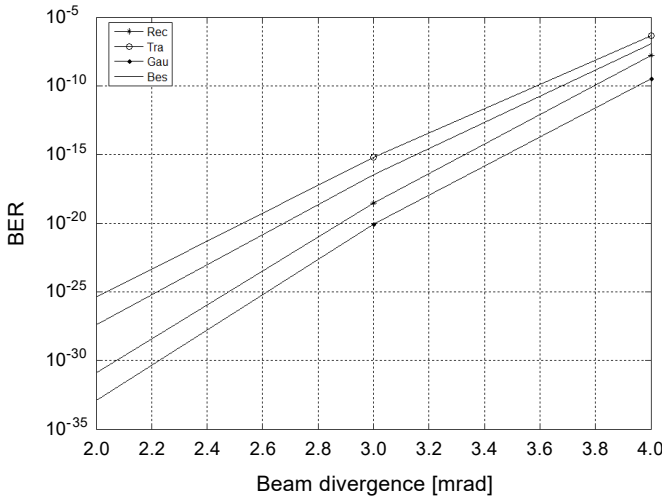

Fig. 6. Bit error rate (BER) *versus* beam divergence of indoor VLC system using various optical filters.

to 4 mrad to maintain the standard usable range. Thus, the received power varied around -12.8 to 27.74 dBm. Therefore, it is very important to adjust the BoD for high lighting intensity and for achieving higher data rates over a VLC channel. An important influence on BoD is gain, the collected intensity power, and the overall transmission rate of the system. Also, as can be seen from Fig. 7, for a transmission rate less than 30 Mbps, the trapezoidal filter has a lower BER value than all other optical filters due to its filter transfer function, it also shows that the BER increases with the increased data rate.

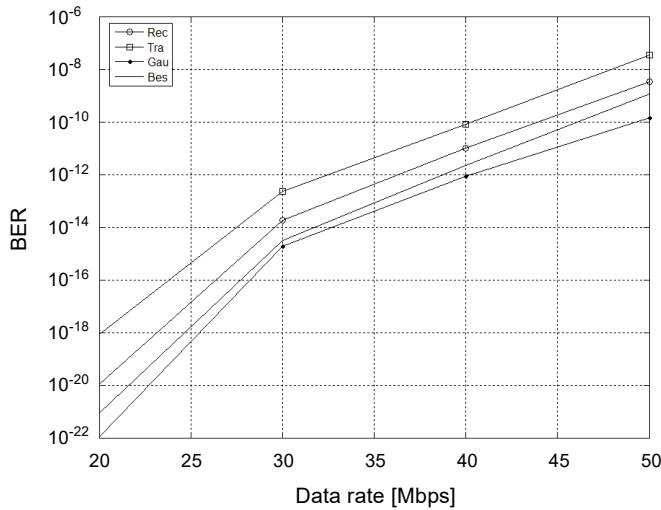

Fig. 7. Bit error rate (BER) as a function of the data rate of indoor VLC system using various optical filters.

The performance of the VLC system is highly influenced by measured received power and opening-eyes diagrams. Figure 8 illustrates the output signal generated from the comparison of various optical filters. The VLC system utilizing Gaussian filter elements has a wide opening eyes diagram, whereas a system using trapezoidal filter features has a flat bandwidth, but a smaller response and magnitude when it comes to closer eyes diagrams. Overall, there is a significant improvement in terms of BER of 9.6×10^{-15} (Fig. 8(d)) due to lower Gaussian filter bandwidth interference; the Gaussian filter followed by a rectangular filter, and Bessel filter play a major role in collecting

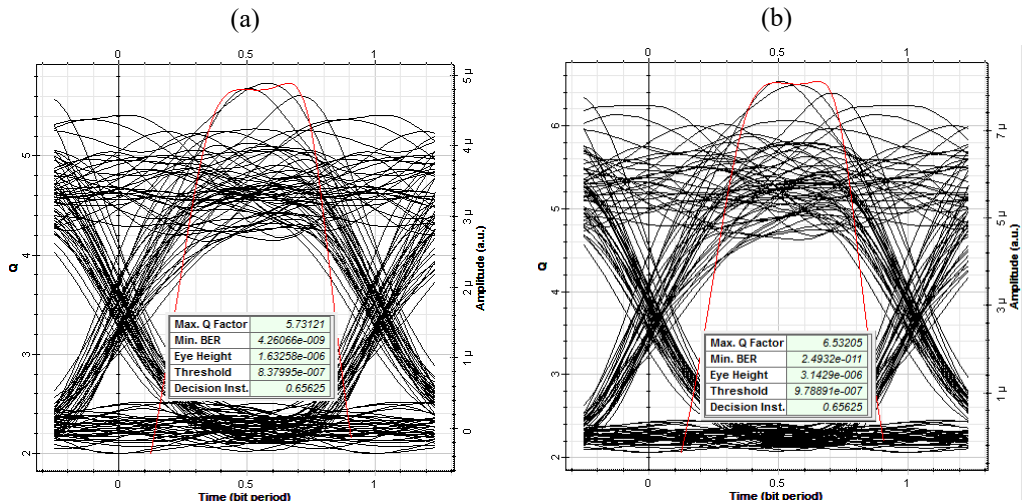

Fig. 8. Eyes diagram of indoor VLC system using (a) trapezoidal filter, (b) Bessel filter, (c) rectangular filter, and (d) Gaussian filter.

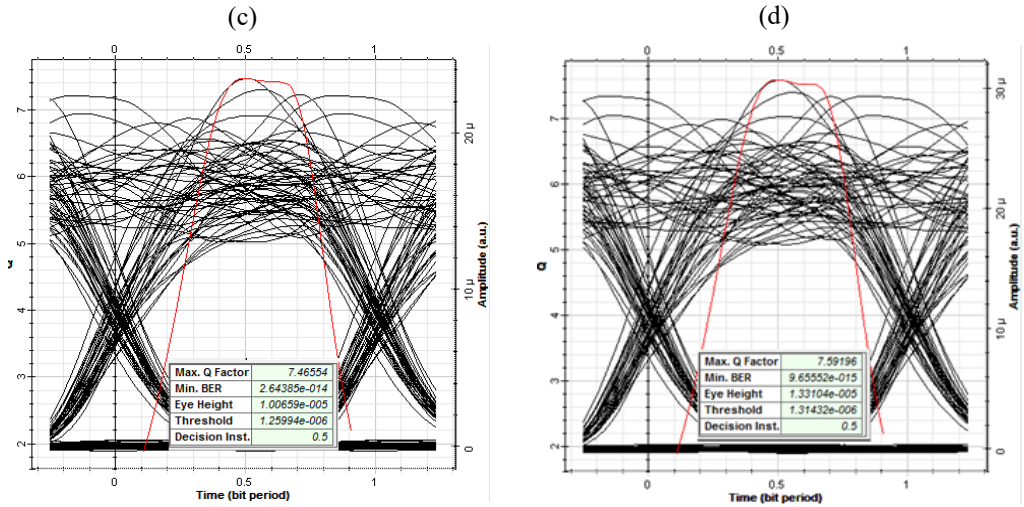

Fig. 8. Continued.

the received optical power from the VLC system. Despite reflections from surrounding objects, VLC degrades as the surrounding environment changes. Simulation parameters are mainly based on the previously published articles [7-10].

A number of VLC systems have been implemented using fiber Bragg gratings (FBG) due to their properties of adding and dropping wavelengths, and high-speed switching [11, 12]. As shown in Table 3, we simulated our VLC system using a FBG filter and compared it with other filter types in terms of BER and quality factor (*Q*-factor). Based on its main properties, the *Q*-factor for Gaussian and rectangular filters lies between 13–14 dB, revealing higher gain for Gaussian and rectangular filters. A flat bandwidth window allows for small changes in laser wavelength over time, reducing crosstalk and maintaining a constant group delay. Table 3 presents the proposed filter types.

Table 3. Filter types comparison as a function of BER and quality factor.

| Filter types | BER | Quality factor (<i>Q</i> -factor) |
|-----------------------------|-----------------------|------------------------------------|
| Previous model | 7.5×10^{-10} | 11 dB |
| Gaussian optical filters | 9.6×10^{-15} | 14 dB |
| Bessel optical filters | 2.4×10^{-11} | 12 dB |
| Trapezoidal optical filters | 4.2×10^{-9} | 10 dB |
| Rectangular optical filters | 2.6×10^{-14} | 13 dB |

5. Conclusions

The VLC technology uses a light LED transmitter to avoid radio frequency interference and to provide a large communication bandwidth. Based on a feasibility analysis of

different types of optical filters, the most recommended optical filters for indoor VLCs were identified. The VLC systems utilizing LEDs can deliver lighting intensity and data communication simultaneously. In this simulation design setup, OptiSystem™ software is used to simulate an indoor VLC system. A proof of principle has been analyzed in terms of transmission distance, BER, data rate, and eyes diagram under various parameters. The Gaussian filter is used to obtain a minimal BER of 9.6×10^{-15} at the Q -factor of 14 dB and higher received power compared with other optical filters. Furthermore, the simulated results can provide a promising solution to overcome optical filter limitations and bandwidth interference.

References

- [1] BAWAZIR S.S., SOFOTASIOS P.C., MUHAIDAT S., AL-HAMMADI Y., KARAGIANNIDIS G.K., *Multiple access for visible light communications: Research challenges and future trends*, IEEE Access **6**, 2018: 26167-26174. <https://doi.org/10.1109/ACCESS.2018.2832088>
- [2] ZHAO P., ZHAO H., *Analysis of light extraction efficiency enhancement for thin-film-flip-chip InGaN quantum wells light-emitting diodes with GaN micro-domes*, Optics Express **20**(S5), 2012: A765-A776. <https://doi.org/10.1364/OE.20.00A765>
- [3] SON T., SHIN D.S., MAGESHWARI K., KIM K.-K., PARK J., *Improved light extraction efficiency and leakage characteristics in light-emitting diodes by nanorod arrays formed on hexagonal pits*, Materials Science in Semiconductor Processing **29**, 2015: 380-385. <https://doi.org/10.1016/j.mssp.2014.08.005>
- [4] DU C., HUANG X., JIANG C., PU X., ZHAO Z., JING L., HU W., WANG Z.L., *Tuning carrier lifetime in InGaN/GaN LEDs via strain compensation for high-speed visible light communication*, Scientific Reports **6**(1), 2016: 37132. <https://doi.org/10.1038/srep37132>
- [5] GE P., LIANG X., WANG J., ZHAO C., *Optical filters design for multi-color visible light communications*, [In] *GLOBECOM 2017 - 2017 IEEE Global Communications Conference*, Singapore, December 4-8, 2017. <https://doi.org/10.1109/GLOCOM.2017.8254564>
- [6] ALATAWI A.A., HOLGUIN-LERMA J.A., KANG, C.H., SHEN C., SUBEDI R.C., ALBADRI A.M., ALYAMANI A.Y., NG T.K., OOI B.S., *High-power blue superluminescent diode for high CRI lighting and high-speed visible light communication*, Optics Express **26**(20), 2018: 26355-26364. <https://doi.org/10.1364/OE.26.026355>
- [7] KARUNATILAKA D., ZAFAR F., KALAVALLY V., PARTHIBAN R., *LED based indoor visible light communications: State of the art*, IEEE Communications Surveys & Tutorials **17**(3), 2015: 1649-1678. <https://doi.org/10.1109/COMST.2015.2417576>
- [8] KIZILIRMAK R.C., ROWELL C.R., UYSAL M., *Non-orthogonal multiple access (NOMA) for indoor visible light communications*, [In] *2015 4th International Workshop on Optical Wireless Communications (IWOW)*, Istanbul, Turkey, September 7-8, 2015: 98-101. <https://doi.org/10.1109/IWOW.2015.7342274>
- [9] KOMINE T., NAKAGAWA M., *Fundamental analysis for visible-light communication system using LED lights*, IEEE Transactions on Consumer Electronics **50**(1), 2004: 100-107. <https://doi.org/10.1109/TCE.2004.1277847>
- [10] JI R., WANG S., LIU Q., LU W., *High-speed visible light communications: Enabling technologies and state of the art*, Applied Sciences **8**(4), 2018: 589. <https://doi.org/10.3390/app8040589>
- [11] CHOW C.-W., CHEN C.-Y., CHEN S.-H., *Enhancement of signal performance in LED visible light communications using mobile phone camera*, IEEE Photonics Journal **7**(5), 2015: 7903607. <https://doi.org/10.1109/JPHOT.2015.2476757>

- [12] TOKGOZ S.C., ANOUS N., YARKAN S., KHALIL D., QARAQE K.A., *Performance improvement of white LED-based VLC systems using blue and flattening filters*, [In] *2019 International Conference on Advanced Communication Technologies and Networking (CommNet)*, Rabat, Morocco, April 12-14, 2019. <https://doi.org/10.1109/COMMNET.2019.8742364>

*Received July 5, 2022
in revised form September 26, 2022*