



THE SELECTED CHARACTERISTICS OF FUEL INJECTION IN THE SYSTEMS OF MARINE COMBUSTION ENGINE COMMON RAIL TYPE

Leszek Piaseczny, Mirosław Walkowski

Polish Naval Academy
ul. Śmidowicza 69, 81 – 103 Gdynia, Poland
tel. +48 58 6262603
e-mail: piaseczny@ptnss.pl
University of Warmia and Mazury
ul. Oczapowskiego 2, 10-719 Olsztyn, Poland
tel. +48 602833175
e-mail: mwal@interia.eu

Abstract

The injection Systems of Common Rail type are becoming widely used in marine combustion engines. The research and development of these systems aims to multi-criterial optimization of the injection process. The authors of the paper present the results of tests on the fuel supply system of the common-rail marine engine. The study was conducted on a special laboratory stand for nominal, average and minimum engine speed. For the analysis were accepted three variants of fuel supply – a single dose, two-piece dose and three-piece dose. There were presented the received characteristics of injection and discussed their most important aspects.

Keywords: *common rail, fuel injection characteristics, single dose and multi-piece dose*

1. Introduction

The need to obtain the relevant characteristics of the fuel injection process which ensure the desired course of the combustion process resulted in applying the electronic control of fuel injection into the cylinders of combustion engines. There has occurred a rapid development of systems of electronically controlled fuel injection [1 ÷ 9], which also found its place in relation to marine combustion engines. For several years, low-speed ($n = 70 \div 240$ rpm) engines from Wärtsilä RT-flex type and MAN B & W LM-E with electronically controlled fuel injection are used on ships. This last company replaced the fuel injection pump equipped with adjustable overflow valve with the electronically controlled hydraulic cylinder supplying the traditional power injectors. The Wärtsilä Company applied the tank system of Common Rail type by electronically controlling of the injector operation by means of the Wärtsilä Engine Control System – 9500 (WECS-9500), which also controls the operation of exhaust valves and motor starters, pumps operation and lubrication of the cylinders. Input values of the control system are: given and actual engine speed and angular speed of the crankshaft, type of fuel and its maximum dose limited by the setting carried out by the operator.

Medium-speed engines ($n = 240 \div 1200$ rpm) also are being equipped with the fuel injection systems of CR type. Injectors of these engines have electromagnetically controlled needle lift (for the fuel delivery less than $45 \text{ mm}^3/\text{ms}$) or traditional – hydraulic controlled.

In the high-speed engines ($n = 1200 \div 2500$ rpm) are used CR systems analogous to those used in the automotive industry. Because of the value of injection pressure and the distribution of the fuel dose into several sections (phases) are used piezo-quartz injectors.

Each of the electronic control system of fuel injection has usually the possibility of controlling both the injection advance angle, fuel dose and the distribution of dose in the injection process – in the time domain (CA). This new quality of fuel supply has been achieved not only by the electronic control system, but also through using new executive elements, such as high-pressure plunger pump, electronically controlled safety valves, hydraulic tank and electronically controlled fuel injectors.

These factors allow to a radical change in the processes of controlling the fuel injection into the cylinders and to development of optimal (e.g. according to the criterion of minimum specific brake fuel consumption or required specific brake emission of nitrogen oxides) conditions of the course of combustion process. It has become an important multi-dimensional characteristics of injection, taking into account ex. pressure in the tank, the distribution of the nominal dose into parts, time interval or crank angle (CA) successive parts of injection, etc.

The research described in [3] found that at the distribution on the pilot injection and main injection the biggest changes of total fuel dose occur at small crank angles between the successive phases of injection and at lower pressures in the tank (Fig. 1).

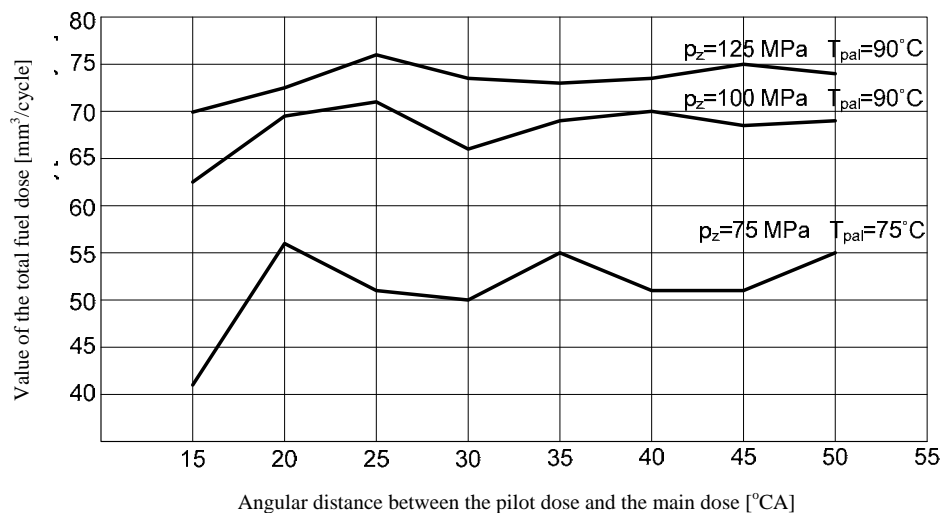

Fig. 1 Influence of distance between the beginning of the pilot dose and the main dose to the total dose at $T_w=1$ ms
 $T_1=0,5$ ms i $T_2=0,5$ ms; [3]

In these studies was found that the fluctuation of the fuel dose decreases with an increase of its total amount, which can be noticed by comparing Figures 1 and 2.

The pilot injection dose causes the pressure wave in the fuel system, which can not be suppressed before the main injection between too low angular distance between the successive phases of injection. As a result of this phenomenon (despite the continuous time of injection) there are changes in the total value of fuel dose, which course depends on the wavelength at which the injector opens.

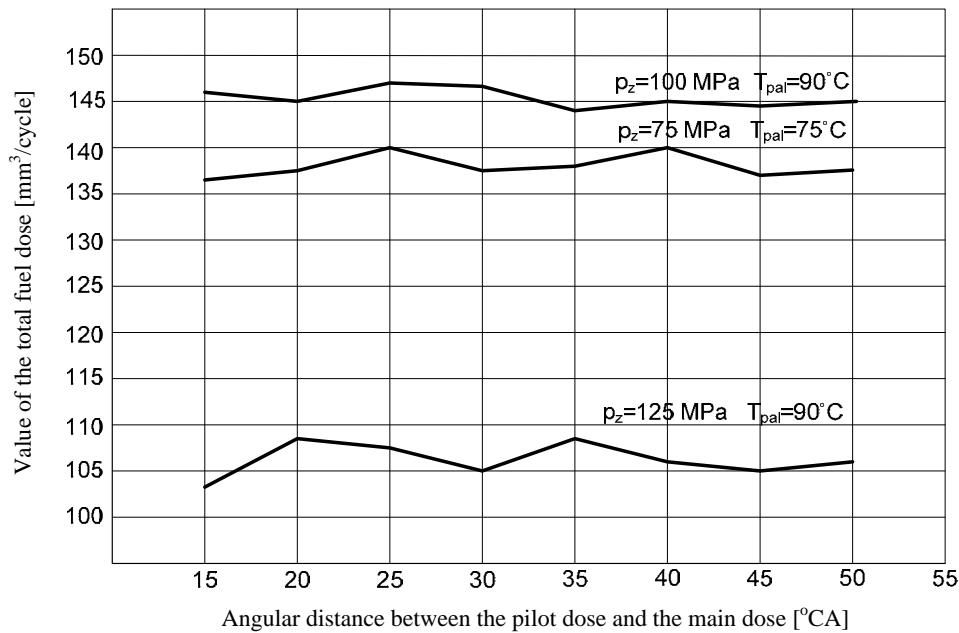

Fig. 2 Influence of distance between the beginning of the pilot dose and the main dose to the total dose at $T_w=3$ ms $T_1=0,5$ ms i $T_2=2,5$ ms; [3]

For small angles CA between the pilot dose and the main dose changes the actual beginning of the injection (Fig. 3). This is due to the fact that at the start of the main injection the needle is still in motion caused by the injection of pilot dose, and changes in pressure above and below the needle cause the advance stroke in relation to a single injection [3].

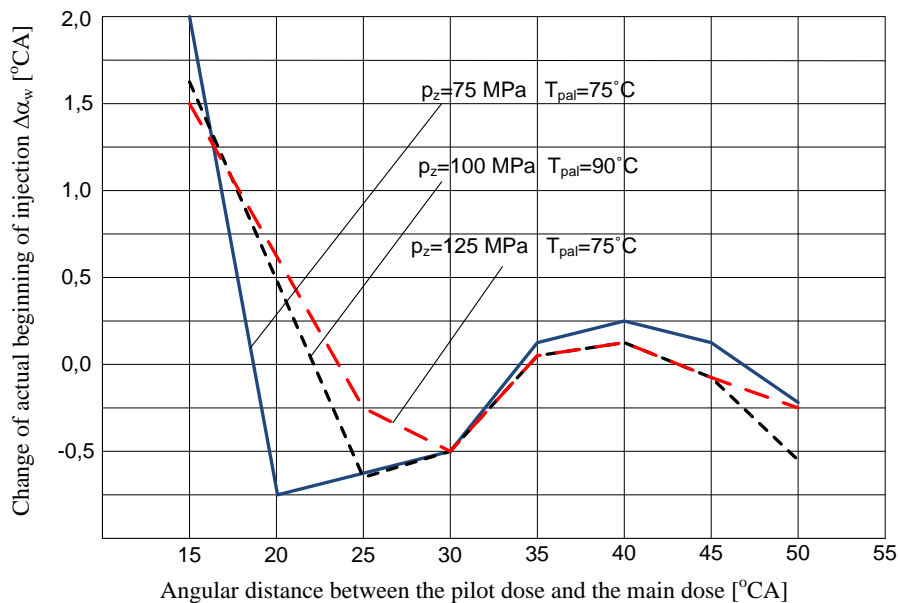

Fig. 3 Influence of distance between the beginning of the pilot dose and the main dose on the change of actual beginning of injection of main dose at $n_p = 2000$ rpm; [3]

It was established that too low angle between the pilot dose and the main dose is the main reason of reduced accuracy of fuel delivery and change of actual beginning of injection and as a result the energy and environmental indicators of diesel engine operation may deteriorate [3].

The paper [10] described the results of a mathematical model of the process of fuel injection and combustion in classical engine and equipped with a CR system. For this system were assumed

the initial injection pressure $p_{ow} = 90$ MPa, because after taking into account the course of characteristics of the pressure waveform the maximum injection pressure will be $p_{wmax} = 125$ MPa. Calculations were carried out for a constant advance angle of main dose injection $\theta = 15^\circ\text{CA}$ and constant participation of the pilot dose in the total dose of fuel $m_d = 0.6$ g / cycle.

Distribution of fuel injection on the pilot dose and the main dose significantly increased the pressure in the cylinder (Fig. 4), which is synonymous with an increase in engine power and decrease of unit fuel consumption.

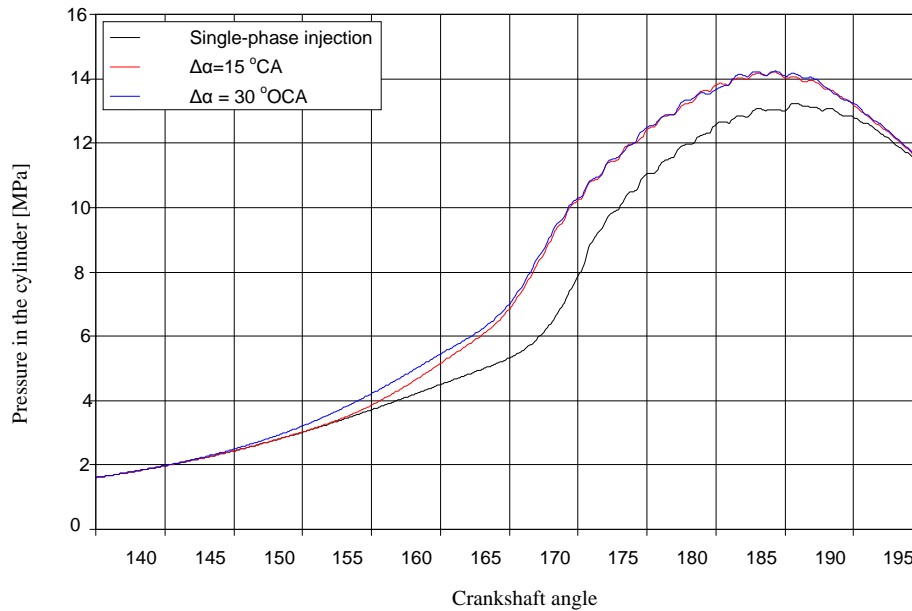
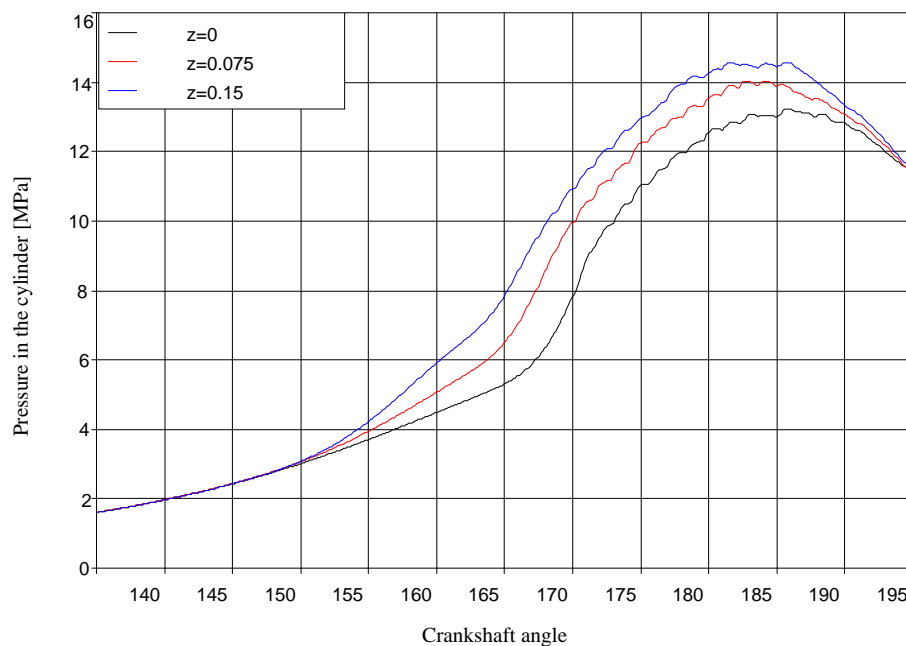

Fig. 4 Pressure waveforms of working medium at various angles between the pilot dose CA and the main dose $\Delta\alpha$ [10]

a)



b)

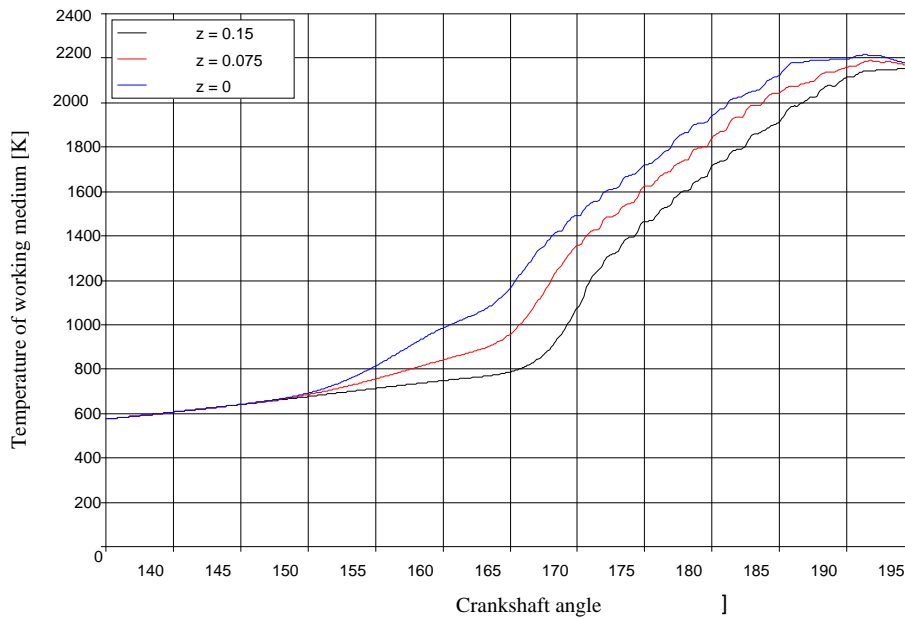

Figure 5 Influence of change of the pilot dose „z” share in the total dose of fuel on the course of: a – pressure; b – temperature of the working medium in the cylinder [10]

On the basis of obtained results of the model, it was found that increase of the pilot dose share increases the maximum pressure and the maximum combustion temperature (Fig. 5). Increasing the share of a pilot dose (as in the case of increasing the angular distance between the phases of injection) resulted in increased level of nitrogen oxides in the exhaust gas (Fig. 6).

From the given examples of the research on injection process in CR systems result that further development of the applying fuels requires knowledge of many of the characteristics of the course of injection process. Such tests are carried out in a number of national and international centers with special stands – fuel dose indicators or directly on the research engines [3,4,10,11].

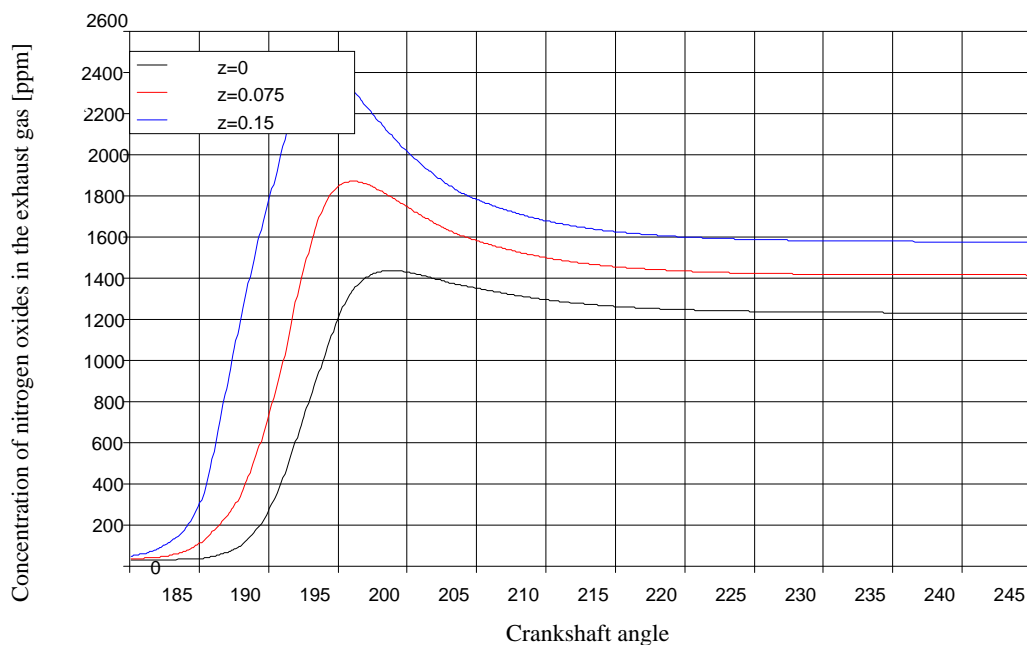

Fig. 6 Impact of changes in the pilot dose share “z” in the total dose on the concentration of nitrogen oxides in the exhaust gas [10]

The authors conducted such tests on the test stand made by a ATH team of Bielsko-Biala. This test stand with fuel dose indicator was made according to the design intent of the authors of the publication, according to the laboratory research of existing AMW dynamometer stand of engine Sulzer 6AL20/24 type.

2. Own research

2.1. Description of the test stand

The test stand, which scheme is shown in Figure 1 differs from the supply system of the engine that instead of the combustion chamber was used the fuel dose indicator. The indicator enables to measure the volume of fuel dose and record wave phenomena associated with fuel supply. The second additional device is controller which enables to program the volume of dose and multiplicity of its distribution, the time of injection and the interval between various stages of injection (design of controller allows the distribution of dose in five parts). The controller also allows the measurement and recording of: fuel pressure in the manifold, engine speed, fuel temperature in different parts of the power supply system, duration of injection angle CA, the volume of a single dose.

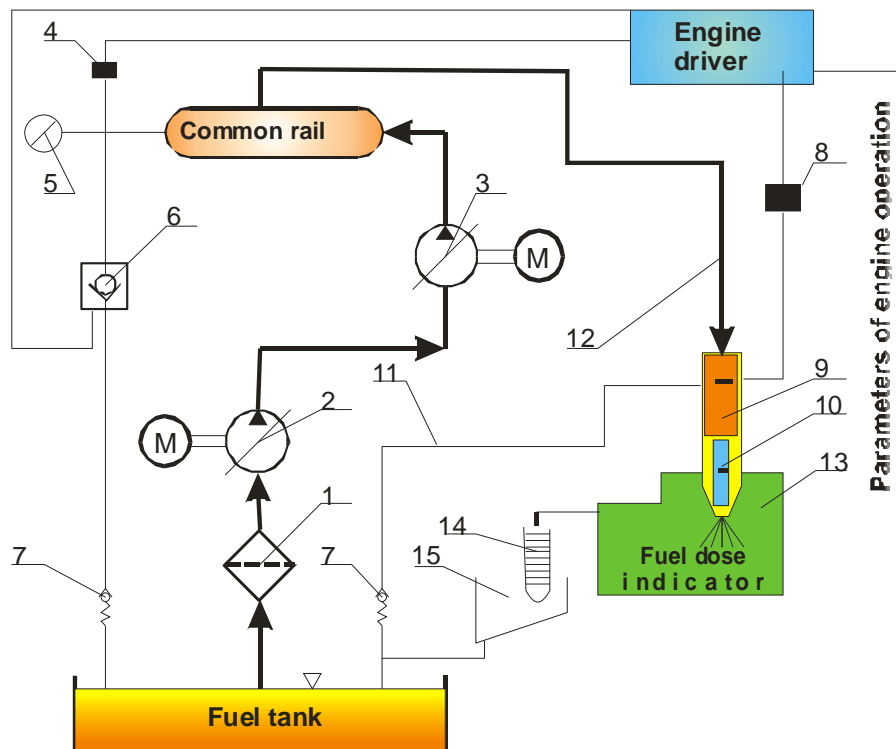

Fig. 7 Scheme of the test stand of electronic control fuel injection process: 1 – filter, 2 – low pressure pump, 3 – high pressure pump, 4 – pressure sensor in the hydraulic accumulator, 5 – pressure gauge, 6 – back-pressure valve with opening control, 7 – overflow valve, 8 – amplifier, 9 – fuel dose controlling valve, 10 – atomizer, 11 – low-pressure fuel pipe (overflow), 12 – high pressure fuel pipe, 13 – fuel dose indicator, 14 – buret to measure the amount of fuel, 15 – cumulative trough

2.2. The program of research

Research on the fuel delivery by injector depending on the distribution of the nominal dose into parts, the hydraulic pressure in the container and the injection time are conducted according to the following schedule:

- tests were carried out at three values of hydraulic pressures in the hydraulic tank having 150, 135 and 120 MPa;
- a single dose of fuel was adequate to the minimum engine speed, average and nominal - that is respectively - 850, 1025 and 1200 rpm;
- each engine speed, which was adopted for the analysis, corresponded to the maximum speed of the fuel injection time equivalent to approximately 25° CA, so for the assumed engine speed it fits in the range $3470 \div 4900 \text{ s}^{-6}$;
- for the above assumptions were adopted three variants of power supply, the first - the single dose, the second - a two-piece dose in the proportion $1/3 + 2/3$ of the nominal dose, and the third - the three-piece dose in the proportion - $0.1 + 0.8 + 0.1$ of the nominal dose;
- for the two-piece dose was adopted constant interval of valve overdrive equal to $850 \mu\text{s}$, while for the three-piece dose the interval between the pilot dose and the main dose was 700 s^{-6} and between the main dose and the supplementary dose of 600 s^{-6} – due to time constraints resulting from the completion of the full dose at the nominal engine speed.

There was used the electromagnetic injector CR with control valve with mass expenditure of approximately 0.1054 g/cycle . As was shown by preliminary studies, if the time interval between doses is less than $700 \mu\text{s}$, the fuel flow through the nozzle needle is not fully closed.

2.3. The results of research

Graphs which is shown in Figure 8 to 16 presents the qualitative relations between basic parameters of the fuel injection in the presented system CR for assumed engine speed, hydraulic pressure in the tank and time intervals for the completion of fuel supply process of considered marine engine.

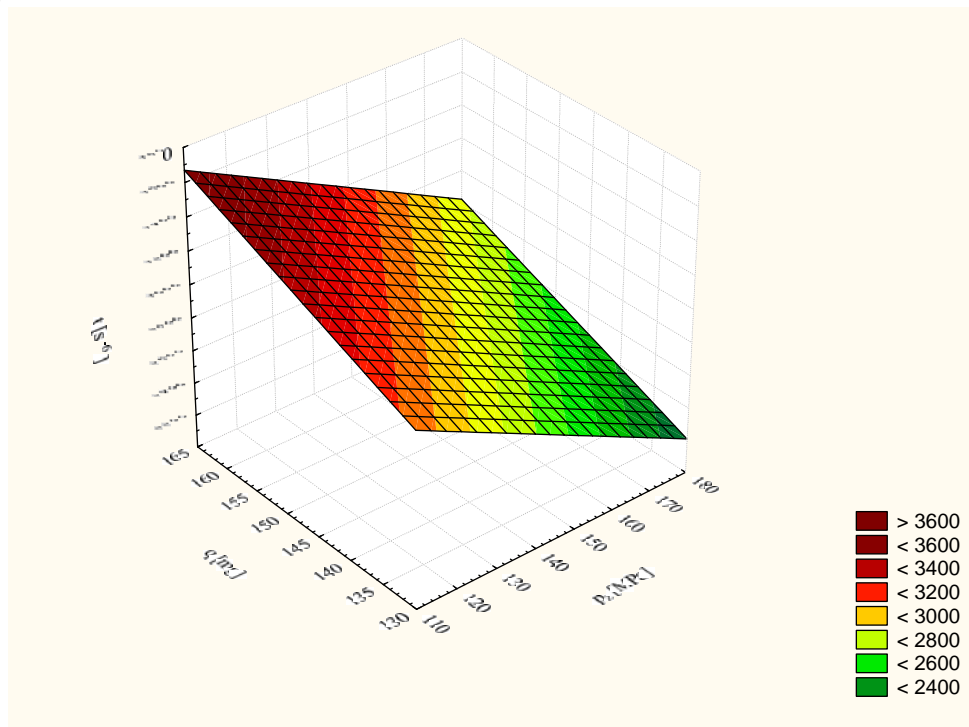

Fig. 8 Dependence of the nominal fuel dose q_{tank} on the hydraulic pressure p_2 and the total time of injection t for a single fuel dose

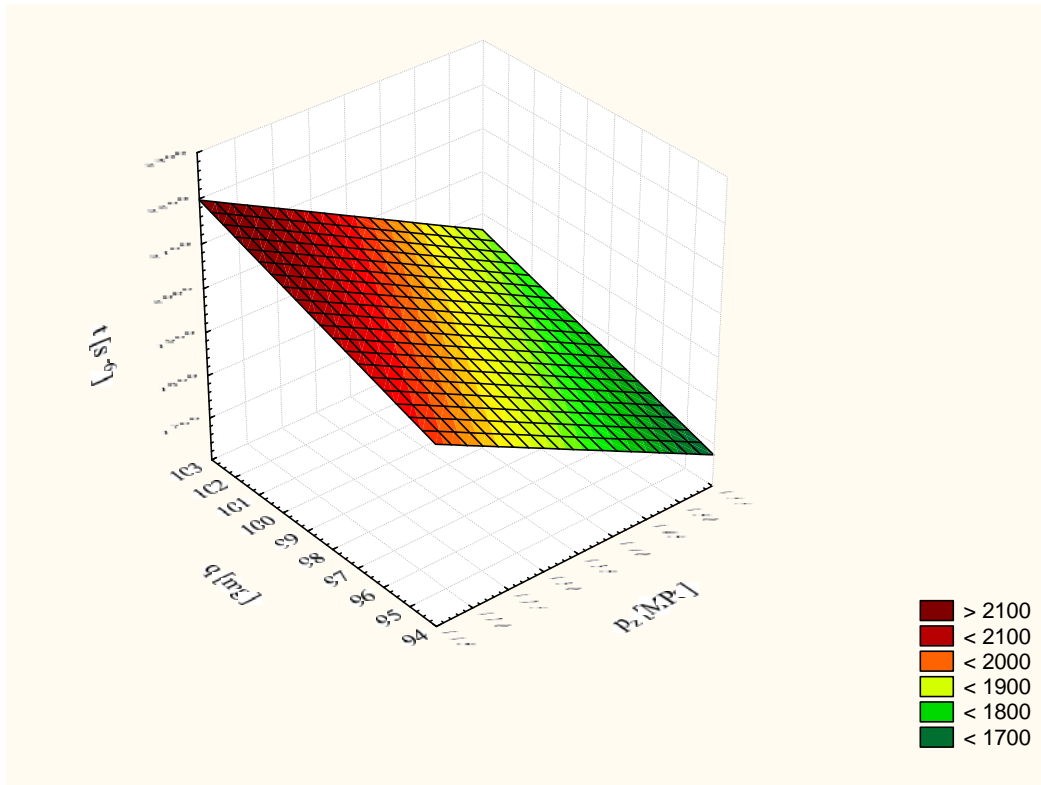

Fig. 9 Dependence of the average fuel dose q on the pressure in the tank hydraulic p_z and the total time of injection t for the a single fuel dose

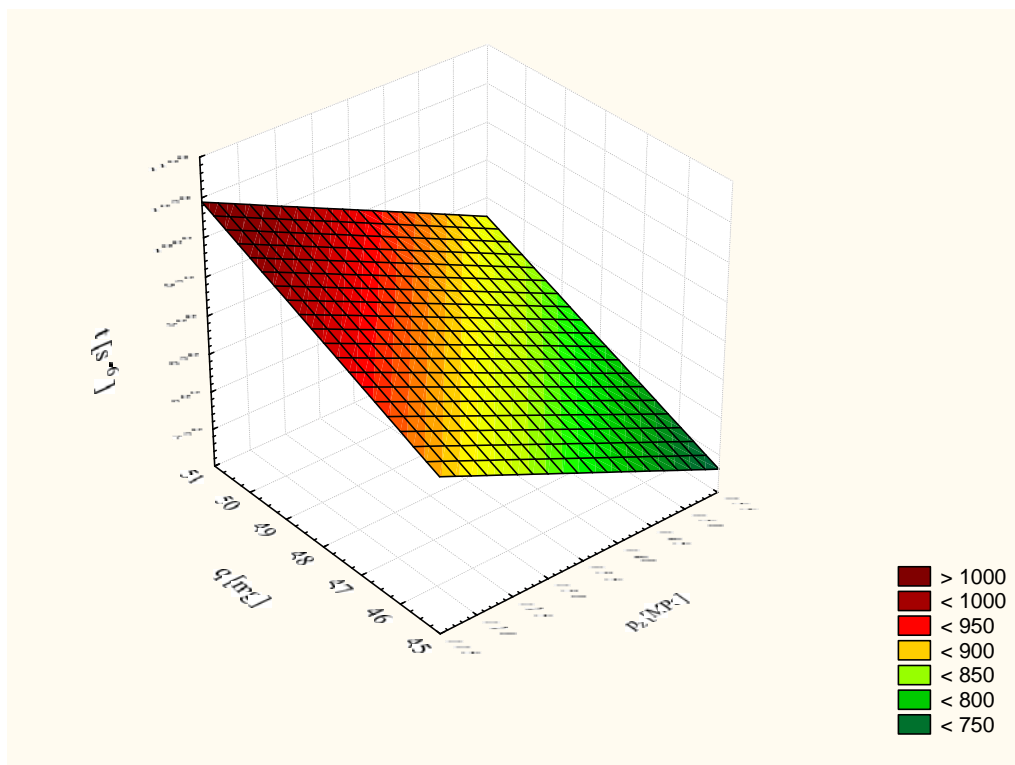

Fig. 10 Dependence of the minimum fuel dose q on the pressure in the hydraulic tank p_z and total time of injection t fuel for a single dose

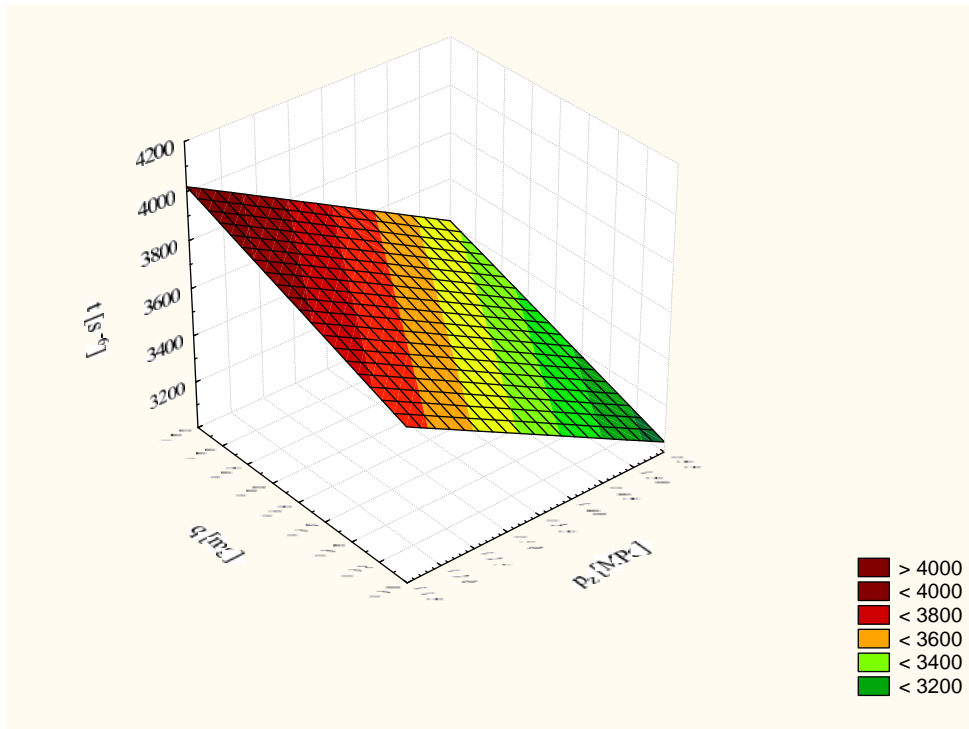

Fig. 11 Dependence of the nominal fuel dose q on the pressure in the hydraulic tank p_z and the total time of injection t for the two-piece fuel dose

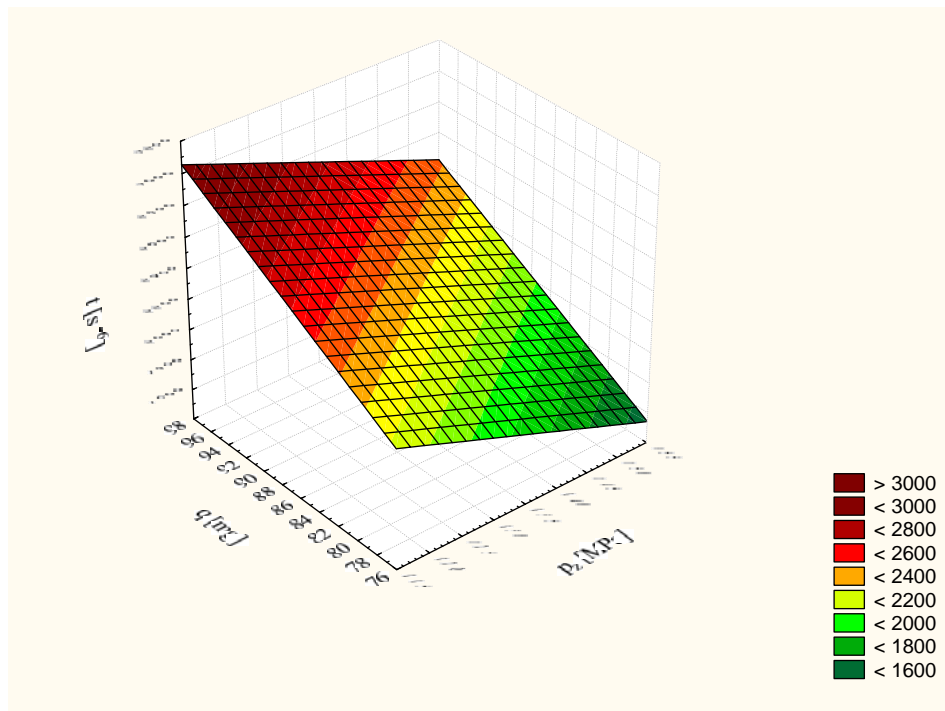

Fig. 12 Graph of dependence of the average fuel dose q on the pressure in the hydraulic tank of p_z and the total time of injection t for the two-piece fuel dose

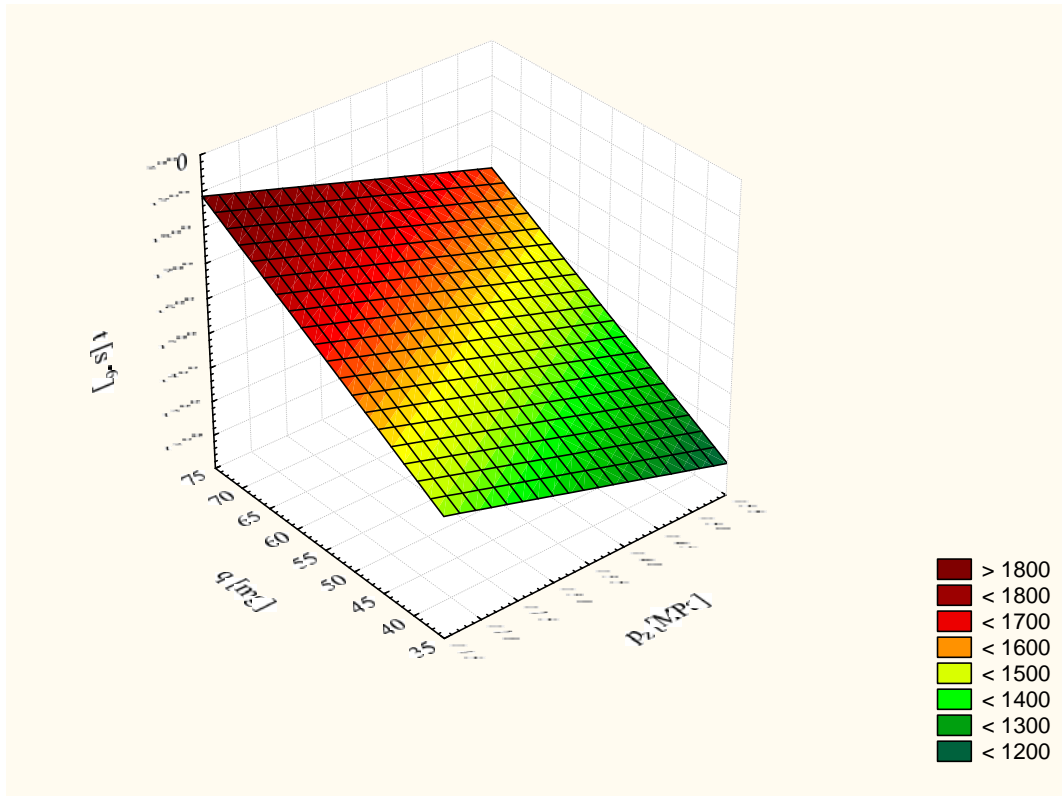

Fig. 13 Dependence of the minimum fuel dose q on the pressure in the hydraulic tank p_z and the total time of injection t for the three-piece fuel dose

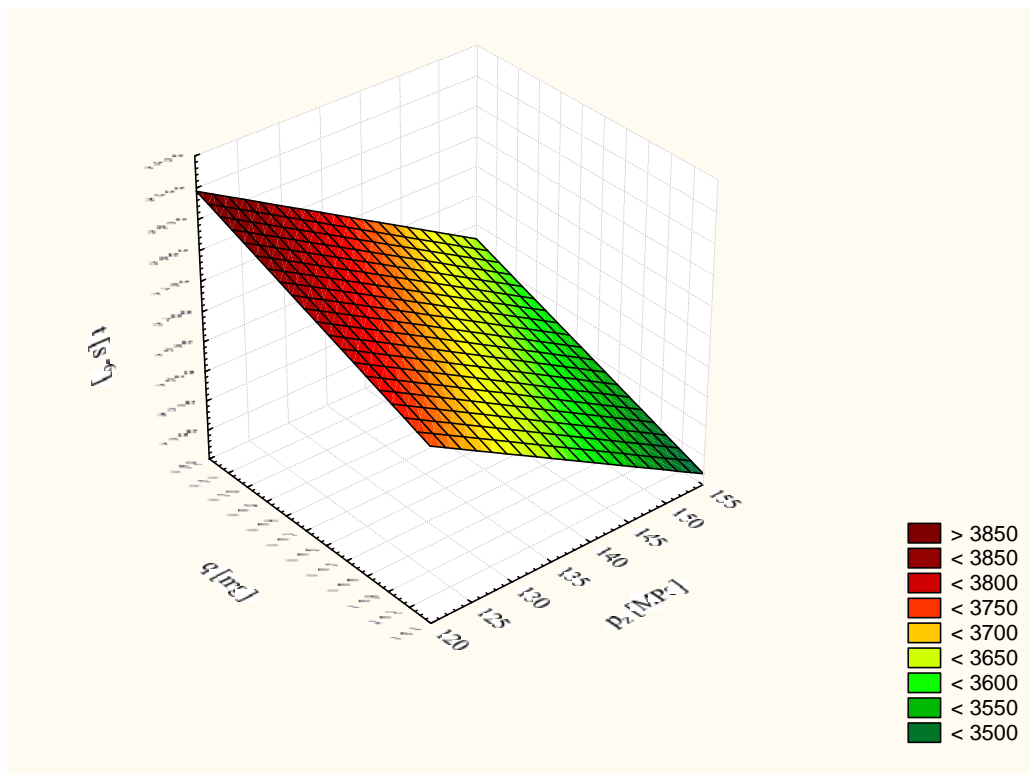

Fig. 14 Dependence of the nominal fuel dose q on the pressure in the hydraulic tank p_z and the total time of injection t for the three-piece fuel dose

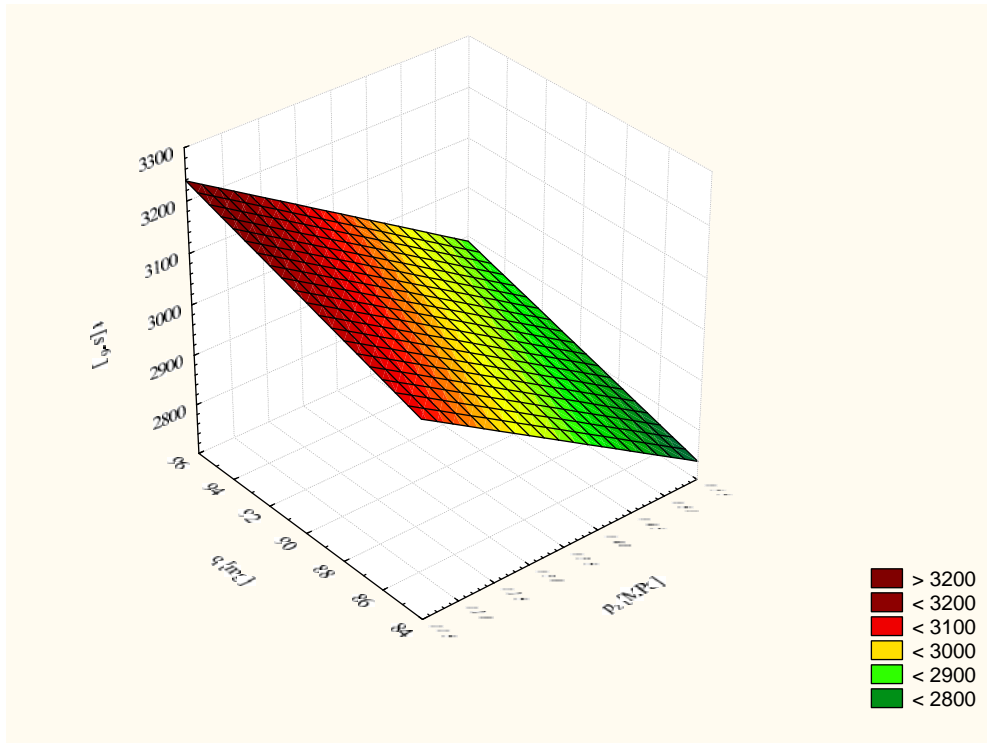

Fig. 15 Dependence of the average fuel dose q on the pressure in the hydraulic tank p_z and the total time of injection t for three-piece fuel dose

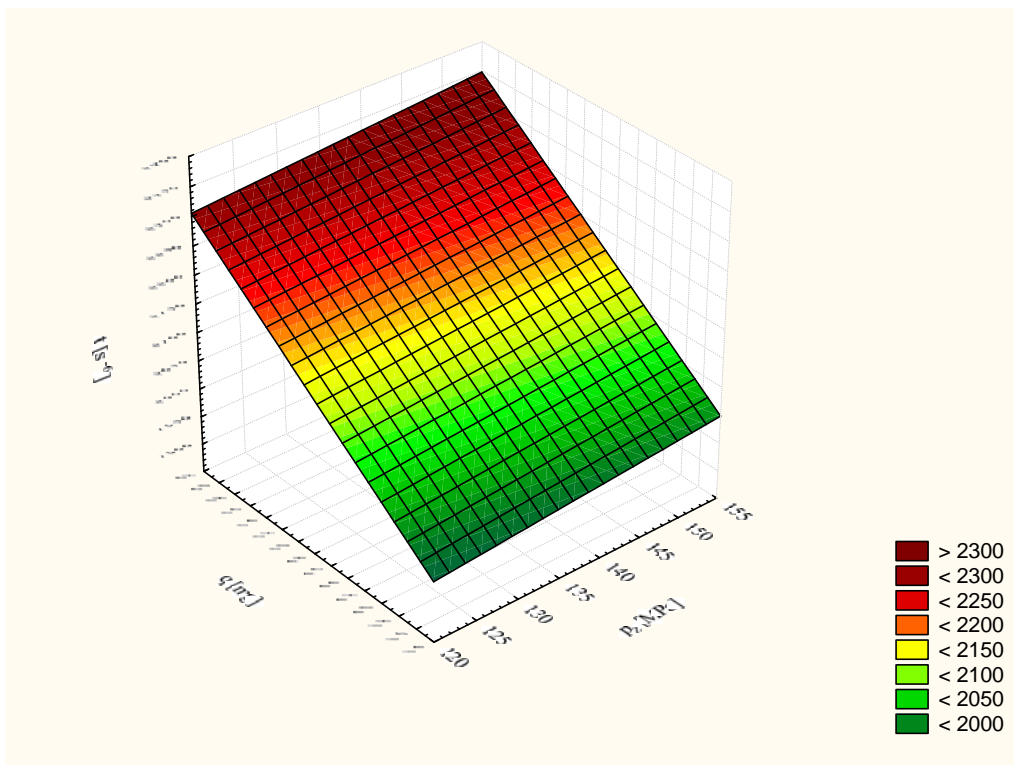

Fig. 16 Graph of dependence of the minimum fuel dose q on the pressure in the hydraulic tank p_z and the total time of injection t for three-piece fuel dose

Figures 17 ÷ 19 shows graphs of sequential basic parameters necessary to ensure the stable operation of the engine at minimum, medium and nominal engine speed. Posted graphs present in a comp manner the relationship of considered parameters.

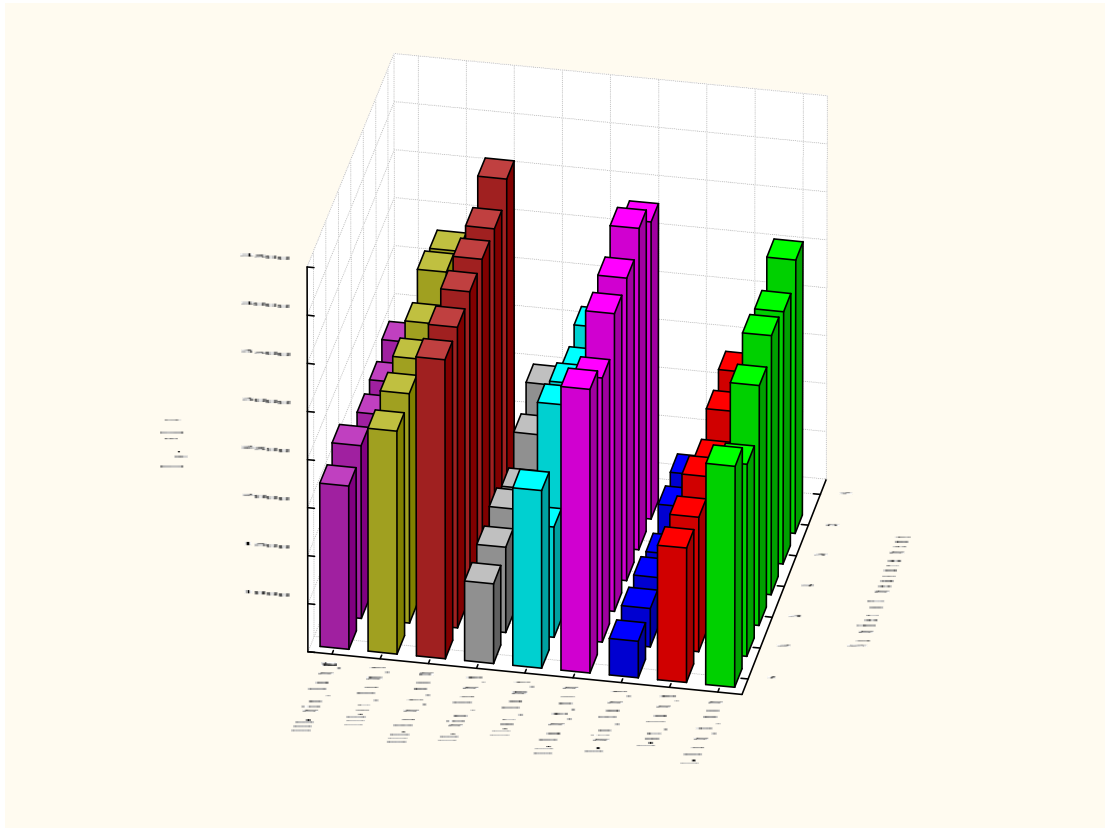

Fig. 17 Dependence of multiplicity of fuel dose on the time required for the completion of comparable fuel doses and assumed for research engine speed at different values of pressures in the hydraulic tank p_z (measurement 1,2 – the highest pressure, 3,4 – average pressure, 5,6 – the lowest pressure)

Fig. 17 contains the sequence graph of the total time required to complete the fuel delivery at a nominal dose, medium and minimum speed (eg II-Sum_t_nom – the total time of fuel injection for the two-piece nominal dose, I, II, III – multiplicity of the distribution of fuel dose), adequately one-, two- and three-piece for comparable doses of the three assumed to the research values of pressures in the hydraulic tank. As it can be remarked the time required to carry out the necessary fuel delivery depends both on the pressure in the hydraulic tank and the dosage multiplicity.

Fig. 18 shows the range of volumes of fuel doses for the considered variants of fuel injection (e.g. III-q_min - three-piece fuel dose at minimum engine speed).

Fig. 19 shows the value of pressure in the hydraulic tank for the considered variants of fuel injection (e.g. I-pz_sr - pressure in the hydraulic tank for a single fuel dose and medium engine speed).

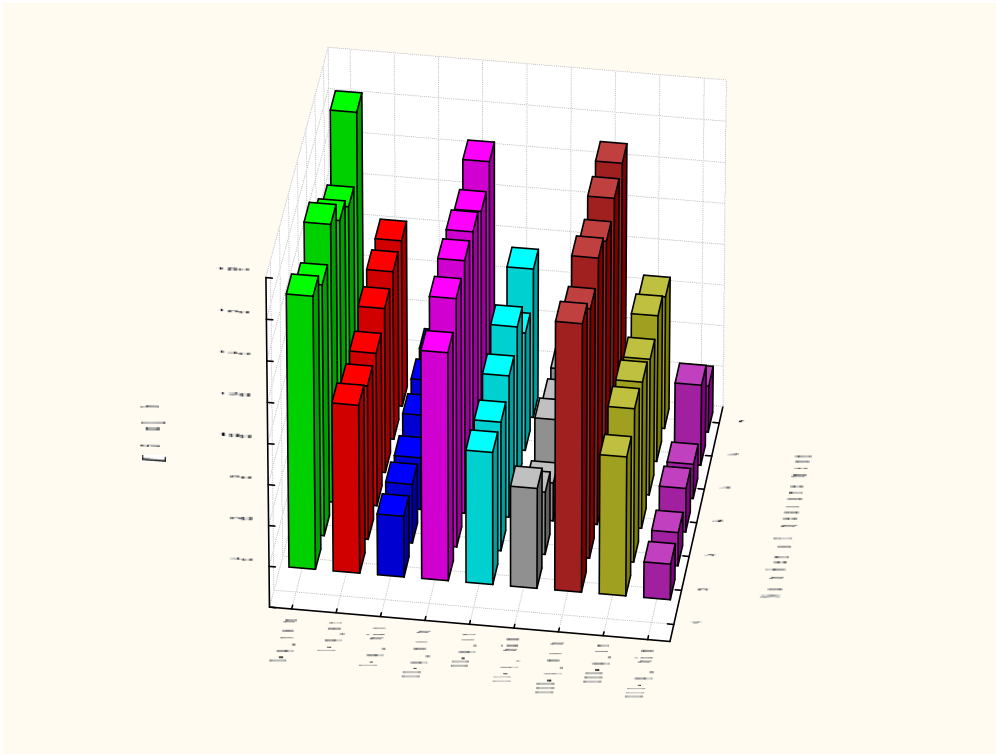

Fig. 18 Diversity of fuel delivery q for the considered multiplicity, engine speed (nominal, medium and minimum), and injection at different values of pressure p_z (measurement 1,2 – the highest pressure, 3,4 – average pressure, 5,6 – the lowest pressure)

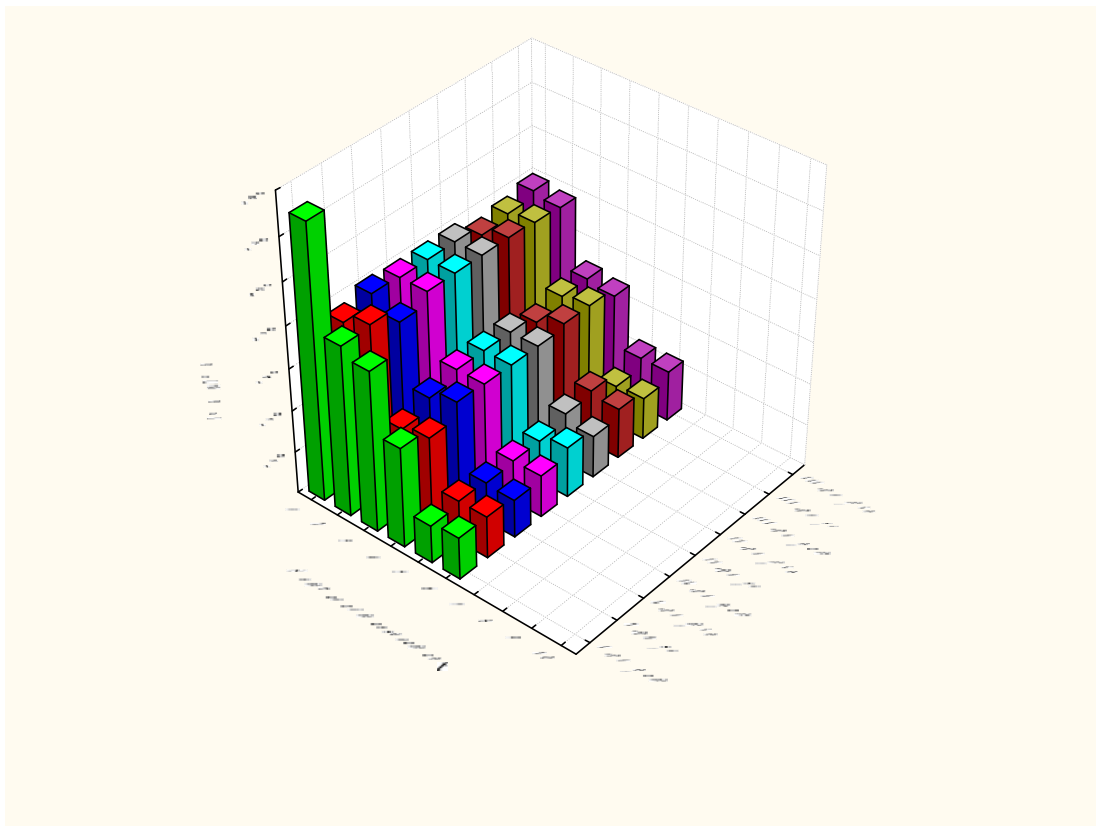

Fig.19. Values of pressure in the hydraulic tank p_z for the considered multiplicity of injection and nominal engine speed, average and minimum (measurement 1,2 – the highest pressure, 3,4 – average pressure, 5,6 – the lowest pressure)

5. Summary

Analyzing the obtained results it can be concluded that:

- for the analyzed nominal engine speed for which falls the shortest time to completion the full fuel dose the essential parameter that can be used to select the dose considering its quality is the pressure in the hydraulic tank;
- in case of medium and minimum engine speed there is available the longer time to carry out the necessary dosage of the fuel at adequate CA, and consequently at the same injection ratio, it is possible to control the injection timing;
- the total time for the completion of comparable doses of fuel at the same pressure but different multiplicities of dose distribution was much different;
- selecting multiplicity of the dose at specified pressure in the hydraulic tank it is possible to change the angle of the beginning and end of the fuel injection in dependence to engine load;
- the considerable dispersion of fuel doses: nominal, average and minimum is the result of complex wave phenomena, hydraulic impacts, turbulence, cavitation, etc., which are caused by rapid (about ms) overdrives in control valves, fuel injectors and hydraulic tank.

6. References / Literatura

- [1] Sobieszcański M.: Modelowanie procesów zasilania w silnikach spalinowych. Zagadnienia wybrane. WKŁ, Warszawa 2000.
- [2] Merkiś J.: Kierunki rozwoju spalinowych zespołów napędowych. Czasopismo Techniczne, Zeszyt 6-M/2004, str. 9 – 32.
- [3] Balawender K., Kuszewski H., Lejda K., Ustrzycki A.: Wpływ wielofazowości wtrysku na wybrane parametry systemu zasilania Common rail. Combustion Engines, 2008, No. 4, p. 22 – 28.
- [4] Kuszewski H., Lejda K., Ustrzycki A.: Determinanty dokładności dawkowania paliwa w systemie zasobnikowego układu zasilania Common Rail. Czasopismo Techniczne, Zeszyt 8 – M/2008, str. 161 – 172.
- [5] Informator Bosch: Zasobnikowe układy wtryskowe Common Rail. WKiŁ, Warszawa 2009.
- [6] Janiszewski T., Mavrantzas S.: Elektroniczne układy wtryskowe silników wysokoprężnych. WKiŁ, Warszawa 2009.
- [8] Zbierski K.: Układy wtryskowe Common Rail. Oficyna Wydawnicza, Łódź 2001. Krupa A.: Silniki sterowane elektronicznie – zaawansowane wdrożenia. Combustion Engines, 2004, No. 1, p. 20 – 27.
- [9] Bocheński C.: Możliwość sterowania procesami termodynamicznymi w silnikach wysokoprężnych przy zastosowaniu akumulatorowego (Common Rail) systemu paliwa. Journal of KONES Internal Combustion Engines, 2000, str. 38 – 44.
- [10] Kafar I., Merkiś J., Piaseczny L.: Model rozpylania paliwa w średnioobrotowym silniku okrętowym i jego badania symulacyjne. Combustion Engines, 2006, No. 3, pp.63 – 76.
- [11] Smolarz J., Walkowski M.: The model of steady fuel flow in the injector channels in the Common Rail systems. Scientific Journals. Maritime University of Szczecin. 2009, 17(89) pp. 80 – 86.