

**TRIBOLOGICAL MODEL OF POROUS BEARINGS
WITH PARTICULAR ATTENTION GIVEN TO THE
LUBRICANT LUBRICITY**

**MODEL TRIBOLOGICZNY ŁOŻYSK POROWATYCH
ZE SZCZEGÓLNYM UWZGLĘDNIENIEM
SMAROWNOŚCI SUBSTANCJI SMARUJĄCEJ**

Piotr Bzura

Gdansk University of Technology
e:mail: pbzura@pg.gda.pl

Abstract: *The friction and wear problems, accompanying all the tribological systems, lead to reduced service life. In order to prevent such situation, it is necessary to maintain fluid friction, which improves durability of all friction nodes in a tribological system. In the paper, the tribological system consists of porous bearings and the model deals with their weakest spots - the oil outflow points in the porous wall. A kinetic model of porous bearings is presented with particular attention given to lubricity of the lubricant, with the following objectives:*

- to determine the lubricity (i.e. the load-carrying capacity of boundary layer) of the lubricant,*
- to estimate the loads the porous bearing is subjected to, taking into account variation of the loads in time,*
- to determine the effect of lubricant lubricity on the porous bearing service life.*

Keywords: *cohesion forces, coefficient of kinetic friction*

Streszczenie: *Problemy tarcia i zużycia, towarzyszące wszystkim układom tribologicznym doprowadzają do zmniejszenia trwałości. Aby temu zapobiec konieczne jest utrzymanie tarcia płynnego w wyniku, czego następuje podwyższenie trwałości wszystkich węzłów tarcia układu tribologicznego. W pracy jako układ tribologiczny rozpatrywane są łożyska porowate, a model dotyczy ich najslabszych ogniw, którymi są miejsca wypływu oleju ze ścianki porów. Przedstawiony został kinetyczny model łożysk porowatych ze szczególnym uwzględnieniem smarowności substancji smarującej w celu:*

- wyznaczenia smarowności (tzn. wytrzymałości warstwy granicznej) substancji smarującej*
- oceny obciążeń, którym łożysko porowate jest poddawane, przy uwzględnieniu zmian tych obciążeń w czasie*
- wyznaczenia wpływu smarowności substancji smarującej na trwałość łożysk porowatych.*

Słowa kluczowe: *siły spójności, współczynnik tarcia kinetycznego*

1. Basic factors of the reliability theory of porous slide bearings

Let's assume that a combustion engine with porous slide bearings of average physical-chemical properties is started. Let's also assume that the bearings are loaded slightly below the actual structural strength of the porous bearing shell.

From the probabilistic point of view [5,6], a probability P_O is introduced that the load has a certain value P or is greater than P and a corresponding probability P_w that the bearing shell structural strength has a certain value P .

However, it has to be remembered that the engine, after starting, has a number of equally loaded porous slide bearings. Experiments indicate [8,9] that because of e.g. different distribution of pores in the bearing shells, they have different structural strength. As an effect of those variations, a certain inhomogeneity of their strength may be expected. With a large number of bearings, the average bearing shell strength will take a value of P_2 and the strength distribution diagram will have the form shown in Fig.1.

Let's assume further that the porous bearings are installed on the engine crankshaft and in consequence each bearing is subjected to individual load. There will be small differences and the average load will take a value of P_1 and the load distribution diagram will have the form shown in Fig.1, which also has an impact on the number of damaged porous bearings.

The last factor that must be taken into account is the time influence. In the case of porous slide bearings, cumulative effects of operation in the bearing shell macro- and microenvironment may cause the lubricant effluent, which may lead even to seizure of the bearing. Besides, the load varies in time, e.g. due to increased crankshaft vibrations. These factors can be presented in the form of a distribution, where the (τ) designation indicates that the distribution and number of defects change in time.

All these porous slide bearing reliability influencing factors [3,4,5,6] are presented in the form of a graph in Fig.1.

The above considerations indicate the basic factors which must be taken into account in formulating the reliability theory for practical use of the porous bearings. Those factors must lead to finding:

- a method of determining the strength of the porous bearing weakest element,
- estimation methods of the changes of weakest element strength for a given number of porous bearings,
- a method of estimating the loads the bearing is subjected to, taking into account the load changes in time,
- methods of determining the impact of the weakest element strength and the bearing loads on the bearing service life.

As the porous slide bearing is a complex tribological system, it may be compared to a "chain". When it is subjected to a slowly increasing load, the break will occur in the weakest element.

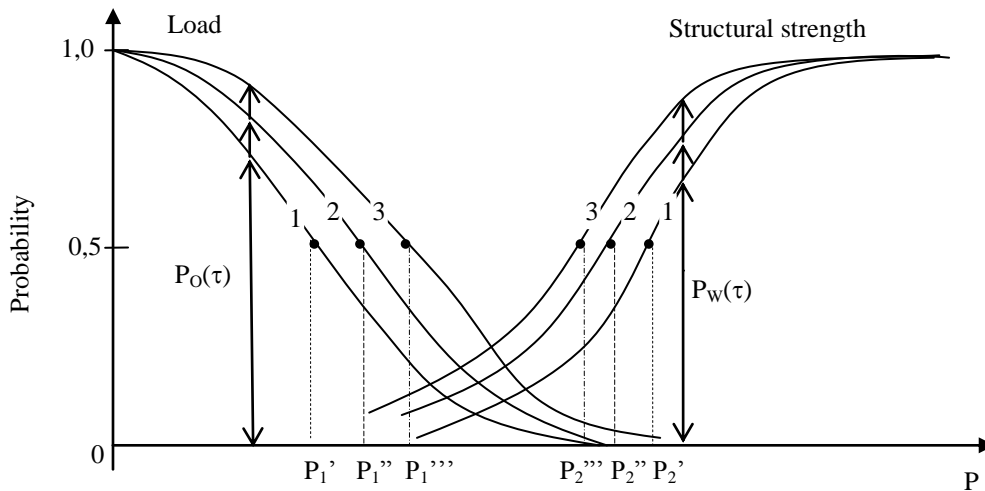

Fig.1 Illustration of the changes of load distributions and porous bearing shell structural strength in time

where:

- probabilities $P_O(\tau)$ that load is smaller than or equal to P (if the average load is equal to P'_1),
- probabilities $P_W(\tau)$ that the porous bearing shell structural strength is greater than P (if the average strength is equal to P'_2),
- the $P_2' - P_1'$ distance is the bearing shell structure margin of safety in relation to the load after τ_1 time,
- the $P_2'' - P_1''$ distance is the bearing shell structure margin of safety in relation to the load after $\tau_2 > \tau_1$ time,
- the $P_2''' - P_1'''$ distance is the bearing shell structure margin of safety in relation to the load after $\tau_3 > \tau_2$ time.

The Pierce's remark made in 1926 comes back: "It is a truism leading to a not trivial mathematical conclusion that the chain strength is the strength of its weakest link".

2. Strength, load and damage in the porous bearing weakest element

The porous bearings [2,8,9] (Fig.2.) are manufactured by compaction and sintering of the iron or bronze powders. They have in their structure a network of interconnected pores. After saturating with oil and mounting, they form a bearing and a lubricating system in one. The bearing shell self-lubrication conditions limit considerably the area of safest friction type - the fluid friction. Therefore, they usually operate in the mixed friction conditions, which evidently has a negative impact on their service life. The present day porous bearingshells have the oil so selected and the element wear boundary curves so determined that if the mixed friction occurs then the fluid friction makes a considerable contribution to it.

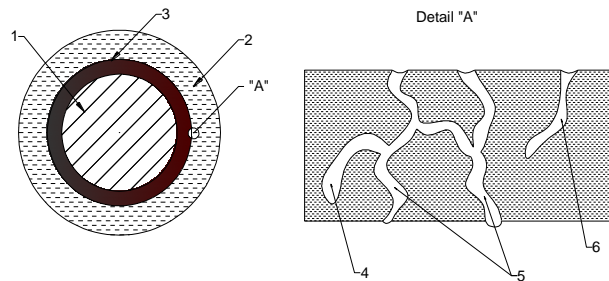

Fig.2 Diagram of the porous slide bearings: 1 - pin, 2 - porous bearing shell, 3 - lubricant in the bearing shell material, 4 - dead-end branch, 5 - open through pores, 6 - one-sidedly open pore

The weakest link of a porous bearing in operation is the point of oil effluence from the porous bearing shell. A boundary layer must be necessarily maintained in these points to avoid excess wear. Durability of the boundary layer (i.e. quality of connection of the lubricating oil with the pore surface) depends on the surface energy in the weakest link. Total surface energy E_s :

$$E_s = E_m + E_w + E_p \quad (1)$$

where:

- E_s – total solid body macro- and microstate energy,
- E_m – macrostate energy (kinetic and potential energy of the body as a whole),
- E_w – body internal energy (kinetic energy of the crystal lattice vibration, potential energy of crystal lattice deformation, kinetic energy of electrons, all forms of binding energy),
- E_p – potential energy.

The total surface energy comes from unsaturation of the intermolecular forces on the interphase boundary of the solid body and lubricating oil.

It is practically impossible to determine the link surface energy, therefore the greasy lubricant is accepted as a simple real object of the weakest link. The greasy lubricant is a liquid with colloidal structure composed of a thickener and base oil. It is not a Newtonian fluid and does not flow in normal conditions under the gravitation effect. The lubricant has a space structure (Fig.3). The structure lattice gives thixotropic and in a sense also plastic properties. Therefore, a small pressure does not cause displacement of one lubricant layer in relation to another, i.e. flow does not occur and the internal friction is practically not determined.

In the perfect objects accumulation of energy occurs under the effect of load, i.e. transmission of energy from its source to the accumulation point in the object [6, 12]. The greasy lubricant, as a real object, should be considered an object with local deviations from perfection. With such local deviation, the greasy lubricant may be treated as a set of smaller "links". Most of these small "links" are identical and have the same standard characteristics. The other links have "non-standard" characteristics and points where elementary defects occur are not identical.

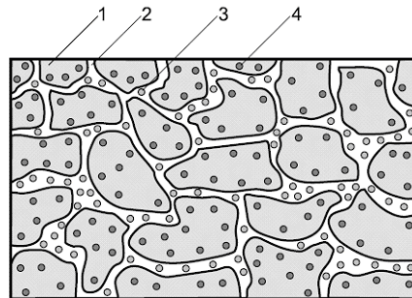

Fig. 3 Greasy lubricant structure diagram: 1 – base oil, 2 – thickener, 3 – additives in the thickener composition, 4 – additives in the oil composition

Some of them will be damaged at lower (below standard) values of the accumulated energy. These are the "weakest links" where the energy equation has the form:

$$\text{input energy} = \text{accumulated energy} + \text{lost energy} \quad (2)$$

In equation (2) the relation between the total input energy and total accumulated energy is linear (the energy conservation law). As long as the cohesion forces keep the oil, the object will absorb energy without limitation. The critical point where energy ceases to be accumulated and decohesion occurs may be identified with the object strength. Then the solution of energy equation (2) takes the following form:

$$\text{accumulated energy} = \text{lost energy} \quad (3)$$

The above presented reasoning leads to the following definition and postulate [5]:

- damage point in a perfect link is the point where a given energy accumulation law becomes invalid,
- damage in a certain point of perfect link occurs when energy accumulated by that mechanism exceeds a certain critical value.

The postulate says that if all the forms of energy accumulated in the weakest perfect link remain within their critical boundaries then the lubricating oil boundary layer in the object will not be broken.

The paper presents a possibility of using the greasy lubricant structure, which, by the presented similarity criteria [2], reflects the porous bearing shell structure, as the porous bearing weakest link.

3. Effect of cohesion forces on kinetic friction

All the solid bodies (e.g. porous bearing shells) and liquids (e.g. lubricating oil, greasy lubricant) consist of a great number of atoms or particles connected by bonds of various types [7].

The porous bearing shells are sleeves with pores forming capillary ducts. The bearing weakest link is the point where lubricating oil flows out of the pore ducts. At that point (Fig. 4), in the pore surface force field, the lubricating liquid particles decrease their mobility. A separate phase of the liquid, ordered and packed in a

volumetric unit, with increased viscosity and density is created in the pore surface zone. The impact of the pore surface force field is the strongest close to the surface and it decreases rapidly with increasing distance. Therefore, the cohesion forces are the greatest for the oil particles adjacent to the lubricated surface (i.e. the bearing shell pore edges) where the layer thickness does not exceed $0.5 \mu\text{m}$.

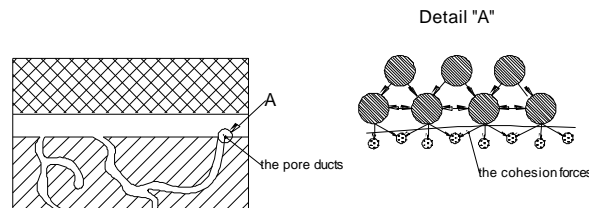

Fig.4 Boundary layer cohesion forces at the point of oil effluent from the ducts

Fig.5 presents distribution of forces in the greasy lubricants. The cohesion forces are specific interactions called Van der Waals forces [7]. They may be divided into four basic groups: dispersion forces (London forces), confirmation forces, orientation forces (Keesom forces) and induction forces (Debye forces). However, they cannot effect a greater liquid area due to considerable distances between atoms and also they cannot last long.

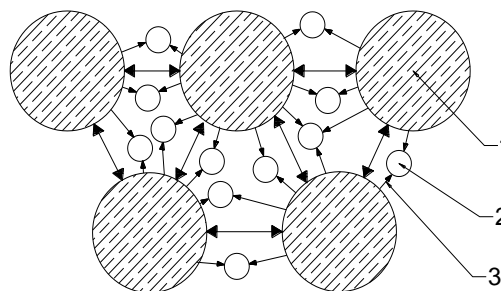

Fig.5 Diagram of the greasy lubricant structure:
1 - thickener, 2 - base oil, 3 - cohesion forces

The parameter defining proper operation of a porous slide bearing is its carrying capacity, i.e. such load when breaking of the boundary layer will not occur yet in the weakest link. The input energy (2) will be absorbed without limitation and the cohesion forces will not be interrupted. The limit value of that energy may be associated with lubricity. The lubricant lubricity is the ability of oil to adhere stably to the surface of solid bodies or to thickeners in greasy lubricants due to the molecular attraction. Thin boundary layers are then created with lubricating properties not connected with viscosity. The moment of cohesion force interruption, i.e. passing from boundary friction to mixed friction (3) may be determined from the kinetic model of tribological system seizing.

Kinetic model of the tribological system seizing

The combination of phenomena taking place in the mutually shifting matching contact areas is called friction. It is estimated that $\frac{1}{2} \div \frac{1}{4}$ of the total energy generated worldwide is used up for overcoming the friction resistance.

Friction resistance is defined by the value of the coefficient of friction. Friction occurs in standstill as well as in motion of contacting bodies. According to the Coulomb theorems of 1781, there are two definitely separate kinds of friction - the static friction counteracting displacement of a body and the kinetic friction representing the motion counteracting force.

In the porous bearing shells, passing from fluid friction to seizure caused e.g. by increased pressures, slide speed or temperature, takes place in several stages: fluid friction (I) \Rightarrow boundary friction (II) \Rightarrow mixed friction (III) \Rightarrow seizing (IV) \Rightarrow seizure (V). It is accompanied in the pore ducts by increased resistance to motion and intensity of wear and tear, which can be identified by analysis of the coefficient of kinetic friction. Fig. 6. shows graphical presentation of the kinetic model of tribological system seizure [9].

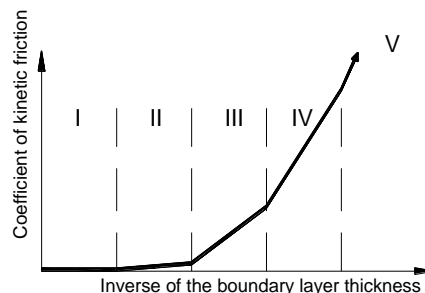

Fig. 6 Stages of passing of the porous bearing shell weakest link (oil effluent from ducts) from the fluid friction to seizure

Stage I does not cause the wear and tear. During stage II the elastic and plastic strain as well as the tribochemical wear occur. In stage III the adhesive wear takes place. Stage IV is the phase of adhesive seizing (destruction of the solid body boundary layer to a considerable depth), leading to stage V - seizure.

The presented model allows to investigate the boundary friction resistance at different normal pressures, different rotational speeds and different temperatures, i.e. passing from stage II to stage III. It can be seen from the works of Amontons, Achmatov and Bowden [7] that the value of the coefficient of kinetic friction depends also on the type of contacting materials and on the lubricating substance.

4. Experimental investigations

For determination of the cohesion force breaking moment, a kinematic model of zero wear of balls in the T-02 four-ball tester (Fig. 7) is used. The friction contact in that machine consists of four 12.7 mm diameter balls made from the 62.7 HRC

hardness bearing steel. Three balls are placed in the cup-shaped lower holder-container, where the investigated lubricating substance is poured to $(8 \pm 2 \text{ cm}^3)$. The fourth ball is fixed in the upper holder. It rotates during the investigation with the speed from 20 rpm to about $2000 \pm 50 \text{ rpm}$.

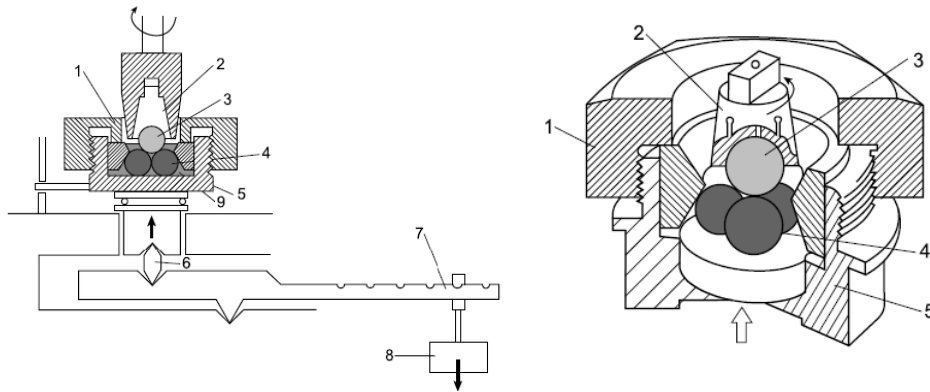

Fig. 7 Kinetic scheme of the four-sphere apparatus: 1) cover which fixes the lower spheres, 2) holder of upper sphere, 3) upper sphere (rotating), 4) lower spheres (stationary), 5) container with the tested lubricant, 6) prism, 7) lever, 8) weights, 9) tested greasy lubricant [10]

The experimental investigations were carried out with:

- graphite grease on the mineral oil base, containing at least 10% of lime-thickened natural graphite, used for lubricating heavily loaded friction nodes in the -20 to $+50^\circ\text{C}$ temperature range,
- the LT43 grease on the lithium-thickened mineral oil base. It contains improvers, in particular antioxidant, anticorrosive and lubricating properties improving additives, used for lubricating heavily loaded friction nodes in the -20 to $+130^\circ\text{C}$ temperature range,
- the Lotos "CITY" mineral oil.

All the lubricant investigations were carried out for 25°C temperature and 50 rpm rotational speed (zero wear of the T-02 tester balls).

The diagram presents changes of the coefficient of kinetic friction caused by gradual increase of the normal pressure. Just after the start the inertia resistance occurs, which turns into friction resistance dependent on the coefficient of friction. Then the first indications of wear can be observed (minimum diameter of the ball wear appears, greater than the elastic strain). Using the so called seizing delay (τ_1 , τ_2 , τ_3), introduced by Blok [1], the pressure when the boundary layer is broken can be determined for each lubricant.

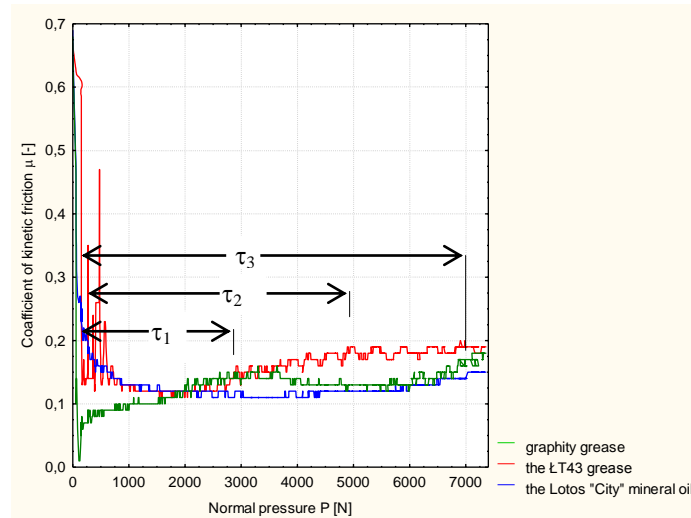

Fig. 8 Dispersion diagram for the 50 rpm spindle rotational speed at 25 °C temperature

5. Final remarks and conclusions

The moment of the porous slide bearing first damage may be determined by continuous control of the weakest link. That link are the points of oil outflow from ducts in the pores. Therefore, the measurement is to determine the moment of break of the boundary layer, or the cohesion forces from the effect of the pore field of surface forces.

The presented model of tribological system kinetic friction allows to determine the critical durability limits of the porous bearing shell weakest link. The critical durability limit (i.e. the smallest load under which the oil boundary layer is broken) is important for greasy lubricants as their cohesion force is smaller compared with cohesion forces of the lubricating oil separate phase created in the pore duct wall zone. This implies existence of a certain value of load which may be applied to a porous bearing for an unlimited period of time. In fact, with the passage of time all the porous bearings will be weakened.

In order to use the method in practice, the four-ball tester balls must be made from the material of similar structure to that of the bearing shell structure and comparison must be carried out of the seizing delay measurement results (for a specific temperature, pressure and slide speed) for:

- porous bearing lubricating oil,
- greasy lubricant;
- base oil of that greasy lubricant.

The seizing delay τ will probably be the longest for the porous bearing lubricating oil and the shortest for the greasy lubricant. Then the critical limit of durability can be determined.

The above considerations indicate clearly a significant impact that the lubricity has on the durability of porous slide bearings.

6. References, literatura

- [1] Blok H.: Seizure – Delay Method for determining the Seizure Prediction of EP – Lubricants. SAE Trans.1939 vol.44 pp.193-198
- [2] Bzura P.: A method for evaluating durability of porous slide bearings. Polish Maritime Research No 1(68) 2011 Vol 18
- [3] Czajgucki Z.,J.: Niezawodność spalinowych siłowni okrętowych. Wydawnictwo Morskie. Gdańsk 1984
- [4] Gercbach I.B., Kordonki CH.B.: Modele niezawodnościowe obiektów technicznych. Wydawnictwo Naukowo-Techniczne, Warszawa 1968
- [5] Haviland R.P.: Niezawodność urządzeń technicznych. Państwowe Wydawnictwo Naukowe, Warszawa 1968
- [6] Hebda, M., Wachal, A, Trybologia, WNT, Warszawa 1980
- [7] Lawrowski Z.: Technika smarowania, Wydawnictwo Naukowe PWN Warsaw 1996.
- [8] Lawrowski Z.: Bezobsługowe łożyska ślizgowe, Wydawnictwo Politechniki Wrocławskiej, Wrocław 2001.
- [9] Nosal S.: Tribologiczne aspekty zacierania się węzłów ślizgowych. Wydawnictwo Politechniki Poznańskiej. Poznań 1998
- [10] Szczerek M., Tuszyński W.: Tribological tests. Seizing. Radom: Biblioteka Problemów Eksploatacyjnych 2000



Mr. Piotr Bzura PhD – Assistant Prof in the Faculty of Ocean Engineering and Ship Technology Gdansk University of Technology