

Paweł STEŻYCKI ORCID 0000-0002-8151-3611

Łukasiewicz Research Network – Institute of Aviation (Sieć Badawcza Łukasiewicz – Instytut Lotnictwa)

APPLICATION OF LIQUID HYDROGEN AS A FUEL FOR FUTURE PASSENGER AIRCRAFT

Zastosowanie płynnego wodoru jako paliwa do samolotów pasażerskich

Abstract: *The paper briefly reviews a recent initiative on the application of hydrogen as a fuel for future commercial aircraft. Special attention is paid to the benefits of using liquid hydrogen (LH2) to power aircraft engines. A comparison of LH2 to other fuels is presented, as well as a comparison of LH2 hazard to hazard imposed by typical jet fuel. Major attention is focused on the combustion of hydrogen benefits in turbine engines with classic deflagrative combustion chamber and engines utilizing detonative combustion of the hydrogen-air mixture. Benefits and problems with the utilization of LH2 are discussed in this paper.*

Keywords: liquid hydrogen (LH2), commercial aviation, combustion, detonative engines, hydrogen embrittlement.

Streszczenie: *W artykule dokonano przeglądu niedawnej inicjatywy dotyczącej zastosowania wodoru jako paliwa do przyszłych statków komercyjnych. Szczególną uwagę zwrócono na korzyści z zastosowania ciekłego wodoru (LH2) do zasilania silników lotniczych. Porównano LH2 z innymi paliwami oraz przedstawiono zagrożenia z zastosowania LH2 z zagrożeniami stosowania tradycyjnego silnika odrzutowego. Ponadto, skupiono się również na spalaniu wodoru w silnikach turbinowych z klasyczną deflagracyjną komorą spalania oraz silnikach z detonacyjną komorą spalania mieszanki wodorowo-powietrznej. W artykule omówiono także zalety i problem związane z wykorzystaniem LH2.*

Słowa kluczowe: płynny wodór (LH2), lotnictwo komercyjne, spalanie, silniki detonacyjne, kruchość wodorowa.

1. Introduction

The first analyses of possible applications of LH2 to commercial aircrafts propulsion were already considered in the USA in the seventies of the last century [3, 7, 42]. At that time, such analyses were motivated mainly by the possible energetic benefits of introducing LH2 as a fuel for commercial transport. However, the analyses show that at that time, only energetic benefits could have been achieved from the applications of LH2 to supersonic transport, but for the subsonic aircraft, no significant energetic benefits, but many problems related to its utilization were found. Moreover, at that time, detailed analyses of the issues associated with handling LH2 compared to jet fuel were conducted. As a conclusion from the overall analysis of benefits and problems of applying LH2, such an idea abounded for nearly half of the century. Recently, the idea of using LH2 fuel for commercial aviation was reintroduced due to the possibility of eliminating CO2 emissions and the search for alternative aviation fuels. For these reasons, the development of hydrogen-powered aircraft became a topic of significant interest. The AIRBUS announcement of initiating the development of aircraft powered by LH2 fuel also initiated a quest to convert recently used aircraft engines to be propelled by hydrogen fuel (Fig. 1) [4, 15, 23]. The implementation of LH2 in commercial aviation creates many problems which should be solved, such as large-scale production, distribution and storage of LH2 in both- airports and aircraft [4, 10, 30, 33]. Additionally, modification of the existing turbofan engines for the deflagrative burning of hydrogen or the development of new, more efficient methods of detonative burning of hydrogen in jet engines' combustion chambers is required [28, 39, 44–46]. The simplest solution would be to redesign classic combustion chamber to use hydrogen combustion in a deflagrative mode. This could enable to organize combustion process in such a way that in the main chamber lean mixture is burned, so it will not be necessary to mix combustion products with extra air to meet the requirements of combustion products' temperature – not to exceed the temperature limit for products entering the first stage of high-pressure turbine. Furthermore, due to the relatively long occupation time of products in the combustion chamber, special attention needs to be paid to lower NOx formation. Additionally, pressure will drop during such combustion. In contrast to deflagrative combustion, applying the continuously rotating detonation (CRD) to combustion chambers of such engines offers many benefits, such as a very short combustion chamber and pressure increase during detonation. A very short combustion chamber will also result in a short occupation time of detonation products in high-temperature regions, so less NOx will be generated in connection to the detonation of the lean hydrogen-air mixture. Additionally, pressure will be increased during detonation, so some compressor and turbine stages can be removed from the engine, making the engine shorter, lighter and less expensive. It is most important that an engine utilizing CRD of hydrogen fuel will be more efficient. It was already proved that the gas turbine engine GTD-350, tested in the Polish Institute of Aviation and operating on gaseous hydrogen fuel and utilizing CRD, exhibited a 5-7% improvement in efficiency [39, 46]. So in this paper, special attention will be paid to problems related to deflagrative, and detonative combustion of the gaseous hydrogen-air

mixtures in modified combustion chambers of the future engines used to power hydrogen-fueled commercial aircraft.



Fig. 1. Artist's impression of hydrogen-powered commercial aircraft envisioned by AIRBUS. On the left is a plane with two hydrogen turbofan engines providing thrust. The liquid hydrogen storage and distribution system are located behind the rear pressure bulkhead. On the right is a Blended-Wing Body aircraft with much optional storage of LH₂ and powered by hybrid-hydrogen turbofan engines.

[<https://www.airbus.com/en/innovation/zero-emission/hydrogen/zeroe>]

2. Liquid hydrogen (LH₂)

Hydrogen is the most abundant element in the Universe and thus in the Earth, but on our planet, it mostly exists in molecular forms such as water and organic compounds. It can be obtained by different ways of production. The simplest method is the electrolysis of water, but recently it has been the most expensive one. (only about 4% of hydrogen is obtained this way). The most popular and less expensive way of hydrogen production is by pyrolysis of methane (about 48% of the world's production). Hydrogen can also be produced from crude oil or coal. Considering future hydrogen production by electrolyze with the utilization of green energy for such a process, we could have an unlimited hydrogen source. The biggest problem is the price since the cost of the hydrogen produced using electrolyze of water is recently about 6 times higher than the one obtained by pyrolysis of methane. It should also be mentioned about the additional investment needed, the cost of ground storage and transportation, as well as special tanks for storage of hydrogen (compressed gaseous for small and cryogenic liquid for large aircraft). A comparison of hydrogen to other energy sources is presented in Fig. 2. It is well known that the combustion energy of hydrogen per its mass (gravimetric energy density) is much higher than any other fuel. Still, if this energy is related to the volume (volumetric energy density), many other fuels are more energetic. The volumetric energy density of liquid hydrogen is about 3.7 times lower than Jet-A, about 2.5 lower than liquid methane and about 2.8 times than methanol.

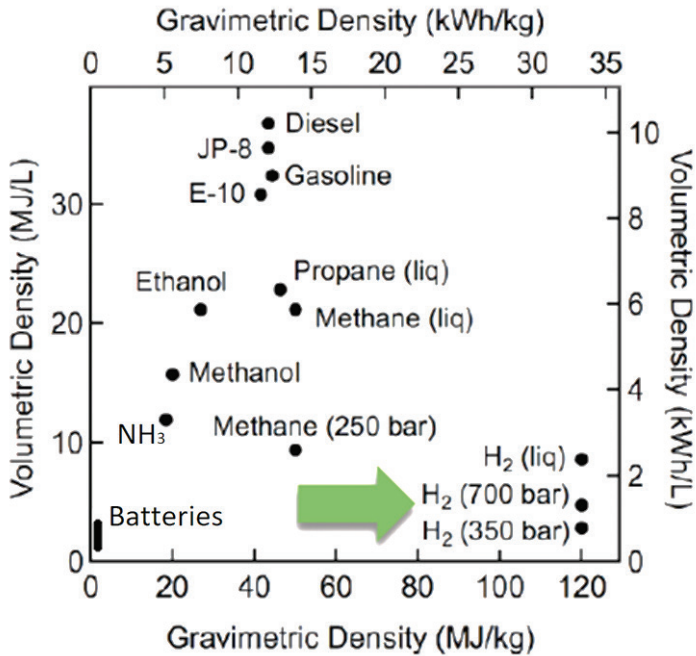

Fig. 2. Comparison of Gravimetric/Volumetric Energy density of different fuels including compressed and liquid hydrogen

Table 1

Comparison of possible aviation alternative fuels

Fuel/Parameter	Jet-A	Gasoline	Ethanol	Methane	Hydrogen
Chemical composition	H/C ~ 0,16	H/C ~ 0,18	C ₂ H ₅ OH H/C ~ 0,168	CH ₄ H/C ~ 0,33	H ₂
Molecular weight	~ 120	~ 145	46.06	16.04	2.016
Combustion Heat, MJ/kg	~ 42.8	~ 41.7	29.75	49.08	120
Density kg/m ³	~ 753	690-770	817	425	71
Boiling temp. [K]	470-560	308-509	352	112	20.5
Freezing temp. [K]	~ 220		158	90.8	14
Heat of vaporization [kJ/kg]	244-256	230-335	853.6	581.5	449
Specific heat [kJ/kg K]	2.01		2.59	3.44	9.29
Fuel density/Jet-A density	1		1.08	0.56	0.094
Heat of comb. / heat of comb. of Jet-A (per kg of fuel)	1		0.7	1.15	2.8

Fuel/Parameter	Jet-A	Gasoline	Ethanol	Methane	Hydrogen
Heat of comb. / heat of comb. of Jet-A (per m ³ of fuel)	1		0.75	0.65	0.25
Combustion limits with air [%]	1.5-7.9	(0.8-1.8)- (3.1-5.76)		5-15	4-75

To compare energy storage in the tank to the total mass of the fuel system, the so-called gravimetric index (GI) was introduced. It is a ratio of the fuel mass to the total mass of the fuel system. For today's jet fuel GI is close to 100%, but using today's technology of LH2 storage, the GI is only about 20%. However, there is an estimation that by the introduction of innovative, isolating and functional materials as well as by using aircraft fuselage as a tank structure, the GI index could be increased even up to 50%. We can also add a few factors related to increased engine's cycle efficiency related to higher work generated by steam in comparison to CO₂, e.g. a higher ratio of specific heats (cp/cv), the possibility of incoming air cooling before or in the engine compressor by LH2 (so lower work of compressor and possible less turbine stages is required) and if detonation combustion is introduced in engine's combustion chamber, pressure will not drop, but an increase may be expected. So as was mentioned, the LH2 can be used to cool air entering the compressor; thus, compression work will be lowered, less turbine stages will be needed to drive the compressor and only for this reason, engine's efficiency will be increased. If it is burned in a detonative combustion chamber in which pressure increases in the detonation wave, the engine's efficiency will be further improved. Additionally, if LH2 is used in supersonic/hypersonic transport, it could also be used to cool the aircraft's structure during supersonic/hypersonic flight in the atmosphere.

But using LH2 as the fuel may be associated with some additional hazards. A comparison of possible hazards of LH2 in comparison to the classical hydrocarbon aviation fuel is presented in Table 2.

Additionally, since LH2 is stored at a temperature of about 20K, it will slowly evaporate even if a very good isolation system is applied. If the evaporation is relatively low, gaseous hydrogen can be vented into the surrounding air, but it can also be used to run the auxiliary power system on the aircraft. But for larger airplanes, special system should be installed to re-liquidize gaseous hydrogen.

Table 2

Comparison of the hazard created by LH2 and classical jet fuel

Associated hazard	Effect of different fuels		More safe
	Liquid hydrogen (LH2)	Jet fuel (A-1)	
Small leak	Liquid hydrogen is heavier than air, but evaporates very quickly	May form local splits and when mixed with air may create local	LH2

Associated hazard	Effect of different fuels		More safe
	and its vapors (gaseous H ₂) volatilize rapidly. No threat.	explosive concentration, also very low ignition energy.	
Explosion hazard	Large range of explosive concentration with air, very low ignition energy but low probability of creating explosive mixture due to high buoyancy (volatilization, lifting).	When split on ground can form local explosive concentrations, also easy to ignite.	LH2
Initiation of detonation	none	none	None
Effect on man	Small amount of LH ₂ in contact with the skin evaporate immediately without damaging the tissue. Large quantities cause severe burns. Hydrogen gaseous is colorless, odorless and non-toxic	Jet fuel causes slight irritation of the skin and its vapors are toxic at the level of 500 ppm.	LH2
Influence of temperature	LH ₂ boils at 20K. Increasing the temperature of LH ₂ requires ventilation or re-condensation of hydrogen vapors.	An increase in storage temperature causes only a slight increase in the volume of a Jet fuel.	A-1
Impurities	Due to the low boiling point, LH ₂ can only be contaminated with helium. The remaining mechanical impurities can be easily separated.	Jet fuel can be contaminated by both mechanical and organic factors, including water, the removal of which creates serious problems.	LH2

3. Engines with the deflagrative combustion chamber

To ensure effective combustion in an aircraft engine, LH₂ has to be evaporated. It is well known that gaseous hydrogen can burn with air mixture in a very wide concentration range, from 4 to 75% and detonate for a concentration range of 18 to 70% [32, 37]. A comparison of combustion properties/parameters of hydrogen to other fuels is presented in Table 3. As it was already mentioned, hydrogen in a mixture with air can burn in a very wide concentration range, and the combustion velocity of the hydrogen-air mixtures is the highest not only due to the high combustion energy but also due to the very high diffusion coefficient.

The laminar combustion velocity of the hydrogen-air mixture is 4-6 times higher than for hydrocarbon fuels-air mixtures [16]. In classical jet engines, combustion chambers fuel-air mixture is always burned in concentration close to stoichiometric ratio and in a highly turbulent flow. In modern jet engines' combustion chambers, combustion is organized in

the staged form to reduce NOx emission, so the occupation time in the high-temperature zone is reduced. Also, for typical hydrocarbon jet fuel, nitrogen oxides are produced by two different mechanisms; so-called fuel-related and Zeldovich mechanism [16]. Fuel-related mechanism of the NOx formation does not exist for LH2 since there are no traces of nitrogen in LH2. Additionally, in LH2, no other impurities will be present since, at the storage temperature of LH2, all other impurities (besides helium) are frozen and thus easy to eliminate during production and distribution. So combustion has to be organized in such a way as to minimize the production of NOx due to the Zeldovich mechanism. In the Zeldovich mechanism, NOx is related to two parameters: temperature and occupation time in the high-temperature zone where free oxygen and nitrogen are preset. Burning hydrogen in the lean mixture will lower temperatures than at the high-temperature region in the classical jet engine combustion chamber.

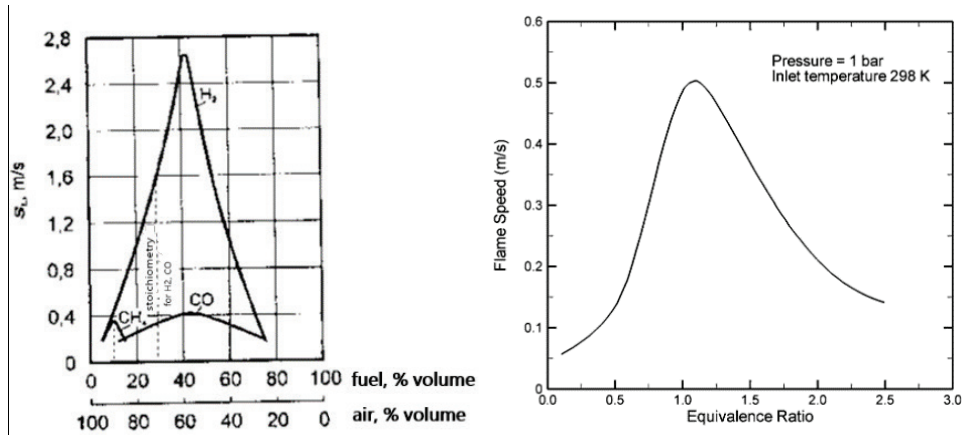

Fig. 3. Dependence of the laminar burning velocity s_u of hydrogen compared to methane [16] and kerosene in mixture with air and jet fuel-air mixture [21]

Furthermore, since laminar and turbulent burning velocity for hydrogen air mixture is always much higher than for hydrocarbon air mixtures (Fig. 3), occupation time at the high temperature zone will be lower. Thus, the NOx production will also be lower (turbulent burning velocity is always proportional to the laminar burning velocity). This is mostly because the reaction zone, even for the lean mixtures of hydrogen and air, is much shorter than for Jet A-air mixtures, even for stoichiometric proportion. So combustion chamber for hydrogen-air mixtures can be shorter than a similar one burning jet fuel. In addition, since it is easier to organize the combustion of the lean mixture, it will not be necessary to add a large amount of “cold” air before the first stage of the turbine to decrease its temperature. Those are the benefits of burning hydrogen instead of jet fuel. So to summarize, the application of hydrogen as a fuel from a thermodynamic point of view, will bring many benefits to jet engine combustion chamber. Flame might be easily ignited, will burn in a wider fuel-air mixture range, the maximum temperature in the combustion chamber will be

decreased due to the possibility of effective burning in leaner concentration, and also due to these reasons, production of NOx will be reduced. Therefore, applying hydrogen to jet engine with a modified deflagration combustion chamber will benefit with a few improvements of engine efficiency due to higher work of combustion products containing mostly water vapour and nitrogen, but not CO2 as it is in the engines utilizing classical hydrocarbon jet fuels. Further improvement will be related to the possible cooling of the incoming air by evaporating LH2 in the compressor. This will also benefit with decreasing numbers of turbine stages due to the lower work required to compress air. So even assuming a very conservative approach for evaluating engine efficiency, about 5% improvement is expected. This will result in a decreased mass of LH2 needed to power the propulsion system.

4. Engine with detonative combustion chamber

Detonative combustion of fuel-air mixtures is an alternative solution to classical deflagrative combustion. General differences between those processes are listed in Table 3. As it can be seen from that table, more benefits are for the case with detonation combustion. The hydrogen-air mixture is very easy to detonate, and the detonability limits for the H2-Air mixture are very wide (Fig. 4). The detonability range depends on mixture composition and initial conditions. The detonability range can be even wider for higher initial pressure since detonation is mostly sensitive to the mixture density. The small variation of the initial temperature obviously influences the initial density of the mixture but has a very limited impact on the reaction rate.

Table 3

A comparison of deflagrative combustion vs detonative combustion in jet engine combustion chambers

DEFLAGRATION	DETONATION
Combustion velocity of the order of dozen m/s	Detonation velocity of the order of km/s
Relatively large combustion chamber	Short combustion zone
Combustion at stoichiometric ratio	Combustion (detonation) of lean or rich mixtures
Very high temperature and long occupation time in high temperature zone	Lower occupation time in high temperature zone
High NOx emission	Low NOx emission
Necessity to mix extra air before turbine	No necessity to mix extra air
Pressure drops due to combustion	Pressure increases due to detonation

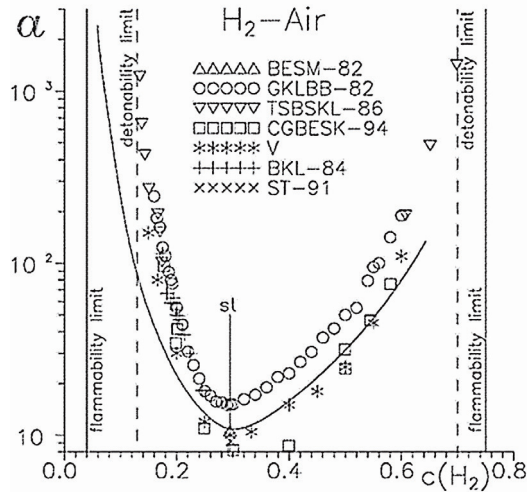

Fig. 4. Detonability range for the H₂-Air mixture at the initial ambient temperature and ambient pressure [32, 37]

Since pressure always increases during the detonation process, the efficiency of the engine cycle, which utilizes this process will be higher than for the cycle with deflagrative combustion. A comparison of the different engine cycles is presented in Fig. 5.

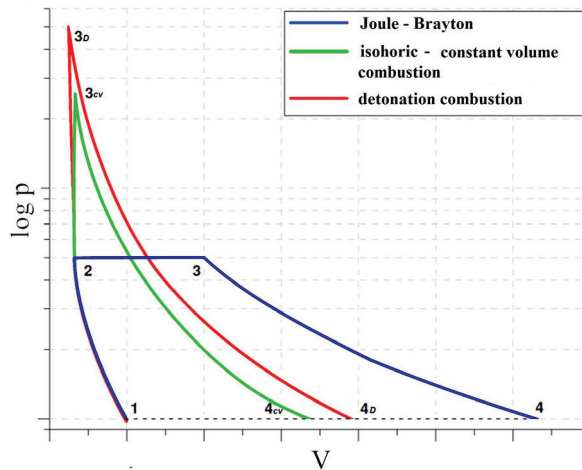

Fig. 5. Thermodynamic cp-Joule-Brayton, cv-Humphrey and det.(Fickett-Jacobs) cycles [courtesy of M. Kawalec]

Theoretical calculations of the efficiency of those cycles for the case of lean hydrogen-air mixture are presented in Table 4. It can be seen that the highest efficiency is for the cycle

with detonative combustion. Such a cycle is usually called Fickett-Jacobs. In a real case, the average pressure generated by detonation in the combustion chamber is lower than C-J pressure (theoretical pressure generated by detonation). Even so, the efficiency of the engine cycle will still be much higher than for the case of deflagrative combustion since the average pressure in the chamber will still be higher than for the Joule-Brayton cycle.

Table 4

Comparison of the calculated theoretical efficiency for hydrogen-air mixture with equivalence ratio equal to 0.5 for cp-Joule-Brayton , cv-Humphrey and det.(Fickett-Jacobs) cycles, for different initial pressure (p/p_0) in the combustion chamber

p/p_0	p_{cv} (bar)	T_{cv} [K]	p_{det} (bar)	T_{det} [K]	η_{cp} [%]	η_{cv} [%]	η_{det} [%]
4	19.1	2083	33.5	2305	32.7	49.3	55.1
6	26.0	2120	44.8	2343	40.1	52.9	58.1
8	32.5	2149	55.5	2372	44.8	55.3	60.2

Research on applications of detonation to the propulsion system was initiated in the mid-fifties of the last century at the University of Michigan (UofM) and initially pulsed detonation (PD) and standing detonation (SD) were considered for such applications [9, 26, 27]. At the beginning of the sixties of the last century, at the Institute of Hydrodynamics (now Lavrentiev Institute of Hydrodynamics) of the Soviet Academy of Sciences, the process of continuously rotating detonation (CRD) was discovered [34–36]. Soon after this, the UofM research was undertaken to utilize CRD process in jet engine combustion chamber [25]. Unfortunately, this attempt failed, but the authors stated at the end of the report that “while successful operation has not been achieved herein, nothing fundamental stands in the way of this accomplishment.” [24]. Only as the results of those research Adamson et al. [29] calculated the proper structure of the CRD in an annular chamber for the heterogeneous mixture and also presented the first rotating detonation rocket engine (RDRE) with aerospike nozzle [1]. At that time, research on the rotating detonation engines (RDE) was interrupted for nearly half of a century and was only reinitiated, nearly simultaneously, at the end of the last century in Russia, France, Poland and Japan [5, 6, 8, 11, 31, 40, 41]. In Poland, research on the application of the CRD to propulsion systems was initiated more than twenty years ago, initially at the Warsaw University of Technology in cooperation with Nagoya University and Mitsubishi Heavy Industry in Komaki, Japan [31, 40, 41]. This resulted in many publications and the first patent on RDE [12, 14, 20, 31, 41, 43–45, 48–50]. More than twelve years ago, such research was also started at the Institute of Aviation (now Łukasiewicz-Institute of Aviation) [22, 37, 39, 46, 47]. Initial research was conducted on the application of the annular detonation chamber to the GTD-350 gas turbine engine [39]. It was possible to operate the engine for jet fuel and jet fuel with the addition of gaseous hydrogen, but no efficiency improvement was recorded. For

the case of engine operation with gaseous hydrogen fuel, very stable operation on CRD mode and improved engine efficiency by 5-7% were recorded [37, 39]. Later, on contract with the US Airforce Research Laboratory, experiments of control of CRD direction were conducted. Basic research was conducted on detonation stability in the annular chamber. Stable detonation in liquid fuel-air mixtures and the first world's successful research of detonation of liquid fuels with air mixtures were achieved [18, 19, 38, 47]. The biggest achievement of the research conducted at the Łukasiewicz-Institute of Aviation was the development of liquid propellant rocket engines which utilize CRD. Such an engine, with regenerative cooling, was used to power the world's first liquid propellant rocket, supplied by storable propellants, liquid propane and liquid nitrous oxide, which was successfully launched on 15 September 2021 [17].

Further research on the CRD in an annular chamber was also conducted at the Łukasiewicz Institute of Aviation. A schematic diagram of the test stand used for this research is presented in Fig. 6. The hydrogen and air are supplied to the annular chamber from the high-pressure bottles and the rate of supply of each component is measured/controlled by Venturi gauges. To initiate detonation in the chamber, an electrical ignite is applied. The Kastler or the PCB pressure sensors measure the pressure variations in the annular chamber. This chamber is attached to the test stand by a horizontal movable sled, which allows for measurements of generated thrust by the chamber by the installed dynamometer. All sensors are connected to the computer, which controls the test's operation and collects/records all signals from installed sensors. Since the chamber is uncooled test usually lasts less than one second, but during this time, hundreds of cycles were measured and recorded. The typical pressure signal recorded for the stable operation is shown in Fig. 7.

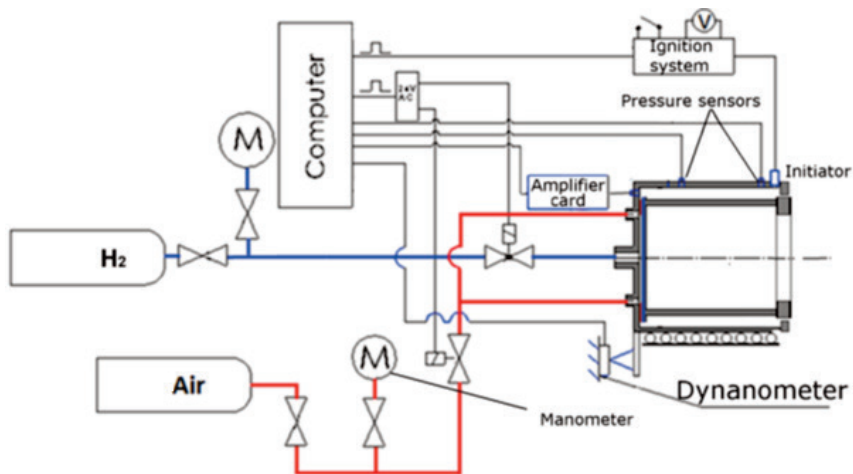

Fig. 6. Schematic diagram of test facility of cylindrical detonative chamber supply by gaseous hydrogen and air

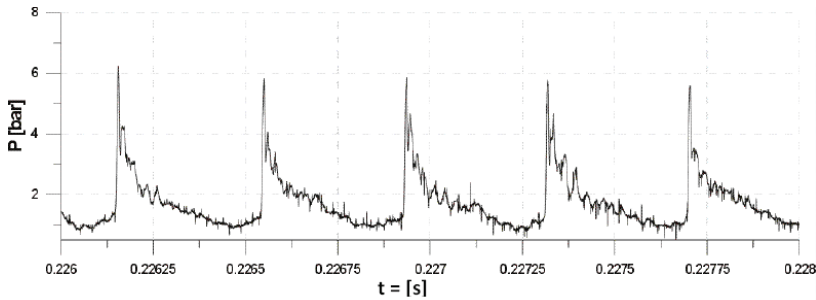

Fig. 7. Typical pressure variation for the stable continuously rotating detonation in cylindrical chamber

The wave stability of the CRD depends mainly on a few factors, such as mixture composition, chamber geometry, initial pressure in the chamber and the rate of mixture supply. A detailed description of the conditions required to obtain stable operation in the chamber can be found in many publications [47]. Besides the stability of the CRD, the most important factor is the Pressure Gain (PG) in the chamber. Many research activities are focused on finding chamber geometry which will guarantee PG. The biggest problem in achieving positive PG is associated with chamber design. To have a stable operation, no backflush of detonation or just back pressure to the supply area ahead of chamber very small contraction is used. This, however, generates big pressure losses, which are difficult to compensate by DC in the chamber. Usually, in the typical jet engine combustion chamber utilizing deflagrative combustion, the pressure drop is about 5% (due to deflagration and pressure losses on chamber elements), so PG in a detonative chamber higher than that will result in an improvement of the engine's performance. But even higher PG is still the aim of most recently conducted research activities. So the biggest effort is to decrease pressure losses at the entry to the chamber. Recent numerical analyses show that positive pressure gain can be obtained by properly designing an annular detonation chamber [2]. If all this is achieved and problems overcome, there is a possible engine configuration utilizing CRD, which, compared to the classical engine, is presented in Fig. 8.

Additional problems that must be solved before introducing detonative combustion to jet engines powered by LH2 are very intensive thermal and mechanical loads created by CRD. In the detonation chamber, there will be high-pressure and high-temperature zone created by continuously rotating detonation wave. This will be a small section of the chamber where very high pressure and temperature associated with the detonation front will be generated. Special high-temperature and high-pressure material should be developed to ensure engine operation for thousands of hours. Additionally, these loads will be of very high frequency, so they will generate high-frequency thermal and mechanical loads in the chamber, which will be a significant problem for the designer of the combustion chambers. Moreover, the application of hydrogen will create another significant problem for all deflagrative and detonative chambers and many other engine elements directly imposed on

gaseous hydrogen. Gaseous hydrogen usually generates embrittlement problems, but the following chapter will be solely devoted to this issue.

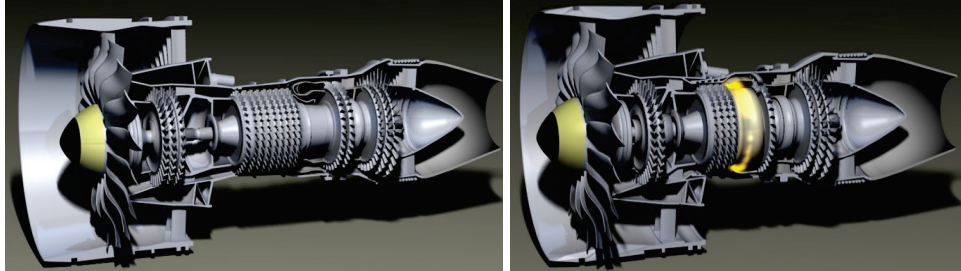

Fig. 8. Possible engine configurations with different combustion chambers. On the left: a classical – deflagrative combustion chamber. On the right: with detonation combustion chamber [courtesy of M. Kawalec]

5. Hydrogen embrittlement

Hydrogen atoms are small and can permeate many metals. Once absorbed, hydrogen lowers the stress required for cracks in the metal to initiate and propagate, resulting in embrittlement. Hydrogen embrittlement occurs most notably in steels and in iron, nickel, titanium, cobalt, and their alloys. Copper, aluminium, and stainless steels are less susceptible to hydrogen embrittlement. To use hydrogen as an aircraft fuel, one needs to consider resistant material for the fuel supply system, including tanks, valves, pipes, fuel nozzles, etc., and the combustor chamber itself. Another option may be a combustion process design that prevents direct contact of unburned hydrogen with combustor chamber elements. This issue is even more valid when the material is exposed to hydrogen at high temperatures. It is also important that hydrogen combustion be complete in the combustion chamber since even a small percentage of unburned hydrogen in the combustion products could produce cracks in guided vane of the turbine and, even more important - of turbine blades. Even a very small unburned amount of hydrogen can be destructive for the turbine and lead to engine failure. Also, for this reason, liquid hydrogen cannot be used for cooling engine elements until a very special material is used to design those engine's elements.

A separate problem is hydrogen embrittlement in the process of hydrogen production, storage and transport. It requires research and validation tests and, later on, massive investment in the infrastructure. When talking about storage, one needs to remember that permeability creates fuel losses and safety issues for people and the environment. Suppose liquid hydrogen is going to be stored and transported. In that case, it is connected with a low temperature of a few K, and that creates serious issues for materials and safety of a different kind.

6. Cost and availability

When considering hydrogen as an alternative fuel, it is necessary to consider the overall cost. One thing is the cost of hydrogen itself, which nowadays is much higher than traditional fuels, not only jet-A but also SAF. Even if the cost of traditional fuels increases due to special regulations aiming at environmental protection promotion to limit the warming climate effect and the cost of hydrogen decreases by alternate energy sources promotion, it is still a problem with hydrogen availability since no mass production is foreseen in the near future and excessive cost of infrastructure required to generate it, store and transport. Moreover, all airports need to reconsider and rebuild their fuel infrastructure, keeping recent plane configuration flying. It will require keeping both: traditional and hydrogen fuel installations parallel for decades until the last plane powered by traditional fuel is in operation. A separate issue that needs to be overcome is people/crew awareness, which may be even more difficult in this transition period.

7. Discussion and Conclusions

Hydrogen is the most energetic fuel as concerns the availability of gravimetric energy, but has very low specific density and the lowest volumetric energy from all recently considered aircraft fuels. Furthermore, the specific density of liquid hydrogen is only 71 kg/m³ and the boiling temperature at atmospheric pressure is only 20K, so for storage of such fuel very large tanks will be required. Such tanks must be made from special materials resistant to very low temperature of about -253°C. In addition, to prevent leaks or gaseous hydrogen by diffusion through tank walls, super materials and super thermal isolation will be required to minimize hydrogen losses from evaporation during storage and aircraft standing at the airport or special super refrigeration installation will be needed at each aircraft to re-liquefy evaporating hydrogen. All materials used for storage and distribution of liquid/gaseous hydrogen from tanks to the combustion chambers should be made from such alloys, which will be resistant to embrittlement during contact with hydrogen. Thus, many additional requirements for storing liquid hydrogen on board of aircraft should be addressed. Liquid hydrogen will have to be evaporated before injection into the combustion/detonation chamber of jet engines, so it will be used to cool down engines' elements such as turbine vanes and blades and combustion chamber. It could also be used to cool air incoming to the engine compressor. This will significantly decrease the power/energy needed to drive the compressor, so as a result, fewer turbine stages will be required, and the engine will be shorter, lighter and more efficient. The engines' efficiency will increase not only for the above reason but also due to higher thermodynamic work provided by water vapor compared to CO₂, which is always present in combustion products of typical hydrocarbon fuels. Efficiency will also increase if detonation combustion is used in combustion chambers since pressure during detonative combustion rises in such a case.

So it may be concluded that the application of liquid hydrogen to an aircraft propulsion system can cause the following:

- decrease compressor work and eliminate a few stages of the compressor,
- eliminate one or few stages of the turbine,
- improvement of engines' efficiency,
- smaller and lighter engines,
- LH2 used as an efficient coolant for engines' elements,
- LH2 used to cool aircraft's structure at supersonic/hypersonic velocity,
- clean and carbon less emission of combustion products,
- but also on the challenges side:
 - a necessity to lower pressure losses at the entry to the detonation chamber to guarantee the pressure gain in detonative combustion,
 - material development to resist high pressure and high temperature generated in the detonation chamber,
 - problems related to hydrogen embrittlement of many materials, so only special materials can be used to tackle hydrogen storage and supply from tanks to engines,
 - a necessity to produce all engine's/fuel supply system elements and compressor stages (if hydrogen will be used to cool incoming air) which will have contact with liquid/gaseous hydrogen with material resistible to hydrogen embrittlement,
 - Cost of all surrounding installations to produce, transport and store hydrogen,
 - more water vapor production by engine at high altitudes (water vapor and formed ice crystals may affect climate change).

Comparing liquid hydrogen to other alternative aircraft fuels, one should compare the benefits and problems related to their applications. The biggest advantage of hydrogen is clean combustion, higher engine efficiency, and the possibility to cool aircraft engines and structure, especially for hypersonic transport. But hydrogen also brings many problems that must be solved before such fuel is introduced into service. One of them is hydrogen embrittlement, created by hydrogen penetration into metal structure and unexpected fracture of many materials. It is very important to eliminate this problem since no one will tolerate a structure which could fail during operation, especially during aircraft operation high above the ground. So, before introducing liquid hydrogen into wide use as aircraft fuel, many essential problems have to be solved.

Before introducing liquid hydrogen to passenger aircraft' updated analyses of all benefits and problems related to the application of this fuel have to be conducted, especially detailed analyses of all production, storage and transportation aspects. Complex analyses should be conducted to evaluate the general cost and impact on environment limited not only to hydrogen application. It is necessary to consider the cost and impact of the whole installation and system manufacturing, including safety features and procedures, the entire product life cycle, etc. – similar to other trends, e.g. transport electrification. If an analysis is limited to the aircraft itself, it will not provide accurate results.

The CRD technology of combustion in propulsion system is gaining interest in the world's propulsion community due to many potential benefits, such as improving efficiency

by even more than ten percent and reducing the size and mass of the engines. In the case of aircraft engines, it is also a potential benefit visible of reduction of NO_x emission. However, this will require additional research in detonative combustion and associated research areas, such as protection against high thermal and mechanical loads associated with detonative combustion. First applications are already introduced in CRD for rocket propulsion, as mentioned in recent publications [13, 17–19].

Acknowledgement

The author is grateful to all coworkers who were helpful with the preparation of this manuscript for publication, especially M. Kawalec and P. Wolański.

8. References

1. Adamson T.C. Jr., Olsson G.R.: Performance Analysis of a Rotating as a Thrust-producing Mechanism. *Jet Propulsion* 27(5): 1957.
2. Bach E., Paschereit C.O., Stathopoulos P., Bohon M.D.: Advancement of Empirical Model for Predicting Stagnation Pressure Gain in Rotating Detonation Combustors. AIAA SciTech Forum, January 3-7, 2022, San Diego, CA & Virtual; DOI 10.2514/6.2022-0834.
3. Brewer G.D.: The Case for Hydrogen-Fueled Transport Aircraft. *Aeronautics and Astronautics*, May 1974.
4. Bruce S., Temminghoff M., Hayward J., Palfreyman D., Munnings C., Burke N., Creasey S.: Opportunities for hydrogen in commercial aviation. 2020.
5. Bykovskii F.A., Mitrofanov V.V., Vedernikov E.F.: Continuous Detonation Combustion of Fuel-Air Mixtures. *Combustion, Explosion and Shock Waves*, Vol. 33, 1997.
6. Bykovskii F.A., Zhdan S.A., Vedernikov E.F.: Continuous Spin Detonations. *Journal of Propulsion and Power*, V. 22, No. 6, 2006.
7. Calder P.H., Gupta P.C.: Future SST engines with particular reference to Olympus 593 evaluation and Concorde experience. *The Aeronautical Journal*, June 1976.
8. Davidenko D., Jouot F., Kudryavtsev A., Dupré G., Gökalp I., Daniau E., Falempin F.: Continuous detonation wave engine studies for space application. 2nd European Conference for Aero-Space Sciences (EUCASS 2007), Brussels, Belgium, 1-6 Jul., 2007.
9. Dunlap R., Brehm R.L., Nicholls J.A.: A Preliminary Study of the Application of Steady-State Detonative Combustion to a Reaction Engine. *Jet Propul.* 28 (7), 1958.
10. Dwivedi S.K., Vishwakarma M.: Hydrogen embrittlement in different materials: A review. *International Journal of Hydrogen Energy*, 43(46), 2018.
11. Falempin F., Daniau E., Getin N., Bykovskii F.A., Zhdan S.: Toward a continuous detonation wave rocket engine demonstrator. 14th AIAA/AHI Space Planes and

- Hypersonic Systems and Technologies Conference, AIAA2006-7956, Canberra, Australia, 6-9 Nov. 2006.
12. Hayashi A.K., Kimura Y., Yamada T., Yamada E., Kindracki J., Dzieminska E., Wolanski P., Tsuboi N., Fujiwara T.: Sensitivity Analysis of Rotating Detonation Engine with a Detailed Reaction Model. AIAA 2009-0633, 2009.
 13. Heister S.D., Smallwood J., Harroun A., Dille K., Martinez A., Ballintyn N.: Rotating Detonation Combustion for Advanced Liquid Propellant Space Engines. *Aerospace*, 9(10), 581; 2022, DOI 10.3390/aerospace9100581.
 14. Hishida M., Fujiwara T., Wolanski P.: Fundamentals of rotating detonation. *Shock Waves*. 19, 2009.
 15. Hydrogen Powered Aviation report, pdf, web (ID 8706035).
 16. Jones W.P., Tyliszczak A.: Large Eddy Simulation of Spark Ignition in a Gas Turbine Combustor. *Flow Turbulence Combust*, 85:711–734, 2010, DOI 10.1007/s10494-010-9289-9.
 17. Kawalec M., Perkowski W., Łukasik B., Bilar A., Wolański P.: Applications of the continuously rotating detonation to combustion engines at the Łukasiewicz – Institute of Aviation. *Combustion Engines*, 191(4), 2022, DOI 10.19206/CE-145409.
 18. Kawalec M., Perkowski W., Wolański P.: Development of Rocket Engines with Detonation Combustion Chamber. In: *Research on detonative propulsion in Poland*, ed. Wolański P., pp. 163-181, Institute of Aviation Scientific Publication, Warsaw 2021.
 19. Kawalec M., Wolański P.: Development of Rocket Engine with Continuously Rotating Detonation supplied by Liquid Propellants. *Proceeding of EUCASS*, Lille, France, 27 June-1 July, 2022.
 20. Kindracki J., Wolański P., Gut Z.: Experimental research on the rotating detonation in gaseous fuels-oxygen mixtures. *Shock waves*, 21:75–84, 2011, DOI 10.1007/s00193-011-0298-y.
 21. Kordylewski W. (ed.): *Spalanie i paliwa*. Wrocław 2008.
 22. Kublik D., Kindracki J., Wolański P.: Evaluation of wall heat loads in the region of detonation propagation of detonative propulsion combustion chambers. *Applied Thermal Engineering* 156, 2019.
 23. Mangold J., Brenner F., Moebs N., Strohmayer A.: Aircraft Design Implications of Alternative Fuels for Future Hybrid-Electric Regional Aircraft Configurations. 9th European Conference for Aeronautics and Space Sciences (EUCASS), 27 June - 1 July 2022, Lille, France.
 24. Nicholls J.A., Cullen R.E.: The Feasibility of a Rotating Detonation Wave Rocket Motor. The Univ. of Mich., Report No. RPL-TDR-64-113, 1964.
 25. Nicholls J.A., et al.: The Feasibility of a Rotating Detonation Wave Rocket Motor. The Univ. of Mich., ORA Report 05179-1-P. 1962.
 26. Nicholls J.A.: Wilkinson H.R., Morrison R.B.: Intermediate Detonation as a Thrust-producing Mechanism.” *Jet Propulsion* 27(5), 1957.

27. Rutkowski J., Nicholls J.A.: Consideration for the Attainment of a Standing Detonation Wave. Proceedings of the Gas Dynamics Symposium, Northwestern University, 1956.
28. Scholz D.: Design of Hydrogen Passenger Aircraft – How much “Zero-Emission” is Possible?; Hamburg Aerospace Lecture Series (DGLR, RAeS, VDI, ZAL, HAW Hamburg), Hamburg, Germany, 2020-11-19; DOI 10.5281/zenodo.4301104.
29. Shen P.I., Adamson T.C. Jr.: Theoretical Analysis of a Rotating Two-Phase Detonation in Liquid Rocket Motors, *Astronautica Acta* 17: 1972.
30. Sosounov V., Orlov V.: Experimental Turbofan Using Liquid Hydrogen and Liquid Natural Gas as Fuel. Proceedings of the AIAA—26th Joint Propulsion Conference, Orlando, FL, USA, 1990.
31. Tobita A., Fujiwara T., Wolanski P.: Detonation Engine and Flying Object Provided therewith Publication Data: 2005-12-29; Japanese Patent No. 2004-191793 (granted 2009), Patent US 7784267 (granted 2010).
32. Vasiliev A.A. Cell Size as the Main Geometric Parameter of a Multifront Detonation Wave. *Journal of Propulsion and Power*, 22(6): 2006.
33. Verstraete D., Hendrick P., Pilidis P., Ramsden K.: Hydrogen fuel tanks for subsonic transport aircraft. *International Journal of Hydrogen Energy*, 35(20), 2010.
34. Voitsekhovskii B.V., Mitrofanov V.V., Topchiyan M.E.: Structure of the Detonation Front in Gases.” Izdatielstvo SO AN SSSR. Novosibirsk (in Russian), 1963.
35. Voitsekhovskii B.V.: Stationary spin detonation. *Soviet Journal of Applied mechanics and Technical Physics*, vol. 3, 1960.
36. Voitsekhovskii B.V.: Statsionarnaya dyetonatsiya. *Doklady Akademii Nauk SSSR*, 129(6), 1959.
37. Wolański P. (ed.): Research on detonative propulsion in Poland. Institute of Aviation Scientific Publication No. 60, Łukasiewicz Research Network – Institute of Aviation, Warsaw 2021.
38. Wolański P., Balicki W., Perkowski W., Bilar A.: Experimental Research of Liquid Fueled Continuously Rotating Detonation Chamber. *Shock Waves*, 2021, DOI 10.1007/s00193-021-01014.
39. Wolański P., Kalina P., Balicki W., Rowiński A., Perkowski A., Kawalec M., Łukasik B.: Development of gasturbine with detonation chamber. *Detonation Control for Propulsion, Pulse Detonation and Rotating Detonation Engines*, Springer: Cham, Switzerland, 2018, pp. 23-37.
40. Wolański P., Kindracki J., Fujiwara T., Oka Y., Shima-uchi K.: An Experimental Study of Rotating Detonation Engine. In Proceedings of the 20th ICDERS, Minsk 2005.
41. Wolanski P., Kindracki J., Fujiwara T.: An Experimental Study of Small Rotating Detonation Engine. Proceedings of the Fifth International Colloquium on Pulsed and Continuous Detonations, Moscow, Russia, July 3-7, 2006.
42. Wolański P.: Alternatywne paliwa lotnicze do silników turbinowych. *Technika Lotnicza i Astronautyczna*, Nr 2, 1987.
43. Wolański P.: Detonation Engines. *Journal of KONES*, Vol. 18 (2011), No.3 pp.515-521.

44. Wolański P.: Detonative Propulsion. Proceedings of the Combustion Institute, 34, pp.125-158, Elsevier, 2013.
45. Wolanski P.: Development of the continuous rotating detonation engines. In: Progress in Pulsed and Continuous Detonations, ed. by G.D. Roy and S.M. Frolov, Moscow, Torus Press, 2010.
46. Wolański P.: RDE research and development in Poland. Shock Waves, 2021, DOI 10.1007/s00193-021-01038-2.
47. Wolański P.: Rotating Detonation Wave Stability. In: Research on detonative propulsion in Poland, ed. Wolański P., pp. 71-92, Institute of Aviation Scientific Publication, Warsaw 2021.
48. Yi T.-H., Lou J., Turangan C., Choi J.-Y., Wolanski P.: Propulsive performance of a continuously rotating detonation engine. Journal of Propulsion and Power, vol. 27, 2011.
49. Yi T.H., Lou J., Wolanski P., Turangan C., Khoo B.C.: Effect of nozzle shapes on the performance of continuously rotating detonation engine. AIAA paper 2010-0152, 2010, DOI: 10.2514/6.2010-152.
50. Yi T.-H., Turangan C., Lou J., Wolanski P., Kindracki J.: A three-dimensional numerical study of rotational detonation in an annular chamber. AIAA 2009-0634. 2009.

