



CONDITIONS OF USAGE ANALYSIS OF THE TWO-STROKE, SLOW-RUNNING, HIGH POWER RATING, MAIN ENGINES AND THE CAUSES AND EFFECTS OF THE TRIBOLOGICAL SYSTEMS DAMAGE

Zbigniew Łosiewicz

*West Pomeranian University of Technology Szczecin
Faculty of Maritime Technology and Transport
Chair of Safety Engineering and Power Engineering
tel. 600 275871
e-mail: horn.losiewicz@wp.pl*

Abstract

This work justifies the need for further research, both laboratory and real-time usage, on improving currently operating diagnostic systems adapted to monitor ship's two-stroke, slow-running high power rating main engines in order to prevent the damage of the main tribological systems of the engines, at least these mentioned in the paper. The randomness of the variability of the load of the engines is highlighted. It is pointed that the load should be taken under consideration during the period of usage of the engines as random processes, but the optional period of time of usage as random variables. The models of these processes which are necessary to the research are offered to be elaborated with the use of Semi-Markov model theory. The rationality of the proposition is pointed out with two hypotheses. The first explains the relation between the mechanical load $Q_M(t)$ and the thermal load $Q_C(t)$ of the engines. The second - the existence of the stochastic linear relation between the load $Q_M(t)$ and $Q_C(t)$ of the engines and the wear $Z(t)$ of their main tribological systems in such relation, that the value of the correlation coefficient $r_{qz}=1$. In order to simplify the actions made to improve the currently used diagnostic systems of the engines mentioned; the most relevant description according to the author of chosen tribological system damage is given. The conditions of usage which favor the described damage are also characterized.

Keywords: *hypothesis, load, two-stroke engine, tribological system, damage, conditions of usage, wear*

1. Introduction

The conditions of usage of the main ship engines, particularly two-stroke, slow-running, high-power engines are more diversified in relation to other piston diesel engines in the main ship's drives. The conditions are dependent not only on hydro meteorological sea conditions shaped by factors such as [3]: the windforce and its direction, the state of the sea resulting from the height, length and direction of the waves, the direction of the currents, the depth and the width of the water region in which the ship is moving, the precipitation (rain, snow, hail), the icing, deck flooding, etc. They are also dependent on maneuvering conditions in the ports and navigation waterways which forces the reduction of rotary speed along with the engine power. This negatively affects the load of its tribological systems such as piston-ring-cylinder tubes, main and crankshaft bearings and crosshead bearings. The conditions change in a random manner, so the load of the main engines, both thermal and mechanical have random properties. This is the cause

to consider the load when the engines are running as random processes and their research should be conducted with the use of scholastic processes theory - especially the Semi-Markov theory [4, 5]. Accordingly, the load given in a specific moment of the ship's engines usage is considered random variable. This means, that the values of the load cannot be precisely predicted, but their probability of occurrence may be estimated. The load affects the tribological engine systems negatively making the processes random. The processes lead to boundary wearing (superficial or volumetric) of the engines and in result to their damage. These are the reasons to pursue the recognition of the properties of engine load and its effects such as excessive wearing and damage to the specific tribological systems of the main engines, which are the most important elements when considering the durability and reliability of such type of engines.

This is taken under consideration in further parts of the paper, starting from the analysis of the conditions of usage of the two-stroke, slow-running high power engines.

2. The analysis of the conditions of usage of the two-stroke, slow-running high power engines

Recent research shows that some of the values considered as parameters (indicators) of work of the piston diesel engines such as: average usable pressure (p_e), average piston speed (c_{sr}) [1, 6, 7, 8, 9], are characterizing both thermal and mechanical load. It is obvious that there is a relationship between the mechanical load and thermal load. Due to the fact that the loads occurring in time are random processes there is a conclusion that there has to be a stochastic relation between them. Therefore a following hypothesis forms ***H1 [2] There is a stochastic relation between the mechanical load $Q_M(t)$ and thermal load $Q_C(t)$ because specific versions of the mechanical load $Q_M(t)$ accompany various versions of thermal load Q_C .*** The conclusion is that the relation between these load processes $Q_M(t)$ and $Q_C(t)$ cannot be described as a result of use of casual algebraic equation [13]. The relation is influenced by many immeasurable factors [14, 16, 19, 21, 22]. Therefore the level of relation between $Q_M(t)$ and $Q_C(t)$ may vary. In conclusion, there is a need of taking into consideration the intensity (force) of the stochastic relation between Q_M and Q_C which requires long-term and costly statistical research. The load causes the wearing of the tribological systems of every engine. So the course of wearing is also a random process which is irreversible and its valuation is conditioned by the load of the engine [1, 7, 8, 9].

Therefore one can assume a hypothesis (***H2 [2] when rationally using a diesel engine, the wearing (Z) of each tribological system and its load (Q) are strictly connected random variables, because one can find that there is a linear stochastic relation such as: the value of the correlation coefficient $r_{qz}=1$.*** In conclusion, with rational usage the increase in load causes increased wear and vice versa - decreased load causes less wear of the tribological systems in the same time range. Moreover, due to the stochastic properties of the load of the tribologic systems also the process of wearing of these systems is a random variable. This means that the appearance of the boundary usage and damage connected to it is a random event. This is the main cause these events cannot be correctly predicted but only estimated in terms of probability of their occurrence. Diversified (random) loads cause irregular usage of specific tribological systems along with random speed of diesel engine wear. This makes it important to identify the features of wear of the tribological systems in practical operation.

Given that two-stroke, slow-running, high-power engine of the main ship's drive should be adapted to work in an unlimited water region, one needs to analyze the factors influencing its usage process. These factors are:

1. Engine working conditions - randomly varied, such as:
 - random sea weather conditions (waves, wind, heels, water and air temperatures) subject to constant change in time and intensity,

- random load caused by: port maneuvers, river and channel navigation, hull fouling, changing the course in relation to wave and wind direction, weight of the load and changing conditions of usage.

2. Qualifications of the engine's users - picked at random:

- the crew is certified and IMO approved (convention STCW 95) but this doesn't guarantee high qualification (this is dependent on the level of training and examination in IMO approved centers). These centers often do not meet expectations especially in terms of maintenance prophylaxis or engine damage. The crew is not working properly even if the shipowner takes care of the ship by providing spare parts and not abuses the engines.

- the crew comes from different countries and has different technical culture,

- the crew's physical condition is various and dependent on their health. It is also affected by long-term voyages, the intensity of their work, the ship's technical state, physical exhaustion, family problems and the "atmosphere" onboard.

3. Legislation, with specific instructions to follow. They arise from valid rules, restrictions, air and water pollution limits. The ship is used on international waters or territorial waters so it has to meet all legal expectations of the waters. The main legislative bodies are:

- International Maritime Organization (IMO) as main international organization, the United Nations branch, which states the worldwide rules.

- countries' administration - in their legal acts they accept IMO rules, and very often rise the standards in relation to their territorial waters.

4. Binding law and its regulations such as:

- main legal regulations - IMO, conventions SOLAS 74, MARPOL 73/78,

- local regulations - i.e. HELCOM (Baltic Sea and UE organization) - Helsinki Convention, US Coast Guard regulations, Canadian Ministry of Transport regulations,

- usage assumptions - the needs and requirements of the ship-owner

- additional regulations extending the safety - classification companies rules.

During the usage of the main ship's engine (OSG) when at sea, the weather conditions cause often wear of the tribological systems leading to their damage. Unfortunately, the damage appears despite the use of diagnostic systems (SDG) on the diagnosed systems (SDN), which are the two-stroke, slow-running, high power engines. Therefore the SDG have to be improved in order to prevent the damage described in the next part of the paper.

3. The description of the damage to the tribological systems of the two-stroke, slow-running, high power main engines

During the usage of the OSG both the manufacturer and the user gather information about its damage, which consists of its working duration (until damaged), the cause of the damage and its effects, the maintenance leading to its repair. etc. This makes it possible to describe the damage to the tribological systems of the OSG, which occurred despite the use of diagnostic systems (SDG) on the diagnosed systems (SDN).

The research shows, that (drawing 4.1) one can distinguish three zones (I,II,III) of the engine, in which the main damage to the tribological systems and other parts and components of the OSG is the influence of factors dominating in the processes (chemical and physical) that occur during conversion and transmission of energy to the propeller [27]. The factors are the forces creating friction and related to it grinding use, stresses, which wear the material leading to fractures and relatively high temperature favoring the adhesive wear and finally chemically aggressive environment favoring corrosive wear.

Zone I - in this zone the dominant process is combustion in the combustor at the time which the main factors are high temperature and aggressive chemical emission. They lead to wear of the pistons, cylinder sleeves, and rings of the engine.

Zone II - here the dominant process is the transmission of the mechanical energy leading to damage of pistons, rings, cylinder sleeves, main bearings, crankshaft bearings and crosshead bearings.

Zone III - here the dominant processes are the vibrations, which lead to wear and damage to main bearings, crankshaft bearings and crosshead bearings.

However it is important to know that it is basically impossible to determine the soul cause of the damage caused to the tribologic system of the engine. It is possible that sometimes incorrect assembly or imprecise quality of the element is the reason to generate more destructive factors such as, i.e. vibrations, noise, technical dry friction and other events.

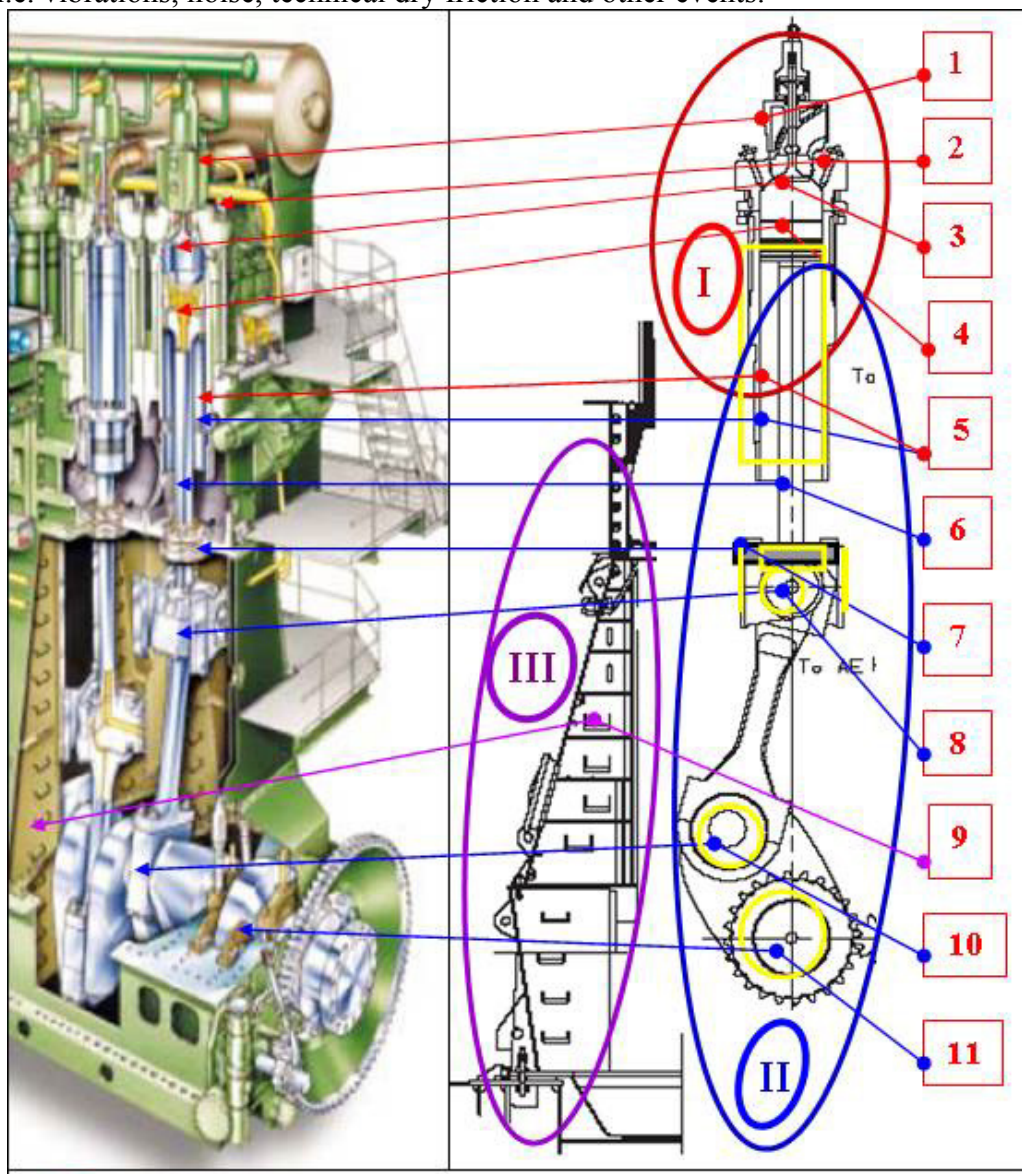

Fig. 1. Cross-section of the structural SG and its damaged zones by the dominating factors [14]:

Zone 1: 1- exhaust valve basket, 2 - fuel injection valve, 3 -exhaust valve head, 4 - piston, 5 - cylinder sleeve,

Zone 2: 5 -cylinder sleeve, 6 - piston rod, 7 - piston shank choke, 8 - crosshead bearing, 10 - crankshaft bearing, 11 - main bearing,

Zone 3: 9 - engine frame

Zone I (Fig.1) is a part of construction structure, in which the main factor of previously described damage of the SG is thermal energy generated in the process of combustion in the combustor.

In the second picture (Fig. 2) one can notice a fracture of the piston casing's collar where the piston's head, casing and shank are combined

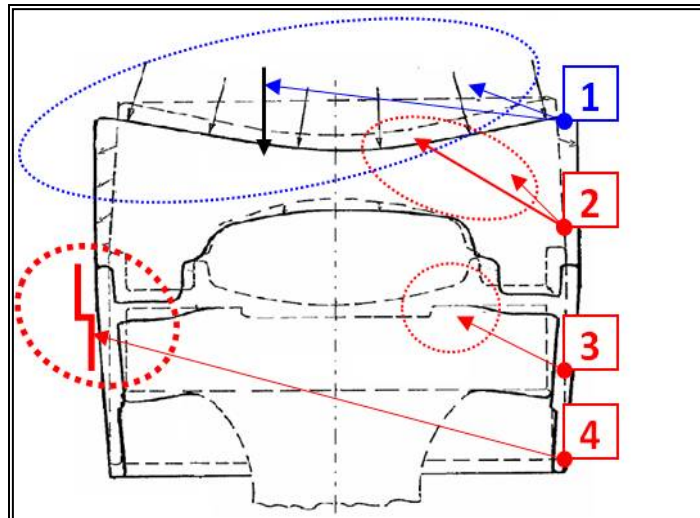

Fig. 2. The deformation of the piston's head and casing due to combustion gas force activity [17]:
 1 - gas forces, 2 - deformation of the piston caused by heat and gas forces, 3 - stress causing deformation, 4 - relatively high deformation in the vicinity of the telescopic tube and friction of the piston casing's collar

The friction occurred on the outside of the collar which joins the head with the piston casing. It took place after several thousand working hours (failing to comply with the limits anticipated between the overhauls TBO (Time Between Overhauls), due to material fatigue. The reason for that was the use of constructional solutions of the older generation of engines in the newer types, in which higher thermal load and higher stress occurred. The cause of the load/stress were superior pressure combustion gases.

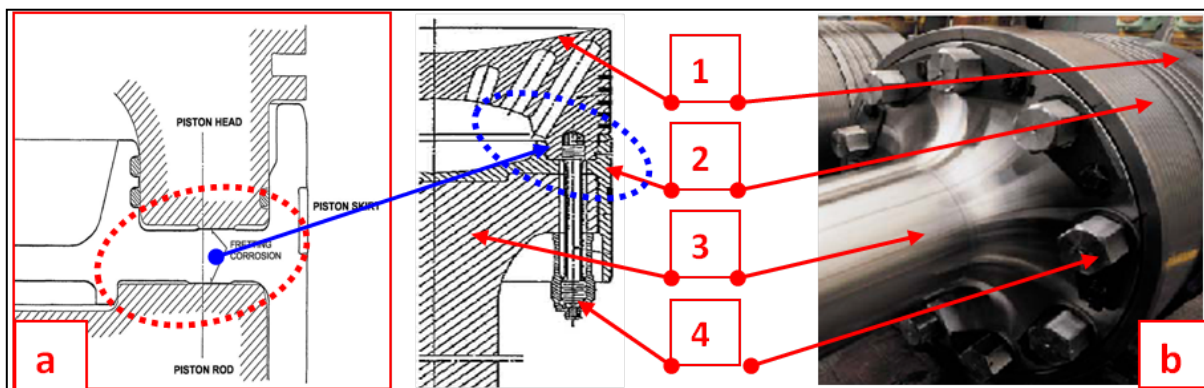

Fig. 3. a) piston casing's collar surface influenced by fretting corrosion, b) parts of the piston mutually co-operating with the cylinder sleeve: 1 - head, 2 - piston casing, 3 - piston shank, 4 - linking bolt of the head, casing and shank [18]

Fig. 3 describes the wear of the piston casing's collar due to frictional corrosion of the planes contacting the piston casing's collar with the head and the shank of the piston. The cause of such damage is the pressure occurring due to the combustion gases of greater pressure than anticipated in design. The gases cause deformation of the piston, friction of the piston collar and piston part displacement leading to frictional corrosion. The corrosion causes material loss of ca. 0,01 mm/1000h and lowering of the elastic pressure in the bolt which links the parts.

Fig. 4 shows the damage to the grooves of the piston rings inside the head of the piston. The reason of the damage is the loss of material caused by frictional corrosion leading to piston groove size alteration.

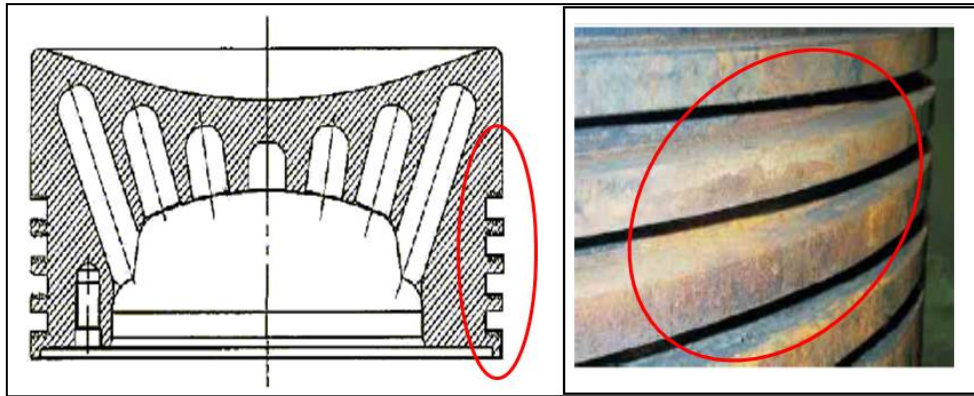

Fig. 4. Head of the piston with the piston grooves plated with chromium layer.

The cause of such damage are normal processes of the material loss due to the piston ring work in the grooves (happening in shifting sea weather conditions) and additional factors causing chemical-frictional corrosion. Improper use of the engine leads to thermal pressure increase, piston material overheating, carbon deposit occurrence and high-pressure corrosion caused by aggressive sulfur compounds created when residual fuel is combusted.

Fig. 5 and 6 show the damage to the surface of the piston head's bottom. Fig. 6 displays three types of the bottom's surface damage. In the picture are shown:

- corroded material layer on the wide area of the bottom (a),
- local loss of material caused by erosion (b),
- deep loss of material caused by burnup (c).

The causes of such damage are;

- corrosion of the piston bottom's surface (known as "sett block structure" or "elephant skin"), which is caused by high-temperature corrosion and by sulfur, vanadium and sodium compounds in the residual fuel (a) in the Fig. 6; the layer of the corrosion products if thin ($<0,2$ mm/1000working hours), uniform and coherent then has protective properties; when damaged, in the place of damage often occur (invisible for the human eye) corrosion pits.
- high-temperature corrosion and erosion, happening on the areas of the piston's bottom, which is subject to flame dynamics and streams of hot combustion gas, which leads to loss of the bottom's material (b) in the Fig. 6,
- improperly sprayed and leaking fuel (from the damaged injection valve), which percolates into the carbon deposit, burns on the surface of the piston's bottom creating deep pinholes (c) in the Fig. 6.

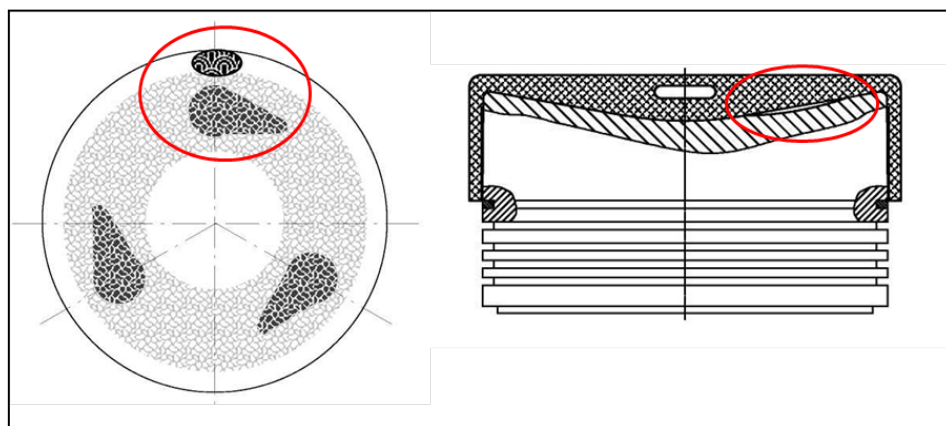

Fig. 5. The loss of material on the surface of the piston bottom [20]

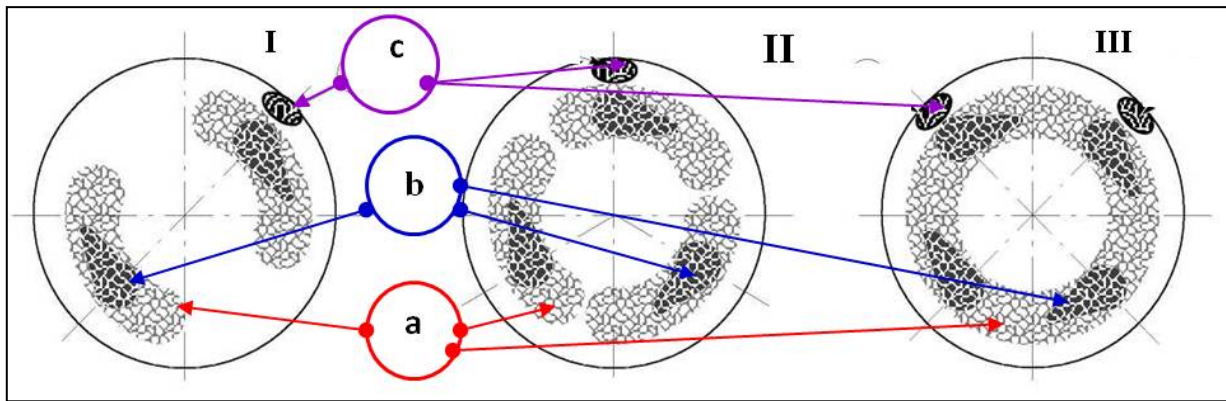

Fig. 6. Types of damage to the surface of the piston bottom for the types of engines with [21]:
 I - two injection valves, II - three injection valves, III - four injection valves, a - corrosion layer, b - local, erosive material loss, c - deep material loss caused by burnout

The above mentioned phenomena occurrence and the meaning of the consequence of their occurrence is influenced by:

- increased temperature of the surface of the piston bottom caused by release of carbon buildup on the surface of the cooling oil holes inside the piston which render the cooling difficult (1 mm thick buildup causes the increase of temperature by 200 °C),
- insufficient air charging caused by impurities in filter, compressor or turbo-compressor turbine, air cooler, utilization pot or the silencer,
- correctness of the using process

On the other hand, the Fig. 7 displays the examples of piston bottom damage, which are the result of occurrence of the causes described above.

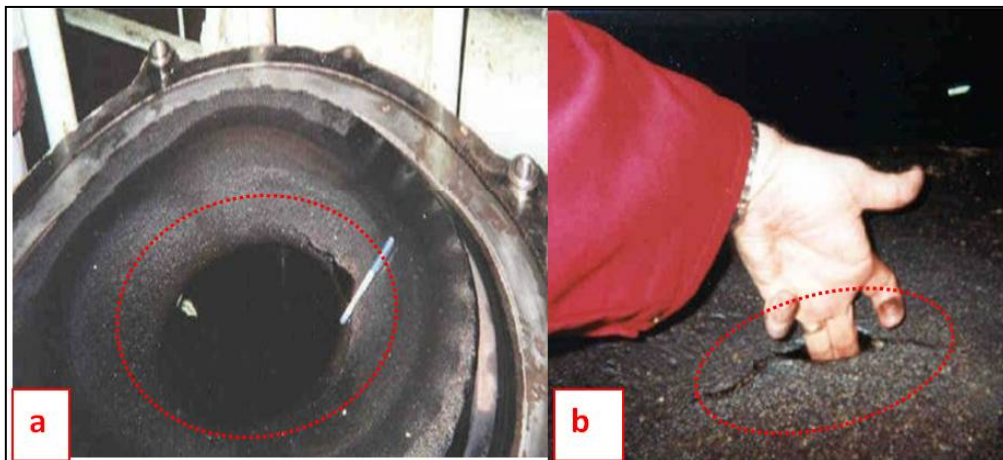

Fig. 7. Examples of extreme piston bottom damage [25]:
 a) burnout hole caused by bad long-term fuel spraying and piston surface burning, b) damage caused by improper piston cooling

Fig. 8 shows damage to the piston rings installed in the head of the piston.

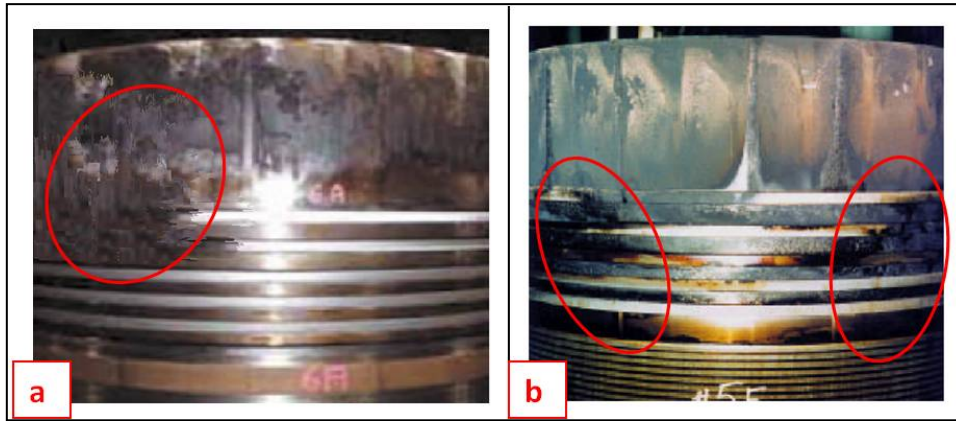
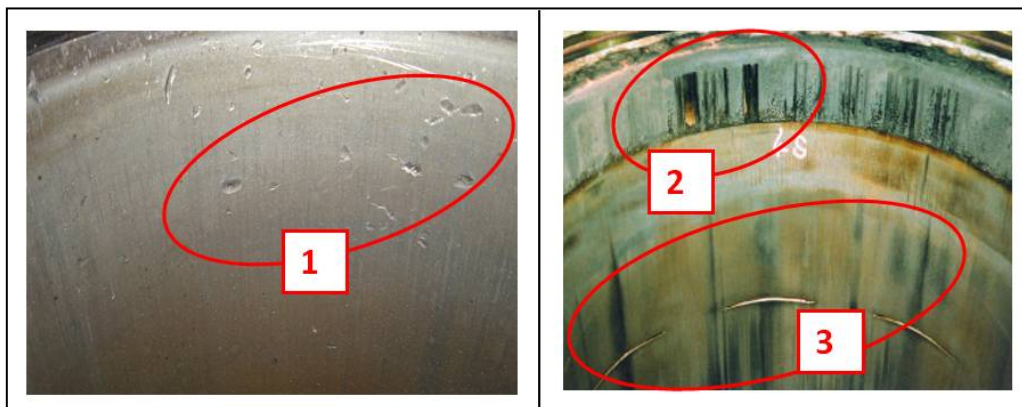

Fig. 8. Piston rings are abraded, they crack and break [25]

The damage shown in Fig. 8 points out the loss of piston rings. The reasons of such damage are construction errors coming from the use of construction solutions from the older types of engines in newer ones (which have different operating parameters). The damage occurs also due to DTR incompatible (technical-movement documentation) process of grinding-in [15, 16], using of non-original spare parts, improper piston-cooling media selection. Moreover, the damage is caused by improperly prepared cooling media and keeping improper parameters of work of the media [15, 16], invalidly prepared fuel [77], damage to the injection valve, wrong shape of the injection valve (count, size, direction of the sprayed fuel) [19].

In the Fig. 9 one can observe a damage to the inner surface of the cylinder sleeve.



*Fig. 9. Damage to the surface of the inner cylinder sleeve [26]:
1 - mechanical damage by particulate solids, 2 - frictional corrosion, 3 - pinhole corrosion*

The damage displayed in the Fig. 9 is the shape change of the sleeve caused by electro-chemical, frictional, pinhole corrosion. Therefore the causes of the damage are:

- electro-chemical corrosion caused by sulfur acid created from high amount of sulfur in the residual fuel and high amount of water from the air pressure charging which liquefies on cool sleeve walls.
- frictional corrosion caused by particulate solids from the outside - from the process of combustion, friction and grinding of the piston parts, rings and sleeves.
- pinhole corrosion caused by improper lubrication of the sleeve surface (wrong or badly prepared oil, misplaced lubrication holes, or bad honing of the sleeve), when highly loaded - inadequately running injection apparatus.
- corrosion of the lower part of the sleeve caused by too-low pressure charging temperature, or too much water in it (bad work of the dehumidifier in the below-piston area).

Fig. 10 shows damage to the connecting rod's head. The damage is caused by alteration of the head's structure on the contact surface with the bottom bearing liner. The bearing overheats from excessive wear of sliding surface.

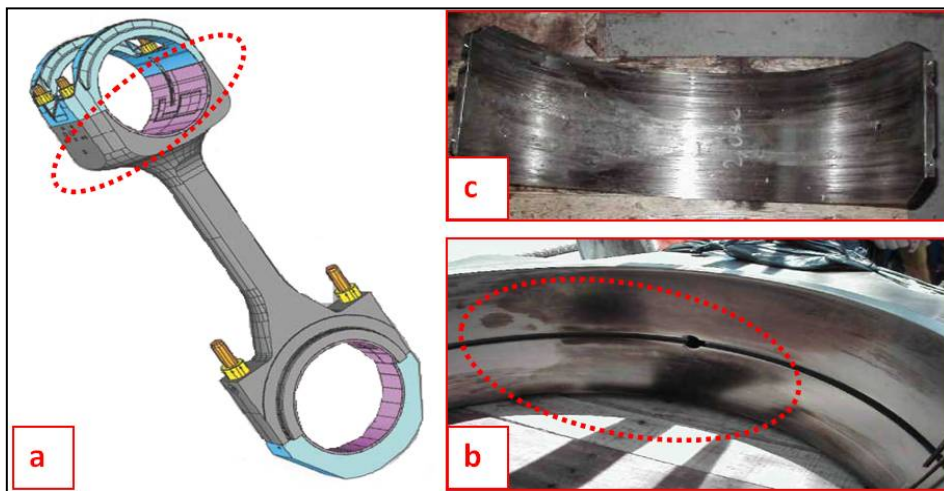

Fig. 10. Connecting-rod [22, 24]: a) damage to the connecting rod's head where the lower bearing liner is adjoined, b) traces of overheating of the contact surface of crosshead's lower bearing liner, c) destroyed lower bearing liner

In the Fig. 11 one may observe the damage of the sliding coating of the bearing liner of the main engine bearing, which bears the marks of seizing. The cause of the damage is too long period between overhauls, along with improper smear oil processing, which leads to particulate solids layering. Also chemical constitution of the oil affects the coating damage ("used oil"), and external pressure due to bearing misuse. One may assume the marks of seizing are the result of oil film stoppage.

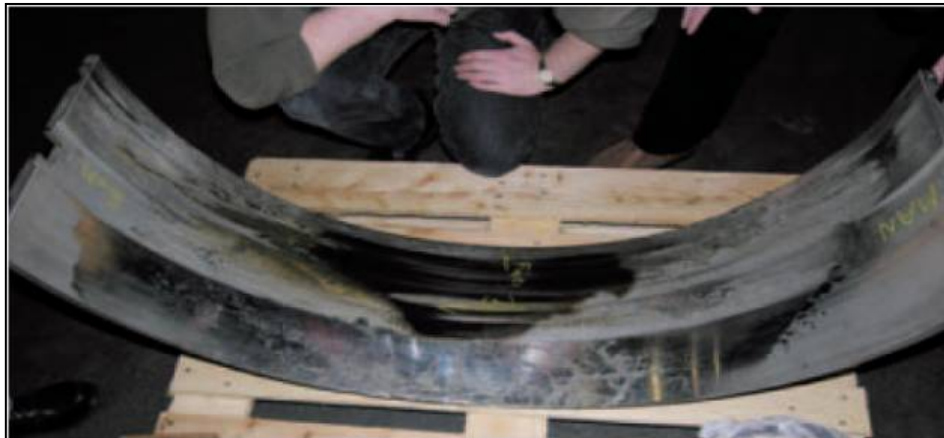

Fig. 11. Bearing liner with the marks of extensive wear [23]

Fig.12 displays the damage to the crank-pin, which bears the marks of corrosive wear. The reason of the damage is inadequate installation of the bearing causing extensive wear, low smear oil pressure and high temperature leading to bearing liner overheating.

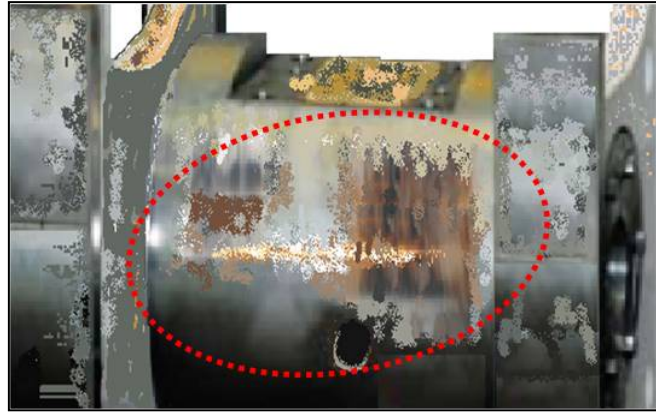

Fig. 12. Visible marks of corrosive wear caused by bearing overheating

Fig. 13 and 14 show damage to the engine crankshaft, which is at the place of joining of its elements.

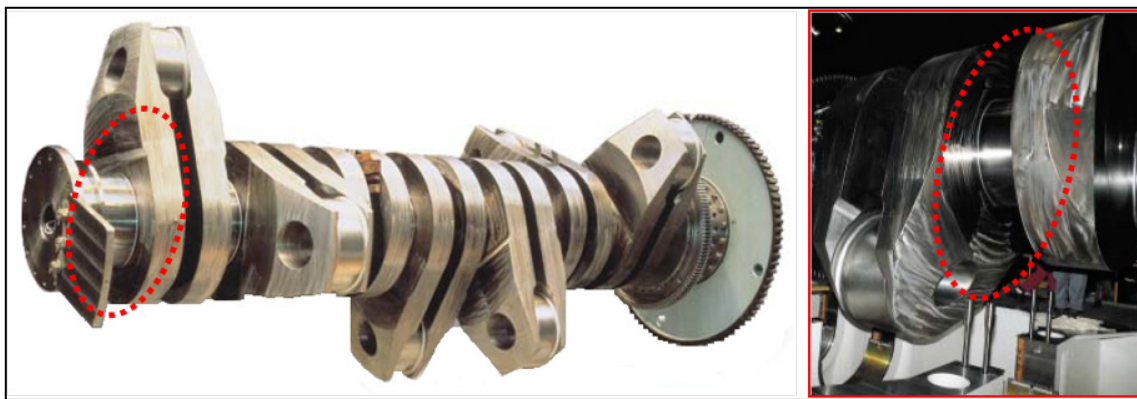

Fig. 13. Crankshaft with marked crank-pin [22]

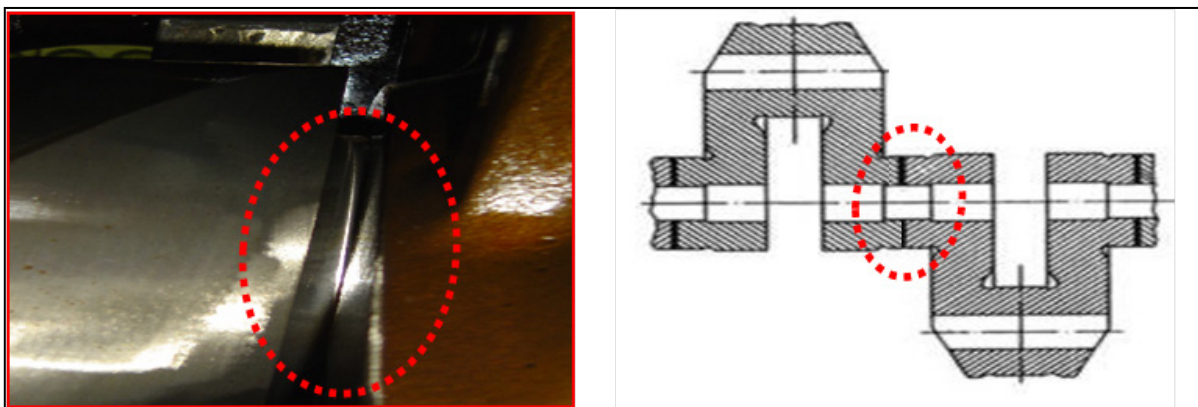

Fig. 14. Crack in the crankshaft at the joining of its elements [24]

Zone II (Fig. 14.), that is the zone, in which the dominating process is mechanical energy transmission, and tribological processes significantly influence the damage to the engine's tribological systems.

In the Fig. 15 one can notice the damage to the working surface with piston shank stuffing-box. The damage is the loss of material of the hardened face of the piston shank, local wear caused by

frictional corrosion and the occurrence of deep longitudinal scratches being the consequence of ridging and microslicing.

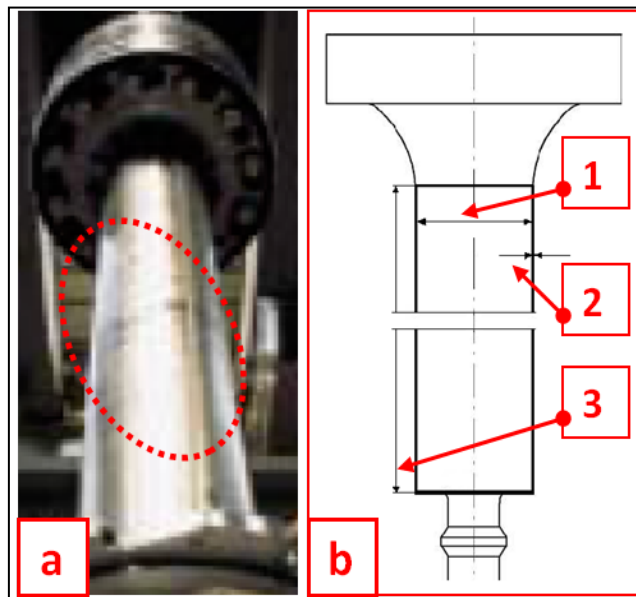

Fig. 15. The damage to the coating of the piston shank surface [12, 14, 22]; a) damaged surface, b) important dimensions: 1 - piston's diameter, 2 - thickness of the hardened coating, 3 - length of the hardened coating

The reasons of the damage are:

- excessive frictional wear caused by inadequate lubrication,
- frictional corrosion caused by water occurrence in the pressure charging and creation of water-oil emulsion, aggressive chemicals occurrence as effect of combustion (they get to the below-piston space during cold starting or due to poor condition of the piston-cylinder sleeve system),
- deep longitudinal scratches caused by particulate solids coming from damaged piston, sleeve or piston shank's stuffing-box elements or the piston shank itself.

Picture 16 displays the damage to the piston shank's stuffing-box. The damage is the wear in the process of engine use, leading to section ovality occurrence and mechanical damage to the casing elements and segmental elements of the skimming-tightening rings.

The reasons of the damage are:

- frictional wear, visualizing as uniform loss of material of the tightening rings caused by ring friction against the tightened surface of the piston's shank,
- DTR incompatible: "dry-running" of the piston's shank, crosshead bearing clearance, stuffing-box installation, contracting spring rupture, contamination of the tightening rings by the products of combustion leading to section ovality occurrence.
- installation errors (impurities of the elements, skew, ring assembly from different elements of the rings, "up-side-down" setup of the ring), corrosive damage, which may cause ring cracking [13],
- aggressive chemicals created during incomplete combustion in changing load, especially during maneuvers at the time which inadequate media parameters are kept or when the piston-cylinder system is damaged, which lead to corrosive damage of the casing and stuffing-box rings.

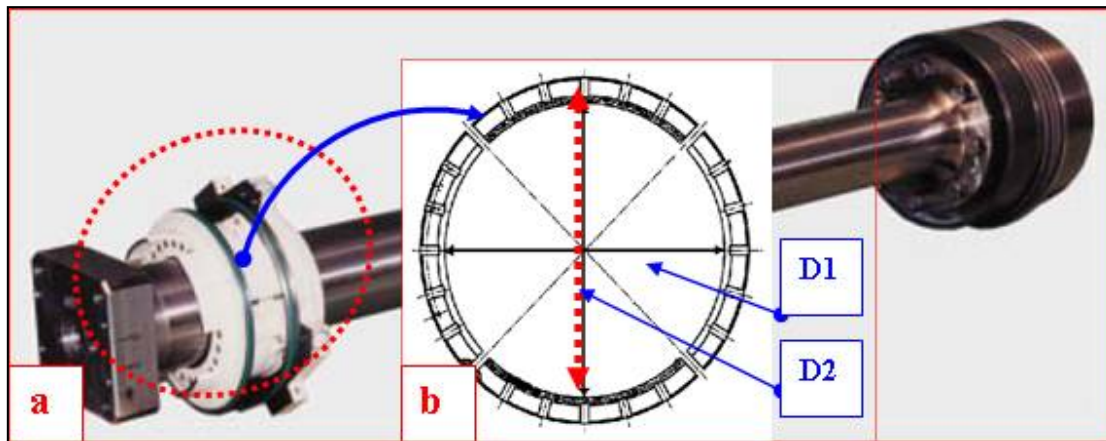

Fig. 16. Stuffing-box of the piston's shank [11, 13]: a) set on the shank [22], b) section ovality of the stuffing-box: D1 - allowable diameter, D2 - excessive wear diameter

Zone III (Fig. 17), that is the zone in which the main factor of damage are vibrations.

The damage and their causes in the zone will not be taken under consideration because they apply to the engine hull damage, such as cracks in the cross-corners of the welded joints of the engine's hull pillar, cracks of the welded joint of the main plate and ribbing plate, cracks of the ribbing plate between the technological holes, cracking of the resistance bearing column, etc. Some damage occurring in the zone influence the proper work of the main bearings. In example, the cracking of the column of the resistance bearing (being a part of the hull's pillar) (Fig. 17) may lead to main bearings' damage.

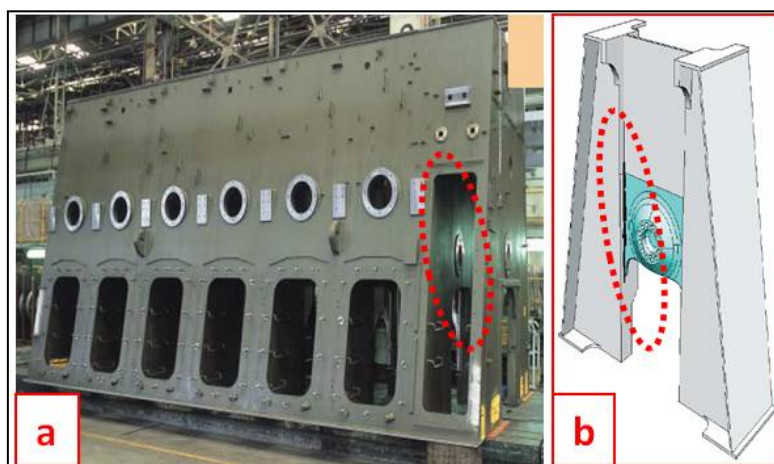

Fig. 17. Engine's hull pillar [23]: a) welded pillar multi-element construct , b) resistance bearing column

An example of resistance bearing crack along the fusion weld of the column and the main plate is described in the Fig. 18.

The reasons for such damage are:

- constructional factors - joining of two heavy column elements with light ribbed element constructions,
- installation factors - welding errors such as improperly prepared edges of the welded elements, bad weld penetration, improper joint face of the fusion weld.
- running factors - changing pressure caused by periodical fuel combustion, increase in vibrations caused by improper running of the light lateral elements, vibration dampeners, using of the shock methods of tightening on the resistive bolts fastening the main bearing.

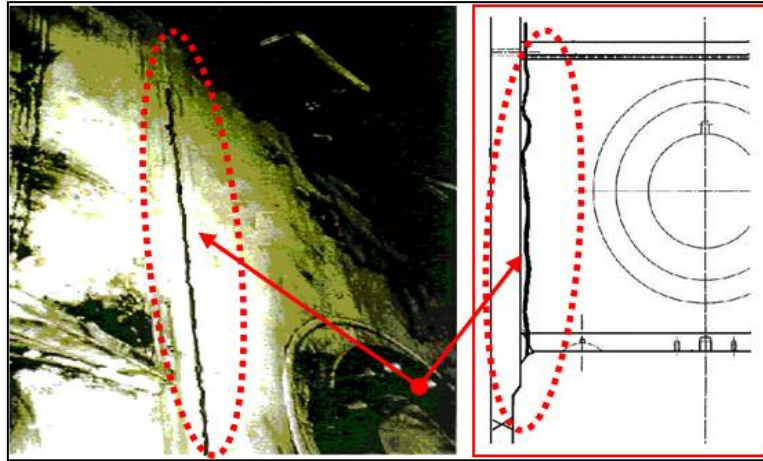

Fig. 18. Pillar of the engine's hull with a crack in the resistance bearing column along the fusion weld of the column and the main plate [10]

5. Analysis of the damage causes of the main tribological systems of the two-stroke, slow-running, high-power main engines

The research on the subject of wear and damage including the main tribological systems failure has shown many difficulties both in the aspect of gathering the data and its analysis. In most cases of the damage to the systems mentioned in the research, there is a break-down related maintenance documentation. However, there is no data on the causes of the damage, even the widespread ones - called "break-downs", rich source of photographic data is available, gathered within the private collections of mechanics and vast unpublished expert knowledge in collections of engine manufacturers, ship-owners, classification and insurance companies. The data is accessible only in cases of spectacular and media-advertised break-downs and is displayed in professional literature such as; Marine Chamber or Marine Board bulletins in expert approved versions. The paper shows and analyses given material made available by ship-owners, mechanics and unpublished bulletins of the engine manufacturers and classification companies. Described facts demonstrate the complexity of genesis of the damage to the tribological systems and its dependence of the randomly occurring factors and events, which can be divided in course of accepted criteria such as:

1. Constructional structure of the engine's tribological systems - complex of specific element shapes and sizes,
2. Geometric dimensions of the engine's tribological systems elements - dependent on the assumed power, planned period of load or type of work (i.e. dynamics of load change) of the engine, which are dependent on the ships assignment (main dimensions are the piston diameter, piston stroke, and related: size of the crankshaft curves and sizes of crank-pins and frame bearing liners and crank bearings),

Geometric shapes and dimensions of the piston shank and stuffing-box of the below-piston space are dependent on the amount of energy transmitted to the crankshaft.

3. Material structure - the main criteria here is (strictly related to the function of the tribological system elements) endurance and durability, i.e. piston's material structure: different head material, coating material, sieve wall material, piston ring material (covered with aluminum, chromium, and ceramic material).

The focus however should be on the strict hierarchic relation of the co-working elements in the tribological systems i.e. more durable (crankshaft) crank-pin (of high size, mass, difficult and time-consuming disassembly), faster wearing surface of the bearing (smaller size, mass, easy to disassemble, low material cost).

An important feature of material is the resistance to high temperature and aggressive chemical waste gas environment, especially of the pistons, their rings and cylinder sleeves (which make the combustor)

4. Physical and chemical phenomena - every identified damage occurring at the time of using of the engine's tribological systems is explained in accordance to scientific (and sometimes non-scientific) knowledge, and experience of the users and designers. Therefore, research explaining basic damage causes with the use of corresponding scientific methods would prove useful.

During practical use fields of pressure, temperature and stress are created. Their values are determined at the time of work in normal conditions, but maximal values and security coefficients are known. The values are verified during lab-trials (engine test house trials) in the manufactories and while engine using. The changes in the temperature, pressure and stress fields are dependent on the conditions of use, including the choice of proper preparation of used media (mainly fuel and smear oil). The quality of the process of combustion is related to the calorific value and physical properties of fuel. The chemical composition of the fuel and smear oil (i.e. sulfur or/and vanadium content) affects the damage by aggressive corrosive compounds.

5. Human factor - crew actions and other clerical employees of the ship-owner affect:

- the main two-stroke slow-running high-power engine adjustment as diagnostic systems (SDN), especially their tribological systems and diagnostic systems (SDG) used for diagnostics (the choice of sensors and data processing apparatus including its precision class),
 - the choice of the crew and its rotation (having influence on the quality of work of the crew and - so called by engine manufacturers - "emotional bonding between the machine and the man"),
 - the management of the spare parts and media (choice of manufacturers, and spare part sellers, media, shipping logistics and storage of the spare parts and media, the regularity in the media quality checkups)
 - the quality of maintenance, both damage-related and planned servicing called preventive (the choice of repair shipyard, ship's crew, inspecting services, servicing firms etc.)
6. External factors - the conditions specific for the water region, the weather - currents, waving (the length, steepness and height of the waves), rainfall (air humidity), frequency of occurrence, direction and force of the winds, water salinity (the amount of salt in the water-mist sucked in with the air).

In reality, every displayed factor influences the quality of use of the two-stroke slow-running main engines and their main tribological systems. Often accumulation of several different factors leads to extensive damage of engine's every main tribological system, thus the engine itself.

The described damage, including extensive ones (break-downs) were the caused by accumulation of several factors. It is important to have in mind that the faults in the constructional structure may not be disclosed during designer assumed (DTR) prophylactic maintenance of tribological systems. Whereas the accumulation of operational faults leads to short-time damage disclosure in their SDG.

An opposite situation occurs in cases when engine's structural construct is correct, and the errors are made and long unnoticed and the losses accumulate.

Picture 1 shows zones in which the main damage to tribological systems and their elements is caused by factors dominating in physical and chemical processes during energy processing and transmission. The factors are forces, stress, high temperature and aggressive chemical environment.

- the dominating process in zone I is combustion in the combustor, at the time which the most important factor is high temperature and aggressive chemical waste gas.
- in zone II the dominant is mechanical energy transmission, at the time which the most important factors are tribological processes.
- in zone III the dominating processes are vibrations.

After thorough analysis of engine failure, one can isolate such causes of the damage: structural errors, hidden defects, or structural material damage during heat treatment, improper assembly, incorrect using (engine abuse, unfit supervision etc.), bad choice and preparation of media/utilities (fuel and smear oil), improper mechanical processing, insufficient filtering, spinning, homogenizing, lack of supervision and bad chemical processing of energy factors (fuel composition, smear oils, cooling water), inadequate values of thermal parameters (too high or too low temperature of diesel fuel and smear fuel, improper temperature of cooling water cooling the pistons, sleeves, headings, escape valves etc.), lack of supervision and time exceeding between all maintenance.

6. Commentary and Conclusion

Although, diagnostic systems (SDG) are implemented to diagnose the engine running; during the use of two-stroke, slow-running high-power main engines one can distinguish several different damage of their tribological systems. SDG's are more and more computerized because engine manufacturers want to improve and implement SDG to engine use. An example of such action is the use of CoCoS systems (Computer Controlled Surveillance System) in the MAN B&W Diesel Group manufactured engines.

The use of such systems however, cannot prevent the damage. One of main causes of damage occurrence is the random attribute of thermal and mechanical load of such engines and in consequence - wear. Such damage to the tribological systems is unpredictable by its randomness but can only be estimated in terms of probability of occurrence in the process of use.

The load values of the tribological systems of the two-stroke, slow-running, high power main engines and their relation to mentioned system wear have been explained in forms of two hypotheses: the first clarifies the relation between the mechanical load $Q_M(t)$ and thermal load $Q_C(t)$ of the engines, and the other- the existence of stochastic linear relation in which the value of correlation coefficient $R_{qz}=1$.

References

- [1] Brun R.: Szybkobieżne silniki wysokoprężne. WKiŁ, Warszawa 1973. Dane o oryginale: Science et Technique du Moteur Diesel Industriel et de Transport. Copyright by Societe des Editions Technip et Institut Francais du Petrole, Paris 1967.(2).
- [2] Girtler J.: Issue of changes in technical states of a diesel engine as the result of wear of its tribological systems. Zeszyty Naukowe Akademii Morskiej w Szczecinie, 31 (103), 2012., s. 77-82.(OMUP).
- [3] Girtler J., Kuzmider S., Plewiński L.: Wybrane zagadnienia eksploatacji statków morskich w aspekcie bezpieczeństwa żeglugi. Monografia. WSM, Szczecin 2003.
- [4] Girtler J.: Necessity for and possibility of application of the theory of semi-Markov processes to determine reliability of diagnosing systems. Journal of POLISH CIMAC. - Vol. 7, No. 2 (2012), s. 45-54.
- [5] Girtler J.: The semi-Markov model of energy state changes of the main marine internal combustion engine and method for evaluating its operation during ships voyage // Polish Maritime Research. - Vol. 18, nr 4, 2011, s. 36-42.
- [6] Piotrowski I.: Okrętowe silniki spalinowe. WM, Gdańsk 1971.(15).
- [7] Piotrowski I., Witkowski K.: Eksploatacja okrętowych silników spalinowych. AM, Gdynia 2002.(16)
- [8] Wajand J.A., Wajand J.T.: Tłokowe silniki spalinowe średnio- i szybkoobrotowe. WNT, Warszawa 2005.(21).

- [9] Włodarski J.K.: Tłokowe silniki spalinowe. Procesy tribologiczne. WKiŁ, Warszawa 1981.(22)
- [10] Cracks in Column, Service Bulletin No RTA-46. Wartsila NSD Corporation Ltd, Winterthur 1999.(12).
- [11] Piston Rod Gland Package. Wartsila Corporation, Waasa 2004.(64).
- [12] Reconditioning of Piston Rods RTA-“8 Series” Engines. Service Bulletin No RTA-37.1, Wartsila NSD Corporation, Winterthur, 2001.(72)
- [13] Retrofit for Piston Rod Stuffing Boxes RTA”-2 and 2U Series” Engines. Service Bulletin No RTA-35.1, Wartsila NSD Corporation, Winterthur, 2001.(73)
- [14] Running-in of Cylinder Liner and piston Rings. Service Bulletin No RTA-18.1, Wartsila NSD Corporation, Winterthur, 1998.(82)
- [15] Running-in of Cylinder Liner and piston Rings. Service Bulletin No RTA-18.2, Wartsila NSD Corporation, Winterthur, 2002.(83)
- [16] S 80ME-C Project Guide Electronically Controlled Two-stroke Engines. MAN B&W, Kopenhaga 2002.(84)
- [17] RTA 58/68/76/84 Cracks on Piston Skirts Type Engines. Sulzer Information Bulletin No DUQ1-008E, Diesel United Sulzer, 1991.(75)
- [18] RTA 58/68/76/84 Checks of elastic studs on piston for tightening. Service Information Bulletin No DUQ1-009E, Diesel United Sulzer, 1991.(76)
- [19] RTA Engine, Corrosive Burn-Off Pocket on Cylinder Cover. Service Information Bulletin No DUQ1-017E, Diesel United Sulzer, 1990.(77)
- [20] RTA Engine, Corrosion in exhaust gas passage of exhaust valve cage. Service Information Bulletin No DUQ1-016E, Diesel United Sulzer, 2003.(81)
- [21] Sulzer RTA Engines, RTA 2–2U Series, Piston Crowns Loss of Material on Combustion Side. Service Bulletin no RTA-38, Wartsila NSD Corporation, Winterthur, 1998.(95)
- [22] Sulzer RT-flex 60C, Wartsila Corporation, Helsinki 2004.(96)
- [23] Transportation Safety Board of Canada. Marine Investigation Report M00L0034, Main Engine fires, 2001.(104)
- [24] Transportation Safety Board of Canada. Marine Investigation Report M00L0034, Main Engine Failure, 2000.(105)
- [25] Warsash Maritime Centre. The Learning Resource for Maine Engineers, Southampton Solent University, Southampton 2005.(107).
- [26] RTA Type Engines, Characteristics of Cylinder Liner and Piston Ring Wear. Service Information Bulletin No DUQ1-02E, Diesel United Sulzer, 1991.
- [27] Sprawozdanie z realizacji etapu projektu badawczego własnego pt. „Analiza własności modelu diagnostycznego układów korbowo-tłokowych silników przysposobionego do potrzeb racjonalnego sterowania procesem eksploatacji tych silników w aspekcie bezpieczeństwa statków oraz morskiego środowiska naturalnego” zrealizowanego w ramach projektu badawczego własnego finansowanego przez MNiSW Nr N N509 494638 pt.: „*Decyzyjne sterowanie procesem eksploatacji układów korbowo-tłokowych silników napędu głównego statków morskich z zastosowaniem diagnostyki technicznej oraz uwzględnieniem bezpieczeństwa i ochrony środowiska*”. Autorzy sprawozdania: Girtler J., Łosiewicz Z. Prace badawcze nr 06/10 /PB. Wydział Oceanotechniki i Okrętownictwa Politechniki Gdańskiej, Gdańsk 2010.