



Volume 122

2024

p-ISSN: 0209-3324

e-ISSN: 2450-1549

DOI: <https://doi.org/10.20858/sjsutst.2024.122.6>



Journal homepage: <http://sjsutst.polsl.pl>

Article citation information:

Iwanowicz, D. Traffic control at pedestrian priority crossings with guaranteed lane throughput capacity as exemplified by the legal regulations applicable in Poland. *Scientific Journal of Silesian University of Technology. Series Transport*. 2024, **122**, 85-109. ISSN: 0209-3324. DOI: <https://doi.org/10.20858/sjsutst.2024.122.6>.

Damian IWANOWICZ¹

**TRAFFIC CONTROL AT PEDESTRIAN PRIORITY CROSSINGS WITH
GUARANTEED LANE THROUGHPUT CAPACITY AS EXEMPLIFIED BY THE
LEGAL REGULATIONS APPLICABLE IN POLAND**

Summary. The article describes the problem of excessive traffic concentration at signalized pedestrian crossings. The main drawback of such crossings is the inappropriate duration of green signals for vehicles. Too long green times for vehicular traffic significantly increase time lost by pedestrians, while too short ones cause short-term congestion, resulting in long queues of vehicles and a deteriorated level of service. The negative effects of both of these situations also include dangerous behavior of road users, such as red light running or crossing. Recent (June 2021) changes in the road traffic law in Poland have privileged unprotected road users at pedestrian crossings. New models and technical and design standards proposed in this country (March 2021) recommend the installation of pedestrian priority crossings at particularly dangerous spots and in urban areas with a high proportion of pedestrian traffic. All this is done mainly for traffic-calming purposes. However, previously these measures were not a common practice in Poland. Therefore, the objective of this article was to develop a simple method of green signal timing, ensuring, firstly, priority to pedestrian traffic at such places, and, secondly, sustained capacity of vehicular traffic lanes. The developed models are practical, universal and easy to adapt in other countries. They ensure a very good or good quality of vehicle traffic service, with average lost time not exceeding 25 s

¹ Faculty of Civil and Environmental Engineering and Architecture, Bydgoszcz University of Science and Technology, Al. Prof. S. Kaliskiego 7 Street, 85-796 Bydgoszcz, Poland. Email: damian.iwanowicz@pbs.edu.pl. ORCID: <https://orcid.org/0000-0001-5687-6341>

in a vast majority of analyzed traffic level cases. The article also describes a traffic control algorithm dependent on traffic detection.

Keywords: pedestrian, traffic signal control, pedestrian priority crossing

1. INTRODUCTION

Recent changes in road legislation in Poland [1] have resulted in considerable privileging of pedestrian traffic at pedestrian crossings to achieve road traffic-calming and to increase safety for pedestrians. Vehicle drivers approaching pedestrian crossings must give way to pedestrians who are already on the crossing or entering it (this does not apply to trams). Therefore, Poland has finally implemented the key provision of the Vienna Convention concerning the behavior of vehicle drivers on the approach to pedestrian crossings [2]. Naturally, this provision applies to crossings which are not controlled by traffic signals. On the other hand, in many places with a big proportion of pedestrian traffic situated close to major traffic generating facilities and with heavy vehicular traffic, traffic signals will still be in use. This is dictated by high levels of risk in the road traffic, determined by the probability of a “meeting” between a motorized and pedestrian road user at the conflict point. Additionally, Poland is a country with a very high percentage of road accidents involving pedestrians at pedestrian crossings and, unfortunately, with a large number of casualties killed and seriously injured at these sensitive locations [34]. Recognition of this problem was presented, among others, in [40], which shows that ~27% of fatalities are pedestrians. In a slightly broader aspect, pedestrian safety has also been characterized on urban roads [13, 14, 41]. The analysis of data on fatalities in the context of pedestrians presented in this paper is also disturbing.

As one can read in the new models and technical standards recommended by the Minister responsible for transport [33], installation of traffic lights is to be the recommended solution in such places, and it is going to be mandatory on two-way roads and dual carriageway two-lane streets. It should also be noted, that traffic signal systems recommended in this respect are the pre-timed signals which give priority to pedestrians over vehicular traffic in such a way that the actuated state of the traffic phase is to apply to vehicles approaching the pedestrian crossing. However, the problem is that currently this is a very rare design and implementation practice. It is customary to design traffic lights only for the demand for vehicle traffic. One could say that in Polish conditions it can be even considered innovative.

Taking the above into consideration, the author synthetically describes the problem of the traffic carrying capacity of such elements of the road network with the assumption that the minimum (required by law) green times are set in the signaling program or in the event of the traffic detection system failure and subsequent triggering of the permanent actuation state for such short periods of green interval duration. Based on analyses, it was proposed to use the so-called "set green signal duration" for vehicle drivers as a function of the expected design hourly traffic volume and in association with the set cycle length.

An optimum duration of the green signal for pedestrians, and hence one cycle length, were also estimated. This solution allows, firstly, to keep the priority for pedestrians during the signal operation period, and secondly, it secures the critical saturated and supersaturated vehicle traffic conditions, sustaining for a lengthy period of time, e.g. at the traffic peak. Thanks to this solution, users of such an element of infrastructure will not experience significant delays, which will translate into less impatience, stress and situations in which they fail to yield the right of way, or breach the law otherwise e.g. by red signal running or crossing.

The analyses also covered the verification of the longest possible durations of signals shown to pedestrians along with the recommended durations of green signals for vehicles in order to sustain the appropriate level of service (LOS) for the control strategy aimed at traffic-calming.

The practical method of selecting the duration of the green signal at such sites appears to be very useful for traffic engineers and traffic signal designers due to the innovative approach in the traffic control method, which previously was not used in Poland on a large scale. With appropriate adaptation of the variables used in the calculations, this method can be utilized in practically every country.

2. LITERATURE REVIEW

The problem of pedestrian traffic control is not very widely researched and is rather based on many simplifications and rules defining the traffic control program, which results from the transport needs of car drivers. The entire theory of traffic controlled by traffic lights is based on the groundbreaking work [49], which characterizes the method of assigning the dose of green signals depending on the intensity of saturation for a given length of the signaling cycle, which results from the lost time for service (inter-green time). This method was then very well recognized in the world, constituting the basis for further analyzes and development of, among others, in the works of [3, 4, 29]. These studies are still being updated to this day, an example of which is the work [44].

The specificity of the traffic control program on sections between intersections has been provided with a two-phase rule, for which traffic is allowed in each phase either for vehicles or for pedestrians. The characteristics of this specificity have been presented in work [27]. The problem of optimizing the operation of traffic lights in the field of pedestrian traffic control for reducing time loss and selecting the length of the green signal interval is described in [37]. Pedestrian movement detection research was described, among others, in manuscripts [11, 22]. On the other hand, studies on the safety of traffic controlled by light signals in the context of pedestrians have been described, among others, in papers [24, 51, 52], which clearly show that the biggest problem for pedestrians is entering the road during the red signal.

3. THE PROBLEM OF INAPPROPRIATE SIGNAL TIMING

Traffic control at pedestrian crossings on the links (beyond intersections) in the vast majority of cases in Poland is programmed for operation with the pre-timed (fixed) green signal for vehicles, with actuation for pedestrians (after they have been "captured" by the detection system). Controllers for such traffic signal systems operate according to the following control scheme assumed in the signaling program.

$$\textit{fixed} \rightarrow \textit{actuated} \rightarrow \textit{fixed} \quad (1)$$

In the fixed state, the green signal G_{veh} is shown to vehicles and the red signal R_{ped} is shown to pedestrians. In the actuated state, the situation is reversed and the red signal R_{veh} is shown to vehicles, while the green signal G_{ped} is shown to pedestrians. These two phases are divided by the so-called intergreen period t_{mg} . It is the time ensuring safe transition from the pre-timed state into the actuated state and vice versa. During this time, the sequence of the displayed signals changes [35]:

- for vehicular traffic: from the pre-timed state into the steady amber signal and next into the red signal in the actuated state and from the pre-timed state during the red signal into the red and yellow signals jointly and then into the green signal in the pre-timed state;
- for pedestrian traffic: from the pre-timed state into the green signal in the actuated state and from the actuated state into the flashing green signal and further into the red signal in the pre-timed state.

In traffic control at pedestrian crossings, we have to do with two intergreen times, taking into account the clearance from the area of conflict between the intersecting traffic streams:

- of vehicles $t_{mg,veh}$, when their green time comes to an end,
- of pedestrians $t_{mg,ped}$, when their flashing green time comes to an end.

The sequences of signals shown by traffic lights to drivers and pedestrians are presented in Figure 1.

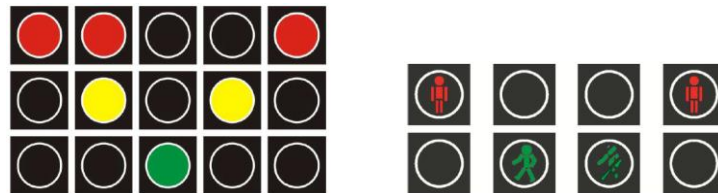

Fig. 1. Vehicular and pedestrian traffic signal sequences displayed in Poland [35, 36]

For many years, practically all such signalized pedestrian crossings in the Kuyavian-Pomeranian Voivodeship had this type of traffic control [38, 40]. Only in 2021 the first traffic signal system, which considers the speed of approaching vehicles, will be installed at the pedestrian crossing situated on a link in Bydgoszcz (the major city in the province). When an approaching vehicle exceeds the set speed limit value (55 km/h), the traffic signal will turn red for vehicles, even if there is no demand for pedestrian service. However, it is still a traffic signal system with the actuated state for pedestrian traffic. This kind of traffic control is also in use in cities such as Lodz, Cracow, Warsaw, Gdansk or Poznan [5÷10].

In recent years, more complex traffic control systems have been put into use at pedestrian crossings (outside of intersections) in municipals road network. Most of them are area control systems controlling arterial coordination. However, in isolated traffic signal systems, designers and traffic management agencies tend to introduce traffic lights with the so-called 'all red' scenario. It is a case the red signal is displayed continuously in the fixed phase. When traffic detection is actuated, whether by a pedestrian or by a vehicle, the traffic signal switches into the actuated state, calling the appropriate phase. Such traffic signals can also have an algorithm for calling the signaling phase for vehicles when analyzing the speed of the vehicles approaching the crossing. If the set speed limit is exceeded, the system will force vehicle drivers to stop at the crossing even if there are no pedestrians on it. Currently, this mode of control poses the greatest problem when traffic consists of very loosely spread groups of vehicles with the assumed minimum green signal duration for vehicles, which during off-peak periods and, above all, in the evening hours, leads to an increased number of red signal entries and sudden braking manoeuvres. These situations occur especially on through roads and streets or on the collector-distributor city trunks [15-17, 20, 23, 31, 32, 39, 45, 48, 51].

Both of the above-described methods of traffic control have one thing in common. They function as a sort of traffic-calming method. They should also be combined with the innovative in Poland approach to traffic control, based on vehicle demands, when the pre-timed state

involves showing of green signals to pedestrians and red signals to vehicles. This solution was employed, for instance, in Lodz, Poznan, or Gdansk, resulting in the subsequent findings [46, 47]

- vehicle speed was reduced on the road section within the pedestrian crossing influence area,
- pedestrian delays were reduced,
- the number of vehicle stops was reduced,
- high social acceptance of the scheme was achieved.

A relatively high cost of this solution, both at the implementation stage and later during the operating life is its indicated drawback. This solution is still operating in Gdansk, with design hourly traffic volumes Q_{veh} of 350 veh/h and pedestrian traffic volumes Q_{ped} of up to 3000 ps/h.

The inadequacy of green signals for vehicles and incorrect control algorithms frequently results in the obstruction of vehicular traffic at pedestrian crossings. The traffic signals operating in the village of Przysiek in the Kuyavian-Pomeranian Voivodeship can be given as an example here. This traffic signal helps pedestrians get to and from public transportation stops at the intersection of Bydgoszcz and Toruń. During peak hour periods, high demand for pedestrian and car traffic causes major vehicular traffic congestion at this location. This is caused by insufficient green time for vehicles set in the control program with "constant" actuation of the pedestrian phase. This results in massive delays for drivers and significant vehicle queues (propagating upstream up to the neighboring village and further). Similar situations can be observed at many pedestrian crossings in the vicinity of major traffic generating facilities, such as schools and shopping centres, for example in cities such as Bydgoszcz and Toruń. On the contrary, we are addressing situations where the duration of the green signal displayed for vehicular traffic is excessively prolonged during off-peak hours, resulting in pedestrians who are preparing for service (for the actuated phase) being held back for the entire duration of the green interval intended for vehicles (including intergreen times), resulting in delays during their travel, even during periods of low traffic flow. These situations occur most often on housing estates or in the centres of big and medium-sized cities [39]. They usually stem, firstly, from design errors as regards the assumed traffic control parameters (inappropriate duration of green intervals) and secondly from current vehicle traffic service at peak traffic periods in developed areas, where the vehicle throughput is ensured in the first place, and only after it has been determined the duration of the green signal for pedestrians is specified.

4. ANALYSES FOR A TYPICAL PEDESTRIAN CROSSING CASE

In accordance with Polish regulations, a "virtual" full-scale testing facility was designed, representing a typical signalized pedestrian crossing. A schematic view of this crossing is shown in Fig. 2 below. The following table compiles all geometrical and traffic management parameters of the pedestrian crossing under analysis.

Two signal groups for vehicle drivers ($1K$ and $2K$) and one signal group for pedestrians ($3P$) were distinguished. These groups are controlled, respectively, by traffic signals: $k1$, $k2$ and $p3a$, $p3b$. Manual (push-button) detectors for pedestrians $Dp1$ and $Dp2$ were used as standard in actuated control. Some traffic control applications (e.g. "all-red" control) also use vehicle detectors plotted as $Da1$ and $Db1$ in the diagram.

The analyses assume the scenario of actuated control at the maximum traffic level for one hour ($t_a = 1$ h). In the fixed time traffic signal operation (without traffic detection) this means allocation of the green signal duration to vehicles or pedestrians, timed in line with the program designer's idea. In the actuated variable time traffic signal operation, this additionally involves taking account of possible engagement of vehicle detectors and extending the green time to the maximum value – also determined by the designer. In Poland, maximum green times are not arbitrary and are specified only by designers based on traffic level analyses (if performed). On the other hand, the minimum durations of signals allowing traffic to proceed G_{min} are specified by the law and are as follows [35]:

- for vehicles $G_{min.veh}$:
 - in the fixed time traffic signal operation, the minimum green time is 8 s,
 - in the variable time traffic signal operation, the minimum green time is 5 s,
- for pedestrians:
 - the green signal interval $G_{min.ped}$ is equal to the period needed to walk across the entire length of the crossing with the speed of 1.4 m/s, but no less than 4 s,
 - the flashing green signal interval G_{mig} is 4 s (during which pedestrians are also allowed to enter the crossing, provided they have to clear it as soon as possible).

In the calculations, the author assumed the worst possible scenario, i.e. the shortest green signal duration.

Tab. 1
Geometrical and traffic management parameters of
the simulated traffic control situation

Parameter	Value
Traffic lane width	3.0 m
Pedestrian crossing length	6.0 m
Pedestrian crossing width	4.0 m
Vehicle speed limit	8.3 m/s
Pedestrian crossing speed	1.4 m/s
Distance between the vehicle stop line and the edge of the crosswalk	2.5 m

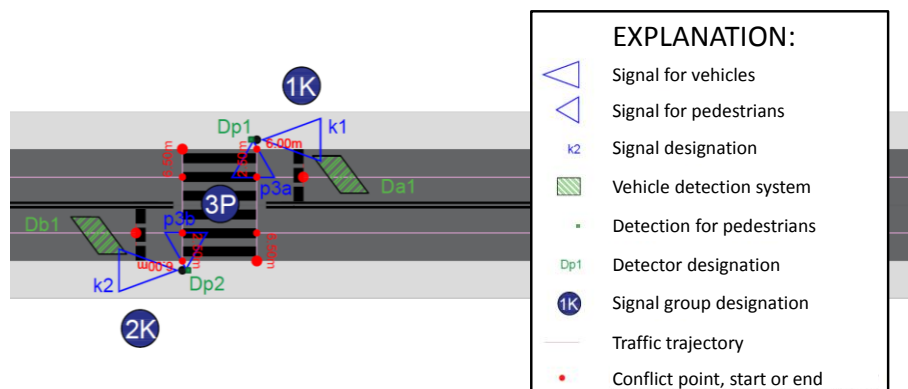

Fig. 2. Schematic view of the testing facility representing a typical pedestrian crossing

Intergreen times were calculated based on the relevant Polish regulations [35]:

$$t_{mg} \geq t_{mg.calc}, \quad [s] \quad (2)$$

$$t_{mg.calc} = \lceil t_Y + t_e - t_d \rceil \geq 0, \quad [s] \quad (3)$$

with:

$$t_e = \frac{s_e + l_{veh}}{v_e}, \quad [s] \quad (4)$$

$$t_d = \frac{s_d}{v_d} + 1, \quad [s] \quad (5)$$

where t_{mg} is the assumed final value of the intergreen time in the traffic control program (s), $t_{mg.calc}$ is intergreen time for a pair of road users, ensuring safe exit of a road user from the area of conflict with another road user who will be given permission to go as next and will be moving into this conflict area (s), t_Y is duration of amber time (in Poland this is a fixed value of 3 s), t_e is the time during which the road user clears the conflict point (after the elapsed time allowed for movement), measured starting from the vehicle stop line or from the edge of the carriageway (s), s_e is clearance distance (m), l_{veh} is an average length of the vehicle extending the clearance distance (m), v_e is clearance speed (m/s), t_d is time of approach of the road user to the point of conflict with another road user clearing the point, measured starting from the vehicle stop line to the conflict point (s) – for pedestrians 0 value is assumed arbitrarily, s_d is length of approach to the conflict point (m), v_d is speed of arrival at the point of conflict (m/s) and $\lceil \rceil$ is the symbol of rounding up to the nearest integer.

Geometrical data given in Table 1 were taken for analysis. Additionally, for safety reasons, the calculated values of intergreen times $t_{mg.calc}$ for the vehicles clearing the crossing were extended by additional 2 s, and for the pedestrians clearing the area - by additional 3 s. Hence, the final assumed values of intergreen times t_{mg} :

- for the vehicles clearing the crossing:

-

$$t_{mg.veh} = 7 \quad s \quad (6)$$

- for pedestrians clearing the crossing:

$$t_{mg.ped} = 6 \quad s \quad (7)$$

As a result, two traffic signal programs were obtained serving pedestrians and vehicles which maintain the minimum green times for both signal groups (road users) – see Figs. 3 and 4. Thus, the assumptions above represent the worst possible traffic control scenario, involving constant phase actuation and, of course, a situation of the detection system failure. The emergency program ensures service for all road users over the period of one cycle for the set light signal durations.

In the analyses of traffic conditions for the signaling programs designed in this manner, the author used the capacity and traffic service calculation method recommended for application in Poland [43]. The method was adapted based on [16, 19] and other manuals. It demonstrates no significant differences in the results of the estimated road traffic conditions (level of service) for these methods [26, 38]. For the assumptions prepared in this manner with green signal durations, the results of vehicular traffic capacity calculations are as follows:

- for the fixed time traffic signal operations, the traffic lane capacity C is 540 pcu/h, with the signaling cycle duration T of 30 s,
 - for the variable period traffic signal operations, the traffic lane capacity C is 400 pcu/h, with the signaling cycle duration T of 27 s,
- where C is traffic lane capacity:

$$C = S \cdot \frac{G_e}{T}, \quad [pcu/h] \tag{8}$$

where S is saturation flow rate (pcu/h) – for traffic conditions under analysis (Table 1): $S = 1800$ pcu/h/lane, T is a cycle length (s) and G_e is the duration of the effective green signal (s) – under Polish conditions the standard assumption is:

$$G_e = G_{veh} + t_y - 2, \quad [s] \tag{9}$$

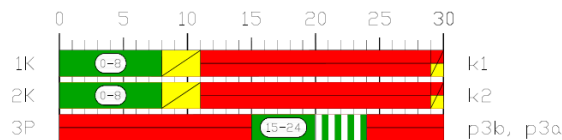

Fig. 3. Fixed time program for the assumed traffic control scheme

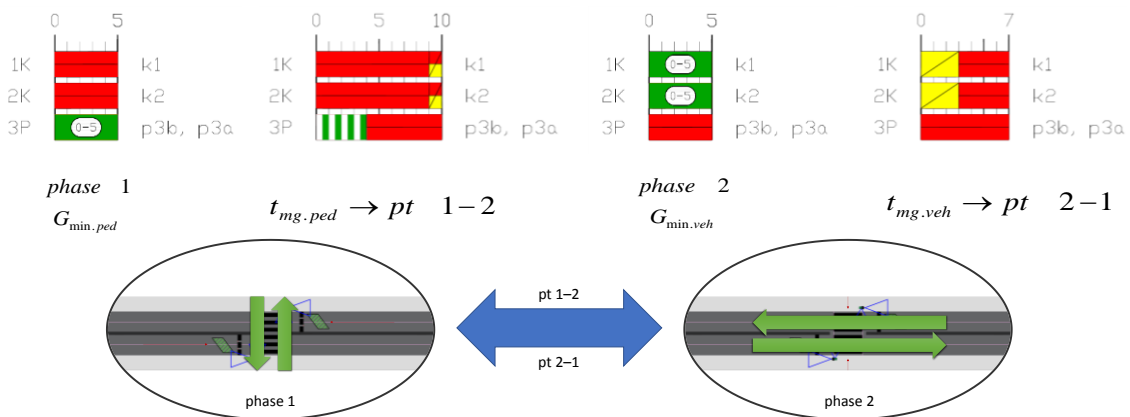

Fig. 4. Variable time program for the assumed traffic control scheme with minimum green time values

The calculations were made for the assumed vehicle traffic volumes Q_{veh} (without taking account of the traffic composition) within the 50 to 700 pcu/h/lane range with an analysis interval of 50 pcu/h/lane. Therefore, this representation will be aimed at showing the situation of maximum traffic level, as if on average within 1 minute, one passenger car approached the

analyzed pedestrian crossing every 5 seconds on a given traffic lane. As a result, it will be possible to determine the moment for which the minimum green intervals for the vehicles $G_{min.veh}$ turn out to be insufficient to ensure the proper level of service (LOS). The calculation results are given in Table 2.

As can be seen from the results of the calculations given in Table 2 above, assuming fixed time or emergency (continuous actuation) control for the minimum green times, this type of traffic control will not perform satisfactorily when the traffic volume Q_{veh} exceeds 450 pcu/h/lane. In the case of variable time traffic control (again with continuous actuation), this will happen when the traffic volume Q_{veh} exceeds 350 pcu/h/lane. Hence, it is clear that after exceeding of the abovementioned Q_{veh} values, vehicle traffic control becomes burdensome and dramatically increases the time lost during travel.

At this point, one should note an obvious fact, that it is important to time the light signals correctly to ensure performance of traffic control in terms of capacity C . The maximum traffic volume conditions, which persist for most of the traffic peak periods, are not a common phenomenon after all. Still, they can occur, just like a detection system failure, which can impact the traffic economy over the entire day. Hence, such a great importance of proper timing of green signals G_{veh} for vehicular traffic allowing to secure the capacity of the pedestrian crossing's cross-section and at the same time to avoid pedestrian and driver delays by determining the appropriate green signal duration and the length of the entire cycle T .

Tab. 2

Results of calculation of the measures of vehicle traffic service for the simulated traffic control situation

Analysis interval i	Vehicle inflow Q_{veh}	Results of calculation of basic measures of vehicle traffic service:							
		Fixed time traffic control				Variable time traffic control			
		Volume to capacity ratio [-]	Average lost time [s]	Average length of max. queue [veh.]	Average queue reach [m]	Volume to capacity ratio [-]	Average lost time [s]	Average length of max. queue [veh.]	Average queue reach [m]
1	50	0.09	7.59	3	6.2	0.13	8.47	3	6.2
2	100	0.19	7.91	3	6.2	0.25	8.98	3	6.2
3	150	0.28	8.33	5	12.4	0.38	9.79	5	12.4
4	200	0.37	8.90	5	12.4	0.50	11.15	5	12.4
5	250	0.46	9.70	5	12.4	0.63	13.56	7	18.6
6	300	0.56	10.84	7	18.6	0.75	18.49	9	24.8
7	350	0.65	12.59	9	24.8	0.88	32.11	11	31.0
8	400	0.74	15.54	9	24.8	1.00	94.69	23	80.6
9	450	0.83	21.50	13	37.2	1.13	270.06	54	204.6
10	500	0.93	38.09	17	55.8	1.25	483.89	92	353.4
11	550	1.02	102.82	32	117.8	1.38	704.80	132	508.4
12	600	1.11	238.88	65	248.0	1.50	927.88	173	669.6
13	650	1.20	396.86	103	396.8	1.63	1151.90	213	824.6
14	700	1.30	559.89	145	558.0	1.75	1376.39	255	985.8

Colour designations according to [30]: green – LOS I (very good traffic conditions up to 20 s/pcu), yellow – LOS II (good up to 45 s/pcu), orange – LOS III (acceptable up to 80 s/pcu), red – LOS IV (unacceptable exceeding 80 s/pcu).

5. THE SET GREEN SIGNAL PROPOSAL

5.1. The idea of determining the set green signal for vehicles

Targeted traffic control analyses were carried out to secure both the motor traffic capacity and the privileged position of the unprotected road users. The main goal was to select such durations of the traffic signals that an average traffic engineer could successfully apply the developed methods of their timing in typical road cross-sections. Therefore, it was a key factor to determine the appropriate durations of the signals which permit vehicles to proceed, and ensure, firstly, small delays for pedestrians (and give them priority at times of low traffic flow) and, secondly, the sufficient traffic capacity of this element of the road network plus a good quality level of service.

Keeping in mind the type of traffic control (fixed time or variable time operation) it was assumed that the minimum time of pedestrian service and, of course, intergreen times t_{mg} should not change during the period of constant actuation of demands by vehicles. Hence, the sum of the duration of the signal without permission to vehicles to proceed will be 22 s, which includes:

- the intergreen time for vehicle clearance (including 3 s of amber time): $t_{mg,veh} = 7$ s,
- the minimum green time for pedestrians: $G_{min,ped} = 5$ s,
- the flashing green time for pedestrians: $G_{mig} = 4$ s,
- the intergreen time for pedestrian clearance (including 3 s of amber time); $t_{mg,ped} = 6$ s.

With this knowledge in hand, the author commenced the analysis of the duration of the green "set" signal $G_{set,veh}$ for the assumed number of vehicles approaching the pedestrian crossing on a given traffic lane. The variable time traffic control with minimum duration of the green signal $G_{min,veh}$ of 5 s (as specified in Polish regulations [7]) was the starting point of the analysis. Hence, the length of a single full signaling cycle T (with continuous demand) will be:

$$T = G_{min,veh} + t_{mg,veh} + G_{min,ped} + t_{mg,ped} = 27, \quad [s] \quad (10)$$

Obviously, the above equation (10) is highly versatile in terms of application due to the legal and technical conditions in a given country (regarding the duration of minimum signals and the procedure for the determining intergreen times).

Analyzing numerous works on saturation flows [12, 25, 31, 50] and own studies [21], including in particular studies carried out in various weather conditions and at pedestrian crossings outside the area of influence of intersections, the author assumed a fixed time of service of one vehicle during the green phase of:

$$t_{serv} = 2.5, \quad [s / pcu] \quad (11)$$

This value takes into account the average share of heavy vehicles (buses) at the level of ~10% of the traffic flow in the traffic peak in traffic-calmed zones [21, 31, 32]. Therefore, the above time will be a determinant of the time of service of vehicles gathering at the pedestrian crossing during their red phase R_{veh} . In order not to complicate the calculations, it is assumed for further analyses that the sought for number of vehicles to be served at green phase will be the vehicles gathering at the crossing during a single signaling cycle T . In this way, some "spare" time is foreseen for serving vehicles from the traffic inflow different from orderly in character (with a fixed value of time interval).

In the next step of the analysis, the interval of vehicle traffic volumes Q_{veh} expressed in pcu/h (see Table 2) was assumed. The product of the vehicle traffic volume q_{veh} in pcu/s and the cycle length T , reflects a situation with which we will have to do "statistically on average" under the traffic flow within the period of an average signaling cycle T . For the exemplary traffic volume $Q_{veh} = 350$ pcu/h we will obtain:

$$LP = \left\lceil \frac{Q_{veh}}{3600} \cdot T \right\rceil = \left\lceil \frac{350}{3600} \cdot 27 \right\rceil = \lceil 2.625 \rceil = 3, \quad [pcu] \quad (12)$$

where LP is a number of vehicles demanding service by green signal (pcu), Q_{veh} is the value of the design hourly volume of vehicles approaching the pedestrian crossing on a single traffic lane (pcu/h). The above indicates that for the number of vehicles LP determined in this way, there should be provided the green signal of the following duration:

$$G_{veh} = \lceil LP \cdot t_{serv} \rceil = \lceil 3 \cdot 2.5 \rceil = \lceil 7.5 \rceil = 8, \quad [s] \quad (13)$$

From this solution, we are able to calculate the time G_{veh} needed to serve any number of vehicles calling at the approach to the pedestrian crossing. Thus, for the analysis of the i -th interval of traffic volumes $Q_{veh,i}$, considering the minimum green time in the variable time control operation, we will obtain a formula for the green signal duration ensuring service of the vehicles approaching the crossing:

$$G_{veh,i} = \lceil LP_i \cdot t_{serv} \rceil \geq 5, \quad [s] \quad (14)$$

where i is the number of analysis interval.

Certainly, when extending the duration of the green signal G_{veh} beyond the minimum value $G_{min.veh}$ we should allow for this extension in the vehicle service time in the signaling cycle length T . This extension is conventionally referred to as T_{inc} . Hence, after taking into account the extension in the duration of the green signal at the next stage of calculations we should consider the extended time of the cycle T , during which vehicle calls can occur:

$$LP_i = \left\lceil \frac{Q_{veh,i}}{3600} \cdot (T + T_{inc,i-1}) \right\rceil, \quad [pcu] \quad (15)$$

$$T_{inc,i} = G_{veh,i} - G_{min.veh}, \quad [s] \quad (16)$$

with $T_{inc,0} = 0$.

The following algorithm of the solution was assumed based on models (14), (15) and (16):
if:

$$G_{veh,i} \leq G_{min.veh} \quad (17)$$

then:

$$G_{set.veh,i} = G_{min.veh}, \quad [s] \quad (18)$$

$$T_{min,i} = T, \quad [s] \quad (19)$$

and if:

$$G_{veh,i} > G_{min.veh} \quad (20)$$

then:

$$G_{set.veh,i} = G_{veh,i}, \quad [s] \quad (21)$$

$$T_{min,i} = T + (G_{set.veh,i} - G_{min.veh}) \leq 60, \quad [s] \quad (22)$$

where $G_{set.veh,i}$ is duration of the set green signal for vehicles (s), and $T_{min,i}$ is minimum signaling cycle length (s) – continuous actuation, no extension of green signals.

The above cycle lengths T refer obviously to the values of minimum green times for pedestrians and intergreen times (see formula (10)) determined in the analyses. Based on the determined $G_{set.veh,i}$ values and further correlation and regression analyses, the obtained form of the function is:

$$G_{set.veh} = 3,4323 \cdot e^{0.0026Q_{veh}}, \quad [s] \quad (23)$$

with the value of the Spearman's rank correlation coefficient $r_s = 0.976$.

These results formed a basis for more detailed analyses for the assumed values of traffic volumes Q_{veh} from the 50÷950 pcu/h range, but at the iteration step of 10 pcu/h. The 950 pcu/h threshold results from the possibility of serving the maximum number of vehicles over a 1-minute cycle (see formula (10)). Using the determined relationship (23), the obtained results of $G_{set.veh}$ were rounded up to integers. When carrying out the analyses involving matching of the functions to the variables obtained, finally it was assumed that:

$$G_{set.veh} = \lceil 3.86 \cdot e^{0.0024Q_{veh}} \rceil \leq 38, \quad [s] \quad (24)$$

with: $Q_{veh} < 50 \rightarrow G_{set.veh} = 5$

The verification was performed by linearization of the above nonlinear models, transforming them to:

$$\ln G_{set.veh} = \ln 3.86 + 0.0024 \cdot Q_{veh}, \quad [s] \quad (25)$$

For the assumed traffic volume intervals $Q_{veh,i}$ Pearson's linear correlation coefficient values r_p obtained were at the level of 0.998, which indicates a very good matching.

Identical analyses were carried out for the fixed time control data (with the minimum duration of the green signal of 8 s). They showed slight differences in the obtained set green signal duration calculation model and the correlation coefficient. Hence, for practical reasons, only the use of the relationship described with model (24) is recommended, regardless of the type of traffic control.

5.2. Capacity analysis for the set green signal duration for the vehicles in typical area

The traffic capacity and traffic conditions analysis is based on the calculation method used in Poland [43]. The calculation results are given in Table 3 for the pairs $G_{min.veh}$ and $G_{set.veh}$ for

variable time signal control – for traffic volume Q_{veh} values within the 50÷950 pcu/h range. These results demonstrate that the developed method of determining the duration of the green signal for vehicles, even in a critical state of continuous actuation of green phases for pedestrians, will still ensure a very good level of service (LOS I) with lost time not exceeding 13 s/veh. It should also be stressed that the reach of an average vehicle queue does not exceed 100 m up to the inflow traffic volume at the level of 950 passenger cars on a single traffic lane. Identical analyses have also been performed for the fixed-time control, for which average lost time results fluctuated around similar values.

5.3. Optimization of the maximum duration of the set green signal for the pedestrians

The earlier discussion covered the control strategy involving the allocation of the set green time for vehicles $G_{set,veh}$ assuming the duration of the minimum green signal for pedestrians $G_{min,ped}$. In theory, the minimum green signal time guarantees service of a pedestrian who has entered the crossing at the moment of change into the green signal without switching to the flashing green signal during passage. Thanks to this measure, pedestrians are spared from experiencing a stressful situation where the signal changes while they are crossing. The solution developed, as demonstrated in Table 4, guarantees also the capacity of the crossing cross-section at a very good level of service. However, it is not always the case that pedestrians enter the crossing at the onset of the green time. Therefore, it was legitimate to ask whether it was possible to extend the duration of signal G_{ped} without consequential deterioration of the vehicle traffic service?

Hence, it was necessary to verify the maximum duration of the green signal for pedestrians, which can be assumed as the “maximum set duration”, which guarantees a good level of service for vehicles. It was assumed that the cycle length T cannot exceed 1 minute. Apart from the cycle length T , the basic measure of the vehicle traffic service X – the amount of traffic (volume Q to capacity C ratio) is another obvious determinant of the analysis. It is so because it determines the average lost time, and hence the level of service and the length and reach of vehicle queues. Knowing this and taking into account the earlier assumptions, we can write:

$$T_{\max}^{ped.pref} = G_{set,ped} + G_{mig} + t_{mg,ped} + G_{set,veh} + t_{mg,veh} = 60, \quad [s] \quad (26)$$

$$G_{set,ped} = 60 - (G_{mig} + t_{mg,ped} + G_{set,veh} + t_{mg,veh}), \quad [s] \quad (27)$$

where $T_{\max}^{ped.pref}$ is cycle length including the set green time for vehicles $G_{set,veh}$ and pedestrians $G_{set,ped}$, which does not result in excessive time lost by pedestrians (s) and $G_{set,ped}$ is duration of the set green time for pedestrians (s).

For the worst service scenario in the course of the analyses with $Q_{veh} = 950$ pcu/h it was calculated:

$$G_{set,veh} = 3.86 \cdot e^{0.0024950} = 38, \quad [s] \quad (28)$$

Hence, with the earlier assumptions (formula (27)), the minimum condition for pedestrians is verified:

$$G_{set,ped} = 60 - (4 + 6 + 38 + 7) = 5, \quad [s] \quad (29)$$

After adapting the basic formula (8) of the method [30], the traffic lane capacity C for vehicles will be:

$$C = S \cdot \frac{G_{set.veh} + t_Y - 2}{T_{max}^{ped.pref}} \cong 1170, \quad [pcu/h] \quad (30)$$

from which we will finally obtain:

$$X = \frac{Q}{C} = 0.81, \quad [-] \quad (31)$$

The measures of vehicle traffic service for this scenario were given earlier in Table 3. This means that the level of service for the worst-case scenario is assumed to be *LOS II*. The measures of vehicle traffic service for this scenario were compiled earlier in Table 3.

Tab. 3

Comparison of the calculations of traffic condition measures for the minimum green signal $G_{min.veh}$ and pre-timed green signal $G_{set.veh}$ in variable time control operation

Output inflow volume: [veh/h]	Results of calculation of basic measures of vehicle traffic service:							
	Variable time traffic control $G_{min.veh}$				Variable time traffic control $G_{set.veh}$			
	Volume to capacity ratio [-]	Average lost time [s]	Average number of queuing vehicles [veh]	Average queue length [m]	Volume to capacity ratio [-]	Average lost time [s]	Average number of queuing vehicles [veh]	Average queue length [m]
50	0.13	8.47	3	6.2	0.13	8.47	3	6.2
100	0.25	8.98	3	6.2	0.25	8.98	3	6.2
150	0.38	9.79	5	12.4	0.33	9.17	5	12.4
200	0.50	11.15	5	12.4	0.40	9.41	5	12.4
250	0.63	13.56	7	18.6	0.46	9.70	5	12.4
300	0.75	18.49	9	24.8	0.56	10.84	7	18.6
350	0.88	32.11	11	31.0	0.60	11.29	7	18.6
400	1.00	94.69	23	80.6	0.61	10.89	9	24.8
450	1.13	270.06	54	204.6	0.65	11.44	11	31.0
500	1.25	483.89	92	353.4	0.69	12.15	11	31.0
550	1.38	704.80	132	508.4	0.71	11.99	13	37.2
600	1.50	927.88	173	669.6	0.72	12.01	14	43.4
650	1.63	1151.90	213	824.6	0.74	12.14	14	43.4
700	1.75	1376.39	255	985.8	0.76	12.47	16	49.6
750	1.88	1601.16	297	1147.0	0.77	12.21	17	55.8
800	2.00	1826.11	338	1308.2	0.78	12.21	19	62.0
850	2.13	2051.18	380	1469.4	0.79	12.38	20	68.2
900	2.25	2276.34	421	1630.6	0.80	12.30	22	74.4
950	2.38	2501.55	463	1791.8	0.81	12.44	25	86.8

Color designations as in Table 2

Unfortunately, in the course of the analyses it turns out that for smaller $Q_{veh,i}$ values, when using formula (26), traffic lane capacity was reduced significantly due to a very small share of the green time for vehicles G_{veh} in cycle length T . The situation also occurred in the case of fixed allocation of the cycle length T of 60 s. Therefore, to sustain a good level of service and not to exceed the driver delays significantly, in the next step of the analysis it was assumed arbitrarily that the traffic volume to capacity ratio X did not exceed 0.85. In this way, a compromise between the time lost by drivers and the time lost by pedestrians could be achieved. Based on the appropriate transformations, the critical values of the traffic lane capacity C_{crit} , were obtained, above which driver delays tended to increase significantly. Having the pedestrian priority in mind, the assumption of the cycle length T not exceeding 60 s was maintained. Hence, the following equations:

$$C_{crit} = \frac{Q}{0.85}, \quad [pcu/h] \quad (32)$$

$$T_{max.corr}^{ped.pref} = \left\lfloor \frac{S \cdot (G_{set.veh} + t_Y - 2)}{C_{crit}} \right\rfloor \leq 60, \quad [s] \quad (33)$$

$$C_{corr} = \left\lfloor \frac{S \cdot (G_{set.veh} + t_Y - 2)}{T_{max.corr}^{ped.pref}} \right\rfloor, \quad [pcu/h] \quad (34)$$

$$G_{max.set.ped} = T_{max.corr}^{ped.pref} - (G_{mig} + t_{mg.ped} + G_{set.veh} + t_{mg.veh}) \geq 5, \quad [s] \quad (35)$$

where $T_{max.corr}^{ped.pref}$ is cycle length including set green times, critical capacity and the overall length not exceeding 1 minute (s), C_{crit} is the critical value of the traffic lane capacity, above which driver delays reach an unsatisfactory level of service (pcu/h), C_{corr} is the adjusted value of the capacity, which takes into account the length of the cycle using the set green signal times for vehicles and pedestrians (pcu/h) and $G_{max.set.ped}$ is the maximum set green time for pedestrians, still ensuring good vehicle traffic service on the traffic lane (s), $\lfloor \rfloor$ is the symbol of rounding down to the calculated integer.

For the relationships worked out in this manner, calculation results for the set i -th intervals of analyses of traffic volumes $Q_{veh,i}$ are shown in Table 4. These results clearly indicate that, based on the set green times for pedestrians $G_{max.set.ped}$, determined as maximum with continuous actuation by demands from vehicles awaiting service, we can ensure the traffic lane throughput for vehicles with longer than minimum duration of the green time for pedestrians, at the level of service LOS I or II. Only in two cases (when Q_{veh} is greater than 850 pcu/h) was the critical value $d > 45$ s slightly exceeded. The average queue reach values for a single traffic lane do not exceed 50 m, when the inflow volume Q_{veh} is below 650 pcu/h. However, even above this value they are still not greater than 100 m. It's worth noting that the investigation covers scenarios with continuous signal activation, resulting in a one-hourly declared design traffic volume.

Based on the same correlation and regression analyses as those carried out for $G_{set.veh}$, and on the data given in Table 4, the following form of the function was obtained:

$$G_{max.set.ped} = 43.581 \cdot e^{-0.002 \cdot Q_{veh}} \leq 38, \quad [s] \quad (36)$$

with the value of the Spearman's rank correlation coefficient, $r_S = -0.998$.

The above equation (36) should be treated only as an “indication” for selecting the maximum set green time for pedestrians $G_{max.set.ped}$. This is so because it is recommended to determine this signal’s duration from the formula (35), based on the prior knowledge of the duration of the set green time for vehicles $G_{set.veh}$. A comparison of $G_{set.veh}$ and $G_{max.set.ped}$ for cycle lengths determined from the formula (33) depending on vehicle inflow volume Q_{veh} is shown in Fig. 5.

Tab. 4
Results of calculation of vehicle traffic service measures for the analysis of the situation in which the maximum set green times for pedestrians are taken into account

Output inflow volume: Q_{veh} [veh/h]	Results of calculations of the control parameters and traffic lane throughput					Results of calculation of basic measures of vehicle traffic service:			
	$G_{set.veh}$ [s]	C_{crit} [pcu/h]	$T_{max.corr}^{ped.pref}$ [s]	$G_{max.set.ped}$ [s]	C_{corr} [pcu/h]	X [-]	d [s]	K [pcu]	Z_K [m]
50	5	58.82	60	38	180	0.28	25.46	3	6.20
100	5	117.65	60	38	180	0.56	28.76	5	12.40
150	6	176.47	60	37	210	0.71	32.15	7	18.60
200	7	235.29	60	36	240	0.83	38.45	11	31.00
250	8	294.12	55	30	295	0.85	34.37	11	31.00
300	8	352.94	45	20	360	0.83	26.13	11	31.00
350	9	411.76	43	17	419	0.84	23.48	11	31.00
400	11	470.59	45	17	480	0.83	22.24	13	37.20
450	12	529.41	44	15	532	0.85	21.27	14	43.40
500	13	588.24	42	12	600	0.83	18.30	14	43.40
550	15	647.06	44	12	655	0.84	18.02	16	49.60
600	17	705.88	45	11	720	0.83	16.64	16	49.60
650	19	764.71	47	11	766	0.85	16.94	17	55.80
700	21	823.53	48	10	825	0.85	15.99	19	62.00
750	24	882.35	51	10	883	0.85	26.92	20	68.20
800	27	941.18	53	9	951	0.84	35.48	20	68.20
850	30	1000.00	55	8	1015	0.84	42.98	22	74.40
900	34	1058.82	59	8	1068	0.84	52.09	23	80.60
950	38	1117.65	60	5	1170	0.81	49.04	23	80.60

Colour designations as in Table 2 and 4

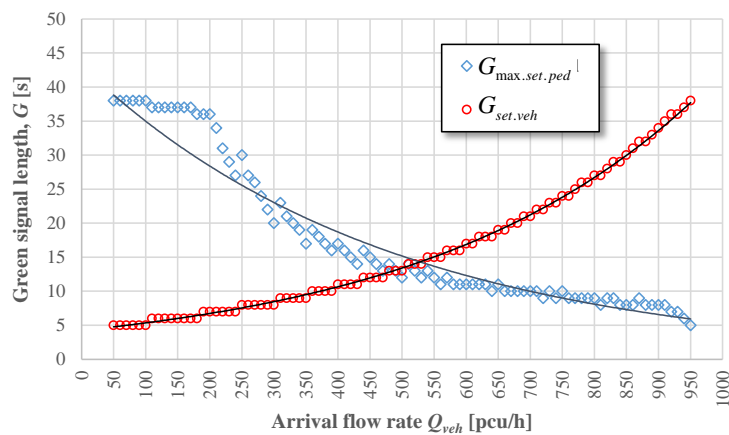

Fig. 5. Comparison of the duration of the fixed green signal for vehicles $G_{set.veh}$ and the maximum green signal for pedestrians $G_{max.set.ped}$ ensuring good level of service

5.4. A proposal of the timing of the maximum green signal for vehicles

The duration of the maximum green time for vehicles $G_{max.set.veh}$ for the pedestrian crossing under analysis is proposed to be determined as follows:

$$G_{max.set.ped} = 43.581 \cdot e^{-0.002 \cdot Q_{veh}} \leq 38, \quad [s] \quad (37)$$

whereof:

$$t_{max.serv} = \left[LZ \cdot t_{start} + t_{LZ.drive} \right], \quad [s] \quad (38)$$

$$LZ = \frac{L_{D2}}{\Delta l_{veh}}, \quad [pcu] \quad (39)$$

$$t_{LZ.drive} = \frac{L_{D2}}{v_{veh.dop}}, \quad [s] \quad (40)$$

where $G_{max.set.veh}$ is the maximum duration of the green signal for serving the vehicles queuing before the pedestrian crossing (s), LZ is the reach of the queue of stopped vehicles in the detection system $D2$ (pcu), L_{D2} is the distance to the initial cross-section of the loop detector $D2$ (m), Δl_{veh} is the average headway between vehicles in the stationary queue per single passenger car, expressed in metres (m/pcu) – in accordance with the Polish method [43] this value is 6.2 m per pcu, t_{start} is the average start time headway for the vehicles in the stationary queue awaiting the green signal (s/pcu), $t_{LZ.drive}$ is the approach time needed to reach the stop line from the beginning of the detection system (s) and $v_{veh.dop}$ is permissible vehicle speed on the approach to the pedestrian crossing (m/s).

Based on the results given in [26] it can be assumed that:

$$t_{start} = \frac{1}{1.45 \cdot s} = \frac{1}{0.725} \cong 1.4, \quad [s / pcu] \quad (41)$$

where s is the value of the saturation volume (pcu/s) – for the case under consideration, $s=0.5$ pcu/s.

Thus, for the example simulated in this article, in which the permissible vehicle speed is 30 km/h, we will obtain:

$$t_{max.serv} = \left[\frac{50}{6.2} \cdot 1.4 + \frac{50}{8.3} \right] = 18, \quad [s] \quad (42)$$

$$G_{max.set.veh} = G_{set.veh} + 18, \quad [s] \quad (43)$$

It is noted that, if the pedestrian priority is sustained, it is necessary to apply a constraint to the above equation (43) in order to reduce pedestrian delay. It is assumed, identically as in the earlier analyses (see formula (26)), that the cycle length, with the minimum green time duration for pedestrians, should not exceed 60 s. Hence:

$$G_{\max.set.veh}^{ped} = G_{set.veh} + t_{\max.serv} \leq 38, \quad [s] \quad (44)$$

because:

$$T_{\max} = G_{\min.ped} + G_{mig} + t_{mg.ped} + G_{\max.set.veh}^{ped} + t_{mg.veh} = 60, \quad [s] \quad (45)$$

$$G_{\max.set.veh}^{ped} = 60 - (5 + 4 + 6 + 7) = 38, \quad [s] \quad (46)$$

The formula (44) secures the reduction of pedestrian delay down to the accepted minimum, so it works in line with the prioritization strategy as regards this group of road users. The selection of the limit values of the maximum duration of both the green time for vehicles and the cycle length is left for traffic signal program designers to analyze. Considering the maximum set duration of the green signal for pedestrians $G_{\max.set.ped}$, we will finally obtain:

$$G_{\max.set.veh}^{ped.pref} = 60 - (G_{\max.set.ped} + G_{mig} + t_{mg.ped} + t_{mg.veh}), \quad [s] \quad (47)$$

The last model (47) secures the reduction of pedestrian delay down to the minimum determined by the cycle length, and thus it works in compliance with the assumed pedestrian priority strategy for the one-minute cycle duration. The final selection of the limit values of the maximum duration of both the green time for vehicles and the cycle length is left to traffic signal program designers to analyze.

It should be noted that the proposed method is the reflection of the worst-case vehicle service scenario. It is so because it shows a potential situation in which no vehicle within the queue stopped before the pedestrian crossing has performed the start manoeuvre yet. Therefore, it is assumed that on the elapse of the service time $G_{set.veh}$, the control algorithm will still allow for the service of the vehicles standing over the detection system $D2$, unless the selected duration of the set signals for pedestrians within the assumed 1-minute cycle length does not allow this.

5.5. Adaptive control algorithm to ensure vehicle traffic throughput

Choosing the appropriate traffic signal controller is one of the most important factors in road traffic control. To obtain the greatest operational benefits, it is always recommended to choose much more expensive adaptive (variable time) control solutions, depending on the current traffic characteristics (volume of vehicle and pedestrian demands).

If the designer or the traffic management body chooses actuated fixed time control, in which traffic signals show the green signal for pedestrians continuously and the green time for vehicles is allocated on an ongoing basis on demand, it is suggested that the model (24) should be employed to determine the duration of the fixed green signal for vehicles $G_{set.veh}$ and for pedestrians $G_{\max.set.ped}$ in accordance with the formula (35). In this way, the adequate level of service will be sustained, ensuring minimization of delays with pedestrian priority being sustained at the same time. This solution is also recommended as emergency control in case of the detection system failure.

In the case of more complex traffic control, considering temporary traffic obstruction and possible congestion on a given road section, the use of the model (47) for determination of the fixed green signal $G_{set.veh}$ is suggested for variable time control with taking into account the maximum green signal durations for vehicles and with the sustained pedestrian priority in accordance with the model (35). It is proposed to employ as many as three vehicular traffic detection systems, $D1$, $D2$ and $D3$ on a given lane in this case. The schematic diagram of

the traffic control devices is shown in Fig. 6. The (phase) traffic control program is shown in Fig. 7. The traffic control algorithm is given in Fig. 8. The logical conditions of the algorithm are described in Table 5. The comments on Figure 6 are as follows:

- on the north lane the detector designations include index *a* (*Da1*, *Da2* and *Da3*), and on the south lane – index *b* (*Db1*, *Db2* and *Db3*, respectively),
- pedestrian detectors occur only in the traffic signal system employing the “all red” control strategy,
- green signal unit extension ΔG :
-

$$\Delta G = \{2.0; 5.0\} \quad [s] \tag{48}$$

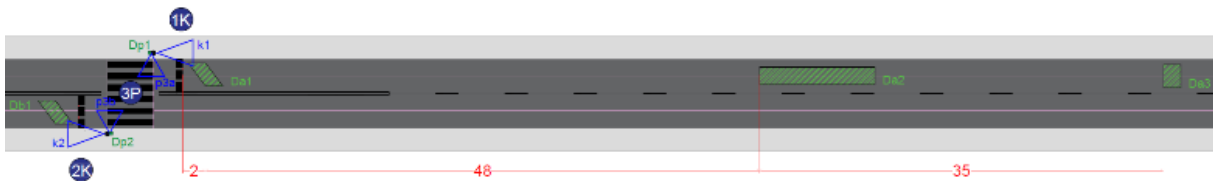

Fig. 6. Arrangement of traffic control devices in [m] for variable time control and for the permissible vehicle speed $v_{veh,dop} = 8,33$ m/s (designations of variables as in Fig. 2)

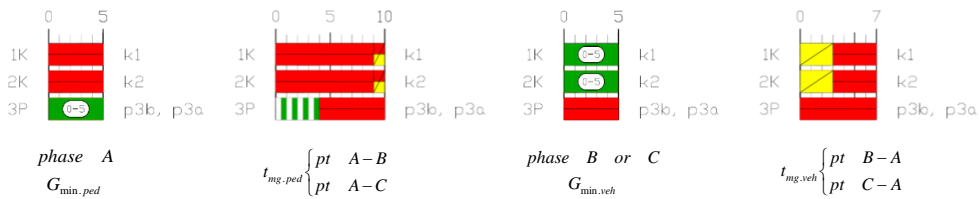

Fig. 7. Traffic control program with signal phasing for the fixed state in phase A and actuated state in phases B or C (designations of variables as before – compatible with Fig. 8)

The algorithm is made up of two main signal phases, i.e. phase A of the set green signal for pedestrians (for minimum 5 s) and phase B or C of the green signal for vehicles (also for minimum 5 s). It is recommended that the duration of the green signal shown to pedestrians should be selected from the range:

$$G_{ped} = \{G_{min.ped}; G_{max.set.ped}\}, \quad [s] \tag{49}$$

taking into account the fact that the selected cycle length should not exceed 60 s. The duration of the green signal for vehicles G_{veh} depends on the traffic situation prevailing directly before the pedestrian crossing in a given traffic lane. Phase B is the traffic phase in which the vehicles are served over the duration of the minimum green signal $G_{min.veh}$ with its possible extension to reach the duration of the set green signal $G_{set.veh}$. Phase C is the traffic phase, ensuring vehicle service with the omission of the minimum green signal for vehicles $G_{min.veh}$ and with possible extension of this signal's duration up to the maximum fixed value $G_{max.set.veh}$.

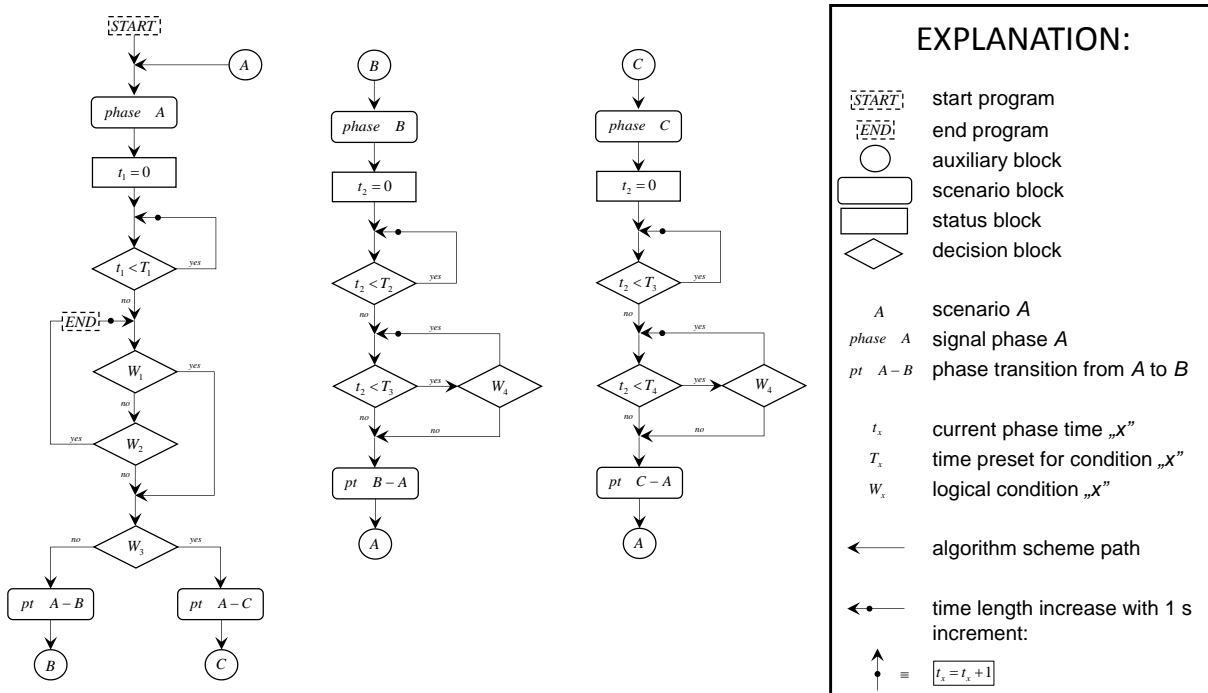

Fig. 8. Traffic control algorithm taking into account the durations of the set green signals

The detection system must be additionally protected against potential loop detector damage in the signal controller. It is proposed that in the situation when detection systems *D1*, *D2* or *D3* are continuously actuated over the period longer than 300 s or if no signal is generated by these systems during the traffic signal operation, the controller should start emergency operation and switch into the traffic control mode as for the fixed time program with the declared durations of the fixed green signals for vehicles $G_{set.veh}$, and for pedestrians $G_{max.set.ped}$ and the cycle length allocated to them as per the equation:

$$T_{max}^{fix.time} = G_{max.set.ped} + G_{mig} + t_{mg.ped} + G_{set.veh} + t_{mg.veh} = 60, \quad [s] \quad (50)$$

Tab. 5
Characteristics of logical conditions in decision blocks of the traffic control algorithm

Name of logical condition	Description of logical condition
W_1	has the detection system <i>D3</i> (detectors <i>D3a</i> or <i>D3b</i>) captured vehicle speeds v_{veh} below the permissible speed $v_{veh,dop} = 8.33$ m/s ?
W_2	does the detection system <i>D1</i> (detectors <i>D1a</i> or <i>D1b</i>) remain unactuated?
W_3	does constant actuation of the detection system <i>D2</i> (detectors <i>D2a</i> or <i>D2b</i>) occur?

W_4	is the time gap Δt of detection system DI (detectors DIa or DIb) smaller than the unit extension of the green signal duration ΔG ?
T_1	assumed duration of the green signal for pedestrians: $G_{ped} = \{G_{min.ped}; G_{max.set.ped}\}$
T_2	minimum duration of the green signal for vehicles, determined by the law: $G_{min.veh}$
T_3	duration of the set green signal for vehicles: $G_{set.veh}$
T_4	maximum duration of the set green signal for vehicles: $G_{max.set.veh}^{ped.pref}$

Of course, the above proposal is only the simplest form. There are many combinations of programming traffic light controllers, maintaining green signal periods for vehicles designed, for example, for the coordination of adjacent traffic lights or other conditions for shortening and extending the signal allowing for road users (e.g. when a pedestrian is in the pedestrian crossing detection field). The specificity of the control depends on the ingenuity of the program designer and the complexity of the road and traffic situation. Nevertheless, under the established traffic load conditions, the condition of maximum green signal doses for vehicles was simulated in order to check the lane capacity. Similarly, based on the detection of pedestrian movement, whether from infrared sensors or image analysis (objects), it is possible to extend the periods of green signals at the pedestrian crossing. It is also possible to extend the periods of phase-to-phase transitions during the so-called driver's dilemma zone during the change of traffic signals from green to red.

6. CONCLUSIONS AND RECOMMENDATIONS

This article is devoted to an analysis of the optimization of the durations of the green signals for pedestrians and vehicles in the traffic control systems operating outside the area of influence of road intersections. Its unquestionable advantage is working out the dependencies enabling easy application of the computational model for determining the green signal duration, ensuring adequate service to road traffic participants with minimum travel delays. Simple dependencies were developed for only one traffic variable, namely for the volume of vehicles approaching the pedestrian crossing on a given traffic lane.

The subject of the article fits into the objectives of the transport policy in many countries all over the world, aimed at ensuring road safety and promoting traffic-calming in sensitive areas with a high level of urbanization. Traffic signals are frequently installed in such places at the intersection of the traffic streams of unprotected and motorized road users, in particular in places with a very heavy pedestrian traffic. The analyses included typical cross-sections of such signalized pedestrian crossings.

The developed models of green signal timing guarantee a good level of service under continuous, maximum traffic flow conditions at the analyzed pedestrian crossings. As a result, they offer a very good protection for traffic signal controllers if traffic detection systems are in use, as then it is not a rare situation that only minimum green times or green times assumed without any traffic analyses are programmed into the controller. In the extreme situations for the solution developed, vehicle queue lengths do not exceed 100 m and the average time delay obtained in the analyses of a one-hour interval fluctuates around 50 s/pcu. Hence, the compromise between the pedestrian and driver delay is considered to be achieved at the assumed cycle length of 60 s.

The functions developed can find practical application at pedestrian crossings in Poland but also in any other country, provided the method of their timing is adapted considering the local procedures and requirements as to the duration of the minimum green times and intergreen times. What is more, the described traffic control algorithm based on the developed models makes it possible to prioritize pedestrian traffic at the sites under analysis. The developed traffic control scenario can be employed both at isolated traffic signal locations and for groups of traffic signals coordinated along an arterial or within an area.

Models (24), (35) and (47), along with the proper interpretation of model (50), are recommended for practical application by:

- road traffic engineers who design isolated traffic signal programs,
- programmers of linear and area traffic control systems,
- traffic management bodies responsible for the implementation and verification of traffic management over the operating period of the implemented traffic control solutions.

The proposed solution has been developed for the purpose of traffic control in places particularly frequented by pedestrians. The method is recommended for use for the design hourly traffic volumes up to 700 pcu/h/lane. Maximum vehicle traffic inflow volumes up to 950 pcu/h/lane) are allowed. On the other hand, the method is not recommended for pedestrian crossings installed on multilane single and dual carriageway roads and streets instead of grade-separated crossings. For traffic safety reasons, including in particular the safety of unprotected road users, alternative solutions, which ensure separation of the conflicting motorized and non-motorized traffic streams should be employed.

References

1. Act: Road Traffic Law: *Journal of Laws of the Republic of Poland* (Dz.U.2023.1047 t.j.).
2. Act: Vienna Convention on Road Traffic Law (1985): Dz.U.1988.5.40.
3. Akcelik R. 1981. Traffic signals: capacity and timing analysis. *Publication of: Australian Road Research Board* 3.
4. Allsop R.E. 1971. "A diagram showing practicable settings for a fixed-time traffic signal and their effect on delay". *Transportation Research* 5(1).
5. Approved road traffic organizations and materials made available in the technical interview - Municipal Roads Authority in Bydgoszcz, Poland (2019-2023).
6. Approved road traffic organizations and materials made available in the technical interview - Municipal Roads Authority in Łódź, Poland (2020-2021).
7. Approved road traffic organizations and materials made available in the technical interview - Municipal Roads Authority in Kraków, Poland (2021).

8. Approved road traffic organizations and materials made available in the technical interview - Municipal Roads Authority in Warszawa, Poland (2022-2023).
9. Approved road traffic organizations and materials made available in the technical interview - Municipal Roads Authority in Gdańsk, Poland (2020-2021).
10. Approved road traffic organizations and materials made available in the technical interview - Municipal Roads Authority in Poznań, Poland (2021).
11. Ash R., D. Ofri, J. Brokman, I. Friedman, Moshe Y. 2018. "Real-time Pedestrian Traffic Light Detection". *2018 IEEE International Conference on the Science of Electrical Engineering in Israel (ICSEE)*. Eilat, Israel.
12. Chodur J., K. Ostrowski, M. Tracz. 2016. "Variability of capacity and traffic performance a turban and rural signalised intersections". *Transportation Research Procedia* 15.
13. Czech P. 2017. „Physically disabled pedestrians - road users in terms of road accidents”. *Advances in Intelligent Systems and Computing* 505: 33-44. DOI: https://doi.org/10.1007/978-3-319-43991-4_4. Springer, Cham. ISBN: 978-3-319-43990-7; 978-3-319-43991-4. ISSN: 2194-5357. In: Sierpinski Grzegorz (eds), Intelligent transport systems and travel behaviour, 13th Scientific and Technical Conference „Transport Systems Theory and Practice”, Katowice, Poland, September 19-21, 2016.
14. Czech P. 2017. „Underage pedestrian road users in terms of road accidents”. *Advances in Intelligent Systems and Computing* 505: 33-44. DOI: https://doi.org/10.1007/978-3-319-43991-4_4. Springer, Cham. ISBN: 978-3-319-43990-7; 978-3-319-43991-4. ISSN: 2194-5357. In: Sierpinski Grzegorz (eds), Intelligent transport systems and travel behaviour, 13th Scientific and Technical Conference „Transport Systems Theory and Practice”, Katowice, Poland, September 19-21, 2016.
15. Evstatiev B., T. Balbuzanov, I. Beloev, V. Pencheva. 2019. "Intelligent system for improved safety on pedestrian traffic lights". *Transport Problems* 14(1).
16. Handbuch für die Bemessung von Straßenverkehrsanlagen. *Forschungsgesellschaft für Straßen- und Verkehrswesen e. V.* 2001. Berlin, Germany.
17. Hassan S.A., O.C. Puan, N. Mashros, N.S. Abdul Sukor. 2014. "A review into traffic signal improvement at pedestrian signalised crossings". *Jurnal Teknologi* 70(4).
18. Hie X., S.F. Smith, T. Chen, G.J. Barlow. 2014. "Real-time traffic control for sustainable urban living". *17th International IEEE Conference on Intelligent Transportation Systems (ITSC) 2014*.
19. Highway Capacity Manual. *Transportation Research Board*. 2000. Washington, DC, USA.
20. Hua W. Z. Guanjie, G. Vikash, L. Zhenhui. 2019. "A survey on traffic signal control methods". *arXiv.org*.
21. Iwanowicz D., J. Chmielewski. 2020. "Analysis of the methods of traffic evaluation at the approaches of urban signalised intersections". *Nodes in Transport Networks - Research, Data Analysis and Modelling*. Springer International Publishing.
22. Iwasaki Y. 1999. "A measurement method of pedestrian traffic flows by use of image processing and its application to a pedestrian traffic signal control". *Proceedings 199 IEEE/IEEJ/JSAI International Conference on Intelligent Transportation Systems*. Tokyo, Japan.
23. Kothuri S., E.J. Smaglik, A. Kading, C. Sobie, P. Koonce. 2018. "Guidance on signal control strategies for pedestrians to improve walkability". *Institute of Transportation Engineers* 88(5). ITE Journal.
24. Liu Q., J. Xu. 2012. "Study on the signal control problem with pedestrians non-complying". *Proceedings of the 10th World Congress on Intelligent Control and Automation*. Beijing, China.

25. Ma D., X. Luo, S. Jin, D. Wang, W. Guo, F. Wang. 2017. "Lane-based saturation degree estimation for signalized intersection using travel time data". *IEEE Intelligent Transportation Systems Magazine* 9(3).
26. Macioszek E., D. Iwanowicz. 2021. "A back-of-queue model of a signal-controlled intersection approach developed based on analysis of vehicle driver behavior". *Energies* 14(4).
27. Mathieu S. "Specific pedestrian crossing traffic lights". 1990. *Third International Conference on Road Traffic Control*.
28. Road Accidents in Poland 2010-2022. Motor Transport Institute. 2011-2022. Warsaw.
29. Ohno K., H. Mine. 1973. "Optimal traffic signal settings – II. A refinement of Webster's method". *Transportation Research* 7(3).
30. Oskarbski J., K. Jamroz. 2015. "Reliability and safety as an objective of intelligent transport systems in urban areas". *Journal of KONBiN* 2(34).
31. Ostrowski K., M. Budzyński. 2019. "Modelling signalised intersections reliability of functioning". *IOP Conference Series: Materials Science and Engineering* 471(6).
32. Pashupatimath S.G., S. Madhavanavar. 2018. "Different techniques used in traffic control system: an introduction". *International Journal of Engineering Research & Technology. NCICCT – 2018 Conference Proceedings (Special Issue)*.
33. Guidelines for the design of pedestrian infrastructure. Part 3: Pedestrian crossings. *Patterns and standards recommended by the Minister responsible for transport in Poland*. 2021.
34. Electronic search engine for road incidents and reports. Polish Police Headquarters (2022). "Accident and Collision Registration System".
35. Regulation on detailed technical conditions for road signs and signals and road safety devices and the conditions for their placement on the roads. *Journal of Laws of the Republic of Poland*. (Dz.U.2019.2311 t.j. ze zm.).
36. Regulation on road signs and signals. *Journal of Laws of the Republic of Poland*. (Dz.U.2019.2310).
37. Sun D., D. Wang, Y. Chen, W. Guo. 2011. "Study on Pedestrian Signal Cycle Optimization". *2011 Fourth International Conference on Intelligent Computation Technology and Automation*. Shenzhen, China.
38. Szczuraszek T., D. Iwanowicz. 2015. "The analysis of calculation methods of vehicle queue lengths in front of intersection inlets with traffic lights". *Logistyka* 4.
39. Szczuraszek T., et al. 2016. *A study of the sustainable development of transport systems in the Bydgoszcz and Toruń poviats, with particular emphasis on the cities of Bydgoszcz and Toruń*. "UTP Development" Foundation. Bydgoszcz.
40. Szczuraszek T., et al. 2013. *Transport study of the Kujawsko-Pomorskie Voivodeship for the purposes of the sustainable development plan for public transport (stage I and II)*. "UTP Development" Foundation. Bydgoszcz.
41. Thakur S., S. Biswas. 2019. "Assessment of pedestrian-vehicle interaction on urban roads: a critical review". *Archives of Transport* 51(3).
42. Tomczuk P., M. Chrzanowicz, T. Mackun, M. Budzyński. 2021. "Analysis of the results of the audit of lighting parameters at pedestrian crossings in Warsaw". *Archives of Transport* 59(3).
43. Tracz M., J. Chodur, S. Gaca, S. Gondek, M. Kieć, K. Ostrowski. 2004. "The method of calculating the capacity of intersections with traffic lights". *General Directorate of National Roads and Highways*. Warsaw.

44. Vilarinho C., J.P. Tavares. 2014. "Real-time Traffic Signal Settings at an Isolated Signal Control Intersection". *Transportation Research Procedia* 3.
45. Wang Y., C. Qian, D. Liu, J. Hua. 2019. "Research on pedestrian traffic safety improvement methods at typical intersection". *4th International Conference on Electromechanical Control Technology and Transportation (ICECTT)*.
46. Wawrzonek T. 2021. "Traffic light as an element of traffic calm – case study of Gdansk". *Specialist Conference „VIII Krakow Road Safety Days”*. 2021. Cracow.
47. Wawrzonek T. 2020. "Why is it not worth making traffic lights sometimes?" *Specialist Conference „Traffic Light”*. Cracow.
48. Yasaşwin B.A.O.S., T.M.K.K. Jinasena. 2019. "Automated, low-cost pedestrian crossing carriage for efficient traffic control and pedestrian safety". *International Research Conference on Smart Computing and Systems Engineering (SCSE)*.
49. Webster. F. 1957. "Traffic signal settings". *Road Research Technical Paper*. No 39. Department of Scientific and Industrial Research. London, England.
50. Zhang G., J. Chen. 2009. "Study on saturation flow rates for signalized intersections". *International Conference on Measuring Technology and Mechatronics Automation*.
51. Zhang Y., Y. Zhang, R. Su. 2021. "Pedestrian-safety-aware traffic light control strategy for urban traffic congestion alleviation". *IEEE Transactions on Intelligent Transportation Systems* 22(1).
52. Zhou Z.N., Z.K. Shi, Y.F. Li. 2008. "Traffic Signal Optimization with Vehicles Queue and the Number of Pedestrians Non-Complying at Single Intersection". *2008 Workshop on Power Electronics and Intelligent Transportation System*. Guangzhou, China.

Received 03.11.2023; accepted in revised form 25.01.2024



Scientific Journal of Silesian University of Technology. Series Transport is licensed under a Creative Commons Attribution 4.0 International License