

Impact of Seat and Back Angle Settings on Seating Furniture Quality: An Experimental Study

EWA SKORUPIŃSKA^{1,2}, KRZYSZTOF WIADEREK³, MACIEJ SYDOR¹

¹ Department of Woodworking and Fundamentals of Machine Design, Faculty of Forestry and Wood Technology, Poznań University of Life Sciences, 60-637 Poznań, Poland

² Euroline sp. z o.o., Leszno, Poland

³ Department of Furniture Design, Faculty of Forestry and Wood Technology, Poznań University of Life Sciences, 60-637 Poznań, Poland

Abstract: *Impact of Seat and Back Angle Settings on Seating Furniture Quality: An Experimental Study.* The fundamental measure of the quality of seating furniture is seating comfort. Sitting comfort is described in the literature by the discomfort coefficient D , calculated from the pressure values and distribution measured between the human body and a sitting furniture "body support system". The work aims to experimentally verify the influence of selected anthropometric features on sitting comfort. The research was carried out on 12 people using a piezoelectric sensor mat and a model of adjustable sitting furniture. The study investigated how different seat and backrest inclination variants impact pressure distribution. The test results are the values of the contact pressures and discomfort coefficients D for nine combinations of the backrest and seat inclination related to the anthropometric characteristics of the tested group of people. The results indicate that anthropometric factors, such as body mass index (BMI) and user gender, significantly impact objective seating comfort. These findings will help optimize the seating furniture dimensions at their design stage.

Keywords: anthropometry; furniture design; furniture design quality; furniture quality; pressure

INTRODUCTION

Scientific analyzes of the sitting position and the adjustment of furniture to the physiological features of a human were started by Franz Staffel in 1884, postulating that in the sitting position, the spine should be supported only in its lumbar part (Rybczyński, 2016). It was only later that the principle of correct sitting was defined, stating the need to shape the backrest's upper part to match the spine's thoracic portion. Those postulates were related to the assumption that in seating furniture, seat sizes are closely associated with the anatomy of the furniture user. In other words, fitting the user is essential in designing this product type. The interconnection of technical and ergonomic design is based on the principle resulting from the characteristic of anthropometric ergonomics, i.e., recognizing the priority of human physiological needs and shaping products to those identified needs (Tilley & Dreyfuss, 2002). Designing ergonomic furniture for sitting involves developing several interdisciplinary features closely related to the knowledge of furniture design, production technology, anthropometry, and human physiology.

The seating furniture ergonomics can be decomposed into several factors that affect sitting comfort (Smardzewski, 2015). These are the level of contact pressures occurring at the interface of the seat and the user's body, body composition (i.e., weight, size, and gender), sitting time, and sitting style. It should be emphasized that the body's structure significantly affects the formation of ailments due to prolonged sitting.

The Body Mass Index (BMI), developed by the Belgian mathematician and statistician Adolphe Quetelet in the early 19th century, facilitates the comparison of individuals with one another, simplifying the process. BMI stands for Body Mass Index. It is a numerical value

calculated using a person's height and weight. The formula for calculating BMI is a body weight (in kilograms) divided by the square of height (in meters). The BMI value in the 20 to 25 kg/m² range is deemed appropriate (Miklosik et al., 2022). It's important to note that while BMI is a valuable tool for population studies and initial assessments, it does not account for variations in body composition, such as muscle mass or distribution of fat, and should be interpreted cautiously, especially in the case of athletes or individuals with higher muscle mass.

Sitting comfort refers to the degree of comfort experienced by an individual when seated or sitting for an extended time. It is a subjective perception that varies from person to person and can be influenced by various factors, such as the design and arrangement of seating furniture, cushioning, and padding, and human features (BMI, age, gender, body composition) (Wiaderek, 2012; Hitka et al., 2022; Sydor & Hitka, 2023; Hitka et al., 2023). Despite these difficulties, some methods can be used to assess seating comfort. For example, asking users to complete surveys in which they assess their seating comfort. Objective but indirect measurement methods are also used, such as electromyography (EMG) measuring tense elections or tracking systems to determine how sitting affects posture and how often you change posture. The postural analysis involves analyzing the alignment and posture of an individual when seated. This can be done through visual observation or using motion capture systems that track body movements. It helps evaluate whether the seating position promotes proper spinal alignment and supports different body regions adequately (De Looze et al., 2003).

Discomfort is related to the value of contact stresses and the uniform distribution of these stresses on the contact surface (Milivojevich et al., 2000; Matwiej et al., 2016; Wiaderek et al., 2019). The Seat Pressure Distribution (SPD) was developed to quantitatively assess the uniformity of pressure distribution across the seat surface. It measures how pressure is distributed across different seat regions (Seigler et al., 2003). The formula (1) expresses the SPD:

$$SPD = \frac{\sum_{i=1}^n (p_i - p_m)^2}{4 n p_m^2} \times 100 \quad (\%) \quad (1)$$

where:

n – number of non-zero sensors (pcs.),

p_i – contact stress on the sensor (kPa),

p_m – average contact stresses on the sensors (kPa).

A lower value of the SPD coefficient indicates a more favorable uniform stress distribution on the seat surface.

Knowing the value of the maximum pressures, the SPD coefficient, and the contact surface of the body with the seat, can be included by the discomfort coefficient D , which is expressed by the formula (2) (Smardzewski et al., 2014):

$$D = \frac{p_m \times SPD}{A} \left(\frac{N}{m^4} \right) \quad (2)$$

where:

A – active contact area between the human body and sitting furniture (m).

Low values of the D coefficient objectively determine the comfort of using the seats. Thus, the contact stress value, SPD coefficient, and active contact area A most impact seat comfort.

The study aimed to experimentally verify the influence of selected anthropometric features on seat comfort in seating furniture by determining the value of the discomfort coefficient D .

MATERIALS AND METHODS

Pressure tests were conducted on a test stand, allowing for the adjustment of seat inclination angles (α) at 0° , 7° , and 11° , as well as backrest inclination angles (β) relative to the α angle at 90° , 100° , and 105° . Eight combinations of α and β angles were used: 0.100, 0.105, 11.100, 11.105, 11.90, 7.100, 7.105, and 7.90. The reference position was the combination of the α seat inclination angle of 0° and the angle of the backrest to the seat (β) of 90° (0.90). A fixed front edge height of the seat of 430 mm and a fixed seat depth of 490 mm is specified. In the test stand, polyurethane upholstery foam with a thickness of 30 mm was used as the elastic material with the following parameters: apparent density 37 kg/m^3 (according to ISO 845: (2006)), Compression load Deflection (CLD) 3.42 kPa to compress a foam sample by a 40% of its original thickness (according to ISO 3386-1: (1986)), elasticity at reflection not less than 55% (according to ISO 8307: (2018a)), permanent deformation not more than 5% (according to ISO 1856: (2018b)).

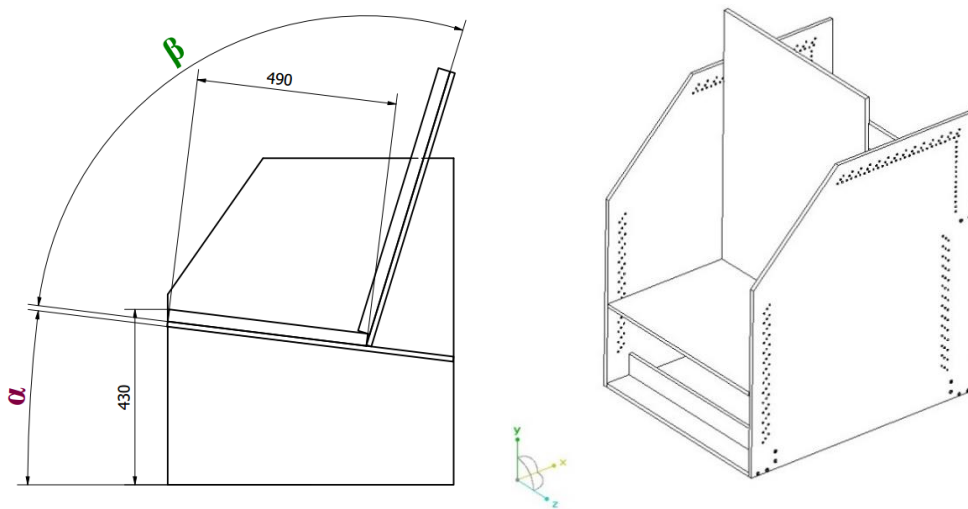

Figure 1. Test stand used in the pressure tests

The contact pressure measurement tool was a 630×630 mm mFlex type pressure mapping mat with an array of 32×32 sensors (FSA/mFlex, Canada) and Force Sensitive Applications software.

Twelve volunteers, six women, and six men, participated in the research. Each of the 12 volunteers took a position on the seat nine times, i.e., for each geometric variant. Measurements of pressure on the contact surface of the user's body with the seating furniture were preceded by an interview with each of the 12 volunteers, during which the necessary information was recorded to determine the BMI of the respondent. These were: height expressed in centimeters, body weight in kilograms, and age in years.

RESULTS AND DISCUSSION

Laboratory tests allowed observing how pressure is distributed while sitting by women and men with different BMI in different backrest and seat configurations. Figures 2-9 show the influence of BMI and seating furniture arrangement on the value of the D factor.

Figure 2 shows that the discomfort coefficient D varies with similar BMI in men (26.9; 26.2; 26.5). Similar results were obtained for women (Fig. 3). With an almost equal BMI (26.7 and 26.9), the discomfort coefficient D varies.

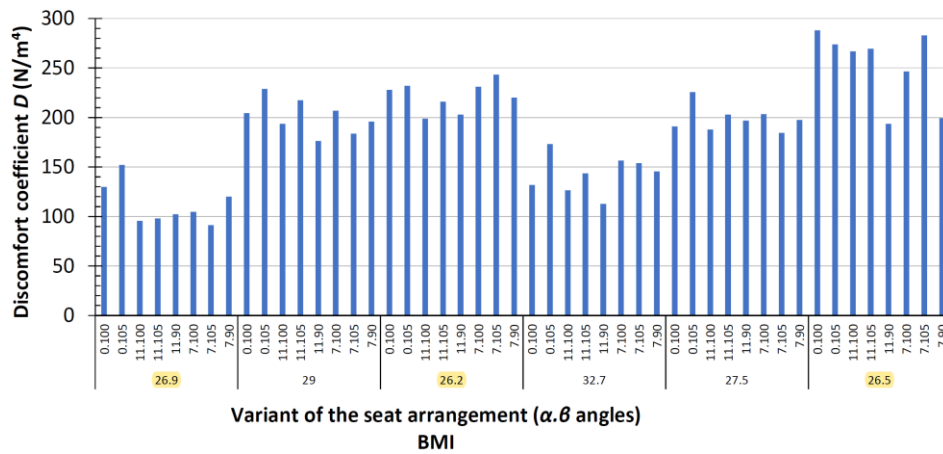

Figure 2. Discomfort coefficient s calculated for men with different BMI interacting with various seat arrangements

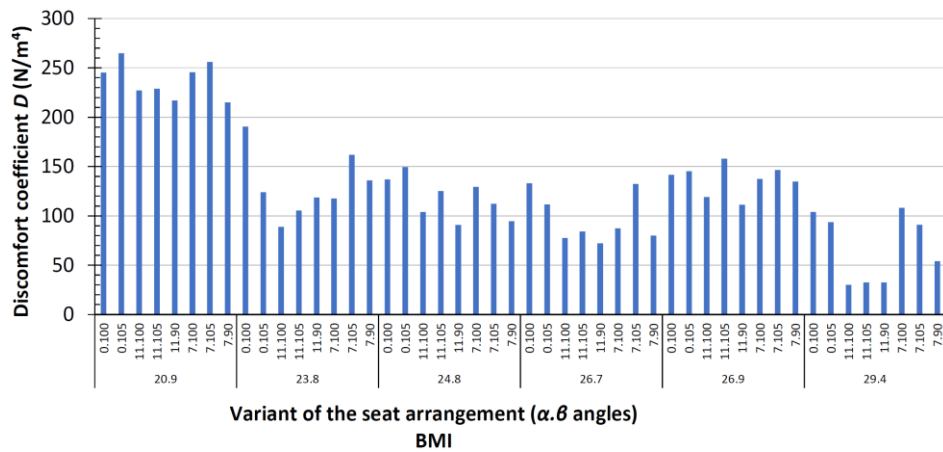

Figure 3. Discomfort coefficient calculated for women with different BMI interacting with various seat arrangements

Number of active sensors. Men with a higher BMI have more active sensors (Fig. 4). The seat-back configuration shows a slight effect on the number of active sensors.

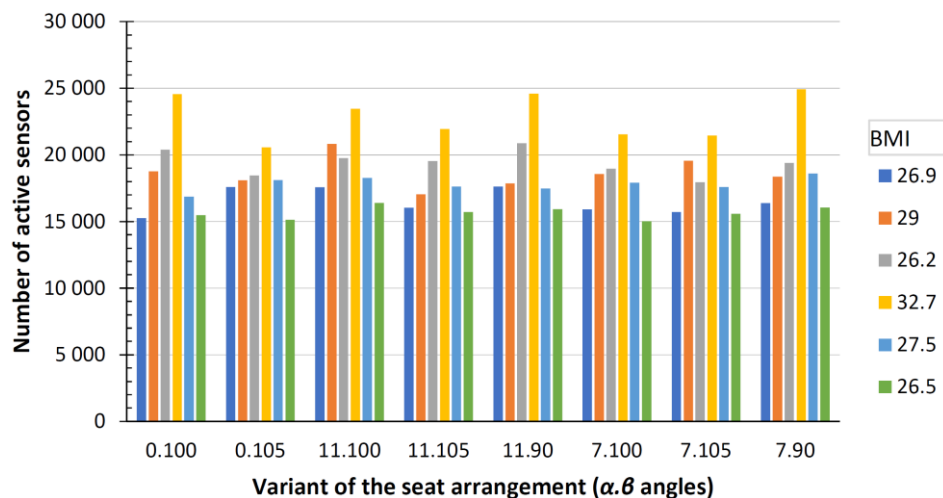

Figure 4. Number of active sensors measured for men with different BMI interacting with various seat arrangements

A similar picture was observed for women (Fig. 5 shows that the women with a higher BMI have more active sensors). The furniture arrangement (α and β angles variants used) slightly affects the number of active sensors.

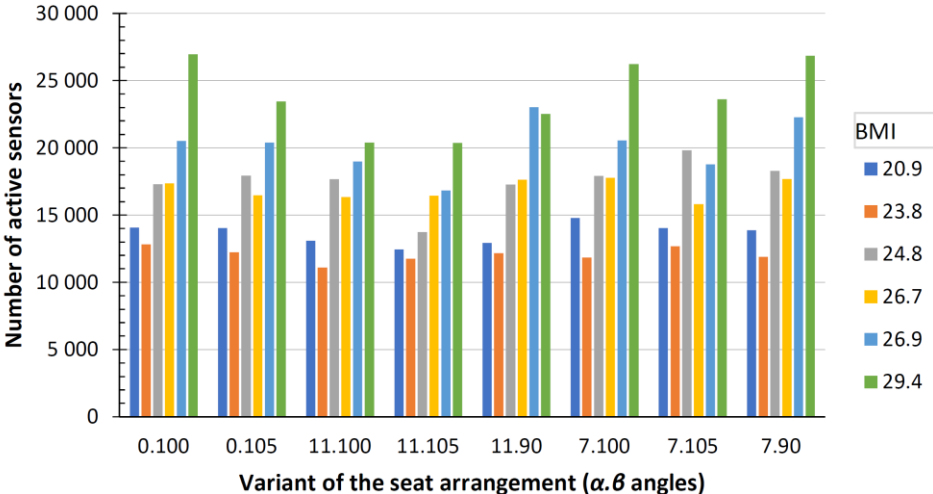

Figure 5. Number of active sensors measured for women with different BMI interacting with various seat arrangements

Average stress on the sensor. Men's BMI does not unambiguously influence the average pressure on the sensor (Fig. 6). Similar BMIs (26.9, 26.2, and 26.9) show different average strains on the sensor.

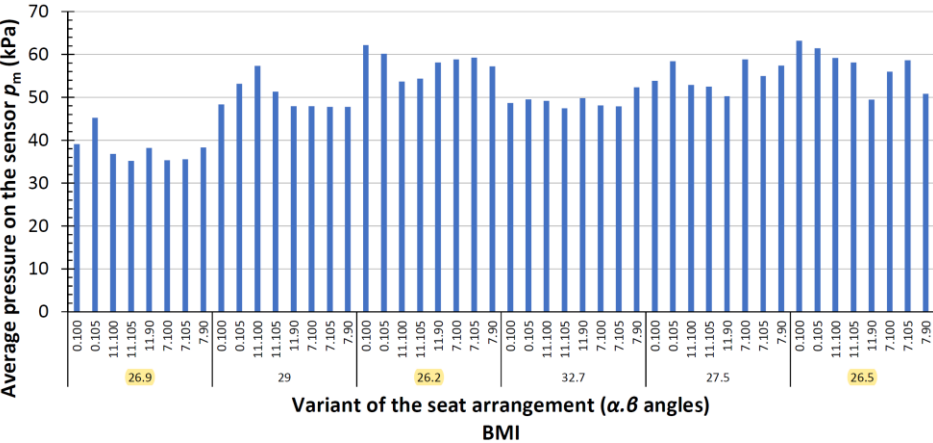

Figure 6. Average pressure on the sensor measured for men with different BMI interacting with various seat arrangements used

Women's BMI does not unambiguously affect the average pressure on the sensor. It can be observed in Figure 7. Similar BMIs (26.7 and 26.9) show different average pressures on the sensor. Figure 9 shows that women's active contact surface area varies at similar BMIs (26.7 and 26.9), so it can be concluded that BMI does not affect the active area.

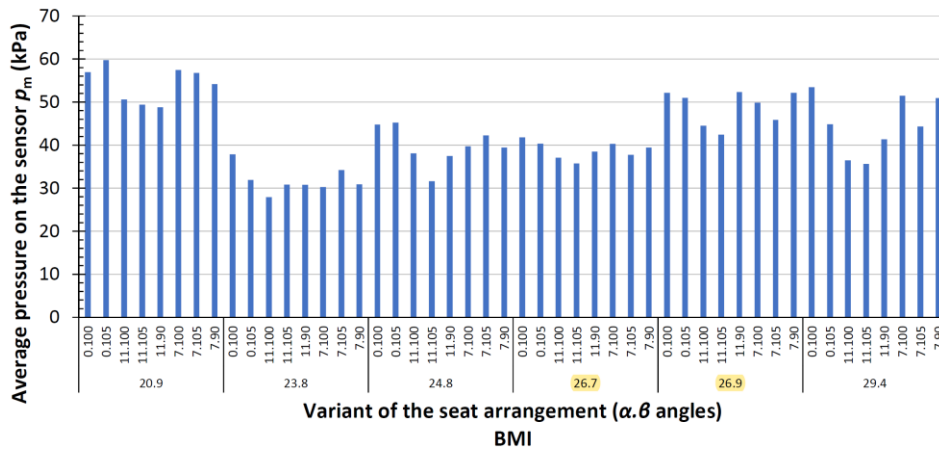

Figure 7. Average strain on the sensor for women with different BMI interacting with various configurations of the seat and backrest

Active surface. With similar BMIs (26.9; 26.2; 26.9) in men, the active area varies, so BMI does not affect the active area.

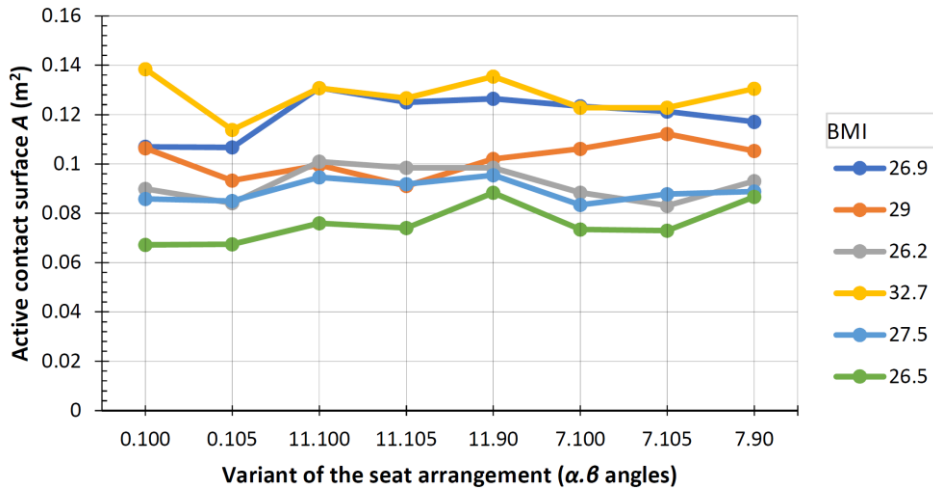

Figure 8. Active contact surface of men with different BMI interacting with various seat and back configurations

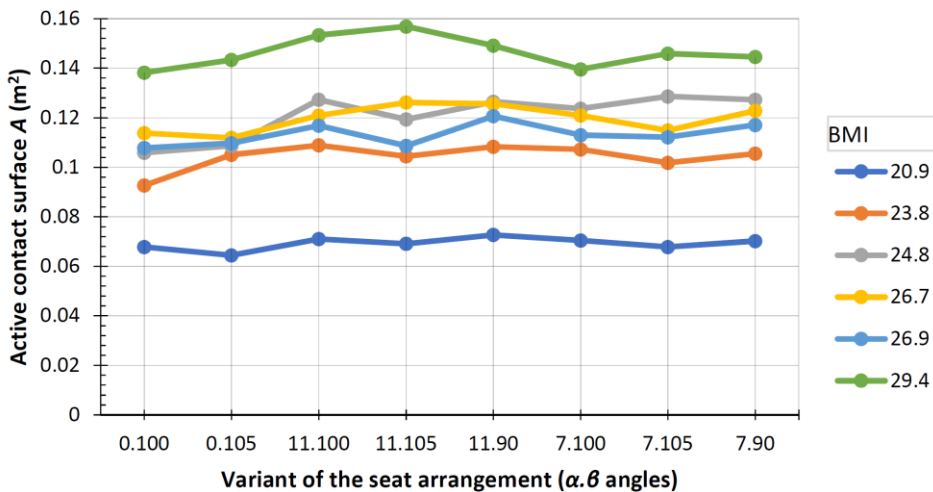

Figure 9. Active contact surface of women with different BMI interacting with various seat and back configurations

Study limitations. The discomfort coefficient (D) can yield erroneous high values when there are large average contact stresses on the sensors (p_m), a small contact area (A), and a low Seat Pressure Distribution (SPD) coefficient, which is characteristic of a thin person. It should be noted either that the discomfort coefficient method may give erroneous results for cases where the balanced and high stresses exceed the comfort level of the seating.

CONCLUSIONS

The work aims to verify the influence of BMI and gender on sitting comfort. The experimental setup included 6 men and 6 women, a sensory mat, and a model of adjustable sitting furniture. The results show an apparent influence of the furniture arrangement to the seat on the distribution of usable stresses and, thus, on the comfort and quality of use. The results of the D discomfort coefficient for nine combinations of the backrest and seat inclination were related to the anthropometric features of the examined group of people. The results indicate that anthropometric characteristics such as body mass index (BMI) and the user's gender influence objective seating comfort. The results are valuable in optimizing the geometry of furniture seats at the design stage.

The results make it possible to formulate the following observations:

1. Along with the increase in BMI, the value of the contact surface of the body with the furniture increased for both women and men surveyed. At the same time, higher BMI values indicated more favorable results of the SPD coefficient, i.e., a higher sense of comfort.
2. The most even stress distribution (SPD) and, at the same time, the most comfortable geometry of the seat and backrest were obtained: for women in the configurations, 11.90 and 11.100, which is 8% and 5%, respectively – concerning the reference position, and results obtained for men at variants 11.90 and 11.100, which are 6% and 5%, respectively, to the reference position.
3. Among all averaged measurements of the relationship between the discomfort coefficient D and the uniform stress distribution (SPD), similar associations were observed in men and women, indicating the position with the highest possible comfort in the geometry configuration seats support for systems 11.90 and 11.100.

Two additional general conclusions can be formulated after analysis of experimental results:

4. The results show a large diversity of results, which leads to the conclusion that the angle of inclination of the seat to the backrest should be selected individually for the anthropometric parameters of the users.
5. Sitting comfort and the quality of sitting furniture are closely related. The quality of all furniture is associated with positive user experiences and feedback. When individuals consistently report high levels of sitting comfort and satisfaction with a particular piece of furniture, it indicates a strong relationship between the quality of the furniture and the comfort experienced by users. The obtained results will help optimize the geometry of furniture seats at its design stage, increasing their quality.

Author Contributions

The research was initiated by KW, with equal contributions from ES and KW in the experimental design. ES performed the data analysis and prepared the initial draft of the manuscript, which included the literature review, graphs, and preliminary conclusions. KW and MS provided revisions to the main body of the manuscript. All authors actively participated in formulating the final conclusions. KW and ES made revisions during the review stage. The final version of the manuscript was approved by all authors. ES presented the study results at the 6th International Conference on Wood Composites Modification and Machining held in Kiry.

REFERENCES

1. De Looze, M. P., Kuijt-Evers, L. F. M., & Van Dieën, J. (2003). Sitting comfort and discomfort and the relationships with objective measures. *Ergonomics*, *46*(10), 985–997. <https://doi.org/10.1080/0014013031000121977>
2. Hitka, M., Naď, M., Langová, N., Gejdoš, M., Lizoňová, D., & Sydor, M. (2023). Designing Chairs For Users With High Body Weight. *BioResources*, *18*(3), 5309–5324. <https://doi.org/10.15376/biores.18.3.5309-5324>
3. Hitka, M., Štarchoň, P., Simanová, Ľ., Čuta, M., & Sydor, M. (2022). Dimensional Solution of Wooden Chairs for the Adult Bariatric Population of Slovakia: Observational Study. *Forests*, *13*(12), 2025. <https://doi.org/10.3390/f13122025>
4. *ISO 845:2006 Cellular plastics and rubbers—Determination of apparent density*. (2006). International Standard Organization.
5. *ISO 3386-1:1986 Polymeric materials, cellular flexible—Determination of stress-strain characteristics in compression—Part 1: Low-density materials*. (1986). International Standard Organization.
6. *ISO 8307:2018 Flexible cellular polymeric materials—Determination of resilience by ball rebound*. (2018a). International Standard Organization.
7. *ISO 8307:2018 Flexible cellular polymeric materials—Determination of resilience by ball rebound*. (2018b). International Standard Organization.
8. Matwiej, Ł., Wiaderek, K., & Łykowska, S. (2016). Analysis of stiffness, strength and ergonomics of upholstered furniture designer for outdoor use. *Annals of Warsaw University of Life Sciences – SGGW*, (95), 246–257.
9. Miklosik, A., Starchon, P., Kocisova, L., & Hitka, M. (2022). Anthropometric data importance in furniture design and marketing. *The Journal “Agriculture and Forestry,”* *68*(3). <https://doi.org/10.17707/AgricultForest.68.3.20>
10. Milivojevich, A., Stanciu, R., Russ, A., Blair, G., & Van Heumen, J. (2000). Investigating psychometric and body pressure distribution responses to automotive seating comfort. *Human Factors in 2000: Driving, Lighting, Seating Comfort, and Harmony in Vehicle Systems (SP-1539)*, 9. <https://doi.org/10.4271/2000-01-0626>
11. Rybczyński, W. (2016, August 23). Sitting Up. *The Paris Review*. <https://www.theparisreview.org/blog/2016/08/23/sitting-up/>
12. Seigler, M., Ahmadian, M., & Boggs, C. (2003). Validation of an indenter system for evaluating truck seat cushions. *Proceedings of the Institution of Mechanical Engineers, Part D: Journal of Automobile Engineering*, *217*(5), 343–348. <https://doi.org/10.1243/095440703321645052>
13. Smardzewski, J. (2015). *Furniture design*. Springer International Publishing AG. <https://doi.org/10.1007/978-3-319-19533-9>

14. Smardzewski, J., Jasińska, D., & Janus-Michalska, M. (2014). Structure and properties of composite seat with auxetic springs. *Composite Structures*, *113*, 354–361. <https://doi.org/10.1016/j.compstruct.2014.03.041>
15. Sydor, M., & Hitka, M. (2023). Chair's size design based on user height. *Biomimetics*, *8*(1), 57. <https://doi.org/10.3390/biomimetics8010057>
16. Tilley, A. R., & Dreyfuss, H. (Eds.). (2002). *The measure of man and woman: Human factors in design* (Rev. ed). Wiley.
17. Wiaderek, K. (2012). *Antropotechniczne modelowanie sztywności siedzisk mebli do wypoczynku / Anthropotechnical modeling of the seat stiffness in furniture for rest* [Dysertacja doktorska / PhD thesis]. Uniwersytet Przyrodniczy w Poznaniu. Poznań, Poland.
18. Wiaderek, K., Wiaderek, I., & Lange, J. (2019). Impact of upholstered furniture seat structures on the long-term use comfort. *Annals of Warsaw University of Life Sciences – SGGW*, (108), 39–44. <https://doi.org/10.5604/01.3001.0013.7678>

Streszczenie: *Wpływ ustawienia kąta siedziska i oparcia na jakość mebli do siedzenia: badania eksperymentalne.* Podstawową miarą jakości mebli do siedzenia jest komfort siedzenia. Komfort siedzenia określany jest w literaturze przez współczynnik dyskomfortu D , obliczany na podstawie wartości i rozkładu nacisków zmierzonych pomiędzy ciałem człowieka a „układem podparcia ciała” mebli do siedzenia. Celem badań była eksperymentalna weryfikacja wpływu wybranych cech antropometrycznych na komfort siedzenia. Badania przeprowadzono na 12 osobach z wykorzystaniem piezoelektrycznej maty sensorycznej oraz modelu regulowanego mebla do siedzenia. Zbadano, jak różne warianty pochylenia siedziska i oparcia wpływają na rozkład nacisków. Wynikiem badań są rozkłady nacisków oraz wartości współczynnika dyskomfortu D dla dziewięciu kombinacji nachylenia oparcia i siedziska odniesione do cech antropometrycznych badanej grupy osób. Analiza wyników wskazuje, że czynniki antropometryczne, takie jak wskaźnik masy ciała (BMI) i płeć użytkownika, znacząco wpływają na obiektywny komfort siedzenia. Spostrzeżenia te pomogą lepiej zoptymalizować wymiary mebli wypoczynkowych na etapie ich projektowania.

Corresponding author:

Krzysztof Wiaderek,
Wojska Polskiego 28,
60-637 Poznań, Poland
e-mail: krzysztof.wiaderek@up.poznan.pl
phone: +48 618487399