

Digital signal processing applied to the modernization of Polish Navy sonars

Jacek Marszal, Ph.D.
Gdansk University of Technology, Poland

ABSTRACT



The article presents the equipment and digital signal processing methods used for modernizing the Polish Navy's sonars. With the rapid advancement of electronic technologies and digital signal processing methods, electronic systems, including sonars, become obsolete very quickly. In the late 1990s a team of researchers of the Department of Marine Electronics Systems, Faculty of Electronics, Telecommunications and Informatics, Gdansk University of Technology, began work on modernizing existing sonar systems for the Polish Navy. As part of the effort, a methodology of sonar modernization was implemented involving a complete replacement of existing electronic components with newly designed ones by using bespoke systems and methods of digital signal processing. Large and expensive systems of ultrasound transducers and their dipping and stabilisation systems underwent necessary repairs but were otherwise left unchanged. As a result, between 2001 and 2014 the Gdansk University of Technology helped to modernize 30 sonars of different types.

Keywords: sonar; anti-submarine warfare; mine countermeasure; digital signal processing

INTRODUCTION

One of the main tasks of the Navy is to track submarines (Anti-Submarine Warfare -ASW) and search for and destroy naval mines (Mine Counter-Measure - MCM) [7]. This is done by specialised ships equipped with sonar systems. Submarines are tracked by using long-range low frequency sonars. ASW tasks are also performed by helicopters equipped with dipping sonar and sonobuoy systems [7]. Naval mines are searched for and destroyed by minesweepers and destroyers using high resolution short range sonar [7]. With the rapid advancement of electronic technologies and digital signal processing methods, electronic systems, including sonars which are a key element of ASW and MCM ships, become obsolete very quickly. While the problem affects a number of countries, it is most severe for countries which cannot afford frequent upgrades of their military equipment. In the first decade of this century the Polish Navy was operating ships which were built in the 1970s and 1980s. In view of this, in the late 1990s the Department of Marine Electronics Systems, Faculty of Electronics, Telecommunications and Informatics, Gdansk University of Technology, launched a project designed to modernize helicopter on-board anti-submarine warfare systems [48, 49]. The result was a modernized sonobuoy system with a new acoustic analyzer. Thanks to digital signal processing, the analyser can carry out spectral analysis of submarine-generated noise. The second helicopter ASW system to be modernized was dipping sonar OKA-2M/Z [27, 50]. Following its successful qualification test results in 2001, the OKA-2M/Z

modernization set the scene for more modernization of the Polish Navy's sonar systems.

In summary, between 2001 and 2014 the Gdansk University of Technology team modernized the total of 30 sonars of different types (dipping, towed array, hull-mounted with flat or cylindrical array, side scan) including 13 in ASW class and 17 in MCM class [28, 32, 37].

APPLICATION OF NEW TECHNOLOGIES

Modernized at the Gdansk University of Technology, the sonar systems operated by the Polish Navy were originally built in the 1970s and 1980s. The majority were Soviet designs built entirely in analogue technology, even with some of the transmitting equipment using high-power electron tubes. Following Poland's accession to NATO, the Polish Navy received two US Oliver Hazard Perry class frigates, built in 1978 and 1980. Even though the frigates' sonars were made in digital technology, it was the technology of the 1970s with sonars started by reading perforated tape and with signal processing computers for towed array sonar occupying entire fairly large cabins.

The main objective of the modernization was to design, build and replace all electronic systems and use modern digital systems in place of analogue or obsolete digital technology. The new equipment takes up significantly less space and uses significantly less power. Fig. 1 shows an example of the technology change in the case of the MG-89 sonar operator console.

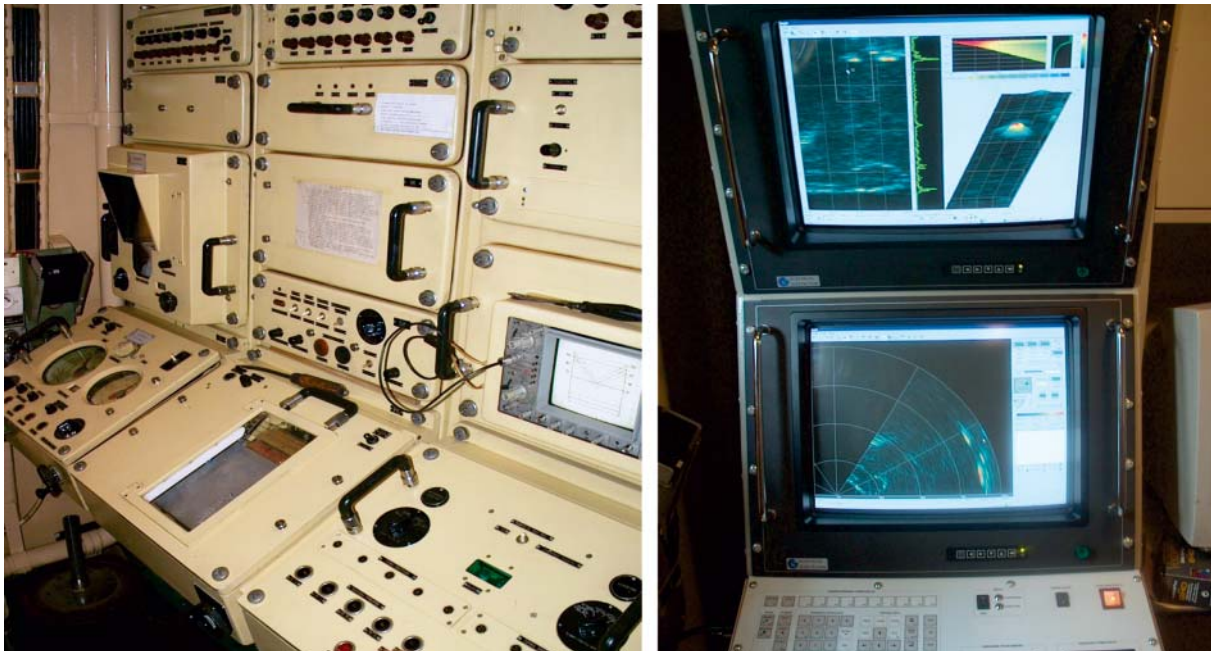

Fig. 1. Operator console of the MG-89 sonar before and after modernization

DIGITAL SIGNAL PROCESSING IN MODERNIZED SONARS

The world's first sonar using digital signal processing (DSP) was developed in 1960 [47]. Since then digital signal processing methods have been continuously improved to keep up with the demands of the new developments [5, 6, 10, 15, 16, 41, 54, 63]. Equipped with digital signal processing, sonars are now capable of delivering a wide range of new functions which were not available or difficult to achieve in the analogue technology or early digital technology, respectively. This applies in particular to the generation of sounding signals, beam-forming, pulse compression, filtration, detection and imaging of echo signals. The widespread use of sonars with multi-element ultrasonic transducers raises the bar for DSP processors in sonars even more than for DSP processors used in radar.

The modernization conducted at the Gdansk University of Technology involved not only the design and construction of entirely new systems using cutting-edge electronic technology, but also the use of broadband soundings signals and modern methods of digital signal processing. Although a number of the methods can be found in the literature, some of them had to be adapted to the specific parameters of the equipment. Part of the modernization at the Gdansk University of Technology included the development of new signal processing algorithms which are extensively described in many publications [11, 13, 20, 21, 22, 25, 26, 29, 30, 45, 48, 49, 50, 51, 52, 53, 54].

The design of modern sonar systems requires transducer equipment to generate broadband sounding signals and receiver equipment to use sophisticated methods of digital echo signal processing.

Generating sounding signals by using DDS

Direct Digital Synthesis (DDS) [3, 4] is a modern digital method for generating arbitrary signals. A DDS integrated circuit includes a control microprocessor, quartz frequency generator, programmable counter, Digital to Analogue Converter (DAC) and output analogue filter. When used in sonar transmitters, DDS offers new unlimited potential for sounding signal generation, starting from the simple "ping"

type signals, through "chirp" signals with linear (LFM) or hyperbolic (HFM) frequency modulation to any combination of the two.

The method was applied in all of the sonars modernized at the Gdansk University of Technology for generating new broadband sounding signals.

Multi-beam systems, which also use Rotational Directional Transmission (RDT) at the transmitting end, have to generate a number of simultaneous signals with phase shifts changing over time. The modernized MG-89DSP sonar uses multi-channel systems with multiple DDS systems. Thanks to the features of DDS, the shape of sounding pulses can now be optimized and helps to minimize the level of sounding signal side lobes, an effect which traditional technologies cannot possibly achieve [51].

Analogue - to - digital conversion in sonar systems

Once received by a multi-element ultrasonic transducer, echo signals of the modernized sonars are passed on to a multi-channel receiver for pre-processing. Signal pre-processing is conducted in the input analogue part of the receiver to ensure filtration and gain and to reduce the dynamics by applying time variable gain (TVG) [31]. Following this, echo signals undergo analogue - to - digital conversion in the multi-channel A/D converter to be then sent to specialized DSP processors. The process of analogue - to - digital conversion conducted in sonar systems must meet a number of conditions. Because the signals will be processed subsequent to the sampling for the purpose of time and space filtration, all channel sampling must be done synchronously in the same moments of time. To ensure the accurate timing of sampling, a number of independent converters are used rather than a single converter with input multiplexer, a common solution in other applications [46, 57]. The accuracy of the process depends on the input signal staying constant throughout the conversion time. The traditional approach is to use sample-hold systems but the more recent solutions use charge redistribution successive approximation analogue - to - digital converters. The converters are based on the Switched-Capacitor Circuits technology. The sample-hold process is at the core of their operation [12, 24].

Quadrature sampling

When we sample narrow-band signals with the frequency band B centred around the mid-channel frequency f_0 , we can significantly reduce the amount of data collected by using quadrature sampling, also known in the literature as second-order sampling or IQ sampling (**I**n-phase and **Q**uadrature-phase Sampling) [2, 8]. The quadrature sampling involves collecting pairs of signal samples which are $1/4$ of mid-channel frequency period apart. In practice the sampling frequency is four times the mid-channel frequency f_0 , and the time lapse between pairs of samples which are selected is not more than $1/B$. The first sample is treated as cophasal and the second as quadrature. Sequences of cophasal and quadrature samples are made. Because the spectra of cophasal and quadrature samples are within the sub-detection band from $-B/2$ to $+B/2$, the amount of data to be processed is significantly reduced. The amplitude spectra of sequences of cophasal and quadrature samples are identical and the complex spectra of the sequences are conjugate.

For broadband signals with their spectrum centred around the mid-channel frequency f_0 , and for narrowband signals with significant Doppler deviation, quadrature sampling introduces computational errors [1, 62]. Despite this, they can still be used; however, the results should be verified first.

Quadrature sampling is commonly used in modernized sonars. The application of broadband sounding signals meant that each narrowband approximation had to be analyzed for its effect on the accuracy of the results [52, 53]. That was the reason why traditional first-order sampling consistent with Nyquist theorem [45] was used in the modernization only in the case of broadband signal processing in passive SQR-19 sonar.

Digital Signal Processors

Digital signal processing involves a high number of mathematical operations on samples of the input signal. Digital Signal Processors are specialized processors whose architecture has been optimized to support fast computations which are typical in digital signal processing [23, 61]. Their main features include the so - called Harvard architecture with separate programme memory and data, pipelined execution of instructions and equipment implementation of the most typical signal processing operations such as FFT, FIR and IIR type filtrations and correlation.

Recent years have seen the emergence of new technologies which are in competition with specialized DSP processors. With the development of General Purpose Processors (GPPs), very fast GPPs (as an example Intel, Core i7 type) can successfully perform digital signal processing in a number of applications. Their prices and availability make them a real alternative to specialized DSPs. This is called a Commercial Off-the-Shelf (COTS) or COTS GPPs solution [40].

Programmable FPGA (**F**ield **P**rogrammable **G**ate **A**rrays) matrices are another growing possibility [40]. Their advantage is that they help with equipment miniaturization and use less power. The downside is that they are complicated to programme by using VHDL language (**V**ery-**H**igh-**S**peed **I**ntegrated **C**ircuits **H**ardware **D**escription **L**anguage). It is more difficult and takes more time than C or C++ programming, a language that can be used for programming classic DSPs. It is for these reasons that FPGAs are recommended for digital signal processing where size and power matter and in the case of larger scale manufacture.

For the above mentioned reasons, when modernizing the sonars, COTS GPPs processors were used as long as their

computational power was sufficient. As an example, the modernization of the helicopter on-board OKA sonar and the low frequency passive sonar with towed array SQR-19, involved the use of Industrial Computers, based on generally available processors.

In the case of modernizing active multi-beam sonars operating at higher frequencies, the Department of Marine Electronics Systems developed a multi-processor module based on DSPs produced by Texas Instruments TMS320C6713B. The module's architecture was optimized to ensure that it meets sonar signal processing requirements and can multiply the number of modules if needed to increase computational power [46, 57]. The module is easily programmable in the language C++ (alternatively to programming in the assembler) allowing fast implementation of algorithms pre-tested in the MATLAB environment [54].

SONAR DIGITAL SIGNAL PROCESSING ALGORITHMS

The basic tasks of digital signal processing in sonar systems include spatial filtering, also known as beam-forming, spectral analysis, matched filtration and correlation analysis [5, 6, 10, 15, 16, 41, 54, 63]. The next sub-sections are concerned with how these tasks are completed in the modernized sonars. There are different ways to implement spatial filtering algorithms, depending on array shape and the frequency and bandwidth of the signals.

FFT beam-forming for sonar with linear array

The array of the MG-89 sonar is a typical linear multi-element ultrasonic transducer with its elements spaced every half wavelength. The beam-forming applied for modernizing this sonar is the digital version of the phase beam-former, operating on complex samples produced as a result of quadrature sampling. Fig. 2 illustrates the principle of generating a single beam deflected from the acoustic axis by a given angle. The individual sections of the acoustic array receive echo signals whose phase shifts depend on the wave's angle of incidence. The direction of the beam pattern maximum is changed by changing the phase of signals received by the particular array elements. If the phase shifts are selected so as to ensure that signals at phase shifters' outputs generated by a wave incident from a specific direction have identical phases, the signal amplitude at adder output will be maximum. As a result, the beam pattern will turn by a given angle versus the array's acoustic axis. If a number of deflected beams are to be generated, these operations should be carried out for each beam with the right phase shifts that match the beam's desired angle of deflection. Generating 60 deflected beams requires $60 \times 36 = 2160$ phase shifters. We can halve this number by using the properties of phase shift symmetry.

The shifts of echo signal phases in the modernized sonar MG-89DSP are made digitally [46]. A sinusoidal signal represented by its quadrature samples has its phase shifted by changing the proportions between sine and cosine samples. The samples are multiplied by ratios whose value is equal to the sine and cosine from the desired phase shift. Next, the results of the multiplication are added which yields sine and cosine samples again but this time with a changed phase. Following this transformation, the sine and cosine samples are added. The result is one sine and one cosine sample in each sampling cycle.

The root of the sum of squares of these samples is proportional to the value of the relevant beam pattern and for the given wave incidence angle.

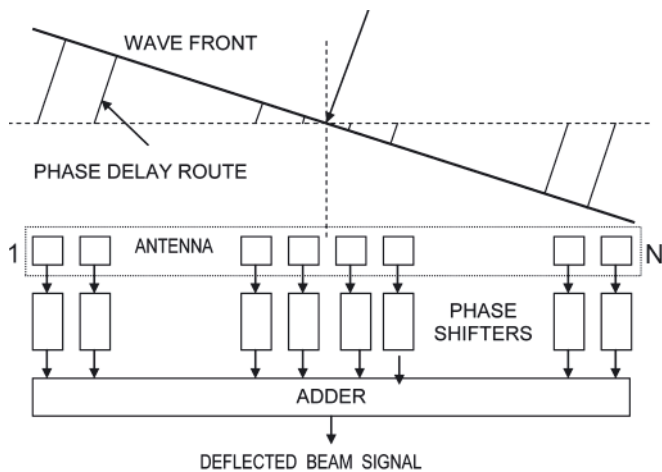

Fig. 2. Principle of generating a deflected beam

DSP operations can be significantly accelerated by applying the FFT algorithm to spatial frequencies [5, 6, 15, 54]. Because the application of the FFT algorithm involves a linear distribution of phase shifts, the result is a non-linear distribution of beam deflection angles. This makes it appropriate for fairly small beam deflection angles, typically not exceeding $\pm 30^\circ$. The application of the FFT algorithm goes hand in hand with the term of spatial frequencies, having to calculate the spectrum of the frequencies by using Fourier transformation. It can be seen that signal samples at array outputs have a sinusoidal shape of a specific frequency. The frequency depends on the wave incidence angle, hence the name-spatial frequency. If the signal samples undergo discrete Fourier transformation, the result will be a discrete spectrum. The lines of the spectrum are assigned to the individual angles of acoustic wave incidence on the array. To increase the number of beams and at the same time improve the sonar's angular resolution, the sequence of samples is supplemented with zero samples and the total number of samples should be equal to $n - \text{power of } 2$, which is a requirement of the FFT algorithm. This approach was used in the modernized MG-89DSP sonar's algorithm to increase the number of samples up to 128. Thanks to this the desired number of 61 beams was achieved in a 60° angular sector. In addition, the algorithm includes amplitude weighing to reduce the level of side lobes. Selected beam patterns of the beam-former in question are shown in Fig. 3. Amplitude weighing is done by multiplying the values of sine and cosine samples by weight ratios. The resulting theoretical side lobe level of receiving characteristics generated in the digital beam-former is -18 dB. It is only in the case of a 30° deflected beam that you can see a -16 dB side lobe.

Wideband beam-forming for passive sonar with towed linear array

Because passive sonars receive and process broadband signals of shipping noise with frequency bands comprising several octaves [9, 17, 18, 19], spatial signal processing in the sonars is much more complex than described in the previous section. The SQR-19PG sonar with towed linear array is an example. The band of frequencies received comprises more than 7 octaves ranging from 10 Hz to 1400 Hz, the linear array is 192 m long and the observation sector is 360° .

Passive sonar determines the orientation of incoming acoustic wave by using broadband beam-forming algorithms or algorithms for spatial spectrum estimation. In practice both methods are used, the classical beam-forming as the basic

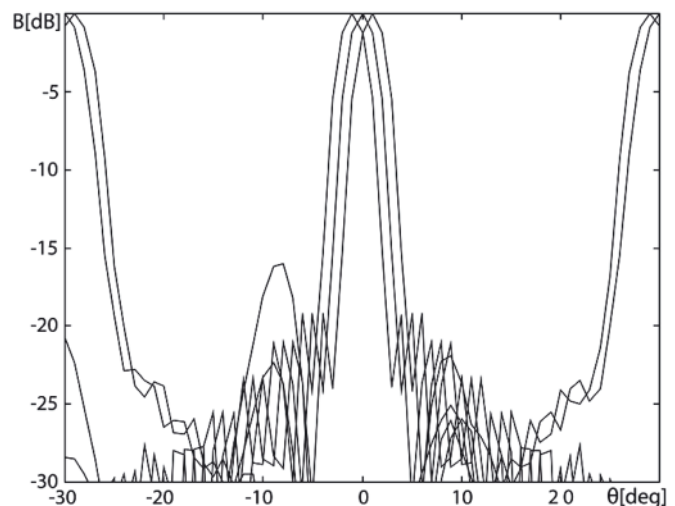

Fig. 3. Selected FFT beam-former patterns

mode of observation and spatial spectrum estimation for a more precise ranging.

Broadband beam-formers may be implemented in the domain of time or frequency. The idea of a broadband beam-former in the time domain is simpler. It directly implements signal delays to compensate for the difference between the paths of a wave coming to successive array elements from a specific direction (Fig. 2). To determine signal delays in the required resolution the number of signal samples is multiplied by using interpolation filtering. For this reason beam-formers operating in the time domain are called interpolation beam-formers. Because their principal computational effort is the consequence of interpolation, such beam-formers require a big amount of operating memory.

Beam-formers implemented in the frequency domain, on the other hand, have to have separate phase compensation for each spectral line of the received signals. As a result, when processing first begins, the signals are processed into spectral form by using FFT algorithms, and then each of the spectral lines is treated with narrowband phase beam-forming algorithms just as those described in the previous section. While the idea of broadband beam-forming in the frequency domain might seem more complex than beam-forming in the time domain, the effectiveness of FFT algorithms places lower demands on computer performance and operating memory capacity. In view of this, the modernized SQR-19PG sonar's wideband beam-former is implemented in the frequency domain.

The design of the SQR-19PG sonar array is divided into sections based on frequency bands which are one octave wide [45]. One exception is VLF, the lowest frequency band, which comprises as many as 4 octaves. The length of the individual sections and the relevant frequency bands are shown in Tab. 2. The particular bands in beam-former algorithms follow a different process resolution whilst maintaining an identical resolution to bandwidth ratio. The VLF band is an exception, because for frequencies below 88 Hz, due to the maximum array length and process resolution, its directional properties deteriorate.

Because of the design and principle of operation of sonar, a different beam width is obtained for each frequency line. Yet, the widths are identical in all frequency bands for lower, central and upper frequencies. Fig. 4 shows the central (non-deflected) array beam for lower, central and upper frequency of each band. In the other frequencies the widths of the central beam change almost linearly in the frequency function from 2.3° to 4.5° . In the VLF band, below 88 kHz, beam width increases significantly as frequency decreases. Fig. 5 shows central beam widths for very low frequencies.

Tab. 2. Frequency bands of the SQR-19PG beam-former

Band name	Section length [m]	Lower frequency limit [Hz]	Upper frequency limit [Hz]	Bandwidth [Hz]	Process resolution [Hz]
HF	24	701	1400	700	4
MF	48	351	700	350	2
LF	96	176	350	175	1
VLF	192	88 (10 [*])	175	175	0.5

*) The real lower cut-off frequency.

Beam width also increases significantly for high deflection angles [45, 54]. This effect typically occurs in all beam-formers with linear array and cannot be eliminated. Maximum widths occur when beams deflect by $\pm 90^\circ$, as shown in Fig. 6. For a maximum beam deflection, its width at -3 dB for the lower cut-off frequency is equal to 32° .

Depending on the beam-forming algorithm, the beams have a linear or non-linear distribution in the function of the deflection angle. When the FFT algorithm is used for spatial frequencies, adjacent beams intersect at a constant sensitivity level but the distribution of their directions is non-linear, as shown in Fig. 7. This is a feature of FFT beam-formers which becomes particularly relevant for large widths of the observation sector. If the beams are to have a linear distribution, the beam-former algorithm should use a non-linear phase shift distribution, which effectively means that the FFT algorithm cannot be used. The result will be a linear beam distribution as illustrated in Fig. 8. The computational effectiveness, however, is not as good as that of the FFT algorithm.

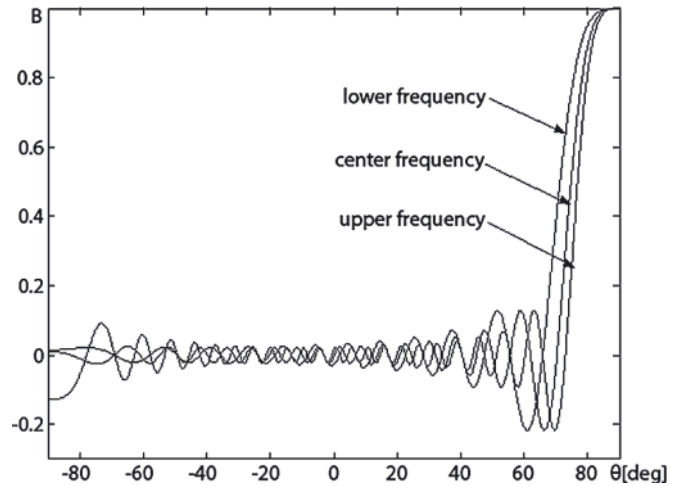

Fig. 6. Beam patterns for beams deflected by 90°

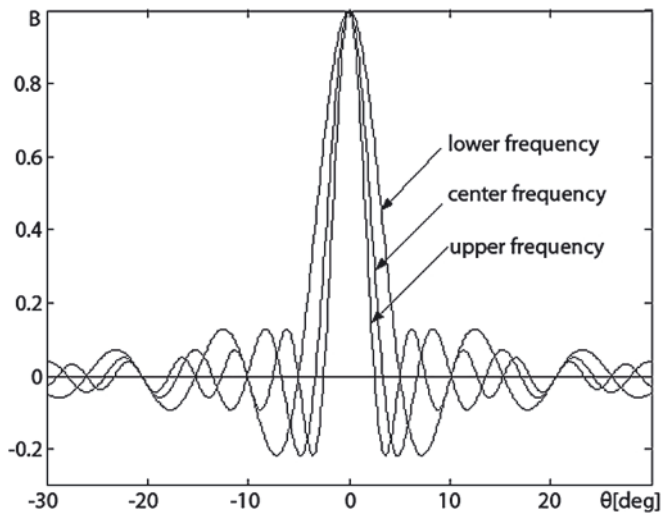

Fig. 4. Central sonar beams for lower, central and upper frequencies

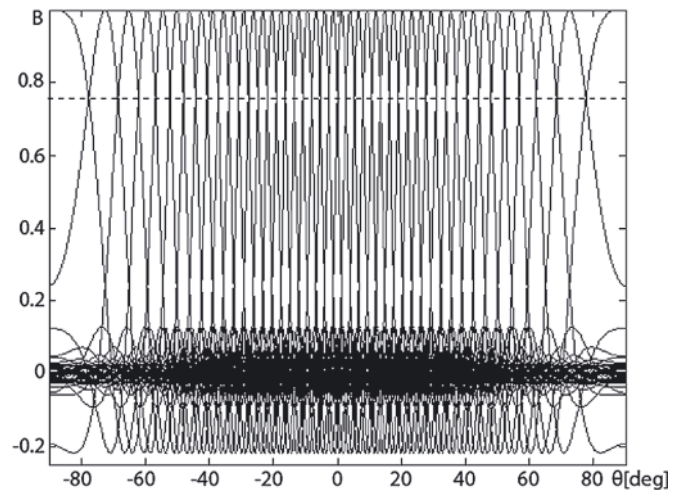

Fig. 7. Sonar beams intersecting at a constant sensitivity level

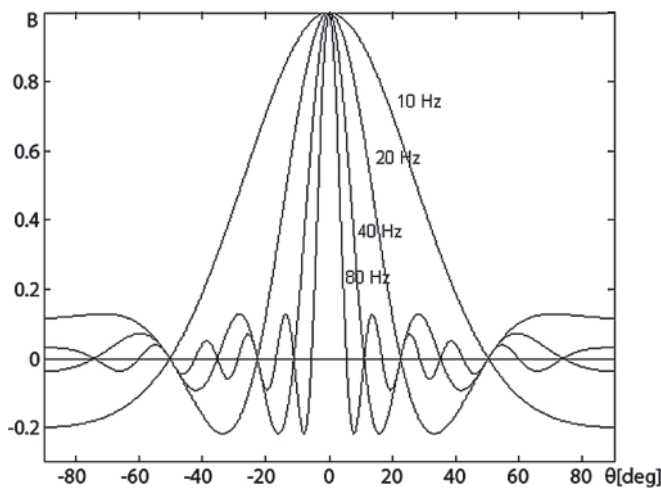

Fig. 5. Central beams for very low frequencies

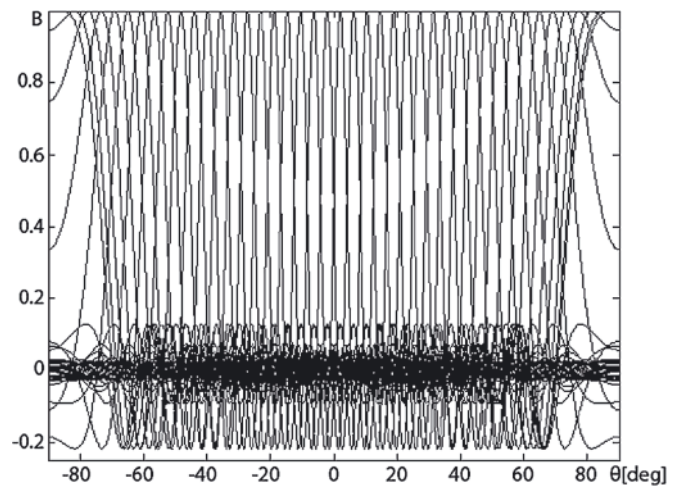

Fig. 8. Equally spaced sonar beams

The beam distribution in the modernized SQR-19PG sonar is linear. 91 beams are generated in the beam-former covering a 180° observation sector, equally spaced every 2° (the entire real observation sector is 360° with ambiguous left right direction). As a result, the narrowest beams intersect at -3 dB, while deflected beams intersect at systematically higher levels. In addition, the resulting imaging scale is uniform and the scale is given in integers, which helps with interpretation and ranging.

The beam-former algorithms applied in SQR-19PG modernization are very complex – the computations are made separately for each frequency line and the linear beam distribution meant that the FFT beam-forming algorithm could not be used. Despite that, because the frequencies of the signals were relatively low, the beam-former was implemented on an industrial general-purpose COTS computer.

Beam-forming for sonar with cylindrical array

MG-322DSP and SQS-56PG type, hull-mounted sonars have multi-element cylindrical arrays. For the purposes of horizontal beam forming, the cylindrical array may be replaced with a simpler circular array whose individual elements represent the columns of a real array. If the width of each column is significantly lower than wave length, the columns may be replaced with “point” hydrophones, to keep it simple.

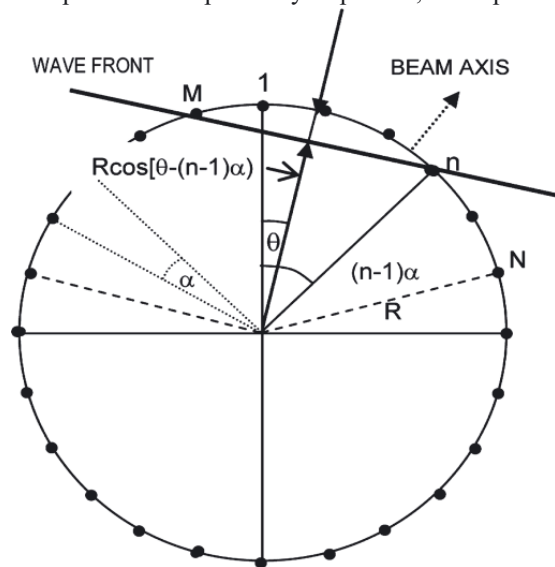

Fig. 9 shows such a simplified array model.

Fig. 9. Simplified cross-section of cylindrical array

The geometric centres of array elements are spaced at constant angular distances and the total number of columns is equal to M (30 for the MG-322DSP or 36 for the SQS-56PG sonar). A beam is generated in a cylinder sector which contains hydrophones marked from 1 to N in that figure. The next cylinder sector to generate the next beam is one array column from the previous sector. As a result, beams cover the complete angle of observation. The number of beams generated in such beam-formers is identical to the number of array columns. If the neighbouring beams are to intersect at -3 dB with regard to the acoustic axis level, then beam width is equal to angle α marked in Fig. 9. Beam-forming in a cylindrical array involves compensating for signal delays. They are the result of the different distances covered by waves coming to the array columns in a sector [5, 41, 54].

Unlike in the above described method, the modernized sonar with cylindrical array has a higher number of beams. In the case of the MG-322 DSP sonar a cylinder sector containing

11 columns generates 3 beams. The central column's centre of sectors determines the direction of the central beam. The axes of two neighbouring beams (left and right) are deflected from the central axis centre by -4° and +4°. The objective of phase compensation, in this case, is, for the acoustic wave incident on the sector's central column, to generate identical phase shifts of all signals from the outputs of the array's 11 columns. In the case of beams deflected by -4° and +4°, identical phase shifts have signals caused by acoustic wave incident on the array's central column at -4° or +4°, respectively, with regard to perpendicular direction towards the central column. This is applied to the other cylinder sectors, each moved by one column, until 90 beams are generated, spaced every 4°. By using a similar method, the SQS-56PG sonar's 36 columns generate 72 beams, spaced every 5°.

In a multi-beam spatial filter, phase compensation is done by multiplying cophasal and quadrature samples by numerical ratios. The operations produce real and imaginary parts of signals of sonar receiving beams. A complete phase compensation in the spatial filter occurs for the mid-channel frequency of sounding signal spectrum. This approximation has a minor effect on detection conditions, causing a slight increase in side lobe level of the patterns of the individual beams [52, 53].

The objective of the numerical ratios is for signal sample multiplication to perform amplitude weighing as well as phase shifts. This is to reduce the final side lobe level. A weighing “cosine on a pedestal” function was used with pedestal value equal to 0.4. Thanks to this, the resulting side lobe level was reduced to -18 dB. Fig. 10 shows the beam pattern of a single beam in the modernized MG-322DSP sonar. Fig. 11 shows the layout of all of the 90 receiving beams.

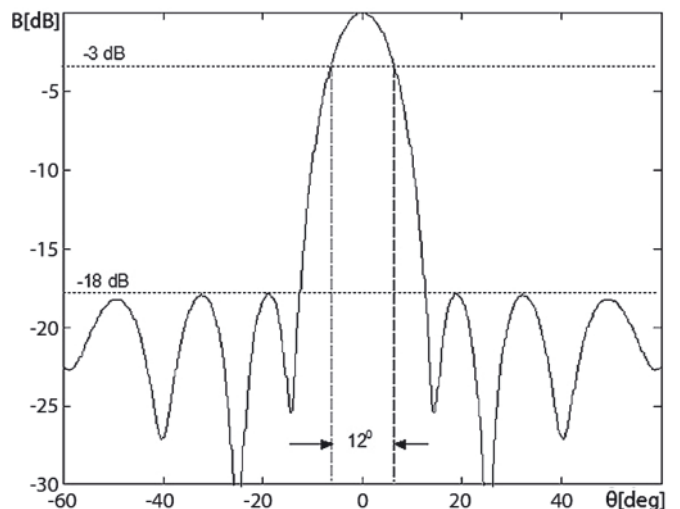

Fig. 10. Beam pattern of receiving beam of the MG-322-DSP sonar

Matched filtering in time domain

In many of the modernized sonars the used signals have linear or hyperbolic frequency modulation with a high product of time duration and frequency bandwidth. If used in combination with matched filtering, the signals may improve the signal-to-noise ratio and detection range, which is particularly important for long range sonar. Digital processing methods offer several different ways of implementing matched filtering. The simplest and most computationally effective method is implemented in the frequency domain by using FFT algorithms. Echo signal samples from the entire range of distances (from the moment a sounding signal is sent until the echo signal is received from the end of the range) are converted into spectral form using FFT. The resulting complex spectral lines are multiplied by

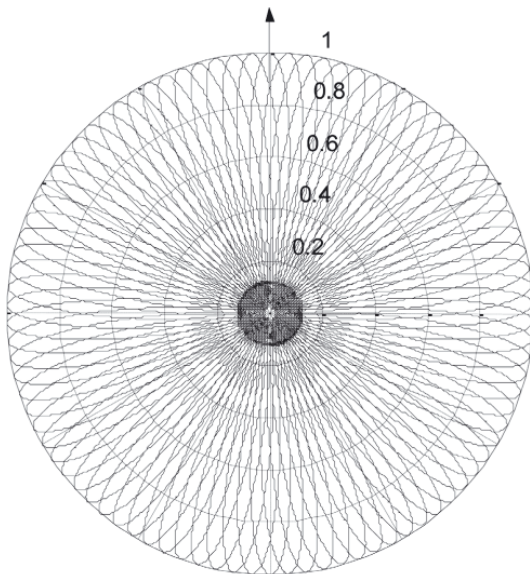

Fig. 11. Layout of receiving beams of the MG-322DSP sonar

complex values of conjugate spectral lines of the sounding signal pattern. Reverse FFT gives the result of echo signal matched filtering. There is a major downside to this method, however, because the computation does not start until echo signal samples from the entire range are collected. In the case of sonar with a range of some fifty kilometres it may take up to a minute before observation results are known. For this reason it is advisable to use a different method which will allow ongoing detection as echo signals return. This can be done by using correlational detection in the time domain or the wavelet transform method [54, 58].

In the modernized MG-322DSP sonar, cophasal and quadrature signals from 90 outputs of a multi-beam spatial filter undergo correlational digital detection in a block of signal processors [57]. Correlational detection is made on complex signal samples from the outputs of the multi-beam spatial filter with cophasal samples treated as real and quadrature samples taken as imaginary. Processors compute in real time the functions of echo signal correlations. The number of complex echo signal samples depends on the sounding pulse duration and ranges from 213 samples for a 50 ms pulse to 6801 samples for a 1.6 s pulse. In order to determine one correlation signal sample, for each of the 90 beams we carry out from 213 complex multiplications and 212 summations of complex numbers (for a 50 ms pulse) to 6801 complex multiplications and 6800 summations of complex numbers (for a 1.6 s pulse). The operations take less than 230 μ s. Thanks to the used solution, we can have a running display of signals after detection from 90 beams as echo signals are coming in.

Following correlational detection, the sounding signal is compressed in time by the product of bandwidth and signal duration. Fig. 12 shows an enlarged shape of a sounding pulse after correlational detection for an LFM sounding signal and bandwidth of 800 Hz. The duration of the sounding pulse is 1s, i.e. 800 times longer.

Method for improving multi-beam sonar bearing accuracy

When a target is detected, operators of the modernized sonars may switch on the tracking mode, which further improves target positioning accuracy. To that end algorithms were developed at the Gdansk University of Technology whose origins go back to the mono-pulse method known from analogue technology [54, 59, 60].

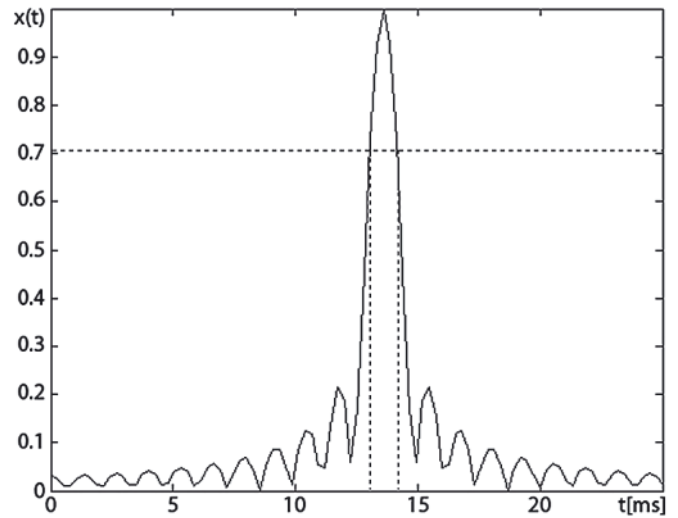

Fig. 12. LFM pulse after correlational detection (800 Hz deviation)

Tracking can only be switched - on once the target is marked with a special marker. Placing a marker on a beam selects that particular beam and two neighbouring beams. The three beams are searched for signal maxima in the time interval around the marker. Next, three sequences are made of quadrature samples collected from array elements which generate the selected beams. The sequences are contained in double the duration of echo from the object being tracked. The samples are sent to the input of the tracking beam-former. It generates three beams: central, deflected to the left and deflected to the right. The beam-former input has three matched filters. Their signals are used to control beam rotation. The amplitudes of signals from two deflected beams are compared. In traditional systems if the signal from the left beam is bigger than the signal from the right beam, the beam-former deflects all beams to the left. Otherwise, it does so to the right. The target tracking beam-former deflects beams by changing the values of beam-former ratios. These are multiplied by complex signal samples to obtain equal signals in both beams. Beam deflection will continue until the signals of both beams are equal, i.e. when the absolute difference between them reaches minimum value. The angle at which signal difference reaches minimum value is the wave arrival angle. By tracking the signal from the central beam, we can improve beam control. Beams move at a step of 0.1° , which ensures the theoretical accuracy of angle measurement which is equal to the value of the step. This complex procedure is replaced with an algorithm

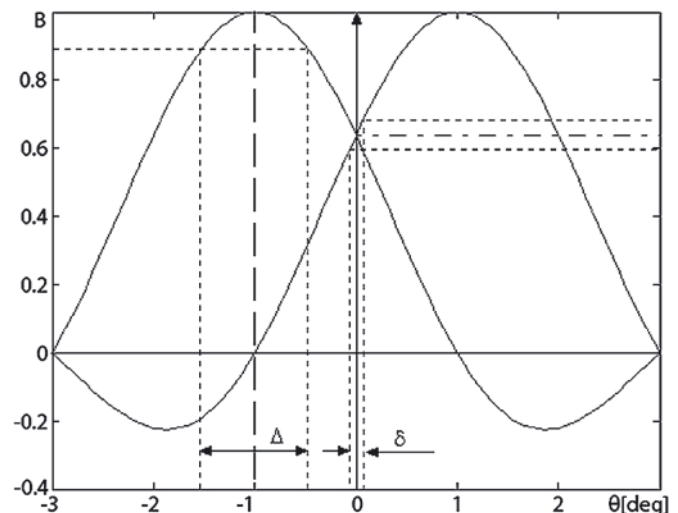

Fig. 13. Error in determining the direction using the method for equalizing signals from two beams

for determining direction based on the proportion between signals from neighbouring beams, a method developed at the Gdansk University of Technology [21, 22].

The practical accuracy of bearing depends on the signal-to-noise ratio which has an effect on the error in signal amplitude identification. Fig. 13 explains how an amplitude measurement error affects the angle measurement error. The figure also shows why the same amplitude measurement error generates a bigger error in direction when the beam pattern is used.

MODERN VISUALIZATION METHODS

The modernized sonars were equipped with modern and ergonomic displays with colour screen monitors, a wide range of imaging, display of settings, external data, messages, cursors, etc., which make up the so-called Man Machine Interface (MMI) [14, 42, 43, 44]. Sonar settings are simplified with new and modified settings supported with ergonomic pictograms and messages. Improvements were made to data transmission

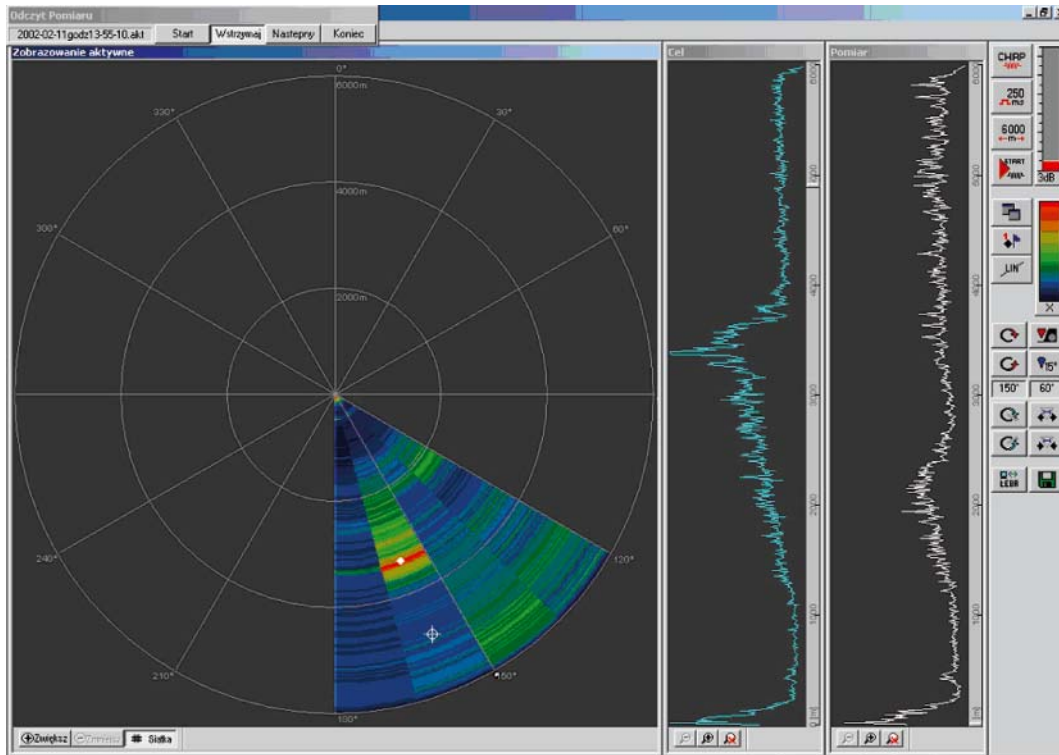

Fig. 14. Panoramic (PPI) imaging in the OKA-2M/Z sonar in active mode

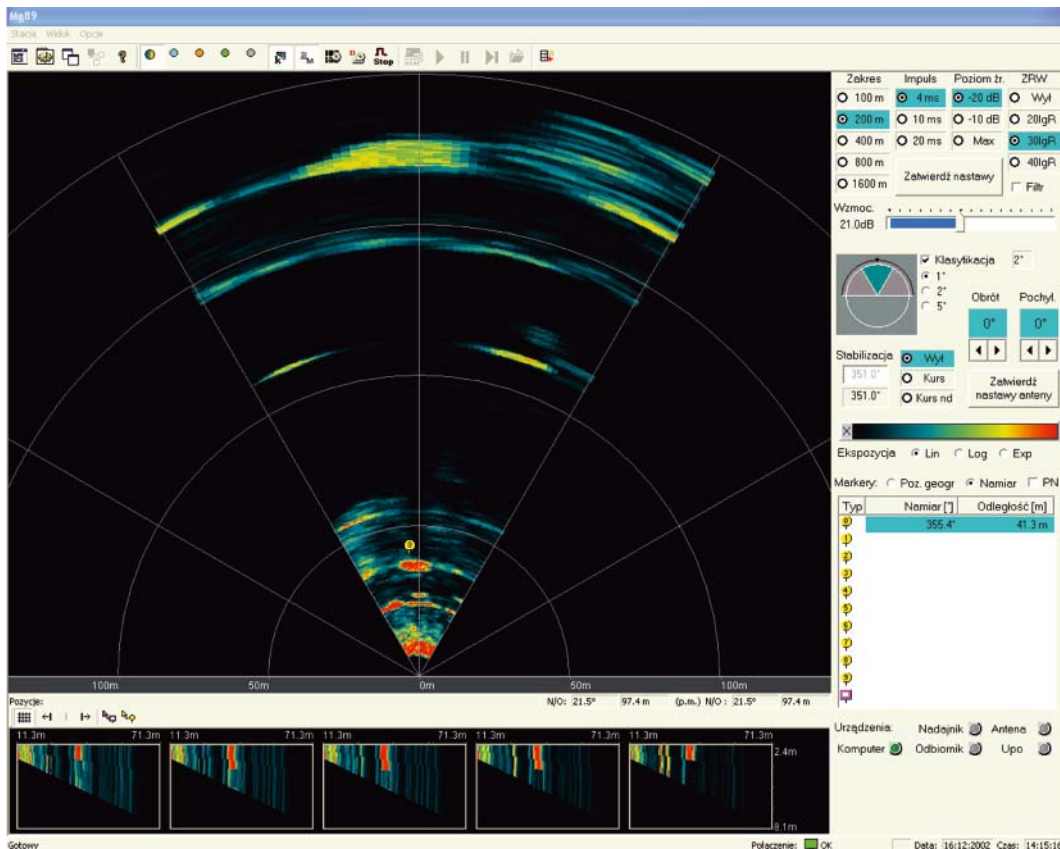

Fig. 15. Basic imaging in the mine counter-measure sonar MG-89DPS

between sonar elements and to computer methods for recording signals and images. The new visualization methods help operators with target detection, classification and tracking. Examples of visualizations in the modernized sonars are shown in Fig. 14 ÷ 18.

CONCLUSIONS

Although it has been somewhat constrained by the existing ultrasonic transducers, the modernization has in fact led to the development of completely new sonar systems. The new

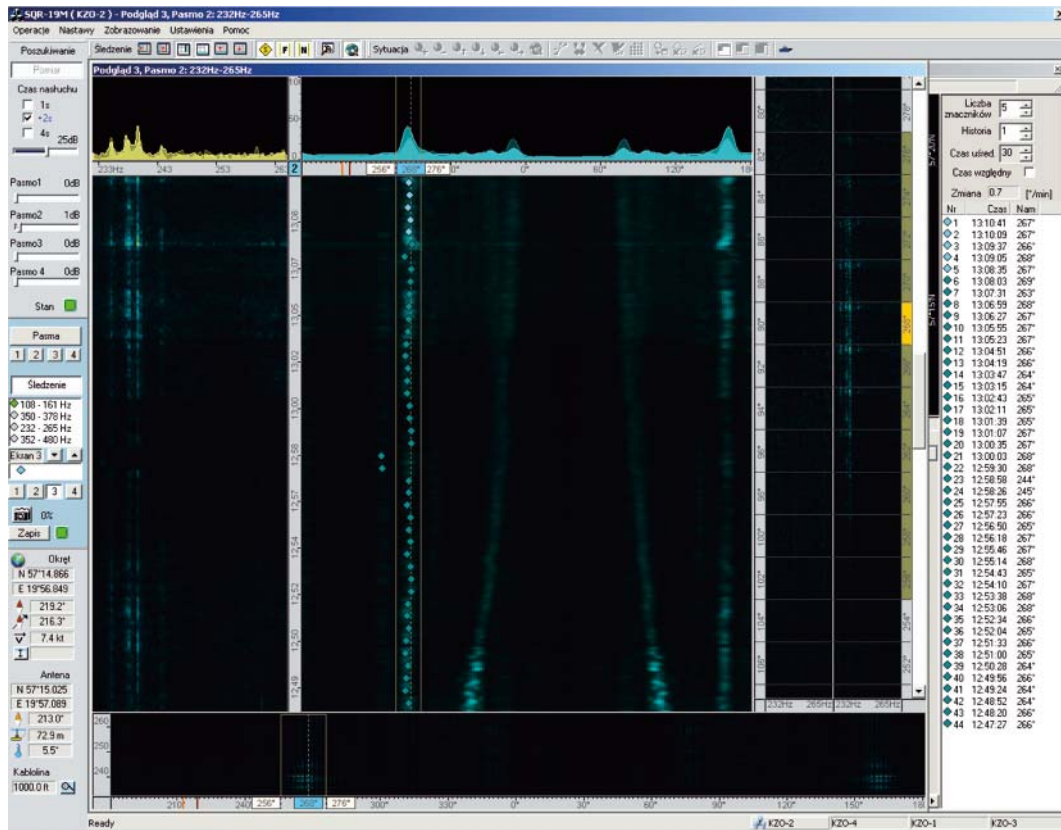

Fig. 16. Automatic tracking of Kobben-type submarine by using passive sonar with the towed array SQR-19PG

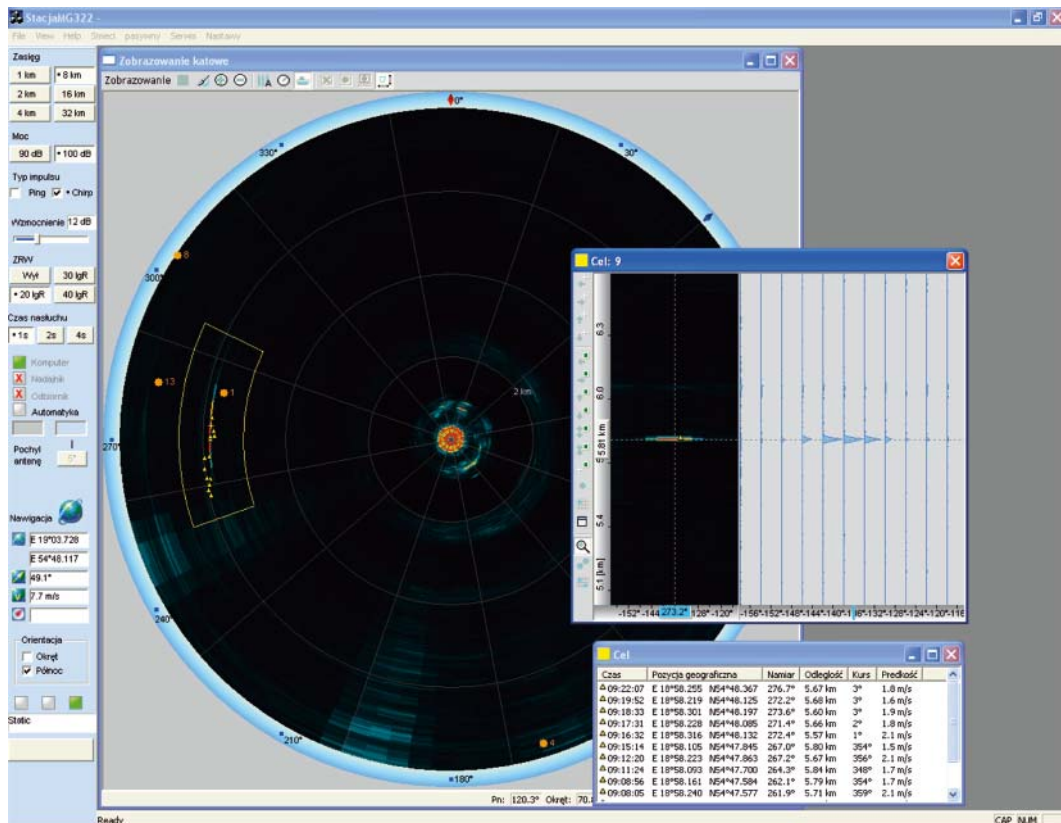

Fig. 17. Tracking of Kilo-type submarine by using the modernized sonar with the cylindrical hull-mounted array MG-322DSP

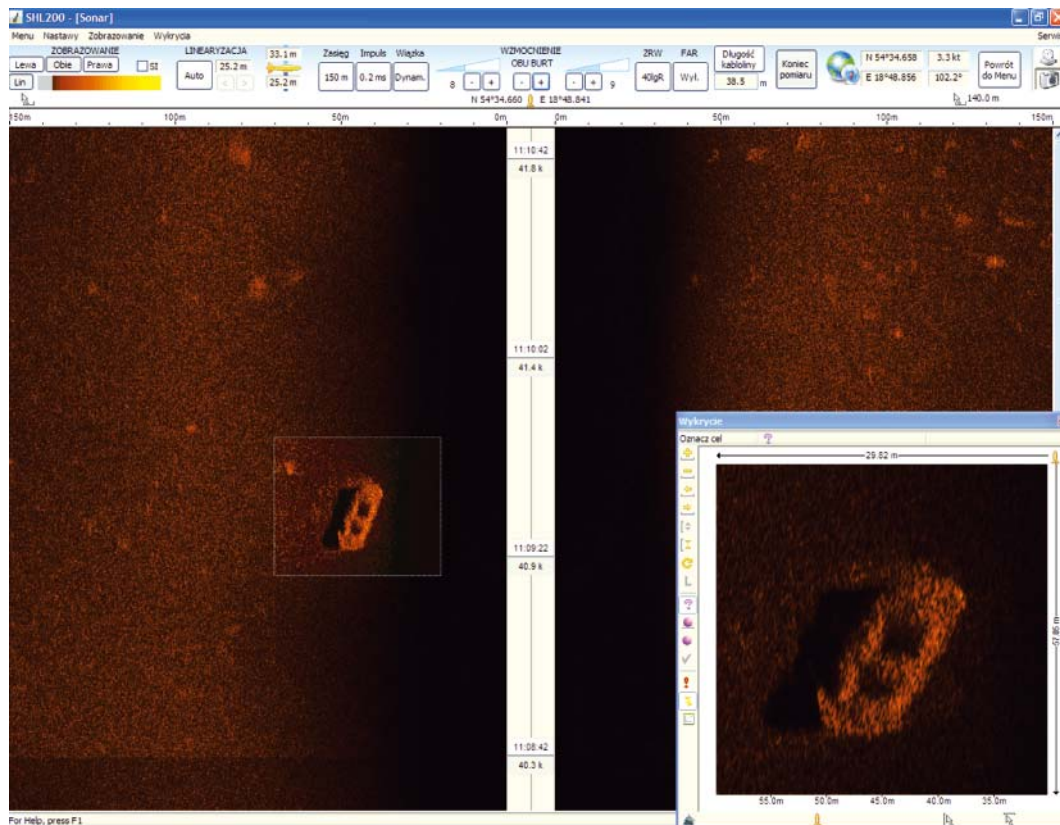

Fig. 18. Determining shipwreck location by using the side scan sonar SHL-200DSP

signal processing methods combined with new system solutions have effectively improved the parameters of the sonars and, as a consequence, the ships' warfare capability.

What needs to be emphasized is that the approach is very cost efficient. The costs of the modernization represent some 20 % of the cost to purchase new sonars with similar parameters.

Apart from conducting modernization projects, in recent years the team of the Department of Marine Electronic Systems at the Gdansk University of Technology has been working on developing new hydro-acoustic systems. The new designs include a unique silent sonar, which is difficult to be detected by enemy intercepting systems [33, 34, 35, 36, 38, 39, 55, 56].

With the new knowledge and experience gained by the Department of Marine Electronic Systems, the researchers are able to design and build other modern hydro-acoustic systems for naval applications, including multi-frequency and high resolution systems and sonars with synthetic aperture.

BIBLIOGRAPHY

1. Brown J. L. Jr: *On the error in reconstructing a non-bandlimited function by means of the bandpass sampling theorem*. Journal Math. Anal. Applied, Vol. 18. 1967, pp. 75-84, Erratum - Vol. 21.1968, p. 699
2. Brown J. L. Jr: *On quadrature sampling of bandpass signals*. IEEE Transactions on Aerospace and Electronic Systems, vol. 15, No. 3, 1979, pp. 366-371
3. Cordesses L.: *Direct digital synthesis: a tool for periodic wave generation (Part 1)*. IEE Signal Processing Magazine, July 2004, pp. 50-54
4. Cordesses L.: *Direct digital synthesis: a tool for periodic wave generation (Part 2)*. IEE Signal Processing Magazine, September 2004, pp. 11-112
5. Curtis T. E.: Ward R. J., *Digital beamforming for sonar systems*. IEE Proceedings Part F, Communications, Radar and Signal Processing, Vol. 127, No. 4, 1980
6. Curtis T.: *Sonar technology - past and current*. Curtis Technology (UK) Ltd, 2004., <http://www.curtistech.co.uk/papers/sonarpc.pdf>
7. Friedman N.: *The naval institute guide to world naval weapon systems*. Naval Institute Press, 2006
8. Grace O. D., Pitt S. D.: *Quadrature sampling of high frequency waveforms*. Journal of Acoustical Society of America, Vol. 44, pp. 1432-1436, 1968
9. Grelowska G., Kozaczka E., Kozaczka S., Szymczak W., *Underwater Noise Generated by a Small Ship in the Shallow Sea*, Archives of Acoustics, Vol. 38, No 3, 2013, pp. 351-356
10. Hodges R. P.: *Underwater Acoustics: Analysis, Design, and Performance of Sonar*. Wiley, 2010
11. Jedel A., Kilan L., Marszał J., Ostrowski Z., Salamon R.: *Dynamic control of the receiving beam horizontal cross-section in the side scan sonar*. Hydroacoustics, Vol. 8, 2005, pp. 69-76
12. Kester W.: *Data conversion handbook (Analog Devices)*. Elsevier/Newnes, 2005
13. Kilian L., Marszał J.: *Analyse der Richtwirkung einer linearen Matrix von Hydrofonen für determinierte Breitbandesignale*, Fortschritte der Akustik DAGA'93, Teil A, Frankfurt am Main 1993, pp. 430-433
14. Kilian L., Raganowicz A., Sidorko T.: *Visualization forms in MCM side scan sonar*. Hydroacoustics, Vol. 13, 2010, pp. 119-126
15. Knight W. C., Pridham R. G., Kay S. M.: *Digital signal processing for sonar*. Proceedings of the IEEE, Vol. 69, No. 11, 1981
16. Kolev N.: *Sonar systems*. InTech, 2011
17. Kozaczka E., Grelowska G.: *Shipping noise*. Archives of Acoustics, Vol. 29, No 2, 2004, pp. 169-176
18. Kozaczka E., Domagalski J., Grelowska G., Gloza I.: *Identification of hydro-acoustic waves emitted from floating units during mooring tests*, Polish Maritime Research, Vol. 14, No 4(54), 2007, pp. 40-46
19. Kozaczka E., Grelowska G.: *Shipping low frequency noise and its propagation in shallow water*, Acta Physica Polonica A, Vol. 119, No 6A, 2011, pp. 1009-1012

20. Leśniak W., Marszał J., Salamon R., Rudnicki M., Schmidt A.: *Digital mono-pulse method in cylindrical antenna*. Archives of Acoustics, Vol. 31, No. 4 (sup.), 2006, pp. 357-363
21. Leśniak W., Marszał J., Salamon R., Zachariasz K., Schmidt J.: *Method for improving multibeam sonar bearing accuracy*. Hydroacoustics, Vol. 12, 2009, pp. 99-108
22. Leśniak W., Rudnicki M.: *Improving the accuracy of bearing in active sonar with cylindrical array using spectrum estimation*. Hydroacoustics, Vol. 16, 2013, pp. 159-166.
23. Lyons R. G.: *Understanding digital signal processing*. 2-nd Edition. Prentice Hall, 2004
24. Maloberti F.: *Data converters*. Springer, 2008
25. Marszał J.: *Directivity pattern of active sonars with wideband signals*. Acoustical Imaging, Vol. 19, Springer, 1992, pp. 915-919
26. Marszał J., Zachariasz K.: *Richtwirkung des aktiven Sonars für Sendesignale mit schäfer Autokorrelationsfunktion*. Fortschritte der Akustik DAGA 93, Teil A, Frankfurt am Main 1993, pp. 434-437
27. Marszał J., Jedel A., Ostrowski Z.: *Small antenna for a dipping sonar*. Hydroacoustics, Vol. 4, 2001, pp. 169-172
28. Marszał J., Salamon R., Stepnowski A.: *Military sonar upgrading methods developed at Gdansk University of Technology*. Proc. IEEE Oceans'05 Europe Conference, Brest 2005. [Electronic document CD-ROM], pp. 489-494
29. Marszał J., Leśniak W., Salamon R., Jedel A., Zachariasz K.: *Passive sonar with cylindrical array*. Archives of Acoustics, Vol. 31, No. 4 (Sup.), 2006, pp. 365 - 371
30. Marszał J., Leśniak W., Salamon R., Schmidt J.: *Electronic stabilization of beams in sonar with cylindrical array*. Hydroacoustics, Vol. 9, 2006, pp. 119-124
31. Marszał J., Ostrowski Z., Schmidt J., Kilian L., Jedel A., Schmidt A.: *Time variable gain for long range sonar with chirp sounding signal*. Hydroacoustics, Vol. 10, 2007, pp. 117-122
32. Marszał J., Schmidt J., Salamon R., Kilian L., Raganowicz A., Zachariasz K., Ostrowski Z., Jedel A., Rudnicki M., Sidorko T., Schmidt A., Leśniak W.: *Modernization of ASW sonar SQS-56 at Gdansk University of Technology*. Hydroacoustics, Vol. 13, 2010, pp. 191-196
33. Marszał J., Salamon R., Zachariasz K., Schmidt A.: *Doppler Effect in the CWFm sonar*. Hydroacoustics Vol. 14, 2011, pp. 157-164
34. Marszał J., Salamon R., Kilian L.: *Application of maximum length sequences in silent sonar*. Hydroacoustics, Vol. 15, 2012, pp. 143-152
35. Marszał J., Salamon R.: *Distance measurement errors in Silent FM-CW sonar with matched filtering*. Metrology and Measurement Systems, Vol. XIX, No. 2, 2012, pp. 321-332
36. Marszał J., Salamon R.: *Silent sonar for maritime security applications*. Proceedings of Meetings on Acoustics, Acoustical Society of America, Vol. 17, 070082, 2013
37. Marszał J.: *Implementation of Contemporary Technologies in the Modernization of Naval Sonars*. Hydroacoustics, Vol. 16, 2013, pp. 167-180
38. Marszał J., Salamon R.: *Detection Range of Intercept Sonar for CWFm Signals*, Archives of Acoustics, Vol. 39, 2014, No 2
39. Marszał J.: *Experimental Investigation of Silent Sonar*, Archives of Acoustics, Vol. 39, 2014, No 1, pp. 103-115
40. McHale J.: *Radar signal processing upgrades use embedded COTS hardware*. Military Embedded Systems, Vol. 8 No. 1, 2012, pp. 30-35
41. Nielsen R. O.: *Sonar signal processing*. Artech House, 1991
42. Raganowicz A., Salamon R., Rudnicki M., Kilian L.: *Visual representation of the effects of spatial and frequency filters applied in passive sonars*. Hydroacoustics, Vol. 4, 2001, pp. 281-284
43. Raganowicz A., Kilian L., Ostrowski Z.: *Special forms of echo visual representation in an ahead looking sonar*. Hydroacoustics. Vol. 5/6, 2003, pp. 47-52
44. Raganowicz A., Kilian L., Marszał J., Ostrowski Z., Schmidt A.: *Visualisation forms in passive sonar with towed array*. Archives of Acoustics, Vol. 31, No. 4 (Sup.), 2006, pp. 373 - 378
45. Rudnicki M., Raganowicz A., Schmidt J.: *Acoustic signal processing in passive sonar system with towed array*. Hydroacoustics, Vol. 11, 2008, pp. 329-338
46. Rudnicki M., Schmidt J., Schmidt A., Leśniak W.: *Acoustic processor of the mine countermeasure sonar*. Hydroacoustics, Vol. 15, 2012, pp. 179-186
47. Rudnik P.: *Small signal detection in the DIMUS array*. Journal of Acoustical Society of America, Vol. 32, No. 7, pp. 871-877, 1960
48. Salamon R., Marszał J., Kilian L., Jedel A.: *New signal processing in a passive sonar with gradient antenna*. Hydroacoustics, Vol. 3, 2000, pp. 129-134
49. Salamon R., Marszał J., Raganowicz A., Rudnicki M.: *Application of Fourier transformation in a passive sonar with gradient hydrophones*. Proc. of the Fifth European Conference on Underwater Acoustics. Proceedings of fifth European Conference on Underwater Acoustics, ECUA 2000, Lyon, pp. 1115-1120
50. Salamon R., Marszał J., Rudnicki M.: *Underwater acoustic system with small antenna for the detection and bearing of sound sources*. Proceedings of 17th International Congress on Acoustics, Rome 2001, Vol. II [Electronic document] pp. 1-2
51. Salamon R., Marszał J.: *Optimising the sounding pulse of the rotational directional transmission sonar*. Acta Acustica united with Acustica, Vol. 88, 2002, pp. 666-669
52. Salamon R., Rudnicki M., Schmidt J.: *General analysis of broadband signal spatial filtration*. Hydroacoustics, Vol. 5/6, 2003, pp. 251-260
53. Salamon R., Marszał J., Leśniak W.: *Broadband sonar with a cylindrical antenna*. Acta Acustica united with Acustica, Vol. 92, 2006, pp. 153-155
54. Salamon, R.: *Sonar systems*. [in Polish], Gdanskie Towarzystwo Naukowe, Gdansk 2006
55. Salamon R., Marszał J., Schmidt J., Rudnicki M.: *Silent sonar with matched filtration*. Hydroacoustics, Vol. 14, 2011, pp. 199-208
56. Salamon R., Marszał J.: *Estimating Intercept Range of Silent Sonar*, in Hydroacoustics of Shallow Water edited by E. Kozaczka, G. Grelowska, Polish Academy of Sciences Institute of Fundamental Technological Research, Warszawa, 2013, pp. 139-158
57. Schmidt J., Schmidt A.: *Implementation of the digital receiver in multibeam long-range sonar*, Hydroacoustics, Vol. 16, 2013, pp. 203-210
58. Schwenke R. W.: *Sensitivity analysis of an estimator-correlator for the detection of spread targets with multiple discrete highlights*. Technical Report No. TR 00-006, The Pennsylvania State University Applied Research Lab., 2000
59. Sherman S. M.: *Monopulse Principles and Techniques*, Artech, 1984
60. Skolnik, M.: *Radar Handbook*, Third Edition. McGraw-Hill, 2008
61. Smith S. W.: *Digital Signal Processing: a practical guide for engineers and scientists*. Newnes, 2002
62. Valakama M., Renfors M.: *Second-order sampling of wideband signals*. Proc. of IEEE International Symposium on Circuits and Systems, ISCAS 2001, Vol. 2, pp. 801 - 804
63. Waite A. D.: *Sonar for practicing engineers*. Third Edition. Wiley (2002).

CONTACT WITH THE AUTHOR

Jacek Marszał, Ph.D.
 Gdansk University of Technology
 Faculty of Electronics, Telecommunications and Informatics
 Department of Marine Electronics Systems
 Narutowicza 11/12
 80-233 Gdansk, Poland
 e-mail: jacek.marszal@eti.pg.gda.pl