

HEAVE PLATES WITH HOLES FOR FLOATING OFFSHORE WIND TURBINES

Ewelina Ciba*

Paweł Dymarski

Mirosław Grygorowicz

Gdańsk University of Technology, Poland

* Corresponding author: ewelina.ciba@pg.edu.pl (E. Ciba)

ABSTRACT

The paper presents an innovative solution which is heave plates with holes. The long-known heave plates are designed to damp the heave motion of platforms. They are most often used for Spar platforms. The growing interest in this type of platform as supporting structures for offshore wind turbines makes it necessary to look for new solutions. Based on the available literature and the authors' own research, it was concluded that the main element responsible for the damping of heave plates is not so much the surface of the plate, but its edge. Therefore, it was decided to investigate the effect of the holes in heave plates on their damping coefficient. Model tests and CFD calculations were performed for three different structures: a smooth cylinder, a cylinder with heave plates with a diameter of 1.4 times the diameter of the cylinder, and a cylinder with the same plate, in which 24 holes were cut (Fig. 1). Free Decay Tests (FDT) were used to determine the damping coefficient and the natural period of heave, and then the values obtained were compared. The full and punched heave-plate designs were also tested with regular waves of different periods to obtain amplitude characteristics. The results obtained are not unequivocal, as a complex motion appears here; however, it is possible to clearly define the area in which the damping of a plate with holes is greater than that of a full plate.

Keywords: spar platforms, heave plates, damping coefficient, Floating Offshore Wind Turbines (FOWTs)

INTRODUCTION

Interest in offshore wind energy has been growing for years. Initially, mainly coastal structures appeared, but for a long time there has been a move to floating structures – Floating Offshore Wind Turbines (FOWTs). There are concepts of wind turbines based on various types of supporting structures. Most often, however, due to the large depths of the planned installation areas, the concepts of offshore wind turbines are based on spar-type platforms, as presented by Dymarski [1].

Designing structures for offshore wind energy is of course based on the knowledge and experience gained in the offshore oil industry. The problem of damping the heave motion of the Spar-type platform has already arisen in the case of oil rigs. In Haslum's work [2] we can find a number of alternative shapes of the Spar platform hull aimed at increasing the damping coefficient. One of them is the damping plate: a flat, round plate with a larger diameter added to the platform.

Extensive analyses of the damping plate effects were conducted by Subbullakshmi and Sundaravivelu [3]. The authors examined various plate configurations, depending on their diameter and position, and double plates. They noticed, among other things, that the damping effect of the plate increases when its diameter is increased to 1.4 times the diameter of the platform, and then it begins to decrease. This is confirmed by the conclusions drawn by Tao and Cai [4]. They analysed vortex structures around a heave plate cylinder of different diameters. The research shows that the vortices flowing from the edge of the plate should not be located too far from the cylinder surface, because then the damping is lower.

The research presented by Ciba [5] shows that a small plate with a diameter of ~ 1.1 greater than the diameter of the cylinder causes a significant increase in the damping coefficient. Hence the conclusion that the main element responsible for damping is not so much the surface of the plate, but rather its edge. This fact is also confirmed by the research presented by Mello et al.

[6], who analysed a heave plate with a skirt. Their research shows that an increase in skirt height does not always lead to an increase in damping.

So, if the main element responsible for the increase in damping obtained thanks to the use of the heave plate is its edge and the vortex structures flowing from it, it was decided to extend it by cutting holes in the plate. To test the effectiveness of this solution, the behaviour of three structures was tested: a smooth cylinder without heave plates, a cylinder with full heave plates, and a cylinder with heave plates with holes. Model tests and RANSE-CFD calculations of the Free Decay Test for all three structures were performed, which allowed us to determine the damping coefficients and periods of free oscillation, as well as testing the behaviour in regular wave conditions of cylinders equipped with heave plates.

Similar research for the circular porous plate itself was carried out by Tao and Dray [7]. They determined the hydrodynamic characteristics of an oscillating porous disc. The tests were carried out for forced oscillations. They noticed that the added mass coefficient is lower for the porous plate and that, with the low Keulegan-Carpenter number (KC) related to the amplitude of the displacements, there is an increase in damping for the porous plates.

Perforated square plates were examined by Song and Faltinsen [8]. Tests were also carried out for an insulated plate by means of forced oscillations. They also noticed a reduction in added mass through perforation and pointed out that, at low KC numbers, damping is mainly due to fluid flow through the holes.

Many other researchers have studied the hydrodynamic coefficients of oscillating structures. Holmes et al. [9] counted the added mass and drag coefficient using the least-mean squares method to fit Morison's equation to the force resultant histories predicted by the CFD solutions. The studies confirmed that the results of the direct solution of the Navier-Stokes equation can be an efficient and effective supplement to Morison-type simulation in platform design.

The hydrodynamic characteristics of the plate moved away from the bottom of the structure were investigated by Zhu et al. [10]. The results of their work indicate that the distance of the plate from the bottom of the structure does not have such a large effect on the increase of added mass as the increase in the radius of the plate.

The influence of the bottom shape (flat, rounded and semi-spherical) on the hydrodynamic coefficients was investigated by Gu et al. [11]. They noticed that the greatest increase in damping occurs at a flat bottom.

Devolder et al. drew attention to the problem of convergence in the calculations of a body moving in a two-phase medium [12]. They identified the instability mechanism and provided an algorithm to accelerate convergence. Dunbar et al. also pointed to the problem of convergence [13]. They developed and tested a tightly coupled CFD / 6-DOF solver to accelerate coupled solution convergence to eliminate the artificial added mass instability.

Maron et al. [14] examined the scale effect in the heave plates calculations. They indicated that the uncertainties due to the scale effects are in reality less important than that introduced

by the selection of a typical value for KC in order to estimate the viscous damping added in the state-of-the-art simulation codes in both the frequency and time domains used in offshore engineering.

PURPOSE AND SCOPE OF THE RESEARCH

The research aimed to answer the question of whether hole-cut heave plates have a higher damping factor than traditional full heave plates, and for which solution the amplitude characteristics of the vertical motion of the platform on the wave are better. An additional aim of the research was to compare the results obtained by the RANSE-CFD method with the results of model tests to confirm the correctness of using the calculations as a design tool.

For this purpose, model tests and calculations were performed for three structures: a smooth cylinder, a cylinder equipped with traditional heave plates with a diameter of 1.4 times the diameter of the cylinder, and a cylinder equipped with heave plates with holes (Fig. 1).

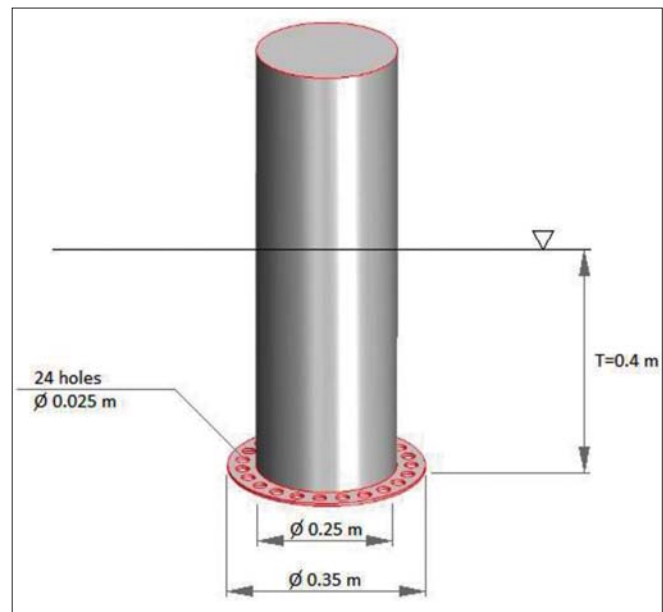

Fig. 1. Cylinder equipped with heave plates with holes

The Free Decay Test was carried out for each of the structures, and the damping coefficients and natural periods for each structure were calculated on their basis. Then, for structures equipped with heave plates, tests were performed on regular waves with an amplitude of $a = 0.01$ m and periods $T = 1.4$ s, 1.6 s, 1.8 s, 2.0 s.

MATHEMATICAL DESCRIPTION OF ISSUE

When submerged, under the influence of the initial force, the cylinder will then make an oscillating motion relative to the equilibrium position, with the amplitude of the movement decreasing with time. A mathematical description of the issue can be found in the literature [15].

We assume that the moving body is a rigid body and we replace the surface and volume forces by the movement of the point associated with the origin of the coordinate system. We also assume that the coefficients of the equation are constant over time, which causes the equation to become linear. This assumption is only true for a small amplitude of motion. In this case, the deflection is not more than 6 cm, so it can be used. The cylinder motion equation is given as:

$$(m + a) \cdot \ddot{z} + b \cdot \dot{z} + c \cdot z = 0 \quad (1)$$

where:

- z – vertical displacement [m]
- m – solid mass of cylinder [kg]
- a – hydrodynamic mass coefficient [kg]
- b – hydrodynamic damping coefficient [kg/s]
- c – restoring spring coefficient [kg/s²]

Equation (1) can be written as:

$$\ddot{z} + 2\nu \cdot \dot{z} + \omega_0^2 \cdot z = 0 \quad (2)$$

where the damping coefficient and the undamped natural frequency are defined as:

$$2\nu = \frac{b}{m + a} \quad \omega_0^2 = \frac{c}{m + a} \quad (3)$$

A non-dimensional damping coefficient κ is defined as:

$$\kappa = \frac{\nu}{\omega_0} = \frac{b}{2\sqrt{(m + a) \cdot c}} \quad (4)$$

Knowing the results of the free decay tests, we can calculate:

$$\kappa = \frac{1}{2\pi} \cdot \ln \left\{ \frac{z_{a_i} - z_{a_{i+1}}}{z_{a_{i+2}} - z_{a_{i+3}}} \right\} \quad (5)$$

Depending on the averaged displacement amplitude:

$$\overline{z_a} = \left\{ \frac{z_{a_i} - z_{a_{i+1}}}{z_{a_{i+2}} - z_{a_{i+3}}} \right\} \quad (6)$$

We calculate the hydrodynamic added mass coefficient as:

$$a = \frac{c}{\omega_0^2} - m \quad (7)$$

In the case of initial displacement z_a , Eq. (2) takes the form:

$$z = z_a e^{-\nu t} \left(\cos \omega_z t + \frac{\nu}{\omega_z} \sin \omega_z t \right) \quad (8)$$

Due to the fact that for the frequency of free oscillations $\omega_z^2 = \omega_0^2 - \nu^2$ and when the damping is small $\nu < 0.20$, $\nu^2 \ll \omega_0^2$, we can skip ν^2 and we can write that $\omega_z \approx \omega_0$.

RANSE-CFD CALCULATIONS

CFD calculations were made using STAR-CCM+. Non-stationary calculations were performed in the three-dimensional

domain, using the volume of fluid and K-epsilon turbulence models. Cylinder displacements were modelled in 3D using the dynamic fluid body interaction module with an overset mesh. The computational domain measuring 4 m x 2 m x 2.25 m was prepared as in Fig. 2.

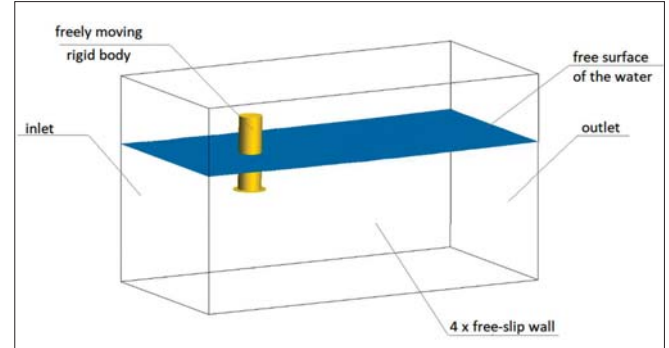

Fig. 2. Computational domain

At the inlet and outlet of the computational domain, the inlet velocity condition was set, setting the velocity and volume of the fraction for the appropriate wave. The remaining domain boundary walls were modelled as free-slip walls. The cylinder was treated as a rigid body with 3 degrees of freedom: vertical and horizontal displacements as well as rotation in relation to the y axis, which corresponds to the traditional body movements defined as surge (dx), heave (dz) and pitch (ry). Mass properties of the solid are presented in Table 1.

Tab. 1. Mass properties

Mass	19.63 kg
Centre of the mass	[0.0, 0.0, -0.21] m
Moment of inertia	[1.08, 1.08, 0.16] kg m ²

An overset mesh was used (Fig. 3), consisting of a moving (green) and a fixed (black) part, allowing the simulation of the object's movement. The mesh was compacted near the free water surface, around the heave plate and in the area expected to move the cylinder. On the surface of the cylinder, an element size of 0.002 m from 5 prism layers with a total thickness of 0.002 m was applied. A mesh was obtained consisting of 1,281,102 cells in the movable portion and 1,282,998 in the fixed portion.

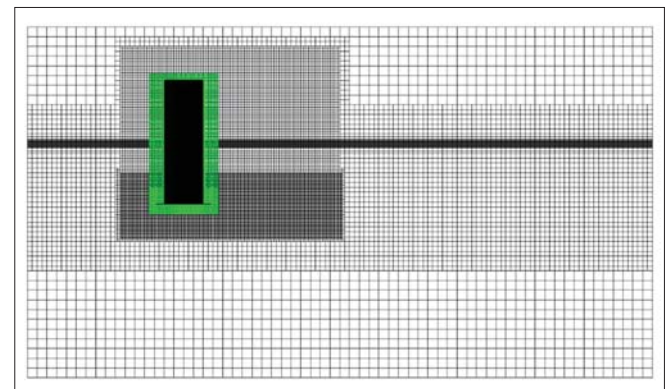

Fig. 3. Calculation grid in the symmetry plane divided into a movable (green) and a fixed (black) part

Calculations were performed with the time step $t_k = 0.01$ s. Displacements and rotations about the centre of gravity were measured.

In the Free Decay Test case, the initial draft was obtained by specifying the initial velocity of the solid $v_0 = -0.6$ m/s. The free oscillation for a cylinder with a full heave plate and a heave plate with holes is shown in Fig. 4.

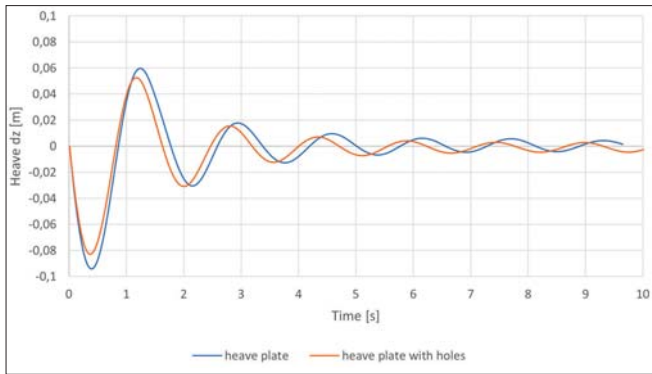

Fig. 4. Free Decay Tests

The free decay period decreases for successive oscillations. Average values of the natural periods of the structure were read (heave plate $T_{hp} = 1.63$ s and heave plates with holes $T_{hph} = 1.57$ s) and subsequent deflection amplitudes, which allowed us to calculate the damping coefficients depending on the averaged deflection amplitude (Fig. 5).

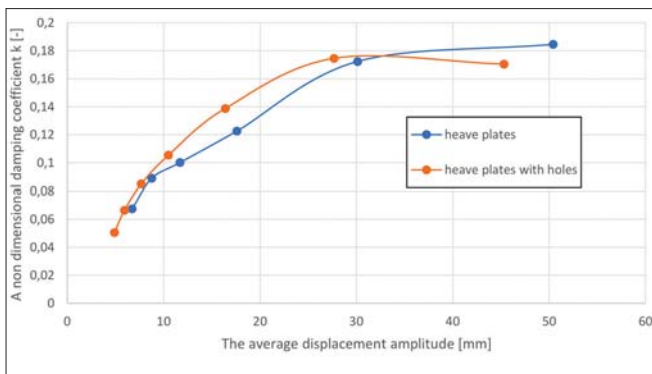

Fig. 5. A non-dimensional damping coefficient of heave motion

It can be seen from the diagram that, for the most part, the damping coefficient of the plate with holes is greater than that of the full heave plate.

Based on the period of free oscillation, the added mass was determined. The added mass for the cylinder with a solid plate is 12.88 kg and 10.37 kg for a plate with holes.

Time histories for each case were obtained from the simulation of the structure under regular wave conditions. An example of the course for a cylinder with heave plates with holes on a wave with period $T = 2$ s is shown in Figs 6 (heave) and 7 (pitch).

Looking at the vertical displacement figure, it can be seen that zero is not an equilibrium position. This is due to the fact that the displacement of the object is slightly smaller than the set mass. Due to the analysis of the damping coefficient depending on the averaged amplitude (Eqs. 5 and 6), it has no influence on its values.

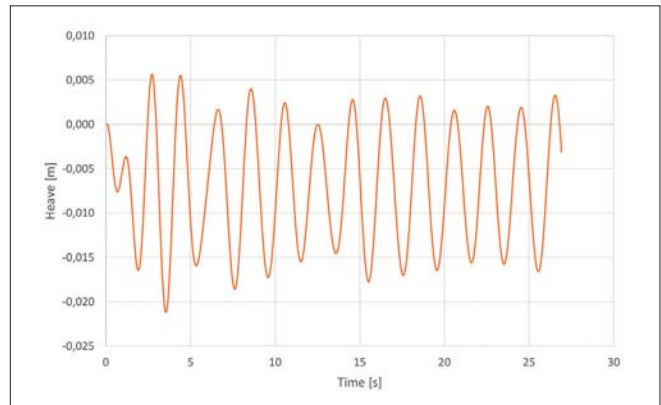

Fig. 6. Heave of cylinder with heave plates with holes on the regular wave $T=2$ s

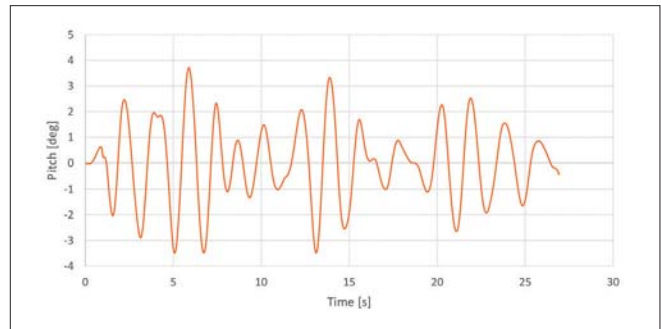

Fig. 7. Pitch of cylinder with heaveplates with holes on the regular wave $T=2$ s

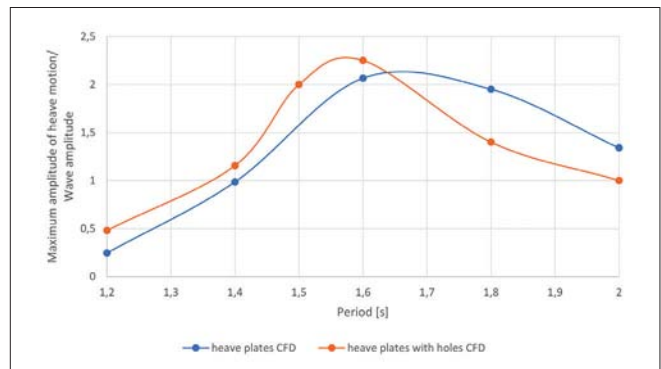

Fig. 8. Maximum amplitudes of heave motion

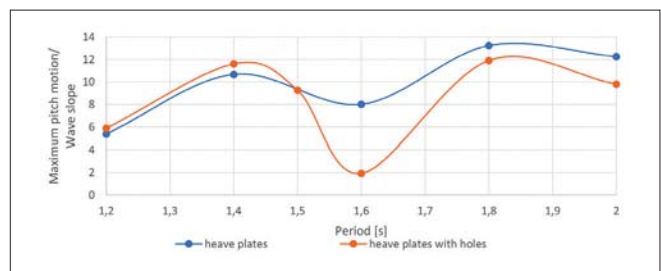

Fig. 9. Maximum amplitudes of pitch motion

Based on the calculated values, the maximum displacements of the structure were determined and are presented in Fig. 8 (heaving motion) and Fig. 9 (pitch motion).

According to the theory of the resonance phenomenon, the maximum displacement values for structures with a full plate as well as a plate with holes appear for waves with a period equal to the natural periods of the cylinders. In the case of waves with

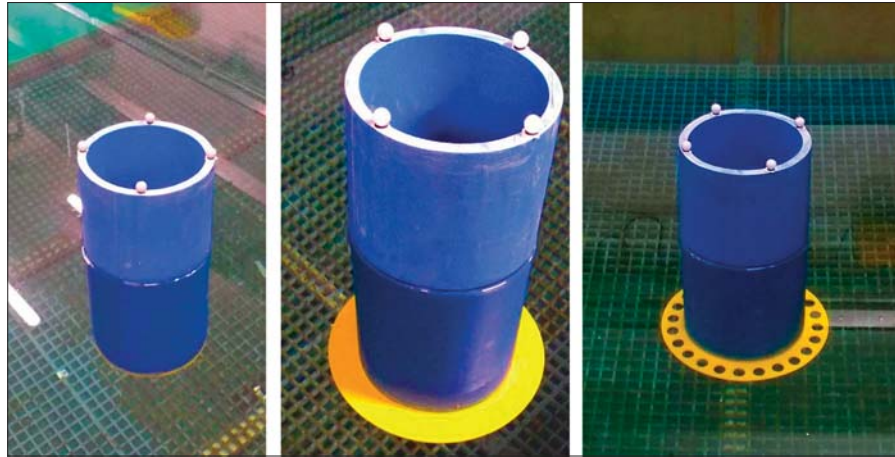

Fig. 10. The tested model in three different configurations

a period longer than 1.6 s, the displacement of the cylinder with the plate with holes is smaller, while the waves with the shorter period induce greater displacement of the cylinder with the plate with holes than the cylinder with a full plate. In the case of pitch, the situation is similar; for longer waves the movements of the cylinder with the plate with holes are smaller.

EXPERIMENT IN TOWING TANK

The model tests were carried out on a 40x4x3 m model pool at the Gdańsk University of Technology, equipped with a plate and an 8-segment regular and irregular wave generator (with a given spectrum of waves) with a maximum height of 0.25 m, designed and made by Edinburgh Design.

Structural displacements were measured by a system based on high-speed cameras to determine the position of the 6D object, named Qualisys. Measurements were made with an accuracy of 0.4 mm. Displacements and rotations about the centre of gravity were measured.

A model of a cylinder with interchangeable heave plates was prepared, resulting in three different structures as shown in Fig. 10. The balls on the top of the cylinder are optical markers used in the measuring device.

The desired cylinder draft was achieved by ballasting it inside with appropriate weights. Attempts were made to distribute the ballast evenly so that the initial structure floated without heeling, but in each case there was some initial deviation.

The initial draft was obtained by pressing the structure manually under the water. This way of conducting the research resulted in some additional movements that disturbed the results of the research.

The Free Decay Test was performed in series: two repetitions for a smooth cylinder and three for cylinders with plates. During each of the tests, the displacements of the structure were measured in all 6 degrees of freedom. The figures of the free heave and pitch oscillations of the structure were analysed. An exemplary plot of vertical displacements (Fig. 11) and pitch (Fig. 12) is provided for the heave plates with holes cylinder.

On the basis of the obtained results, the natural periods were determined as: 1.41 s for a smooth cylinder, 1.63 s for

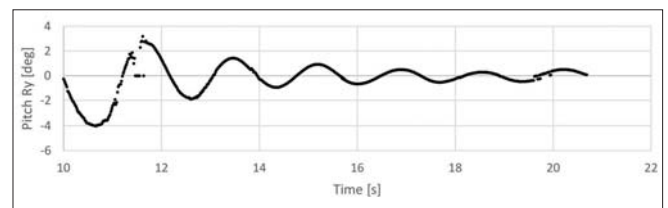

Fig. 11. Time history of vertical displacement

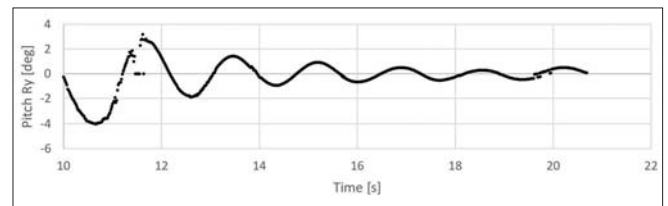

Fig. 12. Time history of pitch displacement

a full plate and 1.56 s for a plate with holes. The added masses calculated on this basis were 4.4 kg for a smooth cylinder, 12.7 kg for a full plate cylinder and 9.99 kg for a plate with holes. The damping coefficients were also calculated and are presented in Fig. 13.

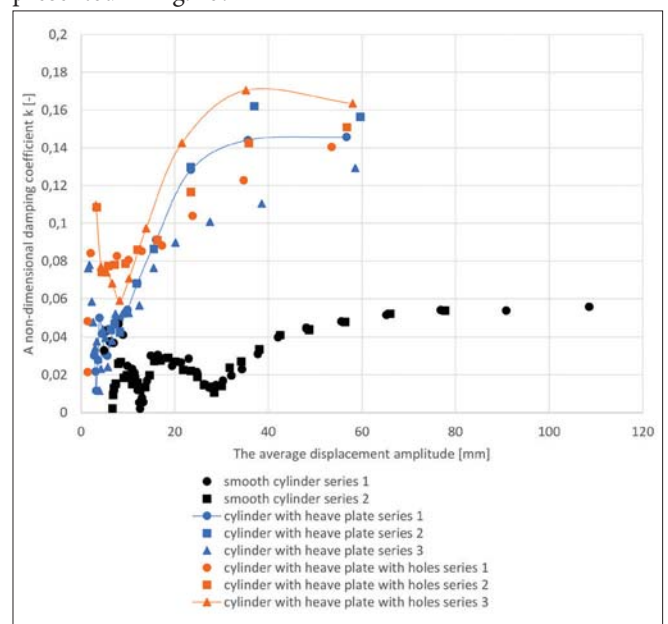

Fig. 13. A non-dimensional damping coefficient of heave motion

At extreme amplitudes of motion, the results are non-linear. This is most likely due to inaccuracies in the conduct of the experiment, and they are not taken into account.

The results of both runs on the smooth cylinder were very similar, while quite large differences were observed for the heave plate cylinders. Searching for the cause of the discrepancy, the displacements on the remaining degrees of freedom, which should be minimal, were checked. However, it was found that during some tests there were significant movements in the other directions, for example the pitch in series 2 for a cylinder with a plate with holes shown in Fig. 12. The results of series 1 for the cylinder with heave plates and series 3 for the cylinder with heave plates with holes were therefore considered most useful for analysis, as the pitches were the smallest. The results for these plots are linked with a line (blue and orange respectively) to facilitate analysis.

The results show that the use of heave plates significantly increases the value of the damping coefficient in relation to a smooth cylinder. It is also found that the damping factor of the plate with holes is greater than that of the plate without holes in the case of pure vertical movement. In the case of complex motion, the situation is not clear-cut.

Wave motion studies were performed with heave plate cylinders only. Displacement plots for a cylinder having heave plates with holes on a 2s period wave are shown below.

As can be seen from the presented figures, there are quite large movements in all six degrees of freedom. For the purposes of this article, the heave and pitch depending on the period of the forcing wave were analysed as the main ones. The maximum displacements are shown in respectively Figs 19 and 20.

On the basis of the obtained values, it can be concluded that, in the case of waves with a period longer than 1.6 s, the solution of heave plates with holes is better, i.e., that the movements of the structure are smaller.

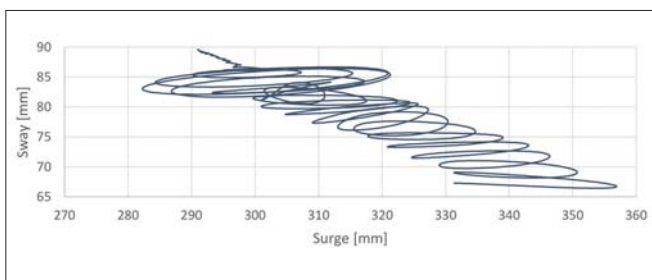

Fig. 14. Trajectory in the horizontal plane of cylinder with heave plates with holes on the wave $T=2s$

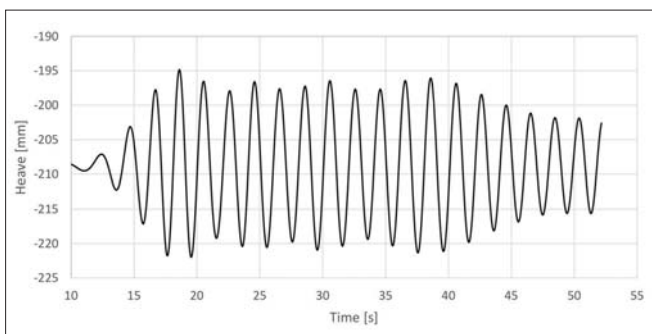

Fig. 15. Heave of cylinder with heave plates with holes on the wave $T=2s$

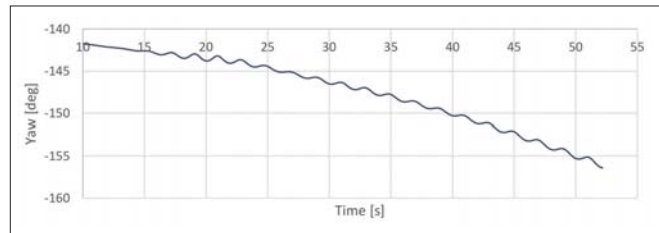

Fig. 16. Yaw of cylinder with heave plates with holes on the wave $T=2s$

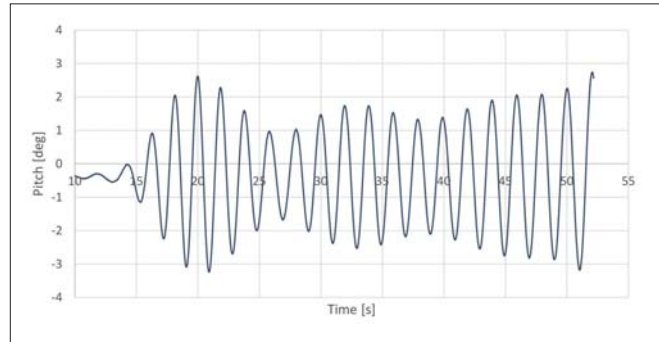

Fig. 17. Pitch of cylinder with heave plates with holes on the wave $T=2s$

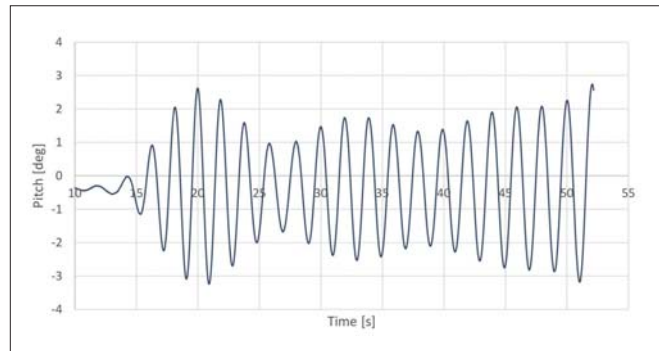

Fig. 18. Roll of cylinder with heave plates with holes on the wave $T=2s$

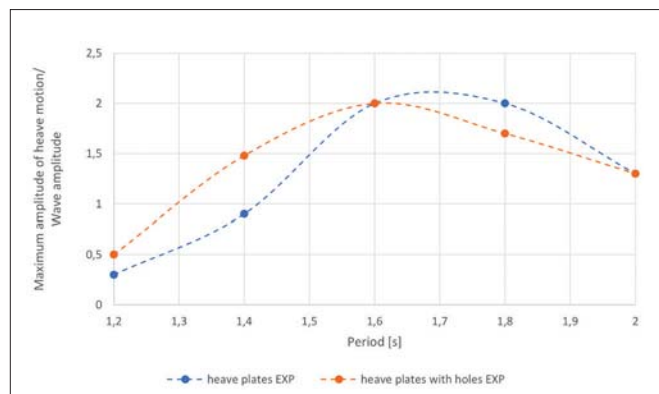

Fig. 19. Maximum amplitude of heave motion

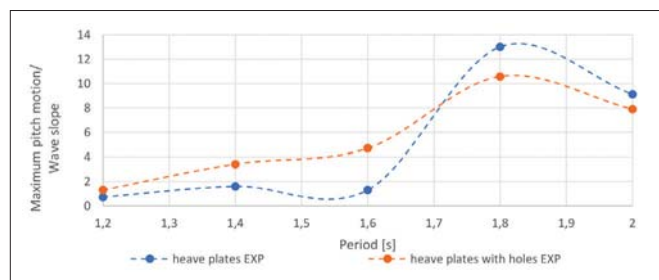

Fig. 20. Maximum amplitude of pitch motion

COMPARISON OF RESULTS OF THE CALCULATIONS AND THE EXPERIMENT

In order to assess the correctness and usefulness of the results obtained on the basis of the calculations, they were compared with the results obtained from the model tests. The added mass, calculated on the basis of the results, was very similar, with 1% difference for a full plate and less than 5% difference for a plate with holes. Both the calculations (Fig. 7) and the results of the experiment (Fig. 17) showed second-order harmonics in pitch. The figures show a comparison of the obtained values of the damping coefficient (Fig. 21) and the maximum heave and pitch of the structure on the wave (Fig. 22 and Fig. 23). The values obtained experimentally are marked with dashed lines. Both the damping coefficients and the amplitude of the wave motion measured on the experimental route are lower than those determined from the CFD calculations. This may be due to additional movements in the remaining degrees of freedom.

CONCLUSIONS

It is quite difficult to isolate vertical movement during the Free Decay Test in laboratory conditions, therefore, from three repetitions, the sample with the smallest additional movements was used for the analysis. The thus obtained hydrodynamic coefficients may be erroneous, so it is planned to repeat the research using forced oscillations and to compare the results obtained.

The main purpose of the presented tests was to evaluate the damping of heave plates with holes. Based on the results, it can be said that the damping coefficient in the vertical movement of the plate with holes is greater than that of the full plate. The damping factor increases with the increase of the deflection amplitude.

Cutting holes in the heaving plate reduces the added mass in relation to the full plate. Moreover, the added mass decreases with the disappearance of the motion amplitude. The obtained values of the added mass (~ 12.8 kg for a solid plate and ~10 kg for a plate with holes) are similar, although lower, compared to the theoretical values for a plate with a diameter of 0.35 m, equal to 14.26 kg.

Under regular wave conditions, heave plates with holes give better results than a full plate for waves longer than the natural period. The use of heave plates lengthens the natural period compared to the natural period for a smooth cylinder, but cutting holes in them reduces this gain. The results of the experimental studies differ from the calculations mainly because they show movements on the other degrees of freedom, which the calculations take into account. However, these differences do not disqualify calculations as an effective design tool. The obtained values are similar and allow us to draw the same conclusions.

In the case of pitch, the CFD calculations show quite good compatibility with the experiment only for waves with a period

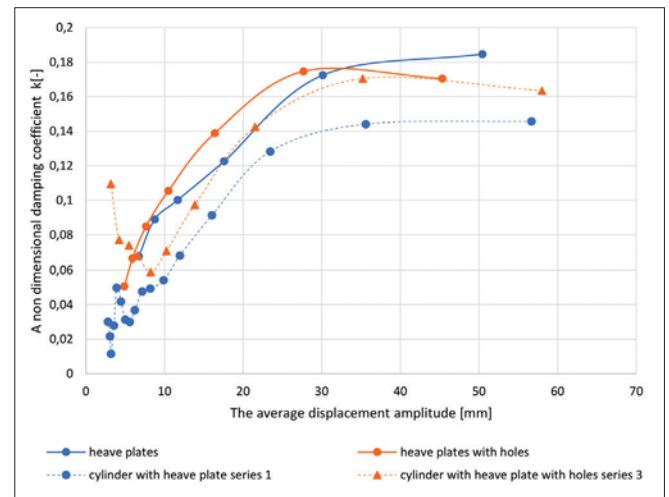

Fig. 21. Comparison of non-dimensional damping coefficient of heave motion

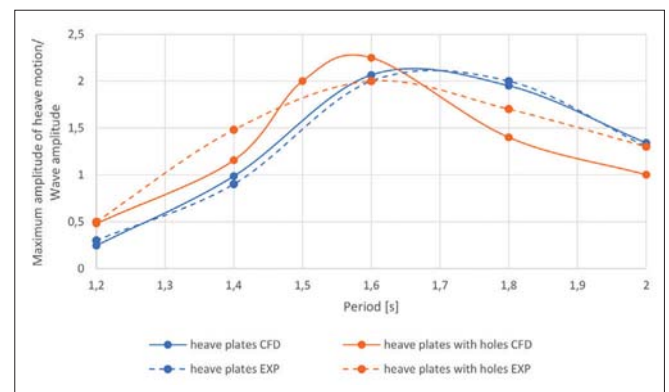

Fig. 22. Comparison of heave motion

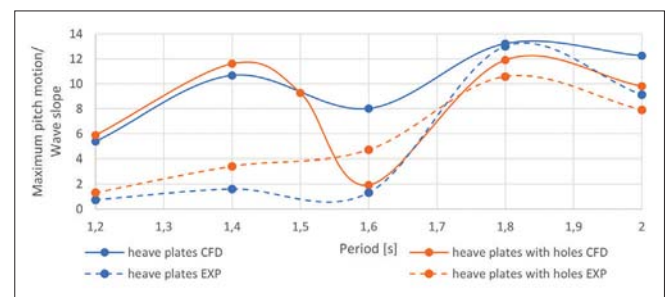

Fig. 23. Comparison of pitch motion

close to the free pitch period. For waves with smaller periods, a local maximum appears on the maximum amplitude of pitch motion figure, which was not confirmed by the research.

Heave plates with holes are very promising. The next step in the work should be to analyse more broadly the effect of holes of various diameters and configurations on the performance of heave plates. The conclusions drawn from the presented tests may also be used in the design of other floating structures.

ACKNOWLEDGEMENT

The calculations were performed using a Simcenter STAR-CCM+ licence.

REFERENCES

1. P. Dymarski, C. Dymarski, E. Ciba, (2019): "Stability Analysis of the Floating Offshore Wind Turbine Support Structure of Cell Spar Type during its Installation," *Polish Maritime Research*, vol. 26, 4(104), 109-116.
2. H. A. Haslum, (2000): *Simplified Methods Applied to Nonlinear Motion of Spar Platforms*. Norwegian University of Science and Technology, Trondheim.
3. A. Subbulakshmi, R. Sundaravadivelu, (2016): "Heave damping of spar platform for offshore wind turbine with heave plate," *Ocean Engineering*, vol. 121, pp. 24-36.
4. L. Tao, S. Cai, (2004): "Heave Motion Suppression of a Spar with a Heave Plate," *Ocean Engineering*.
5. E. Ciba, (2021): "Heave Motion of a Vertical Cylinder with Heave Plates," *Polish Maritime Research*, vol. 28, issue 1(109), pp. 42-47.
6. P.C. Mello, R.O.P Silva, E. Malta, L.H.S. Carno, (2019) Influence of heave plates on the dynamics of floating offshore wind turbine in waves, Conference Paper
7. L. Tao, D. Dray, (2008): "Hydrodynamic performance of solid and porous heave plates," *Ocean Engineering* 35(10), doi:10.1016/j.oceaneng.2008.03.003[
8. A. Song, O.M. Faltinsen, (2013): "An experimental and numerical study of heave added mass and damping of horizontally submerged and perforated rectangular plates," *Journal of Fluids and Structures*, vol. 39, pp. 87-101.
9. S. Holmes, P. Beynet, A. Sablock, I. Prislina, (2001): "Heave Plate Design with Computational Fluid Dynamics," *Journal of Offshore Mechanics and Arctic Engineering*123(1).
10. L. Zhu, H.Ch. Lim, (2017): "Hydrodynamic characteristics of a separated heave plate mounted at a vertical circular cylinder," *Ocean Engineering*, vol. 131, pp. 213-223.
11. H. Gu, P. Stansby, T. Stallard, E. C. Moreno, (2018): "Drag, added mass and radiation damping of oscillating vertical cylindrical bodies in heave and surge in still water," *Journal of Fluid and Structures*, vol. 82, pp. 343-356.
12. B. Devolder, P. Troch, K. Rauwoens, (2019): "Accelerated numerical simulations of heaving floating body by coupling a motion solver with a two-phase fluid solver," *Computers & Mathematics with Applications*77(6):1605-1625.
13. A.J. Dunbar, B.A. Craven, E. G. Paterson, (2015): "Development and validation of tightly coupled CFD/6-DOF solver for simulating floating offshore wind turbine platforms," *Ocean Engineering*, vol. 110, pp. 98-105.
14. A. Maron, E. M. Fernandez, A. Valea, C. Lopez-Pavon, (2019): "Scale Effects on Heave Plates for Semi-Submersible Floating Offshore Wind Turbines: Case Study With a Solid Plain Plate," *Journal of Offshore Mechanics and Arctic Engineering*142(3):1-14.
15. J. M. J. Journee, W. W. Massie, (2001): *Offshore Hydromechanics*. Delft University of Technology.

CONTACT WITH THE AUTHORS

Ewelina Ciba

e-mail: ewelina.ciba@pg.edu.pl

Paweł Dymarski

e-mail: pawel.dymarski@pg.edu.pl

Mirosław Grygorowicz

e-mail: miroslaw.grygorowicz@pg.edu.pl

Gdańsk University of Technology

Narutowicza 11/12

80-233 Gdańsk

POLAND