

## OPTIMIZATION OF WING PARAMETERS TO ACHIEVE MINIMUM WEIGHT AT DEFINED AERODYNAMIC LOADS

STANISŁAW KACHEL

*Military University of Technology (MUT), Warsaw, Poland*  
*e-mail: stanislaw.kachel@wat.edu.pl*

The paper presents the method suitable for optimization of parameters and applied to design aircraft subassemblies on the example of a swept wing. It outlines the assumptions that are necessary to develop a mathematical model and describes constraints that served as the basis to develop an algorithm and describe the corresponding procedures in the GRIP (Graphics Interactive Programming) language that is a part of the CAD/CAM/CAE Unigraphics system. The further part of the study comprises discussion how the wing parameters and the mass functional are affected by the rigidity constraints and strength constraints. The algorithm for designing aircraft components was finally developed with inputs to the multi-criteria design process “Web Modelling” of an aircraft body. The study also includes initial assumptions to algorithms originally developed by the author and dedicated to the modelling of components incorporated into aircraft structures.

*Key words:* aircraft structure optimization, parametrical design systems

### 1. Introduction

The design process of an aircraft body is associated with selection of great many parameters that can be mutually interconnected by criteria that must be fulfilled by a generally understood objective function. From among a number of design methods, the most frequently applied and efficient one is the hierarchical design approach with the use of parametrical modelling. Designing of an aircraft body represents a certain compromise between meeting various criteria related to weight, load, strength, generally understood operation feasibility and manufacturability. Prior to the phases of conceptual draft and preliminary engineering, the designing process must be preceded by the stage of assumptions and setting up about the most important criteria that must be mandatorily met during the subsequent design phase of the future aircraft. The study outlines assumption to the description and development of a mathematical model for an aircraft wing that served as the basis to develop an algorithm intended to seek for major parameters of the wing that would meet the presumed strength criteria for aerodynamic loads. An alteration of the optimized parameters was considered with regard to the following criteria: separately strength and aerodynamic loads or combined strength and aerodynamic loads.

### 2. The mathematical model of an aircraft wing with consideration to the sweep-back angle

Beside the determination of an aircraft mission, the design process of a wing needs consideration of static problems associated with wing deformations, where account must be taken to the  $\chi$  parameter for a swept wing with large elongation within airflow around the subsonic velocity. Major parameters and a simplified diagram of the wing are shown in Fig. 1.

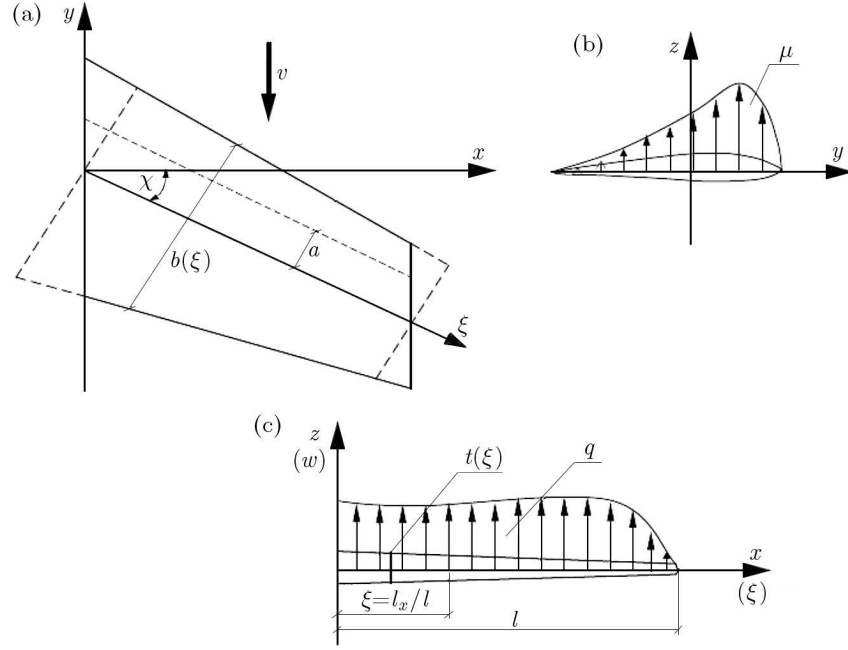

Fig. 1. Diagram of a swept wing with specification of major parameters: (a) within the  $x$ - $y$  plane; (b) parameters within the  $x$ - $z$  plane

An aircraft wing is a thin-shell structure, where the rigidity properties are defined by cross-section parameters within the plane that is perpendicular to the plane of chords. Such an assumption enables one to describe behaviour of the object, i.e. determine its displacements, with the use of the beam model of the wing structure. In general, displacements due to bending and torsions of the wing can be described with a system of ordinary differential equations

$$\frac{d^2}{d\xi^2} \left( EI \frac{d^2 w(\xi)}{d\xi^2} \right) = q \quad \frac{d}{d\xi} \left( GI_0 \frac{dw(\xi)}{d\xi} \right) = \xi \quad (2.1)$$

with the following boundary conditions

$$\begin{aligned} w(0) = \frac{dw(\xi)}{d\xi} = 0 & \quad \left( EI \frac{d^2 w(\xi)}{d\xi^2} \right)_{\xi=l} = \left( \frac{d}{d\xi} \left( EI \frac{d^2 w(\xi)}{d\xi^2} \right) \right)_{\xi=l} = 0 \\ \xi(0) = 0 & \quad \left( GI_0 \frac{d\xi(\xi)}{d\xi} \right)_{\xi=l} = 0 \end{aligned} \quad (2.2)$$

where  $w(\xi)$  and  $\Theta(\xi)$  stand for the functions that describe bending and torsion,  $EI(\xi)$ ,  $GI_0(\xi)$  – wing rigidity, respectively against bending and torsion,  $q$  and  $\mu$  – distribution of aerodynamic loads. The boundary conditions are defined for the cross section, where the wing is fixed to the fuselage ( $\xi = 0$ ) and at the free end of the wing ( $\xi = 1$ ).

The distribution of aerodynamic forces and moments can be found out from the following equations

$$\begin{aligned} q = \frac{dc_z}{d\alpha} (\alpha_0 + \Delta\alpha) \frac{\rho v^2}{2} b(\xi) \cos \chi & \quad \mu = a q \\ \Delta\alpha = \Theta \cos \chi - \frac{dw(\xi)}{d\xi} \sin \chi & \end{aligned} \quad (2.3)$$

where  $dc_z/d\alpha$ ,  $\alpha$ ,  $\rho v^2/2$ ,  $\chi$  are established parameters: the differential of the aerodynamic lift, initial angle of attack, dynamic pressure and sweep-back angle of the wing, whilst  $a(\xi)$ ,  $b(\xi)$

stand for the functions that represent respectively the distance between the line of aerodynamic focuses and the rigidity as well as the length of the local chord of the wing. The aforementioned parameters are marked in Fig. 1.

Let us assume that the bending and torsional rigidity are linearly interdependent

$$GI_0(\xi) = k(\xi)EI(\xi) \quad (2.4)$$

where  $k(\xi)$  is the predefined function that matches together the bending and torsion of the wing.

The weight functional for the structural and strength system of the wing is determined from the following relationship

$$GI_0(\xi) = \gamma(\xi)EI(\xi) \quad (2.5)$$

where  $\gamma(\xi)$  is the function that represents distribution of density.

The  $EI(\xi)$  function describes distribution of rigidity down the wing span and defines quality of the desired variable, it must always adopt positive values. The design process assumes that  $EI(\xi)$  is superposed by weak constraints of the inequality

$$EI_{max} \geq EI(\xi) \geq EI_{min} > 0 \quad (2.6)$$

where  $EI_{min}$  stands for the minimum permissible bending rigidity for the issue in question. Another constraint to distribution of the bending rigidity results from the strength condition

$$\max\left(t(\xi)\frac{d^2w(\xi)}{d\xi^2}\right) \leq \sigma_0 \quad (2.7)$$

For condition (2.7), the parameter  $t(\xi)$  represents the function that describes alterations of the wing parameters in order to sustain strength condition (2.7),  $\sigma_0$  is the ratio of the maximum permissible tensions  $\sigma$  and the elasticity (Young) modulus attributable to the material that was used for construction of the model ( $\sigma_0 = \sigma/E$ ). Meeting strength condition (2.7) needs to resolve equations (2.1) to (2.3) pursuant to the established boundary conditions with the assumed  $EI(\xi)$  and to find out the function that describes the bending process. The  $GI_0(\xi)$  that appears in the second equation of system (2.1) adopts the form just as in equation (2.4).

The optimization problem that is the subject matter of this study consists in determination of the rigidity distribution  $EI(\xi)$  that would minimize functional of the wing weight (2.5) with (2.6), (2.7) constrains.

To make further deliberations more convenient and to enable implementation of the idea, CAD/CAM/CAE Unigraphics (Danilecki, 2000; Kiciak, 2000) was provided with non-dimensional parameters that are indispensable to resolve the task for the specific rigidity criterion defined by equations (2.1) to (2.7), whilst the coordinate  $\xi$  was referred to the wing span and it adopts values within the interval  $\langle 0; 1 \rangle$

$$\begin{aligned} \bar{w} &= \frac{w}{l} & \bar{b} &= \frac{b}{l} & \bar{a} &= \frac{a}{l} & \bar{z} &= \frac{d\bar{w}(\xi)}{d\xi} \\ \bar{t} &= \frac{t}{l} & \bar{\gamma} &= \gamma l^3 & \bar{EI} &= EI \left( \frac{dc_z}{d\alpha} l^4 \frac{\rho v^2}{2} \right)^{-1} \\ \beta_1 &= -\bar{b} \sin \chi \cos \chi & \beta_2 &= \bar{b} \cos^2 \chi \\ \beta_3 &= \alpha_0 \bar{b} \cos \chi & \beta_4 &= -\bar{a} \beta_1 \\ \beta_5 &= -\bar{a} \bar{b} \cos^2 \chi & \beta_6 &= -\alpha_0 \bar{a} \bar{b} \cos \chi \end{aligned} \quad (2.8)$$

The equations, constrains (2.1) to (2,3) as well as the functional described by means of equation (2.5) with consideration to the non-dimensional parameters from equation (2.8) can be rewritten in the following form

$$\begin{aligned} \frac{d^2}{d\xi^2} \left( \overline{EI} \frac{d\bar{z}(\xi)}{d\xi} \right) &= \beta_1 \bar{z} + \beta_2 \Theta + \beta_3 & \frac{d}{d\xi} \left( \overline{GI} \frac{d\Theta(\xi)}{d\xi} \right) &= \beta_4 \bar{z} + \beta_5 \Theta + \beta_6 \\ \bar{z}(0) = 0 & \quad \left( \overline{EI} \frac{d\bar{z}(\xi)}{d\xi} \right)_{\xi=1} = \left[ \frac{d}{d\xi} \left( \overline{EI} \frac{d\bar{z}(\xi)}{d\xi} \right) \right]_{\xi=1} = 0 \end{aligned} \tag{2.9}$$

where boundary conditions (2.6) and weight functional (2.5) of the wing components adopt form (2.11)

$$\Theta(0) = 0 \quad \left( \overline{GI} \frac{d\Theta(\xi)}{d\xi} \right)_{\xi=1} = 0 \tag{2.10}$$

and

$$V = \int_0^1 \bar{\gamma}(\xi) \overline{EI}(\xi) d\xi \tag{2.11}$$

with respect to equations (2.4), (2.6), (2.7), substitution of variables is indifferent to the meaning of canonical equations.

Notation (2.7) considered by in studies Asselin (1987), Boehem (1984), Błaszczyk (1996), and also included into the optimization, was used in Section 3.

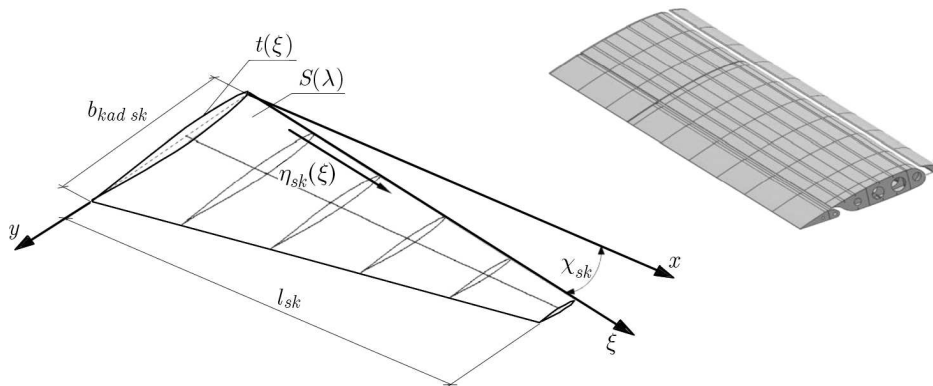

Fig. 2. The deployment diagram for the parameters assumed for the generalized model of an aircraft wing

### 3. Minimization of the wing weight with consideration to the constraint for aerodynamic load

As far as the aircraft wing is concerned, one of the considerably adverse phenomena that has to be considered during the design process is variation of the attack angle. It is the phenomenon that entails alteration of the aerodynamic lift and, in consequence, drop of the aircraft performance characteristics. It is why the critically important factor for the design process of the aircraft body is to achieve the optimum aerodynamic properties with simultaneous fulfillment of the imposed criterion of the minimum weight of the structure and, therefore, the weight of the wing. The analysis how the mentioned criterion influences the most favourable distribution of the wing weight down its span was carried out on the basis of the model, where the distribution of cross-section parameters in function of variations exercised by the  $E$  and  $I$  values. Such an approach

is sufficient to carry out the optimization process of slender structures. The aerodynamic loads represent a vector of external loads and are determined during the process of initial design according to the band theory, with consideration to elastic strain of the wing. The considerations abstained from going deeply into details associated with searching for sophisticated methods dedicated to determination of loads, as such methods are described in other studies (Bochenek and Kruzelecki, 2007; Brusov, 1996; Goraj and Sznajder, 1995; Hang, 1978; Majid, 1981; Olejnik, 1996; Olejnik *et al.*, 2006; Sibilski, 2004) and can be adapted to the calculation method as disclosed above. For such a formulation of the tasks, the structure status can be defined by means of equations (2.1)(2.3). For such a case the considerations are focused on variations of the rigidity  $EI(\xi)$  down the wing span. The relationship between the bending rigidity and the torsional rigidity as well as expressions for the minimized functional of the wing weight and the impact of the adopted constraint of the ‘not less than’ type onto the permissible distribution of rigidity can be written according to relationships (2.4) to (2.6).

The rigidity distribution  $EI(\xi)$  for a wing is superposed with the constraint in the form of the aerodynamic load

$$\int_0^l q \, d\xi \geq \frac{1}{2}(p_0 - \Delta p) \quad (3.1)$$

where  $p_0$  is a constant parameter (e.g. the aircraft weight) that is equal to such an aerodynamic lift that corresponds to the initial wing status (deformation-free)

$$\alpha_0 \frac{dc_z}{d\alpha} \frac{\rho v^2}{2} \cos \chi \int_0^l b \, d\xi = \frac{1}{2} p_0 \quad (3.2)$$

where  $\Delta p$  is the permissible drop of the aerodynamic lift due to elastic strain. The constant parameters  $p_0$  and  $\Delta p$  are defined and considered as the known values. The constraint that takes account for aerodynamic properties can be expressed with the use of formula (2.3) and the expression for the aerodynamic lift

$$\frac{dc_z}{d\alpha} \frac{\rho v^2}{2} \cos \chi \int_0^l \left( \Theta \cos \chi - \frac{dw(\xi)}{d\xi} \sin \chi \right) b \, d\xi = -\frac{\Delta p}{2} \quad (3.3)$$

For non-dimensional values, the variables adopt the following form

$$\bar{p}_0 = p_0 \left( \frac{dc_z}{d\alpha} l^2 \frac{\rho v^2}{2} \right)^{-1} \quad \Delta \bar{p} = \Delta p \left( \frac{dc_z}{d\alpha} l^2 \frac{\rho v^2}{2} \right) \quad \kappa = \frac{\Delta \bar{p}}{\bar{p}_0} \quad (3.4)$$

When considering relationships (2.8), the status equation can be expressed in forms of (2.9) to (2.11), whilst constraint (3.3) adopts the form

$$\int_0^1 (\beta_1 z + \beta_2 \Theta) \, d\xi \geq -\kappa \frac{\bar{p}_0}{2} \quad (3.5)$$

Upon introduction of the conditions that are necessary for optimum designing (2.6), (2.9) to (2.11), (3.5), the method of Lagrange factors is applied together with the method of iterative approximation of the functional with consideration to differential equations (Björck and Dahlquist, 1987; Cea, 1976; Lawrynowicz, 1977). For the considered case, the coupled variables  $s(\xi)$  and  $r(\xi)$  meet the boundary conditions

$$EI \frac{d^2 s(\xi)}{d\xi^2} + \beta_1 s + \beta_4 r - \lambda \beta_1 = 0 \quad GI \frac{dr(\xi)}{d\xi} - \beta_2 s - \beta_5 r + \lambda \beta_2 = 0 \quad (3.6)$$

and

$$\begin{aligned} s(0) = \frac{ds(0)}{d\xi} = 0 & \quad \left( EI \frac{d^2 z(\xi)}{d\xi^2} \right)_{\xi=1} = 0 \\ r(0) = 0 & \quad \left( GI_0 \frac{dr(\xi)}{d\xi} \right)_{\xi=1} = 0 \end{aligned} \quad (3.7)$$

The expression for the first variation of the functional adopts the form

$$\delta V = \int_0^l \delta EI \left( \gamma + \frac{d^2 s(\xi)}{d\xi^2} \frac{dz(\xi)}{d\xi} - \frac{dr(\xi)}{d\xi} \frac{d\Theta(\xi)}{d\xi} k \right) d\xi \quad (3.8)$$

where  $k$  is a constant parameter.

The necessary condition to achieve minimum of the functional  $V$  under constraint (2.6) is expressed by the inequality  $\delta V \geq 0$ . From that inequality, one can derive the necessary conditions for the optimized solution

$$\gamma + \frac{d^2 s(\xi)}{d\xi^2} \frac{dz(\xi)}{d\xi} - \frac{dr(\xi)}{d\xi} \frac{d\Theta(\xi)}{d\xi} k \begin{cases} = 0 & \text{for } EI \geq EI_{min} \\ \geq 0 & \text{for } EI = EI_{min} \end{cases} \quad (3.9)$$

Simultaneously, the following provision must be fulfilled

$$\lambda \left( \int_0^1 (\beta_1 z + \beta_2 \Theta) d\xi + \frac{\kappa \bar{p}_0}{2} \right) = 0 \quad \lambda \leq 0 \quad (3.10)$$

The foregoing provision makes it possible to find out that in the case when the inequality for the constraint of aerodynamic loads is fulfilled, the multiplication factor  $\lambda = 0$ .

#### 4. Implementation of the procedure dedicated to searching for parameters of an aircraft wing with the target of minimum weight and with consideration of constraints imposed by aerodynamic loads

The deliberations in Section 4 lead to the inference that the approaching process to the final solution was carried until the provisions expressed by equation (3.9) are met with the required accuracy. For numerical calculations, a relevant procedure was developed in GRIP language (Electronic Data Systems, 1999) (for example):

```
. . . (declarations of arrays)
    $$ Initial values
SCALAR$$ REFERENCE POINT ON THE CHORD
CROOT $$ CHORD WITHIN THE SYMMETRY PLANE
CTIP  $$ END CHORD OF THE WING
FI    $$ DIHEDRAL ANGLE
SPAN  $$ WING LENGTH MEASURED FROM THE SYMMETRY PLANE
CHI   $$ SWEEP-BACK ANGLE
ALFZ  $$ ANGLE OF WING SETTING
LZEB  $$ NUMBER OF WING RIBS
L2:
PARAM/'DANE SKRZYDLA', $
(...)
JUMP/L2:, TERM:,, RSP1
```





```

SRFDP=TRANSF/MATX1,SRFDL
NRVSWP=TRANSF/MATX1,NRVSWL
NRVSZP=TRANSF/MATX1,NRVSZL
$$ CREATION OF THE WING BODY
  SOLSL=SEW/NRVSWL,NRVSZL,SRFGL,SRFDL
  SOLSP=SEW/NRVSWP,NRVSZP,SRFGP,SRFDP
ANLSIS/SOLID,SOLSL,KGM,S_WYN
PRINT/USING,'MASA SKRZYDLA=#@@@@@.@@@@@@ M3',S_WYN(3)
. . .(subsequent procedures for analysis and formatting of ranking balances)

```

The procedure reflects the algorithm that is shown in the flowchart - Fig. 3 (Kachel, 2008, 2009).

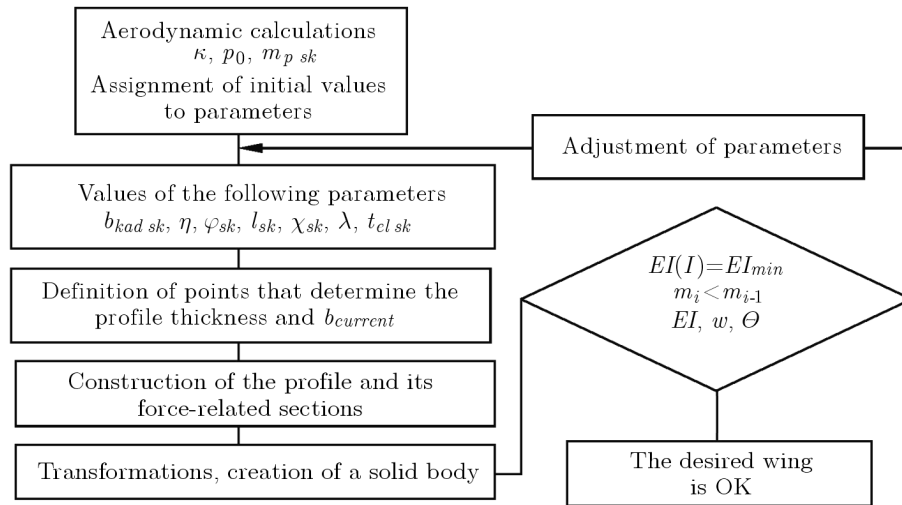

Fig. 3. A flowchart of the algorithm to determine optimum parameters of an aircraft wing with consideration to the constraint imposed by aerodynamic loads

The calculations were carried out for the following input data:  $k = 4$ ,  $\gamma = 1$ ,  $dc_z/d\alpha = 5.1$ ,  $EI_{min} = 0.01$ ,  $b = (2 - \xi)/12$ ,  $p_0 = 1/24$ . The problem was resolved for various values of the sweep-back angle  $\chi$  and loss of the aerodynamic lift  $\kappa$ .

The solid line in the graphs below (Figs. 4 to 7) is used to depict the determined relationships with account for the contribution of torsions, whilst the dashed line represents the waveforms with no consideration to torsions. One can see that the wing torsion can be neglected since the rigidity  $GI_0 \gg EI$ , which means that  $\Theta(\xi) \equiv 0$ .

Figure 4 shows the results achieved for the optimized distribution of the rigidity  $EI(\xi)$  for the assumed value of  $\kappa = 0.05$ .

The analysis reveals that variation of the sweep-back angle of the wing within the range from  $\chi = 0^\circ$  to  $\chi = 45^\circ$  leads to improvement of the rigidity distribution, whilst the subsequent increase of the sweep-back angle  $\chi$  is associated with a diminished effect of the torsional rigidity. Figures 4b and 4c present the effect of torsional angles as well as the bending effect onto the newly designed structure.

The relationship between the functional of the wind weight and the sweep-back angle  $\chi$  for  $\kappa = 0.05$  is shown in Fig. 5 with the dotted line with its maximum for  $\chi = 45^\circ$ , which means that the best possible solution is achieved for  $\chi = 45^\circ$ .

Figure 6 shows distribution of the bending rigidity  $EI(\xi)$ , displacements due to bending  $w(\xi)$  and torsional angles  $\Theta(\xi)$ . The angle  $\chi$  for all the curves equals to  $45^\circ$ . The comparison between individual graphs for  $EI(\xi)$  with various  $\kappa$  parameters indicates that the drop of the wing rigidity entails growth of the wing displacement. Figure 7 depicts variation of the weight



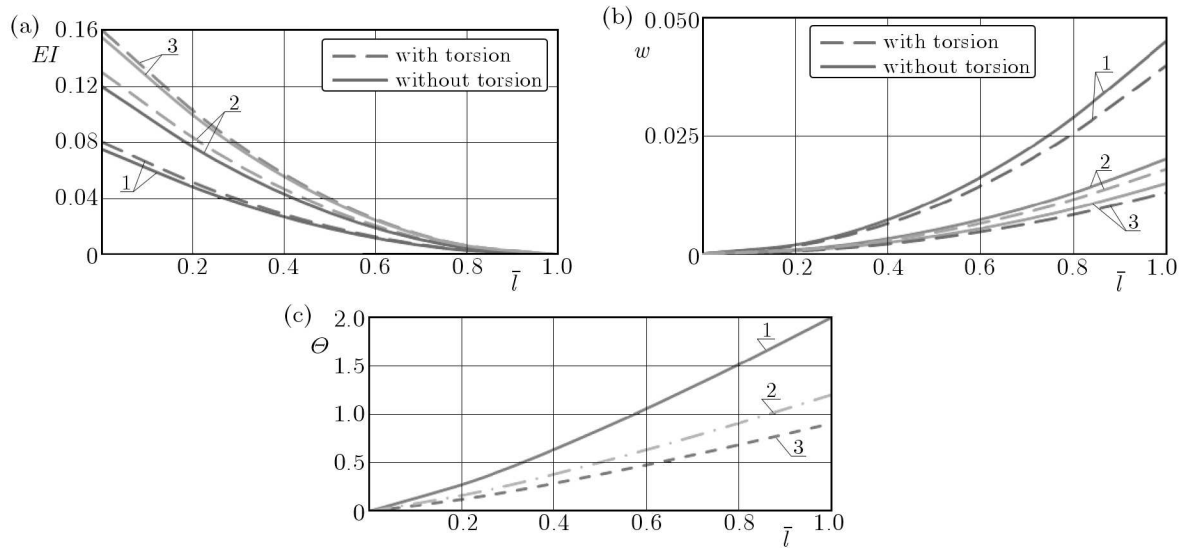

Fig. 4. Distribution of the rigidity-related parameters for various sweep-back angles  $\chi$ : (a) – bending rigidity; (b) – displacements due to bending; (c) – torsional angles. The curves are plotted for the following sweep-back angles of the wing: 1 –  $\chi = 15^\circ$ , 2 –  $\chi = 45^\circ$ , 3 –  $\chi = 60^\circ$

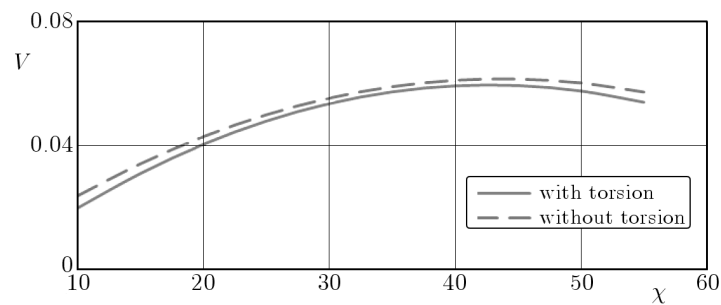

Fig. 5. The relationship between the weight functional  $V$  and the sweep-back angle  $\chi$  of the wing

functional  $V$  of the most advantageous wings as a function of the permissible loss  $\kappa$  of the aerodynamic lift. Curves 1, 2 correspond to the parameters  $\chi = 15^\circ$  and  $45^\circ$ .

Dashed lines in graphs (Figs. 4 to 6) are used to indicate the curves that are plotted without consideration to the torsion, which corresponds to the value of  $\kappa = \infty$ . The comparison of graphs against corresponding relationships that take account for torsion serve as the evidence that the visible difference can merely be seen for cases with low sweep-back angles  $\chi$ .

The foregoing phenomenon serves as the evidence that the torsional effect increases in pace with the decrease of the sweep-back angle  $\chi$  of the wing. When the satisfying weight of the wing is achieved as a result of the engineering process, it considerably affects the possibility to achieve the optimum distribution of rigidity for the wing with the rigidity  $EI = \alpha b$  ( $\alpha = \text{const}$ ). Such a distribution guarantees that the same loss of the aerodynamic lift corresponds to reciprocal sweep-back angles of the wings.

The analysis of possibility to achieve the optimum solution depending on the sweep-back angle  $\chi$  for the wing makes one notice that equations (2.9) depend on the attack angle  $\alpha_0$  by means of the coefficients  $\beta_3$  and  $\beta_6$ . The parameter  $\alpha_0$  is bound with the variable  $p_0$  by means of relationship (3.2).

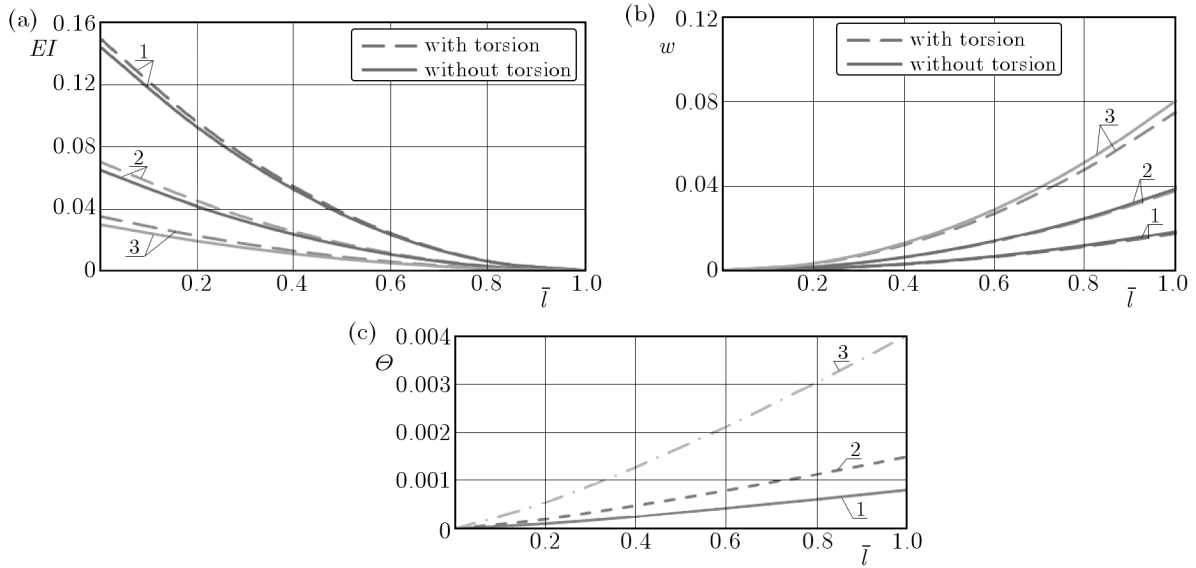

Fig. 6. Distribution of wing parameters with regard to the coefficient  $\kappa$  for loss of aerodynamic lift: (a) distribution of rigidity, (b) distribution of displacements due to bending; (c) distribution of torsional angles; 1 -  $\kappa = 0.05$ ; 2 -  $\kappa = 0.1$ ; 3 -  $\kappa = 0.2$

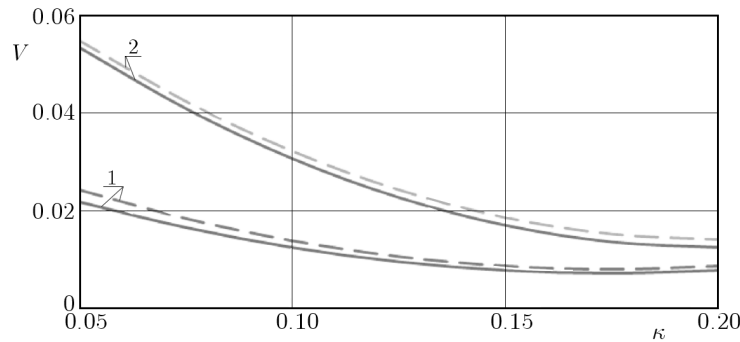

Fig. 7. The relationship between the weight functional  $V$  and the parameter  $\kappa$ ; 1 -  $\chi = 15^\circ$ ; 2 -  $\chi = 45^\circ$

### 5. Final remarks and conclusions

The foregoing deliberations related to the effect of basic physical parameters onto rigidity-related characteristics are in line with the engineering process of aircraft subassemblies by optimization of parameters that define geometrical features of aircraft bodies. Use of CAD/CAM/CAE Unigraphics system for description of the aircraft solid body, in particular the dedicated programming language incorporated into the system, made it possible to formally define the design algorithms and cut down the time that is necessary to make amendments to the defined geometry. Development of a parametrical model on the basis of initial values for the vector of parameters that define the object makes the job easier when it comes to development of a new model on subsequent phases of the engineering spiral. The parametrical model is derived from characteristic parameters that represent the geometrical boundary conditions for objects that undergo the modelling process. The imposed boundary conditions frequently enforce the need to change the approach to the engineering process during the phase when the model is to be defined within an integrated CAD/CAM/CAE system. The outlined considerations are intended to point new ways of the multi-criteria engineering process of an aircraft body with aid of an integrated design system. It must be noted here that the major benefits that are achieved due to application of integrated engineering systems are the following:

- possibility to develop dedicated software routines on the basis of the already defined parametrical models (F-16 aircraft);
- elimination of inconvenient improvements to geometrical features that extend the time necessary to develop a geometrical model during the initial phases of the engineering process (EM-11 'Orka' aircraft),
- reduction in the number of variables used for the process of model parameterization (steering system of MiG-29 aircraft),
- definition of rules for the functional relationship of indirect parameters involved in the engineering process (EM-10 'Bielik' and EM-11 'Orka' aircrafts).

The establishing of rules for reproduction and modification of objects makes it possible to change their geometry, while other parameters remain unaltered (weight, relative thickness, wing or body elongation, etc.) and may be imposed by the designer.

Components of the geometrical model serve as the basis to set up the aircraft structure that is indispensable to predict further improvements and evolution of the object, to carry out analyses of relationships between its geometry, weight, applied loads, strength and manufacturing technology.

## References

1. AMELJAŃCZYK A., 2009, Matematyczne aspekty modelowania pajęczynowego obiektów, *Biuletyn Instytutu Systemów Informatycznych*, **4**, 1-8
2. ASSELIN M., 1997, *An Introduction to Aircraft Performance*, AIAA Education Series, AIAA
3. BJÖRCK A., DAHLQUIST G., 1987, *Metody numeryczne*, PWN, Warszawa
4. BŁASZCZYK P., 1996, Numeryczne aspekty modelowania geometrii samolotu na potrzeby metod panelowych, *Zeszyty Naukowe Katedry Mechaniki Technicznej – XXXV Sympozjon Modelowanie w Mechanice*, **1**, Gliwice, 31-36
5. BOEHM W., 1984, *Efficient Evaluation of Splines*, Computing
6. BOCHENEK B., KRUŻELECKI J., 2007, *Optymalizacja stateczności konstrukcji, współczesne problemy*, Politechnika Krakowska
7. BRUSOV W., 1996, *Optymalne projektowanie wielozadaniowych statków latających*, Biblioteka Naukowa Instytutu Lotnictwa, Warszawa
8. CEA J., 1976, *Optymalizacja. Teoria i algorytmy*, WNT
9. DANILECKI S., 2000, *Projektowanie samolotów*, Oficyna Wydawnicza Politechniki Warszawskiej
10. Electronic Data Systems, 1999, *UG Computer Numerical Control*, Maryland
11. Electronic Data Systems, 1999, *UG Open Graphics Interactive Programming*, Maryland
12. GORAJ Z., SZNAJDER J., 1995, Metody panelowe w mechanice lotu - możliwości i ograniczenia, *Prace Instytutu Lotnictwa*, **143**, 4, 59-102
13. HANG E.J., 1978, Optimal design of dynamically loaded continuous structures, *Numerical Methods in Engineering*, **12**, 299-317
14. KACHEL S., 2008, *Application of the GRIP CAD/CAM/CAE Language for the Reverse Engineering Parametric Modelling Method of the Aviation Structures*, RRDPAE, ISSN: 1425-2104
15. KACHEL S., 2009, *Grafika inżynierska*, Wojskowa Akademia Techniczna, Warszawa
16. KICIAK P., 2000, *Podstawy modelowania krzywych i powierzchni*, wyd. I, WNT
17. LAWRYNOWICZ J., 1977, *Rachunek wariacyjny ze wstępem do programowania matematycznego*, WNT

18. MAJID K.I., 1981, *Optymalne projektowanie konstrukcji*, PWN
19. OLEJNIK A., 1996, *Aerosprężystość układów powierzchniowych*, X-Serwis Sp. z o.o.
20. OLEJNIK A., MARGAŃSKI E., JARZĘBIŃSKI L., KACHEL S., 2006, Analiza obciążeń samolotu EM-11 ORKA, Sprawozdanie z Projektu Celowego 6T12 2003C/06230
21. SIBILSKI K., 2004, *Modelowanie i symulacja dynamiki ruchu obiektów latających*, Oficyna Wydawnicza MH, Warszawa

### **Optymalizacja parametrów skrzydła minimalnej masy z uwzględnieniem ograniczeń do obciążeń aerodynamicznych**

#### Streszczenie

W artykule zaprezentowano metodykę optymalizacji parametrów w zastosowaniu do projektowania zespołów samolotu na przykładzie skrzydła skośnego. Przedstawiono główne założenia niezbędne do opracowania matematycznego modelu. Opisano ograniczenia będące podstawą do utworzenia algorytmu i opisanie procedur w języku GRIP (*Graphics Interactive Programming*) dla systemu CAD/CAM/CAE Unigraphics. Przeprowadzono dyskusję zmiany parametrów sztywnościowych i masy w zależności od ograniczenia obciążeniami aerodynamicznymi. Opracowano algorytm projektowania zespołów składowych samolotu z uwzględnieniem wejść do wielokryterialnego procesu projektowania *Web Modelling* bryły samolotu. W pracy zawarto założenia opracowanych przez autora i zastosowanych algorytmów modelowania elementów struktur lotniczych.

*Manuscript received March 16, 2012; accepted for print April 17, 2012*