

Clarification, Systematization and General Classification of Electronic Chart Systems and Electronic Navigational Charts Used in Marine Navigation.

Part 2 - Electronic Navigational Charts

A. Weintrit

*Gdynia Maritime University, Gdynia, Poland
Poland Branch of the Nautical Institute, UK*

ABSTRACT: In the article the author attempts to isolate, clarify, systematize, and classify various types and kinds of electronic navigational charts used in electronic chart systems, their specificity, operational status, significance and role they play. In particular he tries to promote internationally standardized vector charts ENC (Electronic Navigational Charts), and raster charts RNC (Raster Navigational Chart), as well as military Digital Nautical Charts (DNCs), High Density Bathymetric ENC (bENCs), Port ENC (PENCS), Inland ENC (I-ENCs), Three Dimensional Digital Nautical Charts (3DNCs) and others. He presents general classification of electronic charts data bases taking into account the following criteria: spatial dimension, data types (data format), official status, international standards, consistency, level of detail of bathymetry, data confidence (reliability, accuracy), navigational purpose, and indirectly also the compilation scale of the chart, size and arrangement of cells.

1 INTRODUCTION

The electronic navigation is becoming more and more common, especially on board merchant ships. Today's seafarer needs a tool with a similar standard of quality as the traditional standard paper chart (SNC), which, however, corresponds to the requirements of the new navigational era. The electronic charts provide significant benefits in terms of navigation safety and improved operational efficiency. The ECDIS (Electronic Chart Display and Information System) has become an important step in the development of shipping, which means the transition from paper to digital navigation (Weintrit, 2009). The ECDIS installation schedule came to the end in July 2018, therefore, more and more vessels (not only those under SOLAS convention) use electronic navigational charts as a basic way of navigation over a paper chart system. But what is the situation on the chart market? Unfortunately, even now after over thirty years of

developing international standards for ECDIS and electronic charts, there are still misunderstandings among the maritime community and not everything is clear and obvious. The confusion seems to be quite considerable among untrained seafarers, ship owners, chart distributors, and even among various authorities around the world. The author's intention is to dispel all these accumulated doubts.

2 ELECTRONIC NAVIGATIONAL CHARTS

An Electronic Navigational Chart (ENC) is a digital representation of paper charts, called now SNC (Standard Navigational Charts), a digital file containing all chart information necessary for safe navigation, as well as supplementary information required to plan voyages and avoid groundings (route planning and route monitoring). ENCs are

official vector-based electronic charts designed to meet the relevant chart carriage requirements of SOLAS convention. When displayed within certain parameters, and using a type approved ECDIS, ENC fully satisfy SOLAS chart carriage requirements, and so can be used as the primary means of navigation. ENC boasts electronic features that paper charts lack. For instance, a navigator can integrate GNSS/GPS data - which tells a navigator his precise position coordinates online in real time - with ENC data. Navigator can also integrate data from other Geographic Information Systems (GIS), real-time

hydro-meteorological data, like tide, current, and wind data to enhance ENC capabilities.

The inclusion of these functions can provide a more complete and accurate picture of marine environment. Vessel using ENCs can detect an obstruction in advance and check planned routes to avoid crossing hazardous areas. The electronic chart systems used to view ENCs can display alarms, warnings (indications) and regulations relating to areas in which a vessel passes, and can sound an alarm if the vessel is approaching the obstacle too much.

Table 1. Electronic Navigational Charts versus Paper Charts (Weintrit, 2009)

Paper Chart (SNC)	Electronic Chart (ENC)
fixed scale sheet, fixed North-up orientation (usually), fixed symbol definition, fixed symbol arrangement and application with respect to North, limited paper size, limited types and amount of information, limited number of colours and combined use.	fixed display size, fixed resolution, variable display scale, variable types and amount of information, various orientation with respect to North, various symbol arrangement and application, various symbol definition, various number and use of colours.

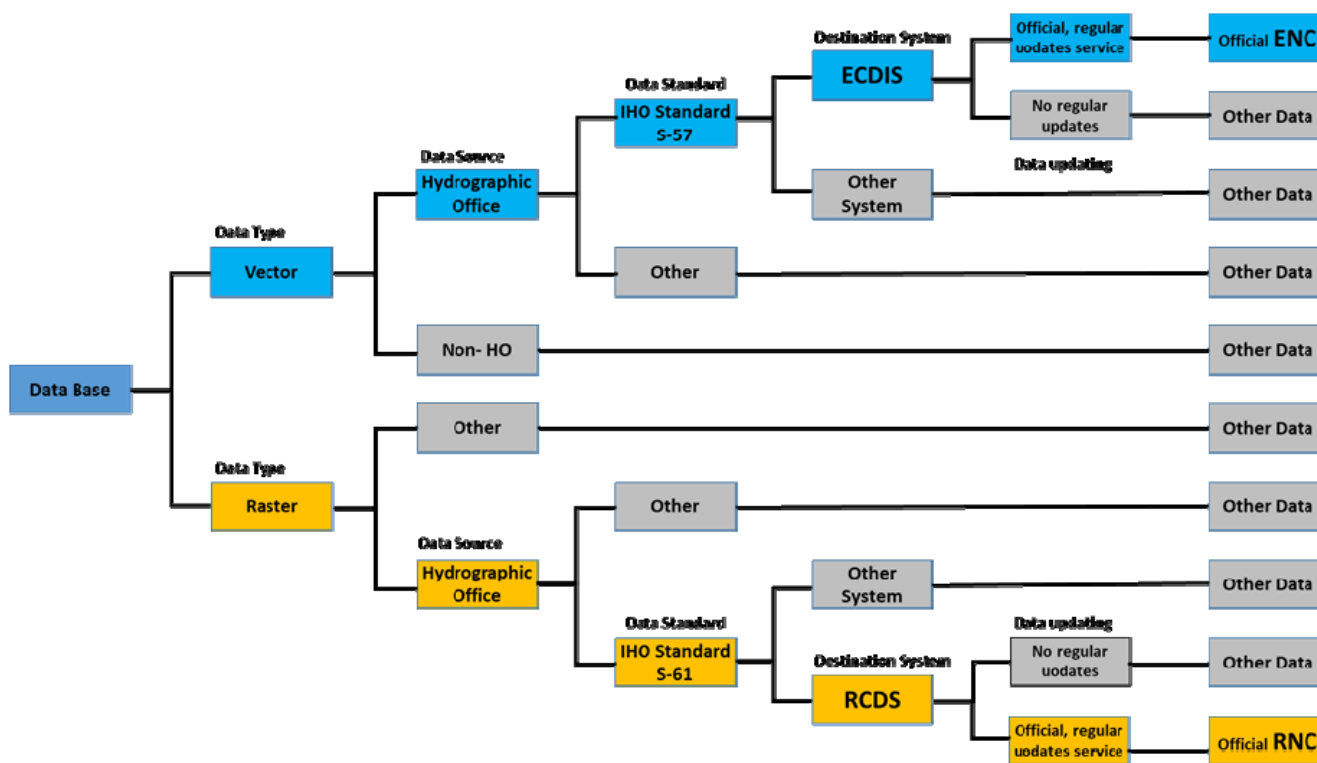

Figure 1. Classification of electronic chart data base aspiring to achieve the IMO official status of ENC and RNC (Weintrit, 2001 and 2009)

2.1 Different Types of Electronic Charts

Not all electronic charts are in same format; many different formats exist for electronic charts. However, two major types are now in use on merchant ships, they are vector charts and raster charts.

- Raster Charts. Raster chart is essentially an electronic picture of the familiar paper chart, obtained through an accurate, detailed scanning process. Raster charts therefore have exactly the same information as the paper chart. An example of raster charts are Raster Navigational Charts (RNCs) that conform to IHO specifications and are produced by converting paper charts to digital

image by scanner. The image is similar to digital camera pictures, which could be zoomed in for more detailed information as it does in ENCs. The IHO Special Publication S-61 provides guidelines for production of raster data.

- Vector Charts. Vector charts utilize a vector database to build the chart display. This data is stored in layers and records every nautical chart feature such as coastlines, buoys, depths, lights, etc. These features and their attributes such as position, color, size, shape, and others are stored in a database allowing them to be selectively displayed and interrogated. An example of vector

charts are Electronic Navigational Charts (ENCs) that are the chart databases for ECDIS, with standardized content, structure and format, issued for use with ECDIS on the authority of government authorized hydrographic offices. According to the IHO standards (IHO S-52, 2010; S-57, 2014) ENCs contain all chart information

necessary for safe navigation, and may contain supplementary information in addition to that contained in the paper chart. ENCs are intelligent, because systems using them can be programmed to give warning of impending danger in relation to the vessel's position and movement.

Table 2. Raster Charts versus Vector Charts

Raster Chart (RNC)	Vector Chart (ENC)
Chart data is a digitized "picture" of a chart (scanned chart). All data in one layer and one format. With raster data, it is difficult to change individual element of the chart since they are not separated in the data file. The depth units cannot be changed. There is no possibility to "hide" information on the map. Because raster charts perfectly match the paper charts, it is easy when underway to work back and forth between the wide view of large paper charts and the small section seen on an electronic screen. There is no need to learn for seafarers already familiar with paper charts.	Chart data is organised into many separate files. It contains layer information to produce certain symbols, lines, area, colours, and other elements. With vector data, it can change individual elements with additional data. Good display at any scale. Detailed information on specific objects of the chart (e.g. lights, buoys). Ability to configure charts and filter data. Less memory is required for storage. Zooming in and out makes movement between small- and large-scale charts unnoticeable and seamless. Vector charts have a "clean" look because they present less information on any one screen.

2.2 Data Source

In the late 1980s, the advent of the digital era created opportunity for private manufacturers who were keen to develop electronic chart systems (ECS) and proposed digital nautical charts generally obtained simply through digitizing the paper charts produced by HOs. Considering the liability aspects, the International Maritime Organization (IMO) adopted Performance Standards for ECDIS in 1995, modified in 2006 (IMO, 2006), which included a provision that the associated ENCs had to be issued 'on the authority of government authorized hydrographic offices'. This provision was refined in the amendments to the SOLAS Convention that were adopted in 2000 and entered into force in 2002. These amendments include a definition of a nautical chart or publication as 'a special-purpose map or book, or a specially compiled database from which such a map or book is derived, that is issued officially by or on the authority of a Government, authorized Hydrographic Office or other relevant government institution and is designed to meet the requirements of marine navigation.' (Regulation V/2.2). They include also the requirement that Governments undertake to arrange for the collection and compilation of hydrographic data and the publication, dissemination and keeping up-to-date of all nautical information necessary for safe navigation.' (Regulation V/9). This means that electronic charts (even in vector format) created by private chartmakers cannot receive status of official charts for SOLAS vessels.

2.2. Data Standard

An electronic navigational chart (ENC) is an official database created by a national hydrographic office for use with ECDIS. An electronic chart must conform to standards stated in the IHO Special Publication S-57 (IHO S-57, 2014) and S-52 (IHO S-52, 2010) before it can be certified as an ENC. Only ENCs can be used within ECDIS to meet the IMO performance

standards for ECDIS (IMO, 2006) and SOLAS Convention.

It is obvious that an official ECDIS service cannot be provided on a national level only, but requires co-operation of hydrographic services. The IHO decided to establish Worldwide Electronic Navigational Chart Data Base (WEND). IHO members states are encouraged to provide information concerning their online chart catalogues to the IHO Secretariat to keep Online Worldwide Chart Catalogue (Jonas and Weintrit, 2005).

ENCs are available through Regional Electronic Navigational Chart Coordinating Centres (RENCs) and national electronic chart centres: e.g. Primar (with perfect seamless ENC cells with similar density of chart details), IC-ENC (with British style ENCs with different density of details). Distributors like the United Kingdom Hydrographic Office (UKHO) then distribute these to chart agents.

The IHO adopted a digital chart standard - designated S-57 - which specifies the structure and format of ENCs. IMO's Performance Standards for ECDIS requires compatibility with S-57 ENCs in order for an ECDIS to be type-approved; this has made S-57 a de facto standard for vector charts. Because ENCs might be subject to unauthorized modification or illegal copying, the IHO has adopted S-63, the standard which define technical details for the particular method of encryption used, as well as operating procedures for charts display systems to use S-63 charts. An S-63 chart is simply a S-57 chart that has been encrypted.

The IHO standard S-57 ver.4, called IHO S-100 (IHO S-100, 2017), give completely new significantly expanded possibilities for the chart makers.

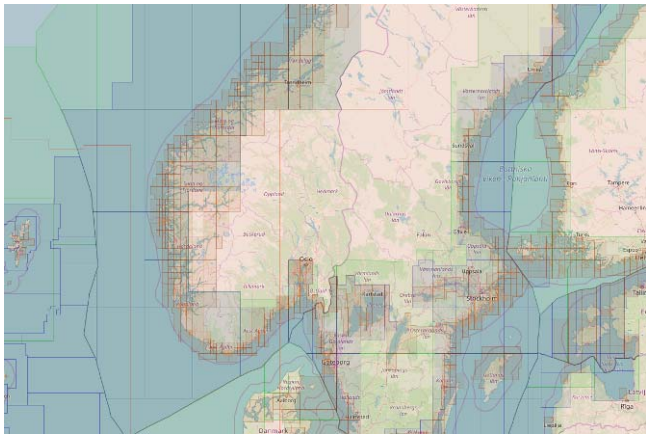

Figure 2. Norwegian (Primar) style seamless ENC cells (cell to cell), (Primar, 2018)

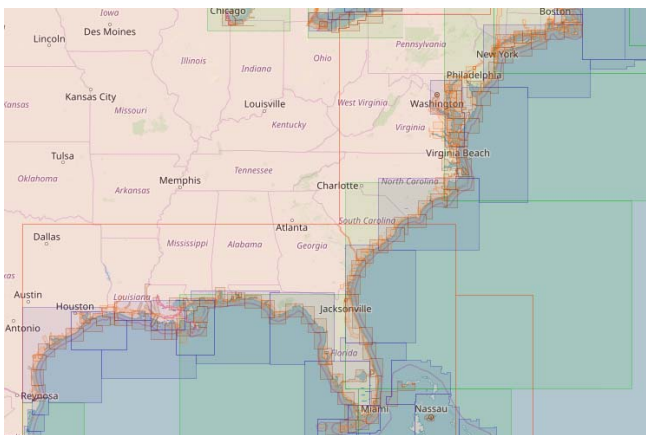
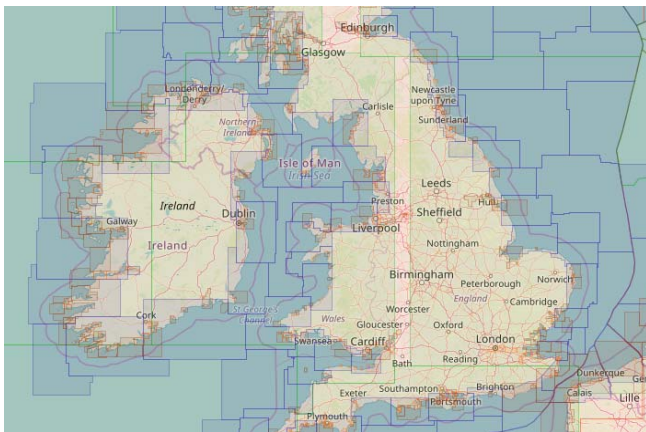

Figure 3. American/British style ENC cells (different size of cells – cell on cell), (Primar, 2018)

The existence of privately manufactured chart data is a fact. It is cost-effective and economically viable. Its volume is still increasing and it has proved to be meeting a demand of maritime market. The major data manufacturers (e.g. Transas with data format TX-97, C-Map by Jeppesen with data standard CM-93) offer a high quality and affordable means of world-wide navigation, sold through global network, including an easy to access the update service.

2.3 Destination System

Only ECDIS using the official ENC entitles to navigate without paper charts! ENCs are the only route to paperless navigation. ENCs are produced to the hydrographic standards S-57. In order to enjoy

official status as ENCs they must accord with the product specification and be up-to-date, thereby meeting IMO regulations for paperless navigation using ECDIS.

When relevant ENC chart information is not available in appropriate form, some ECDIS equipment may operate in the Raster Chart Display System (RCDS) mode using Raster Navigational Charts (RNCs).

2.4 Updating Service

If vessel operates with an electronic chart system, there is a need to keep the charts up-to-date (even if they should not be used as a primary means of navigation). For vessels operating with ECDIS, there is a legal requirement to keep the electronic charts as up-to-date as possible especially if this is your primary means of recording your navigation position. Updates to Electronic Navigational Charts should be issued by HOs at regular interval, for example weekly, and each paperless vessel should be provided with an official regular update service.

3 CONFUSION OVER THE CHARTS

The significant problem in the use of ECDIS lies in the charts to be used. The confusion appears to be symptomatic. You must use an ENC in order to use the system as an ECDIS. If no complete ENC coverage is available for the ships area of operations you have to use other available charts, and then your system will lose ECDIS status and turn into ECS.

When the ENC coverage was in the past very limited, it was difficult to get an overview over which parts of the world are covered by ENCs. It was merely stating the fact that the availability of ENCs was limited, and thus the possibility to use ECDIS in practice was limited. The confusion begins, when we start speaking about other less official types of vector charts than ENCs, and also about raster charts, including RNCs.

3.1 Production of the Navigational Charts

Production of official navigational charts has been an exclusive domain of the national Hydrographic Offices for a long time. The IMO specifies in SOLAS regulations that only the charts made by the HOs meet the carriage requirements for commercial shipping. Each ship must meet these requirements to be considered seaworthy by the appropriate authorities. Some are preaching controversial opinions that the time has come to start more trusting the privately produced commercial nautical charts to put them on the similar level as the official ones and to clarify the relevant liability issues (Buttgenbach, 2018). The most important thing is that the charts should be reliable, accurate and up-to-date. But is it really happening?

3.2 Non-Official Charts

Modern IHO standards such as S-44 (IHO S-44, 2008), S-57 (IHO S-57, 2014), S-100 (IHO S-100, 2017), and S-102 have made it possible to produce digital charts of unparalleled precision. It is a known fact that not only national HOs but also private chartmakers are capable to produce charts of high quality and reliability. The justification for the monopoly of the official charts was many times challenged more or less rightly (Malie, 2003; Buttgenbach, 2018; Di Lieto et al., 2018).

Today there is a number of alternatives to the official ENC, e.g. Navionics, Transas and Jeppesen (formerly C-Map) have almost worldwide coverage of vector charts where the data is based on existing paper charts. Unfortunately these charts have not obtained the status as official, because that they are private manufacturers and because of the frequency of the updates (usually monthly or quarterly) and the lack of a controlling authority to approve the contents.



Figure 4. Summary of ENCs: Official – Non-Official; Vector – Raster (Arts, 2003)

4 ENC NAVIGATIONAL PURPOSES

The concept of separating ENCs into usage bands provides data producers with a mechanism to create cells designed for six distinct navigational purposes, each having different levels of content (e.g. contour intervals) and degrees of generalization. Similar navigational purposes (see Table 3 below) are also used for paper chart series.

Table 3. ENC Navigational Purposes – ENCs Bands

Subfield Content / Bands	ENC Navigational Purpose	Compilation Scale Range
1	Overview	< 1 : 1 500 000
2	General	1 : 180 000 ÷ 1 : 1 500 000
3	Coastal	1 : 45 000 ÷ 1 : 180 000
4	Approach	1 : 22 000 ÷ 1 : 45 000
5	Harbour	1 : 4 000 ÷ 1 : 22 000
6	Berthing	> 1 : 4 000

According to the IHO report, in 2016 the global coverage of the ENCs was the following: for the

Bands 1 & 2 = 100%, for Band 3 = 93%, and for Bands 4, 5 & 6 = 98%. For paper charts SNCs (Standard Navigational Charts) the coverage was almost the same.

The observations presented below are based on the supposition that most ENCs were derived from paper charts and therefore have similar characteristics in terms of content, generalization and coverage. It is assumed that ENCs compilation scale is comparable its source chart scale and its cells limits approximate those of the source paper chart.

The scales selected for port approach, harbour and berthing paper charts, are largely dependent on factors such as the available source data, the size of the harbour and the extent of the port area. Because these factors vary depending on the port, the scales and chart coverage may vary accordingly. Similarly coastal charts (usage band 3) also need to take into account additional factors such as the nature of coastal area and density of shipping. Therefore, the scales and ranges selected for these charts may also vary depending on the area. Small scale charts and ENC cells often extend beyond national charting limits and provide extensive coverage of the high seas. Their content is usually reduced to significant navigational features, and is often highly generalized. The compilations scales chosen for these products are not as heavily influenced by littoral coastal conditions and therefore provide an opportunity for the development of harmonized, consistent world wide chart coverage.

5 RELIABILITY OF THE CHARTS

5.1 Accuracy of the Nautical Charts

Navigational charts are basic source of information for seafarers. They are essential tools for marine navigation. But how accurate are the navigational charts that we use when sailing? All charts, whether paper or electronic, contain data of varying quality due to the age, accuracy, reliability and completeness of individual surveys. Until now, it was not easy to assess the reliability of a chart, one had to rely on declarations of the Hydrographic Offices (the reliability diagrams for example) or of chartmakers in general. A chart can be treated as a puzzle of individual surveys pieced together to form a single image. Most charts contain a mixture of surveys of varying quality. In general, remote areas away from shipping routes are less frequently surveyed, while areas of high commercial traffic are often reviewed with very high accuracy and completeness, especially where under-keel clearances are small. However, the majority of coastal and international shipping routes are somewhere between these two standards, where risks and choices are less well defined. To assess these threats, seafarers have traditionally relied on known, but often ambiguous indicators used on paper charts, usually in a source diagram or currently in ZOC diagram. Details and interpretations often differed greatly between HOs. Differences in method, detail and interpretation render this type of quality information unsuitable for use in an electronic system such as ECDIS, as it prevents use of automated checking routines to look along a planned route to

confirm suitability. To solve this problem, the IHO developed and published an international system used by all nations within its S-57 ENCs. This is the “Zones of Confidence” (ZOC) system. The degree of reliance which can be placed in the depth information within an ENC can be consistently determined by understanding the ZOC assessment for an area, then applying a common-sense approach.

The Standard Display, which is also a pre-arranged chart display, but which can be modified by the operator, and which is automatically shown when the ECDIS is first switched on. It contains the display base plus boundaries of channels etc., conspicuous features, restricted areas, chart scale boundaries and cautionary notes.





5.2 Zones of Confidence (ZOC) Categories

There are five basic levels within the ZOC system (Table.4). Each differing level of quality is referred to

as a ‘category’ within the overall ZOC system. Each category is therefore labelled as ‘CATZOC’ when queried within the ENC. The categories range from ‘very high confidence’ to ‘unsurveyed’. There is also an additional category for ‘Unassessed’.

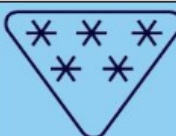
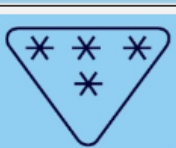
Thus, put in simple terms, electronic charts are not the same, they differ greatly in the density and quality of presenting information. Seafarers should be able to navigate with confidence in areas with ZOC A1 and A2 classifications. It is also unlikely that an uncharted danger affecting surface navigation exists in ZOC B areas. In ZOC C areas seafarers should exercise caution since hazardous uncharted features may be expected, particularly in or near reef and rocky areas. A very high degree of caution is required for areas assessed as ZOC D, as these contain either very sparse data or may not have been surveyed at all. Finally, it is good practice to treat ZOC U areas with the same degree of caution as ZOC D areas.

Table 4. Zones of Confidence (ZOC) Categories (IHO S-57, 2014; Weintrit, 2018; Rutkowski, 2018)

ZOC	Position Accuracy	Depth Accuracy		Seafloor Coverage	Typical Survey Characteristics	Symbol
A1	± 5m	=0.50 + 1% <i>d</i>		Full area search undertaken. Significant seafloor features detected and depths measured.	Controlled, systematic survey high position and depth accuracy achieved using DGPS or a minimum three high quality lines of position (LOP) and a multibeam, channel or mechanical sweep system.	
		Depth [m]	Accuracy [m]			
		10	± 0.6			
		30	± 0.8			
		100	± 1.5			
1000	±10.5					
A2	± 20m	=1.0 + 2% <i>d</i>		Full area search undertaken. Significant seafloor features detected and depths measured.	Controlled, systematic survey achieving position and depth accuracy less than ZOC A1 and using a modern survey Echosounder and a sonar or mechanical sweep system.	
		Depth [m]	Accuracy [m]			
		10	±1.2			
		30	± 1.6			
		100	± 3.0			
1000	± 21.0					
B	± 50m	=1.0 + 2% <i>d</i>		Full area search not achieved; uncharted features, hazardous to surface navigation are not expected but may exist.	Controlled, systematic survey achieving similar depth but lesser position accuracy less than ZOC A2 and using a modern survey echosounder, but no sonar or mechanical sweep system.	
		Depth [m]	Accuracy [m]			
		10	±1.2			
		30	± 1.6			
		100	± 3.0			
1000	± 21.0					
C	± 500m	=2.0 + 5% <i>d</i>		Full area search not achieved, depth anomalies may be expected.	Low accuracy survey or data collected on an opportunity basis such as soundings on passage.	
		Depth [m]	Accuracy [m]			
		10	±2.5			
		30	± 3.5			
		100	± 7.0			
1000	± 52.0					
D	Worse than ZOC ‘C’	Worse Than ZOC ‘C’		Full area search not achieved, large depth anomalies may be expected.	Poor quality data or data that cannot be quality assessed due to lack of information.	
U	Unassessed - The quality of the bathymetric data has yet to be assessed.					

**In practice, it is usually assumed that the reliability error of bathymetric data measurements estimated for ZOC (D) and ZOC (U) zones assumes values at least 10% higher than the values estimated for the ZOC zone (C), which can also be recorded as: (2.0m ± 5% · d) · 1.1.*

5.3 Analysis of the Reliability of Coastal ENCs

To put this in perspective, the Table 5 is an overall analysis of over 14 million square kilometres of coastal ENCs from 32 nations (IHO S-67, 2017). The analysis did not include ports and harbours. What may be surprising, according to a report prepared by the IHO S-67, in coastal shipping areas the most common assessments likely to be encountered are the following:

- Zone of Confidence (ZOC) B – around 30% of the world’s coastal waters,
- ZOC C – around 20% of the world’s coastal waters,

- ZOC D – around 20% of the world’s coastal waters, and
- ZOC U – around 25% of the world’s coastal waters.

It means that only less than 5% of the world’s coastal waters falls into the category A1 or A2 (Weintrit, 2018). Thus, it should be clear that a firm understanding of the implications of each confidence level should be important for planning the safe navigation of a vessel.

As we can see the situation in the most busy maritime water areas (e.g. in English Channel) looks no so bad, but it is very far to be perfect, the B category dominates, areas covered by categories A1 and A2, unfortunately, do not impress. But what about the rest of the world then? Although these percentages may vary from place to place, the key point is that the standards of surveying in ports are only very rarely encountered outside those ports.

Therefore, ships are at greatest risk away from ports, even though depths may be deeper. An understanding of how much confidence can be placed in the data within an ENC is therefore the most important. Do we need to revert to paper charts in areas where the ENC Category Zone of Confidence is set to C or less? No, we don't. The same data is used for a paper charts and ENCs, so they are not more accurate than others.

Table 5. Sea Areas Covered by ENCs with Information on the ZOC Category (IHO S-67, 2017)

Category	% area of English Channel	% area of Singapore & Malacca Straits	% area of world's coastal ENC (32 nations)	Confidence
A1 (6 stars)	3.6%	1.4%	0.7%	Very Good
A2 (5 stars)	9.4%	0.2%	1.0%	Very Good
B (4 stars)	62.9%	2.5%	30.5%	Good
C (3 stars)	21.3%	76.2%	21.8%	Fair
D (2 stars)	2.8%	1.1%	20.5%	Low
Unassessed (U)	0.0%	18.5%	25.4%	Low

6 BATHYMETRIC ENCS IN CONFINED WATERS

Hydrographic Offices have realised that bathymetric data is not sufficiently represented in ENCs. Electronic charts with greater scale and bathymetric content than any Hydrographic Office's ENC are not a novelty for many ports around the world. Such charts are normally produced by Port Authorities and are used by marine pilots on the Portable Pilot Units (PPU). Some HO's experimented with High Density (HD) Bathymetric Electronic Navigation Charts (bENCs) for ports. These ENCs – like any other official ones – could be available both to ships' crew using ECDIS and to Marine Pilots' PPUs (Di Lieto et al., 2018; Moggert-Kageler, 2018).

effects of hull-seabed interactions. This was not possible by looking only at harbour ENC's dredged areas that usually cover most of the confined waters with single maintained depth values. These two concepts bring ENCs to exceed the mere equivalence to paper charts and to take full advantage of high accuracy electronic navigation systems to monitor real-time ship's position and heading when safety margins are tight. It is essential that bathymetric ENCs become available to both ECDIS and PPUs users because the risk of ever decreasing safety margins to conduct vessels in confined waters requires the ship's crew to be on the same page with the marine pilot, especially when safety margins are small (Di Lieto et al., 2018).

6.1 High Density Bathymetric ENCs (bENC).

The first innovation of High Density Bathymetric ENCs is about giving the possibility to visualise safety margins with higher resolution than a standard harbour ENC. The second innovation of bENCs is about providing more detailed information on deep soundings within navigable areas, which is an important piece of information to anticipate the

High Density Bathymetric ENCs can be created and maintained in S-57 format. The challenge is to understand potential and constraints of existing IHO standards. Among High Density Bathymetric ENCs (bNEC), we can distinguish several other groups of charts on the needs and purpose, among others Port ENCs, Precise ENCs, Inland ENCs, etc. According to Seefeldt (2011) the Port ENC standard should be an independent but complementary to standard of maritime ENC and Inland ENC (see Fig.5 and 6 below).

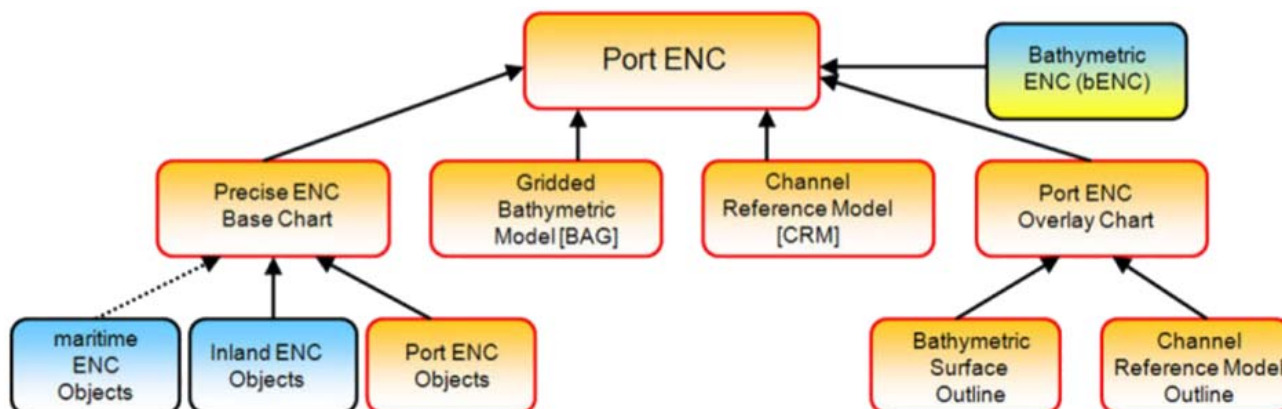

Figure 5. The Port ENC components (Seefeldt, 2011)

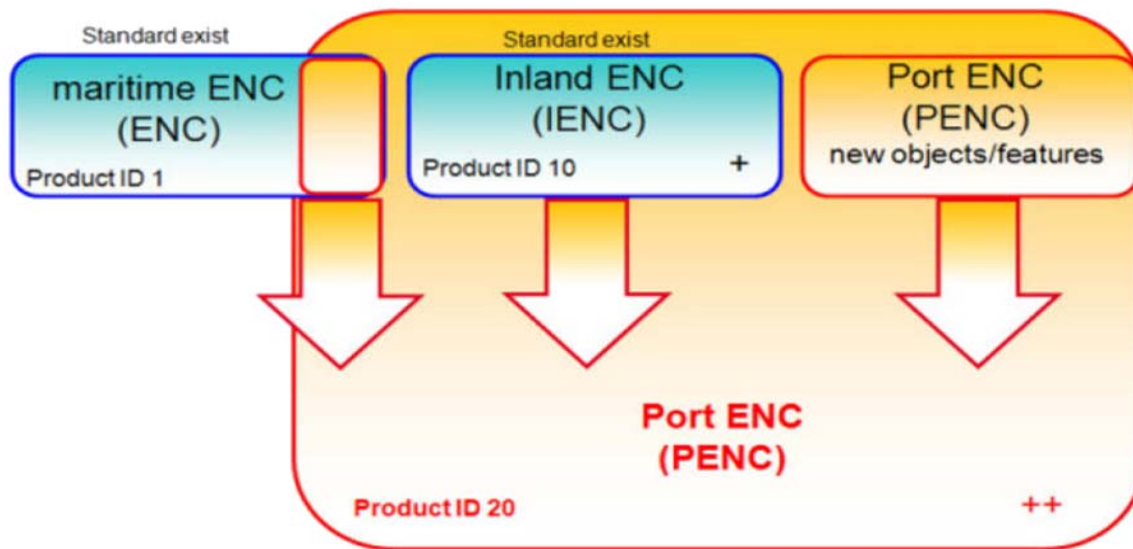

Figure 6. ENC gradation including the Port ENC (Seefeldt, 2011)

6.2 Research Instrument

Because most of the national HO's only produce Electronic Navigation Charts for harbour usage, some ports investigated the possibility of producing 'Berthing' ENCs containing high density depth data to support decision-making within the port. For example, the Port of Rotterdam started a pilot project to produce S-57 ENCs of the area covered by the port more than ten years ago. The goal of this project was to produce daily high density ENC updates that incorporated daily hydrographic surveys of the area. It took a few years to take the high density ENC into production due to many conversion tools that had to be developed and performance problems in creating depth areas at a contour interval of only 10 cm (Di Lieto et al., 2018).

7 OTHER TYPES OF DIGITAL CHARTS

7.1 Electronic Navigational Chart (ENC) with Additional Military layers (AML) for WECDIS use

The concept of additional military layers (AML) was introduced in 1995 with the intent to define a standardized format for non-navigational data. Since that time, various North Atlantic Treaty Organization (NATO) standardization agreement documents concerning AML data and Warship Electronic Chart Display and Information Systems (WECDIS) have been created. Using precise military integrated navigation system the sophisticated electronic chart system designed to meet the specific navigational demands of the military market, the strengths and weaknesses of how AML data interacts with other data types, primarily ENC data, within the WECDIS were identified. We might also consider referring to the concept of Marine Information Overlays (MIO) which have been used in the Marine Electronic Highway project, and whose use are gathering support within the e-Navigation discussion.

7.2 Digital Nautical Chart (DNC)

The largest of the non-S-57 format databases is the Digital Nautical Chart (DNC) produced according to

a military specification. The DNC is a vector-based digital product that portrays significant maritime features in a format suitable for computerized marine navigation. The DNC is a general purpose global database designed to support marine navigation and Geographic Information System (GIS) applications. DNC data is only available to the U.S. military and selected allies. It is designed to conform to the IMO Performance Standard and IHO specifications for ECDIS.

What is the difference between DNC and ENC? DNC and ENC charts are "vector" charts where the data can be found in layers which can be overlaid onto a display. A Digital Nautical Chart (DNC) is produced by NGA in accordance with DIGEST C Vector Product Format (VPF). While both ENC and DNC are vector charts, they have different spatial data models. An ENC has two layers (skin of the earth and everything else), while a DNC has 12 layers of information. An ECDIS must transform the ENC into a "System" ENC (SENC) for use. This essentially means full topology must be constructed from the less complete chain-node topology of the ENC. DNC is topologically complete, i.e. all 12 layers of information are fully attributed, and can be "directly read" by WECDIS or ECDIS-N (ECDIS Navy).

7.3 Offshore Electronic Navigational Chart

In offshore mining industry, such as Offshore Oil & Gas, Exploitation of the Seabed, Telecommunications, Fishing, Aggregate Extraction, Diving, sometimes are used three dimensional digital nautical charts 3DNCs. In Dynamic Positioning System are used either two dimensional ENCs or 3DNCs. Sometimes it is convenient to present some details in a spatial way.

7.4 Three Dimensional Digital Nautical Charts (3DNC)

The multibeam seafloor mapping technology makes it possible for the first time to map and to reveal all hazards to navigation with high confidence. If taken into use for shallow water areas with significant traffic density such as port entrances, ports, rivers and

other inland waterways, it can mean a significant increase in the safety for shipping. For ports, the multibeam technology can be helpful for minimising the coast of dredging. It can also be used for efficient inspection of breakwaters, bridge foundations and other manmade constructions and for locating debris on the bottom. For surveying of canals and rivers, the increase in efficiency is very substantial, since the survey lines are now parallel to the shoreline. The 3DNC is most probably the next step in ENC development.

7.5 Inland Electronic Navigational Chart (I-ENC)

Inland ENCs (I-ENCs) are official digital vector charts produced by inland waterway authorities in accordance with the IHO's product specification S-57, extended for use on inland waterways. Inland ENC (I-ENC) means the database, standardized as to content, structure and format, issued for use with Inland ECDIS. Inland ENC complies with the IHO standards S-57 and S-52, enhanced by the additions and clarifications of this standard for Inland ECDIS. The Inland ENC contains all essential chart information and may also contain supplementary information that may be considered as helpful for navigation (Weintrit, 2010). I-ENCs follow the IHO S-57 data exchange standard, which is recognized by software vendors and government hydrographic offices for electronic chart applications. Because of the technical similarity between I-ENCs and SOLAS ENCs, both can usually be displayed on both ECDIS and inland navigation systems. However, the inland I-ENC standard is a superset of the ENC standard. Therefore, an ECDIS system will not normally display inland waterway specific objects and symbols correctly.

8 NEXT GENERATION ENC S-101

8.1 IHO Standard S-100

After more than two decades of using IHO S-57 data for navigation, the time has come for a new standard, more versatile, with agile development and constant evolution, which can address today's navigational and non-navigational needs; according with international geospatial standards, integrated with the GIS world. These are inherited characteristics from the S-100 Universal Hydrographic Data Model (IHO S-100, 2017) into the S-101 Product Specification for Electronic Navigational Chart data. After the use of a "semi-frozen" and rigid S-57 specification, the objective is to replace it with S-101. Although this new specification is a big step into modernity, it does not represent a radical departure from its predecessor; it keeps many of the S-57 attributes and enhancing elements while complying with ISO geospatial standards, which will make these data sets very useful in spatial data infrastructures, GIS and e-Navigation (Weintrit, 2011). The intention is not to develop IHO S-101 in a vacuum, but to actively solicit input from software and equipment manufacturers and the ultimate end-user: the seafarer. The Standard

Display, which is also a pre-arranged chart display, but which can be modified by the operator, and which is automatically shown when the ECDIS is first switched on. It contains the display base plus boundaries of channels etc., conspicuous features, restricted areas, chart scale boundaries and cautionary notes.

8.2 Dynamic ENC Content

The great advantage S-101 will have over the existing S-57 ENC product specification is the introduction of dynamic, machine readable feature and portrayal catalogues. The term dynamic is used to indicate the ability to support evolutionary change in an almost continuous way without impacting on existing users. While similar in content to the current S-57 object catalogue and the S-52 presentation library, IHO S-101 will implement the dynamic constructs prescribed by S-100. In S-101, the relationship between features, attributes and enumerates are defined within a single feature catalogue. Although, part of the standard, the feature catalogue will be built through reference to the registry that provides the definition of the data content in a machine readable form, thus allowing ECDIS to easily update on board systems via a straightforward software update.

Another future-proof solution may be dynamic electronic navigational charts, changing the content of the chart in time, e.g. changing the course of the isobaths (contour lines) on the chart, taking into account the dynamic phenomenon of tides.

9 SYSTEM ELECTRONIC NAVIGATIONAL CHART (SENC)

A SENC is an acronym for System Electronic Navigational Chart. An ECDIS converts ENC data into its own internal SENC format for optimal chart image creation. SENC data can differ between manufacturers. The System Electronic Navigational Chart (SENC) means a database resulting from the transformation of the ENC by ECDIS for appropriate use, updates to the ENC by appropriate means and other data added by the seafarer. It is this database that is actually accessed by ECDIS for the display generation and other navigational functions and is the equivalent to an up-to-date paper chart.

In 2006 the IMO modified a little the definition of the SENC: System Electronic Navigational Chart (SENC) means a database, in the manufacturer's internal ECDIS format, resulting from the lossless transformation of the entire ENC contents and its updates (IMO, 2006). This slight correction of wording in SENC definition allowed the bypassing of existing arrangements and the emergence of such seemingly exotic ties as C-Map (Jeppesen) with NHS as well as British Admiralty (UKHO) with Transas - TADS (Transas Admiralty Data Service). Thus a new ENC with the status of SENC appeared on the market. The perception of what is official vector data also definitely was changed (Fig.7).

What is Official Vector Data?

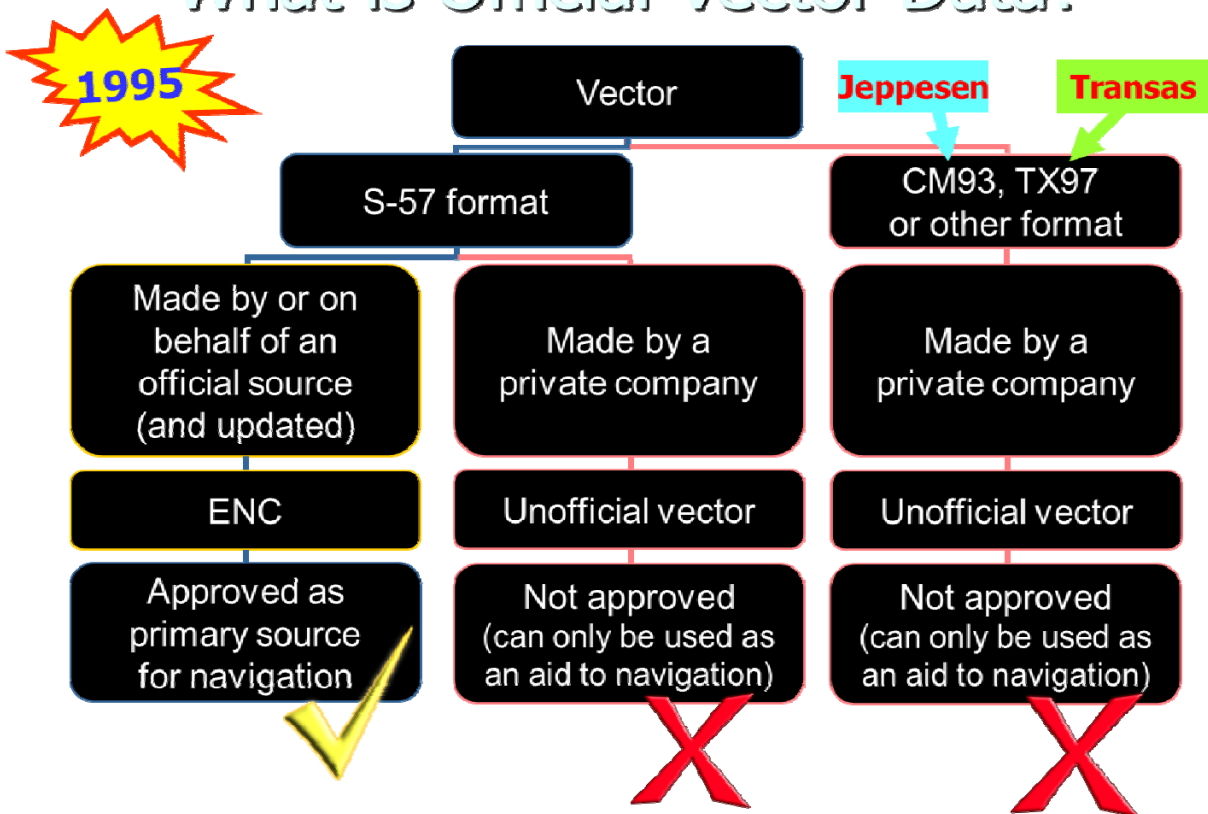

What is Official Vector Data?

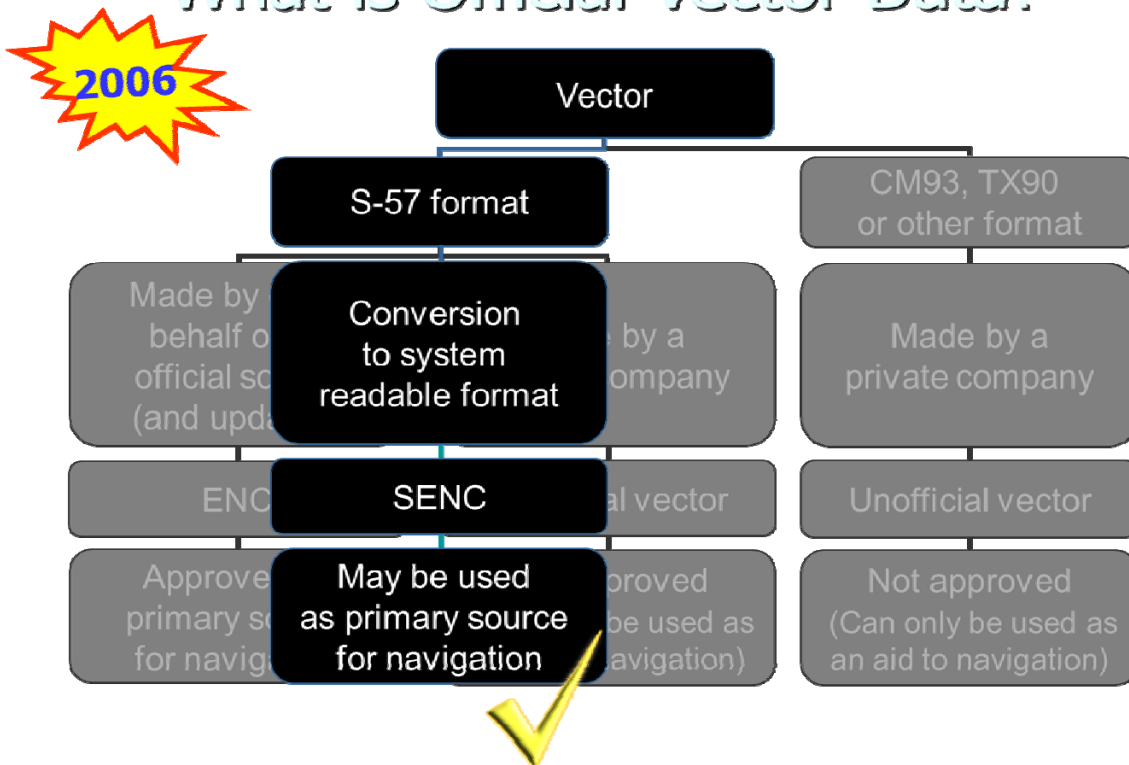

Figure 7. What should be considered as official vector data now and what should have been considered official data after 1995 until 2006 (Weintrit, 2009)

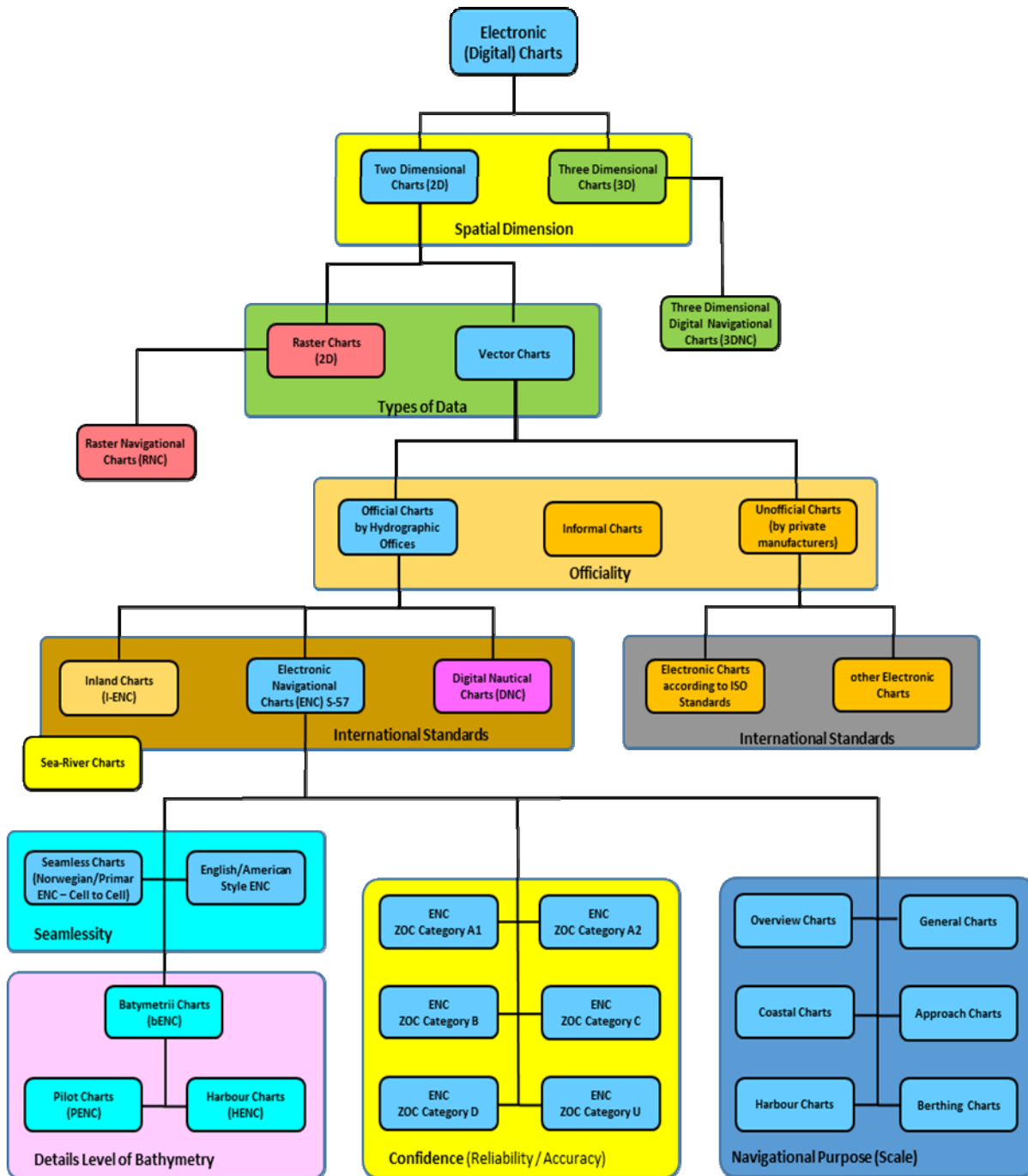

Figure 8. General classification of the electronic charts taking into account various criteria, among others: spatial dimension, types of data (data format), officiality, international standards, seamlessness, detail level of bathymetry, presentation of details, data confidence (reliability, accuracy), navigational purposes and indirectly also the compilation scale of the chart and cell size

In order to get efficient data structures that facilitate the rapid display of ENC data, most ECDIS convert each ENC dataset from S-57 into an internal machine-language format called SENC or System ENC – which is optimised for chart image creating routines. Most ECDIS software manufacturers have their own SENC format. In order to take advantage of the efficiencies of delivering ENC data in a SENC format, the IHO has authorised an optional distribution mechanism called SENC delivery. This is in addition to the standard distribution of ENC in S-57 format. In this case, a RENC delivers the S-57 based ENCs to an authorized chart data distributor who then performs an ENC-to-SENC conversion, and delivers the resultant SENC to the end user. However, it is up to individual Hydrographic Offices decision.

Not all Hydrographic Offices allow their ENCs to be delivered by distributors as SENCs (IHO S-66, 2018).

10 CONCLUSIONS

A Electronic Navigational Charts have improved the safety of navigation and the efficiency of operations for seafarers who have welcomed digital technology positively. The delivering a portfolio of nautical charts covering the waters of a country is no longer an end in itself but one of the many applications of a national marine spatial data infrastructure that must be considered as a public good. There is no doubt that in the years to come the volume of ENCs will

increase. However, it is very unlikely that ENC's will ever have a 100% world-wide coverage. Hence the chance for private chartmakers. It seems that the private sector can and should play a major role in developing tools to manage efficiently that data base as well as in inventing and developing a variety of value-added products and services derived from that infrastructure. But as long as shipping remains a significant component of the world trade infrastructure, there will continue to be a substantiated need for 'official' nautical charts.

Unfortunately, most navigational charts are an amalgamation of geospatial information collected using different techniques at different times. We should be aware of this and always remember that ENC's do not always mean New! ENC's that are on the market today do not always depict the real world as accurately as would be desired. ENC's (and paper charts) are compiled from multiple data sources, some modern and comprehensive, some old (even ancient) and others from all stages in between. Unfortunately CATZOC's was not well understood, not liked, nor allowed seafarers to adequately make decisions based on data quality. Because of these problems and despite the effort and resources dedicated by HOs to populate CATZOC, the IHO has agreed that it will not be used in the future S-101 ENC product specification. The new indicators have to be useful and easy for the seafarer to understand (Powell, 2011). The next-generation services for ports, e.g. bENC, distributed using IHO S-100 based standards should be a leading trend on the market, because they have great value for the navigation community, improving the safety and efficiency of ships.

The clarification and general classification of electronic navigational charts used in marine navigation was presented in this article taking into consideration the following criteria: spatial dimension, types of data, officiality, international standards, seamlessness, detail of bathymetry, data confidence (reliability), navigational purposes (chart scale/cell size), and mutual spatial layout of the chart cells.

REFERENCES

- Arts, G. (2003). A Chart Distributor Perspective. The failure of ECDIS versus the apparent success of ECS. *HydroInternational*, Vol. 7, No. 2, March.
- Buttgenbach, G. (2018). How Blockchain Will have an Impact on Navigation. *Hydro International*, Vol. 22, No. 2, March/April.
- Di Lieto, A., Prince, M., Sanchez A. (2018). Bathymetric ENC's in Confined Waters. *Hydro International* Vol. 22, No. 3, May/June.
- IHO S-44, (2008). IHO Standards for Hydrographic Surveys. International Hydrographic Organization, Monaco, February.
- IHO S-52, (2010). Specifications for Chart Content and Display Aspects of ECDIS. Edition 6.0. International Hydrographic Organization, Monaco, March.
- IHO S-57, (2014). IHO Transfer Standard for Digital Hydrographic Data. Supplement No. 3 to Edition 3.1, International Hydrographic Organization, Monaco, June.
- IHO S-66, (2018). Facts about Electronic Chart and Carriage Requirements. Edition 1.1.0, International Hydrographic Organization, Monaco, January.
- IHO S-67, (2017). Mariners' Guide to Accuracy of Electronic Navigational Charts (ENC). Edition 0.4, International Hydrographic Organization, Monaco, April.
- IHO S-100, (2017). Universal Hydrographic Data Model. Edition 3.0.0. International Hydrographic Organization, Monaco, April.
- IMO MSC.232(82), (2006). Revised Performance Standards for Electronic Chart Display and Information Systems (ECDIS). International Maritime Organization, London, 5 December
- Jonas, M., Weintrit, A. (2005). IHO On-Line Navigational Chart Catalogue. Proceedings of the 6th International Symposium on Navigation. Gdynia Maritime University, Gdynia, Poland.
- Malie, C. (2003). ENC or Privately Manufactured Data. One or The Other or Both? *Hydro International*, Vol. 7, No. 2, March.
- Moggert-Kageler, F. (2018). New Challenges for Digital Chart Production. *Hydro International*, Vol. 22, No. 4, July/August.
- Powell, J. (2011). The New Electronic Chart Product Specification S-101: An Overview. *TransNav, the International Journal on Marine Navigation and Safety of Sea Transportation*, Vol. 5, No. 2, pp. 167-171.
- Primar (2018). <https://primar.ecc.no/primar/portal/ccw/> - Primar Chart Catalogue.
- Rutkowski G. (2018). ECDIS Limitations, Data Reliability, Alarm Management and Safety Settings Recommended for Passage Planning and Route Monitoring on VLCC Tankers. *TransNav, the International Journal on Marine Navigation and Safety of Sea Transportation*, Vol. 12, No. 3, pp. 483-490.
- Seefeldt, D. (2011). Enhance Berth to Berth Navigation Requires High Quality ENC's - The Port ENC - a Proposal for a New Port Related ENC Standard. *TransNav, the International Journal on Marine Navigation and Safety of Sea Transportation*, Vol. 5, No. 2, pp. 163-166.
- Weintrit, A. (2001). The Electronic Chart Systems and Their Classification. *Annual of Navigation* No. 3/2001, Gdynia, Poland.
- Weintrit, A. (2009). Handbook on Operational Use of ECDIS, A Balkema Book, CRS Press, Taylor & Francis Group, Boca Raton, London, New York, Leiden.
- Weintrit, A. (2010). Six in One or One in Six Variants. Electronic Navigational Charts for Open Sea, Coastal, Off-Shore, Harbour, Sea-River and Inland Navigation. *TransNav, the International Journal on Marine Navigation and Safety of Sea Transportation*, Vol. 4, No. 2, pp. 165-177.
- Weintrit A. (2011). Development of the IMO e-Navigation Concept - Common Maritime Data Structure. In: J. Mikulski (ed.) TST 2011, Communications in Computer and Information Science, vol. 239. Modern Transport Telematics. Springer, Berlin, Heidelberg, pp. 151-163.
- Weintrit, A. (2018). Accuracy of Bathymetric Data in the Electronic Navigational Charts. *Scientific Journals of the Maritime University of Szczecin*, No. 55 (127).