



SIMULATIONS AND MEASUREMENTS OF EDDY CURRENT MAGNETIC SIGNATURES

Paweł Polański, Franciszek Szarkowski

Maritime Technology Center S.A., Arenda Dickmana 62 Str., 81-109 Gdynia, Poland; e-mail: {pawel.polanski; franciszek.szarkowski}@ctm.gdynia.pl

ABSTRACT

Eddy current magnetic signature is, together with magnetization of ferromagnetic hull, mechanisms and devices on board, corrosion related and stray field sources one of the main sources of ship's magnetic signature. Due to roll, pitch and yaw of the ship in external magnetic field, eddy currents are induced in conducting materials on board ship, mainly in conducting hull. Flow of those currents is a source of magnetic field around a ship. Principal eddy current component is related to roll movement as it depends on rate of change of external field which is the highest for roll. Induced currents have both in-phase and quadrature components. Magnitude of the eddy current magnetic field can have significant effect on total magnetic field signature after degaussing for ships such as mine sweepers and mine hunters. Paper presents calculations and simulations as well as measurements of model and physical scale model made of low magnetic steel performed in Maritime Technology Center. Contribution of eddy current magnetic field in total field in low roll frequencies has been estimated.

Key words:

ship's magnetic signature, eddy currents, degaussing system (DG), physical scale model.

Research article

© 2018 Paweł Polański, Franciszek Szarkowski
This is an open access article licensed under the Creative Commons
Attribution-NonCommercial-NoDerivatives 4.0 license
(<http://creativecommons.org/licenses/by-nc-nd/4.0/>)

INTRODUCTION

Four main sources of ship's magnetic field signature within dc to several hundred Hertz band are:

- permanent and induced magnetization of hull and on board equipment;
- eddy currents induced in conducting hull and equipment;
- corrosion related and cathodic protection processes;
- electric equipment and ship's power distribution system.

The most important source is magnetization of ferromagnetic objects, which is best known, thoroughly described and successfully modelled and minimized. Fourth of the sources — stray field — is also well known and described and minimization methods, such as screens, appropriate cable routing or using special coils are commonly used. Lesser known is corrosion related magnetic field (CRM) and with passive and active ways of its reduction. Also its fall off rate is different than that of coils or magnetized sources (fall off is r^{-2} compared to r^{-3}) [10, 12, 13].

Second most important source of magnetic field are eddy currents induced in conducting hull and equipment on board. There is limited literature available on the topic, with main publications being those of J. J. Holmes [10, 12, 13], which are references in many articles about sources of ship's magnetic field signature. More detailed description of the topic is available from the same author in Electromagnetic Silencing Symposium 2012 (EMSS) article [11]. There are also several interesting publications about eddy currents in conducting objects that are not directly related to ship's signature. Recently (in 2016) another article with summary of RIMPASSE trials was published (measurements of physical fields of the vessel and their variation due to different conditions in several location in Europe and Canada) — this time concentrating on eddy current magnetic field [2, 9].

Theoretical introduction into eddy current magnetic field and related issues are presented below. Due to roll, pitch and yaw of the ship in external magnetic field, eddy currents are induced in conducting materials on board, including hull. Flow of those currents is a source of magnetic field around ship. Dominating component is related to roll frequency, which is usually the highest from three motions mentioned above. This frequency falls in 0.01 Hz to about 0.3 Hz (much less than 1 Hz) band. It differs depending on the vessel, however an average value can be assumed at about 0.1 Hz. Roll angle can be estimated to be between $\pm 15^\circ$. Eddy currents will have components in phase and quadrature with respect to roll. Schematic flow of eddy currents in ship's hull is shown in fig. 1.

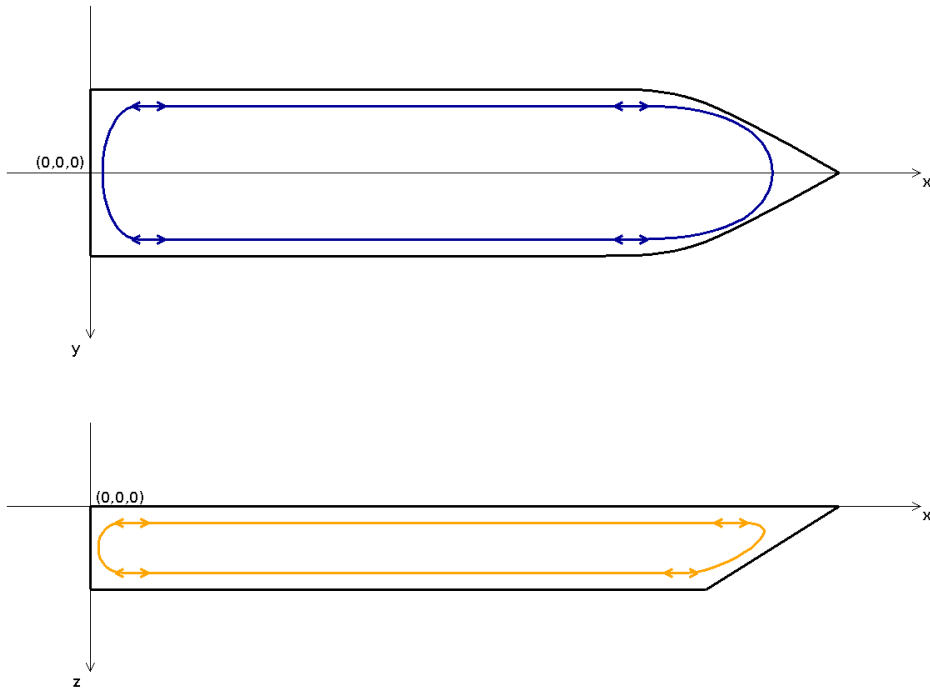

Fig. 1. Eddy currents in ship's hull due to its roll

Distribution of eddy current magnetic field is dipole like (or as from a current carrying coil) and can be modelled as such for chosen frequency and in phase or quadrature component. Simultaneously due to such distribution this field can be minimized using on board degaussing system and its coils. Eddy current magnetic field is present for all conducting hulls, also including low magnetic steels and aluminium ones. Relative magnetic permeability has influence on that field in low frequencies (close to dc). Material's conductivity has an impact on values and frequency of change of dominating component. With increasing conductivity, maximum values are reached at lower frequencies. Important factor is that field's frequency band is below 1 Hz and overlaps with bandwidth of possible detection systems. Example magnitudes of several materials are shown in fig. 2. Plot is done for 15 000 nT external vertical magnetic field, infinite cylinder with 10 m radius (b), and 0.04 m (i.e. internal radius $a = 9.96$ m) wall thickness (materials: aluminium — $\mu_r = 1$, $\sigma = 35 \cdot 10^6$ S/m; high strength steel HSS — $\mu_r = 180$, $\sigma = 5 \cdot 10^6$ S/m; AL6XN/EN 1.3964 steel — $\mu_r = 1.01$, $\sigma = 1 \cdot 10^6$ S/m; carbon fibre — $\mu_r = 1$, $\sigma = 0.1 \cdot 10^6$ S/m). Measurement point is 20 m (d) below centre of the cylinder.

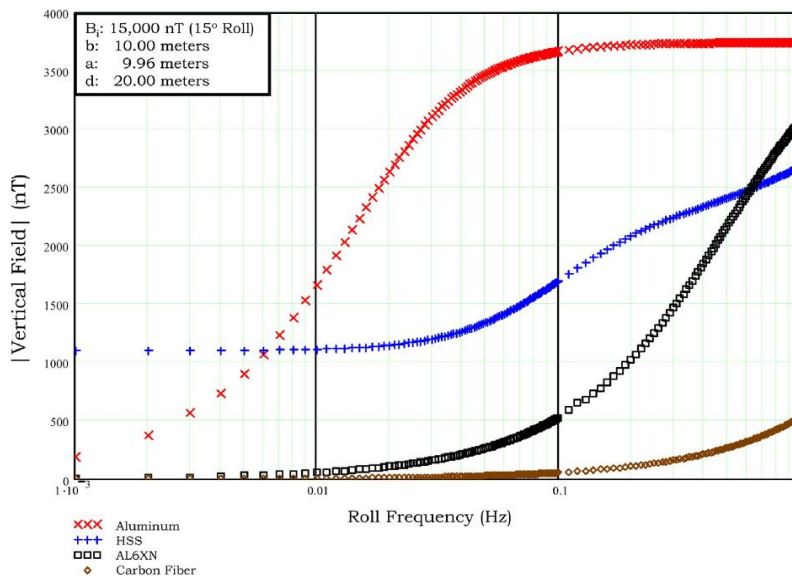

Fig. 2. Eddy current magnetic field magnitude from conducting cylinder made of different materials [13]

Constant magnetic field for magnetic steel at low frequencies can be clearly seen (which is not associated with eddy currents) as well as eddy current component that increases with frequency. Maximum values of eddy current field achieve levels similar to field from magnetization of hull and equipment and can be used by detection system. Level of that field strongly depends on sea state and is reduced in calm sea, which should be kept in mind during ship's magnetic signature minimization process.

Estimation of field values with respect to roll frequency can be done using mathematical models based on ellipsoid of revolution or cylinders with chosen material and wall thickness. Ellipsoid/cylinder is placed in external sinusoidal magnetic field. Another way is to use Finite Element Methods (FEM) to achieve detailed models. Due to resources and time needed for computer simulations for different roll frequencies, results of land simulations could be stored in a table and used as coefficients in equations used for calculation of DG coils' currents. Simulation of real conditions (or close to real) of variable magnetic field around the ship can be performed in special test ranges called Electromagnetic Roll Facilities (such as EFS — Earth Field Simulator in Bunsdorf/Schirnau/Lehmbek in Germany). In such facilities external field is rolled instead of the ship. If it is not possible to perform full scale measurements using real vessel, it seems necessary to do such test in laboratory using physical scale models. Model placed in external varying magnetic field with uniformity volume larger than the model, will be source of eddy current magnetic field. Using scale laws and appropriately fast and precise measurement

system it is possible to measure that secondary field and isolate its in phase and quadrature components.

Control of eddy current magnetic field in sea during voyage can be performed by precise geomagnetic model and magnetometers working with high frequency ($f \approx 10 - 100$ Hz) to represent field in frequency and time domains with high resolution. On board ship frequency and amplitude of roll and pitch movements are measured by navigation system and magnetic field in ship's reference frame is directly measured by magnetic field sensors. All should be synchronized to find phase reference and filtered to return only data due to movement of the hull (e.g. not higher frequency local oscillation). Measurement and buffering roll, pitch and field data can be used to predict next external field values and calculate currents in coils to be in phase with secondary magnetic field. Currents are then summed with other DG components and fed into DG coils.

Weakly conducting environment such as seawater has minimal influence on magnetic field decay at these frequencies. However influence of conducting hull can be significant and has to be estimated using analytical and FE models.

Earth's Field Simulator — WTD 71, Germany [14]

Example of facility capable of simulation and measurement of eddy current magnetic field is Earth Field Simulator in Bunsdorf/Schirnau/Lehmbek in Germany (fig. 3). It is part of WTD 71. Coil system consists of three coil sets — allowing generation of magnetic field in three directions. Measurement system comprises sensors on two depths — 9 m and 13 m below surface. Apart from all measurements connected with permanent, induced magnetisation isolation and data for calculation of off board loop effect, facility allows generation of slowly varying magnetic field and its measurements (including secondary field from eddy currents in hull). Measurements are taken for an empty simulator and replaced for simulator with ship inside. Both are done for the same field parameters.



Fig. 3. EFS in Kiel Canal [14]

Part of RIMPASSE trials took place in EFS including eddy current magnetic field measurements of CFAV Quest (fig. 4).



Fig. 4. CFAV Quest inside EFS (left) [1] and schematic drawing of EFS with ship inside (right) [2]

CALCULATIONS AND SIMULATIONS

Measurements of a real ship can be carried out in two ways: by physically rolling and pitching a ship in external field or by varying field around a fixed ship. In the first case additional mechanical installation that allows such movements is required. Special data acquisition and processing system is also needed that eliminates magnetic field due to changes in relative position between ship and sensors (one side is closer, other is further from the ship) and isolation of magnetization component. In the second case external coil system is necessary that generates uniform field in large enough volume to include a whole ship. Ship can be driven into the installation (so called 'drive in' facility, as EFS) or towed over it (with coils on the bottom, such as in modernized Kiel-Friedrichsort range). Slowly varying magnetic field is generated around stationary ship. Using that method it is easier to isolate magnetization component with minimal error resulting from constant source-sensors distances (in real conditions such distance variation is present).

Only few of the ranges are capable of doing such experiments (e.g. San Diego, Kings Bay, Kitsap Bangor, Pearl Harbour in USA and EFS in Germany) while most are overrun ranges without possibility to generate magnetic field.

Eddy current magnetic signature can also be estimated by calculations and simulations, although with some limitations. Following analytical model presented in [11] and [6] it is possible to use simplified geometry for that purpose. Long thin walled cylinder is a representation of ship's hull without inner walls and seen from

front or back. External varying magnetic field can be applied with arbitrary parameters (frequency, amplitude). Due to long cylinder approximation, model does not diversify measurements near bow or stern and also do not include superstructure influence. However comparison between analytic and FEM model yields the same results. Input parameters also include material data such as: conductivity, permeability. Results should be treated as an approximation allowing estimation of secondary's field order of magnitude.

FEM simulations allow calculation of field from any geometry with any material parameters. Also external field can be much more precisely defined (apart from frequency and amplitude, e.g. directions and measurement points, planes can be freely chosen). Some limitations are geometry detail and accuracy of material specification. Model should be built according to major FEM rules (e.g. less detailed than real, without elements that have negligible impact on results; limited aspect ratio of objects; with flat surfaces rather than curved ones). It is usually very difficult to precisely specify material parameters (due to necessity to take many measurements on board and to have meters with sufficient full scale range) and also not required. Mapping inhomogeneities on model would result in too many material definitions and objects that will have limited impact on results. Instead parameter validation with trial and error method that matches parameters to actual results in controlled conditions can be used. Example of such method is shown in CFAV Quest EFS measurements [2].

In calculations and simulations apart from secondary field it is necessary to find off board loop effects. Loop effects are different for variable field that for constant responsible for cancelling fields due to magnetization. It results in another parameter in DG algorithm that couples coils' currents with roll/pitch frequency.

In order to estimate level of eddy current magnetic field due to different input parameters, model based on [11] and [6] was programmed and verified with results presented by authors, FEM simulations and measurements. Analytical model employs infinite hollow cylinder that represents simplified ship's hull. External sinusoidal magnetic field is applied which simulates roll of the cylinder. Model is useful for showing parameter impact such as wall thickness, conductivity and permeability and frequency dependence. Model geometry is shown in fig. 5 which is simplified representation of a ship shown in fig. 6. Eddy currents in model are effect of variable external magnetic field.

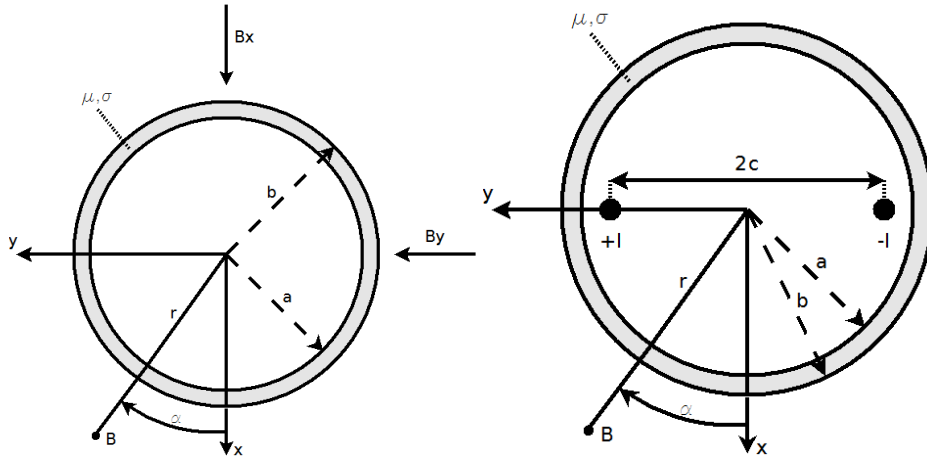

Fig. 5. Analytical model geometry: ship's hull (left); hull with loop (right)

Model allows definition of: external field amplitude (B_x), inner and outer radii of hull (a and b), material's conductivity and permeability (μ_r and σ), measurement point B is at distance (r) and angle (α), roll frequency (fig. 5). Derived equations correspond to ship rolling in geomagnetic field as shown in fig. 6. Maximum eddy currents are induced in hull of ship rolling on E-W course, when north component of magnetic field is perpendicular to its long axis.

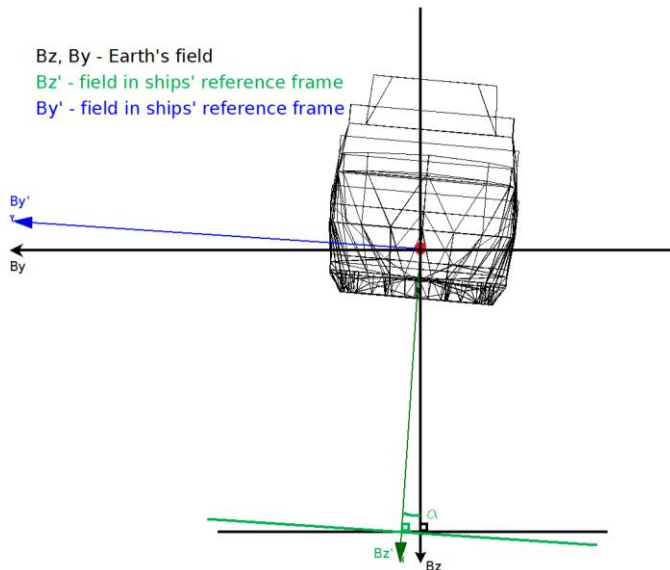

Fig. 6. Ship shown from stern on E-W course

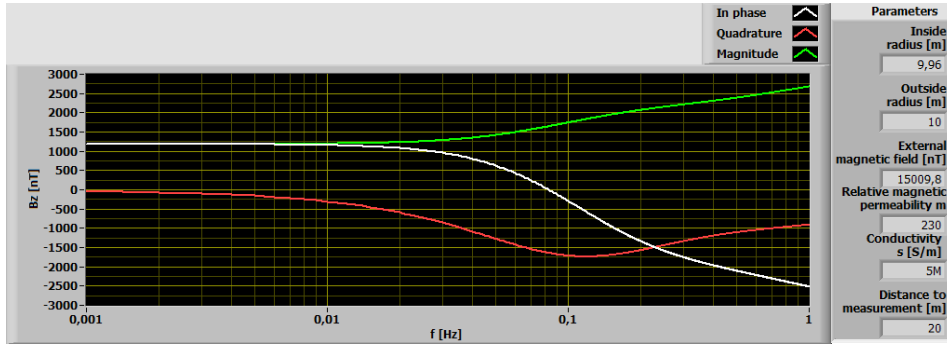

Fig. 7. Model results for $\mu_r = 230, \sigma = 5 \text{ MS/m}$, HSS steel

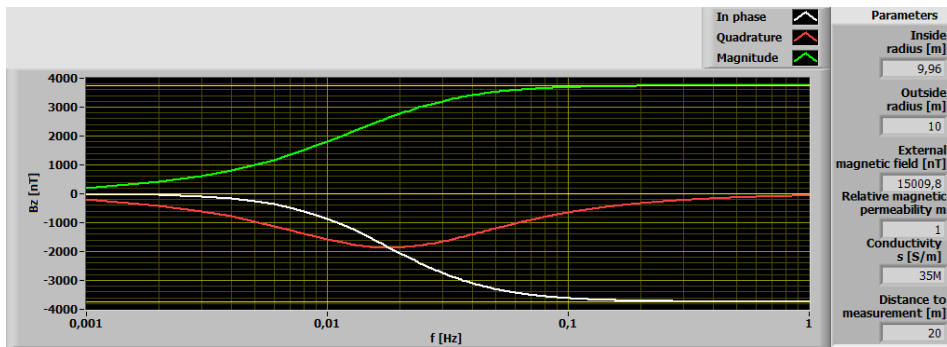

Fig. 8. Model results for $\mu_r = 1, \sigma = 35 \text{ MS/m}$, aluminium

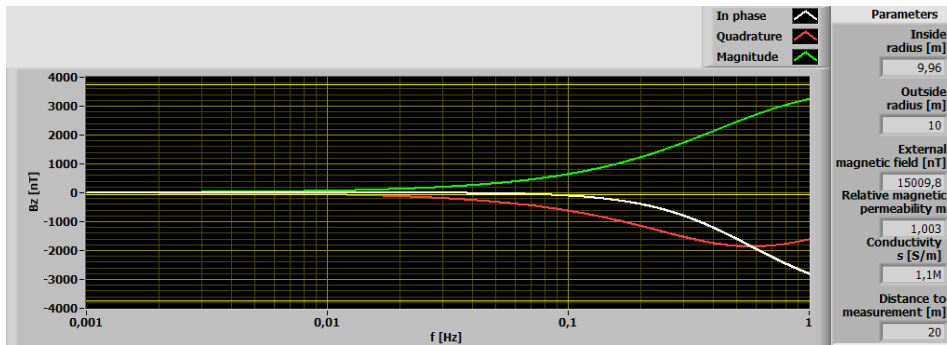

Fig. 9. Model results for $\mu_r = 1.003, \sigma = 1.1 \text{ MS/m}$, AL6XN steel

Fig. 7–9 (for the same parameters as for fig. 2) show amplitudes of secondary field: in phase — white, quadrature — red and magnitude — green, for chosen materials calculated using analytical model.

In the first step of FEM analysis similar models were prepared to verify analytical ones. Next several other geometries, not possible to calculate analytically, were built. Two hollow cylinders similar to ones from [11] and [13] were simulated. Varying magnetic field of uniform amplitude in whole volume was applied with frequencies up to 2 Hz. Appropriate mesh operations were applied. Results similar to analytical model (within 20%) were obtained.

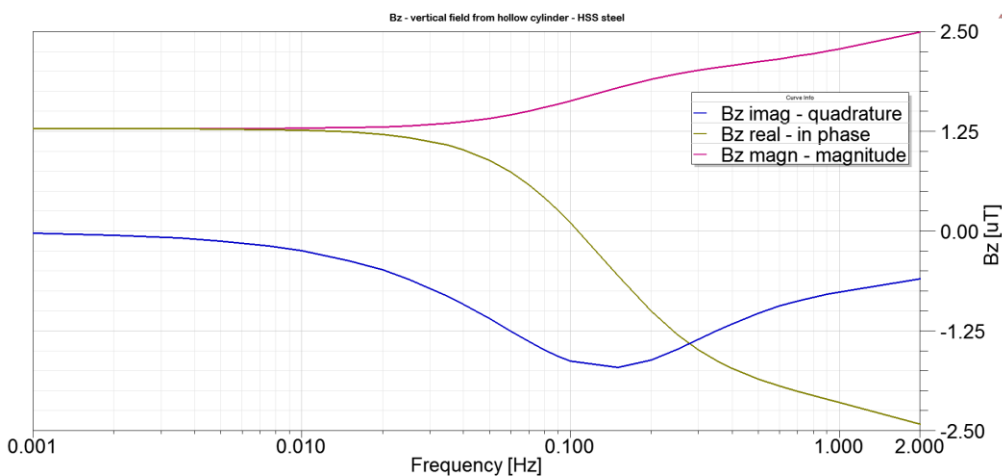

Fig. 10. FEA results for $\mu_r = 230$, $\sigma = 3.5$ MS/m, HSS steel

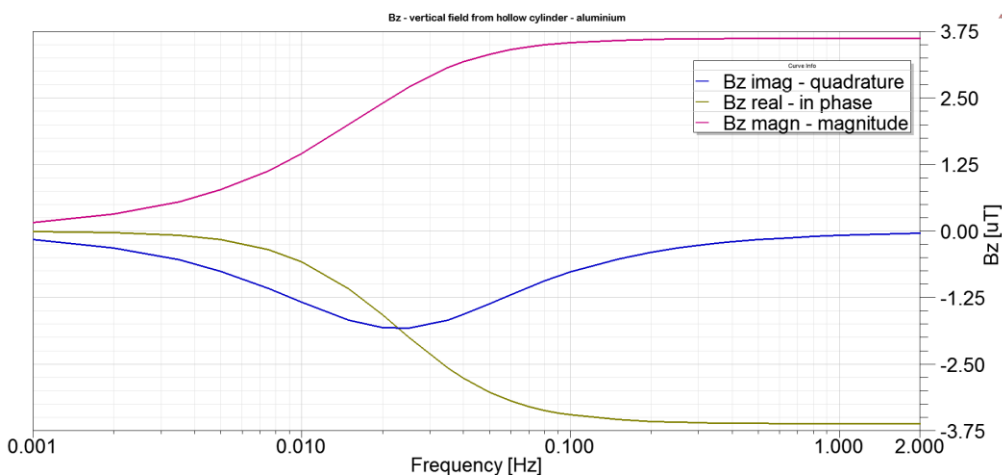

Fig. 11. FEA results for $\mu_r = 1$, $\sigma = 35$ MS/m, aluminium

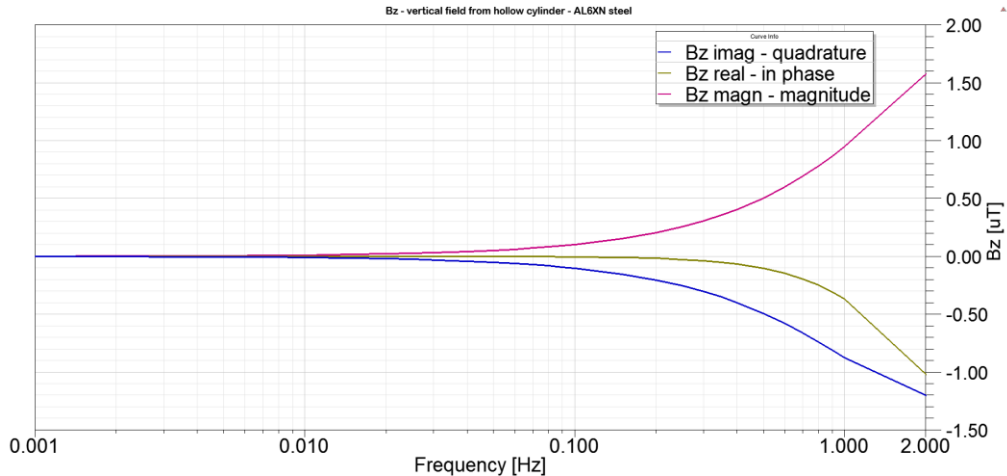

Fig. 12. FEA results for $\mu_r = 1.003$, $\sigma = 1.1$ MS/m, AL6XN steel

Fig. 10–12 show amplitudes of secondary field: in phase — olive, quadrature — blue and magnitude — violet, for chosen materials estimated using FE models. In the second step, detailed model of ‘Kormoran’ II MH in 1:1 scale and model of physical scale model with degaussing coils were prepared. Screening effect of conducting hull on off board loop effect for magnetization field cancelling is negligible due to slow changes of currents in coils. However in order to minimize eddy current magnetic field currents need to vary much faster (up to fraction of Hz). Despite working below 1 Hz, hull effect has to be investigated, to be able to neglect or include another parameter in DG.

Another analytical model was programmed to verify that [11] (fig. 13). Comparison and verification was done in Maxwell FEM analysis (fig. 14). Simplified starting model consists of infinite hollow cylinder enclosing M coil modelled by two wires close to the hull walls. In FEM cylinder is of limited length and loop is closed. FEM results are shown for the same point as those from analytical model.

Analytical model geometry is shown in fig. 5. Current carrying wires are put at $2c$ distance and carry $+I$ and $-I$ current (90 Ampere-turns). Following [8] radial and tangent field components were calculated in (r, α) point.

According to results from analytical and FEM models it is necessary to include coefficients in DG calculations responsible for hull screening. Those coefficients should be calculated for all possible frequency ranges.

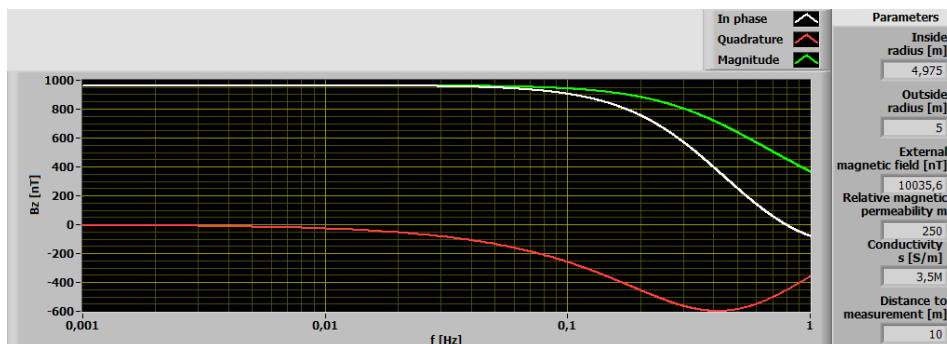

Fig. 13. Off board loop effect for coils inside conducting hull — analytical model

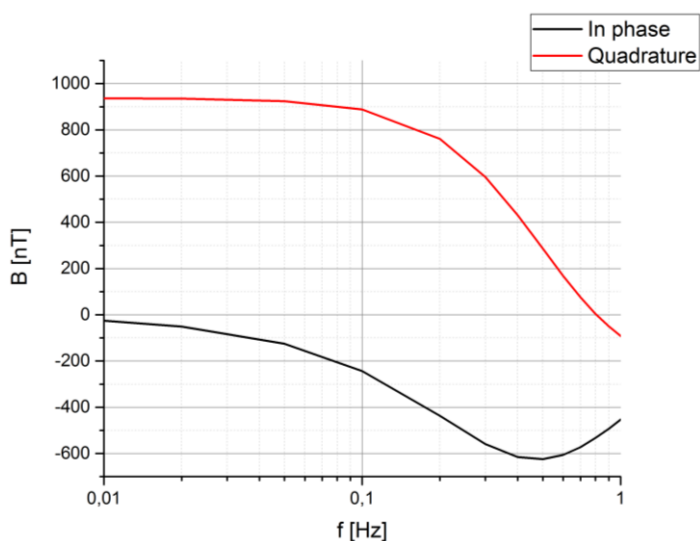

Fig. 14. Off board loop effect for coils inside conducting hull — FE model (in phase — red, quadrature — black)

Subsequently FEM simulations of ship model and its physical scale model were performed. Simulation results are presented with following parameters: frequency range $f = 0.05 - 1$ Hz, field amplitude $B_z = 10 \mu T$. Field amplitude corresponds to roll angle of 11.5° . According to analysis shown in [7], simulations of stationary ship model in varying field instead of moving the model in fixed field introduces small and negligible error (less than 10%). That simplification results in much shorter analysis times. Field components for chosen frequencies are shown in figures (with bow at 58 m and stern at 0 m). Ship model with measurement plane is shown in fig. 15. Same picture also shows schematically vertical field case.

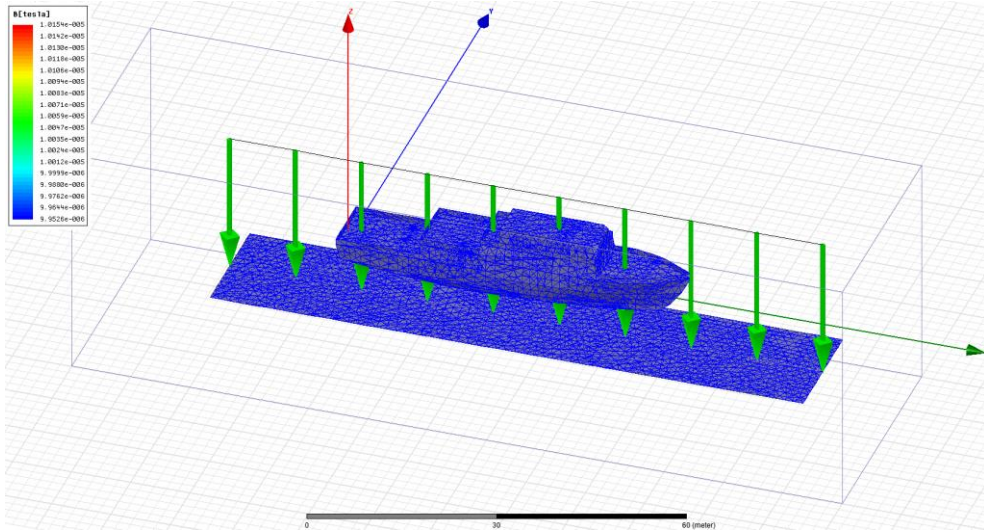

Fig. 15. Ship's model in vertical external field

Fig. 16 and 17 show longitudinal and vertical components of secondary field for $f = 0.1$ Hz — frequency of external magnetic field change. Top plot shows quadrature component and bottom in phase component. Top and bottom scales are the same to show amplitude difference.

Amplitude increase with frequency is clearly seen in fig. 18, which presents dependence of quadrature vertical component on frequency.

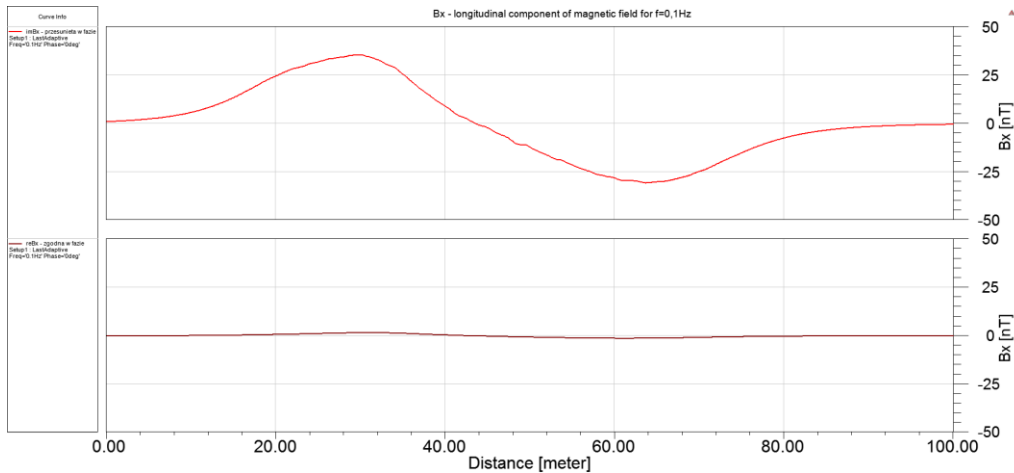

Fig. 16. Longitudinal component: quadrature (top) and in phase (bottom) for $f = 0.1$ Hz

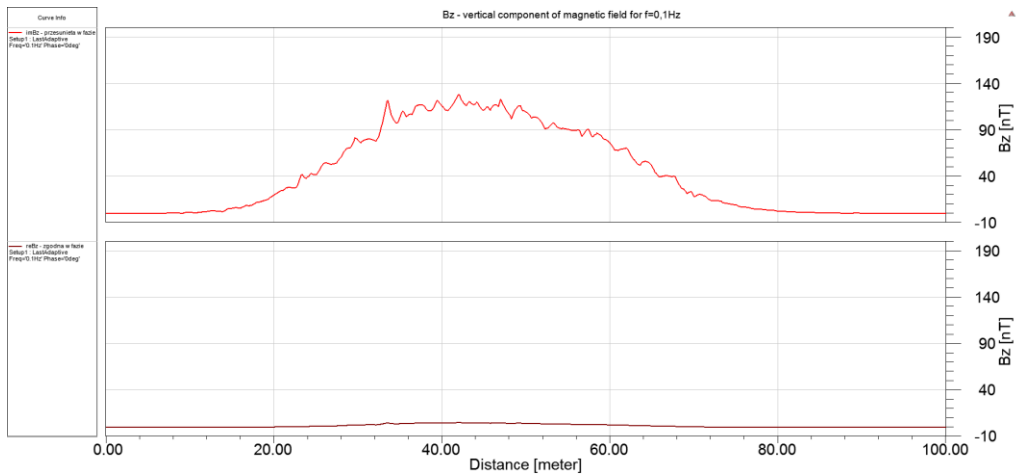

Fig. 17. Vertical component: quadrature (top) and in phase (bottom) for $f = 0.1$ Hz

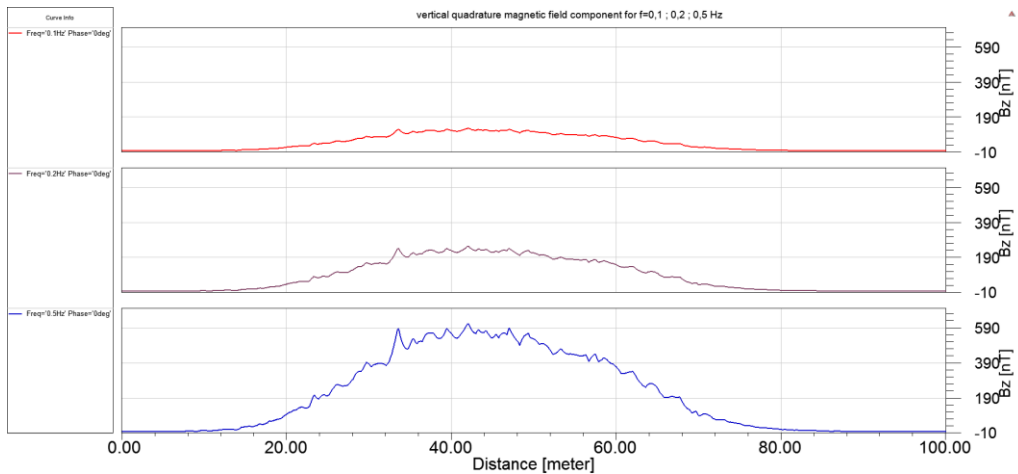

Fig. 18. Quadrature vertical component for $f = 0.1$ Hz (top), 0.2 Hz (middle) and 0.5 Hz (bottom)

Current densities in hull were also calculated. Plots showing amplitudes and directions of in phase and quadrature components are presented in fig. 19.

Eddy current density and field produced by them are most probably over-estimated comparing to real ship. The main reason is modelling of continuous hull structure without increases in resistivity on welds. Due to them current amplitude is reduced and current flows in smaller loops enclosed by higher resistivity boundaries formed by welds.

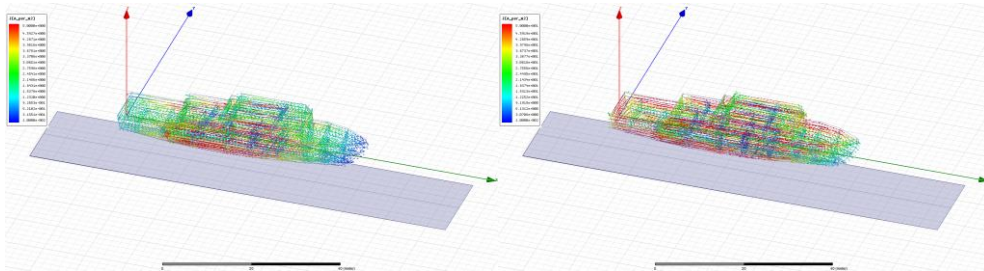

Fig. 19. In phase current density ($j_{maks} = 5 \text{ A/m}^2$) (left), quadrature current density for $f = 0.2 \text{ Hz}$ ($j_{maks} = 50 \text{ A/m}^2$) (right)

Simulation in frequency domain allows estimation and plotting of both secondary fields' components and calculation of phase shift in field measured by magnetic field sensors under models after careful data processing and analysis.

Simulations in time domain on the other hand allows calculation of phase shift based on direct current-field measurements. Phase shift originates from quadrature component. Knowing external field amplitude and phase shift it is possible to estimate secondary field amplitude.

MEASUREMENTS

Special test stand was designed and built for the measurements of eddy current magnetic field from simplified and detailed scale models. Coil arrangement is able to generate vertical and transverse magnetic field — two main causes of secondary field for ship rolling in geomagnetic field. Coils' dimensions allow for putting inside object about 5 m long in uniform field. Power supply is capable of outputting synchronised sinusoidal current of chosen frequency and amplitude for both components. Measurements are taken with low noise fluxgate sensors sampled by fast, high resolution data acquisition system.

Coil arrangement is 4 m x 4 m x 8 m large with Z and Y coil pairs. Long side is parallel to N direction. Schematic drawing of coils is shown in fig. 20.

Measurements were performed using two to six fluxgate magnetometers placed under both models.

Test stand was simulated in Ansys Maxwell and CTM's proprietary software. Field outputs for 1 ampere-turn are shown in fig. 21 and 22.

Simulation results show sufficiently large uniformity volume to perform measurements on objects up to 5, 6 m long which is adequate for prepared scale models.

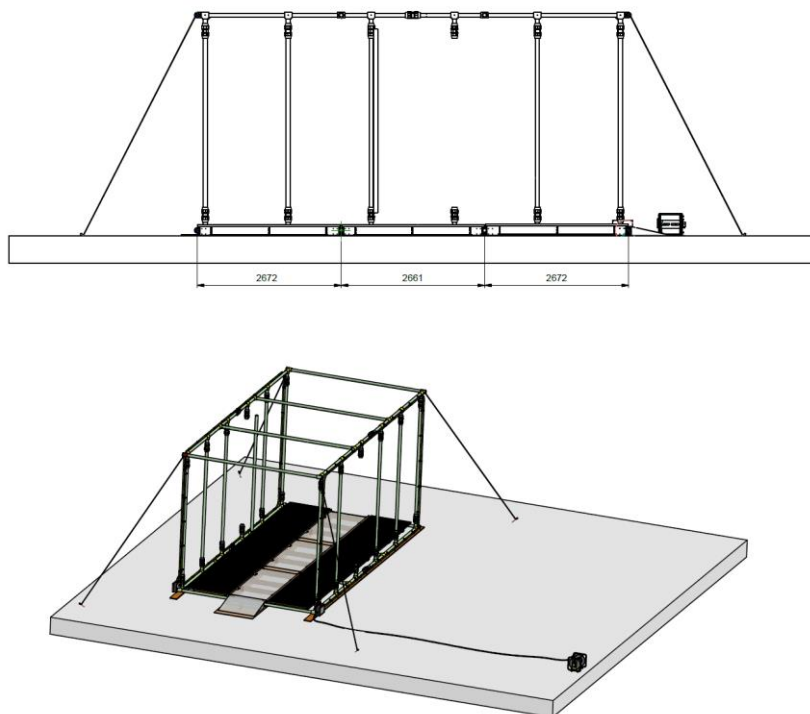

Fig. 20. Schematic drawing of test stand

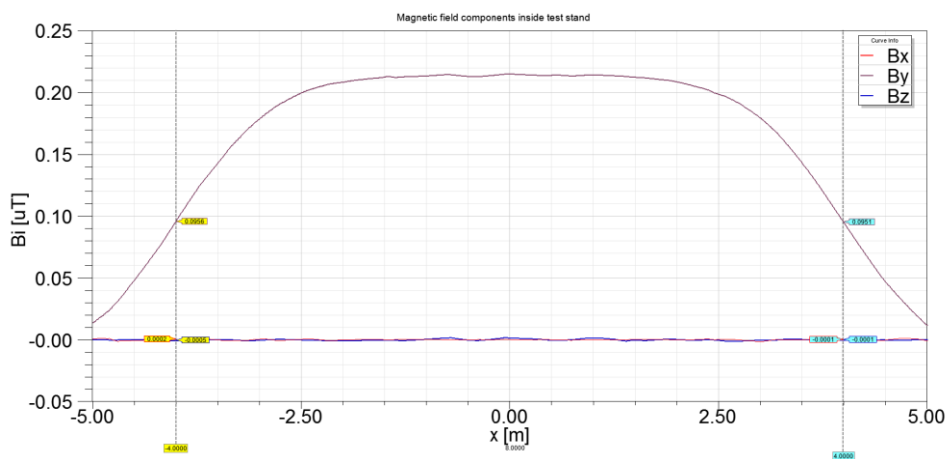

Fig. 21. B_y component generated by test stand

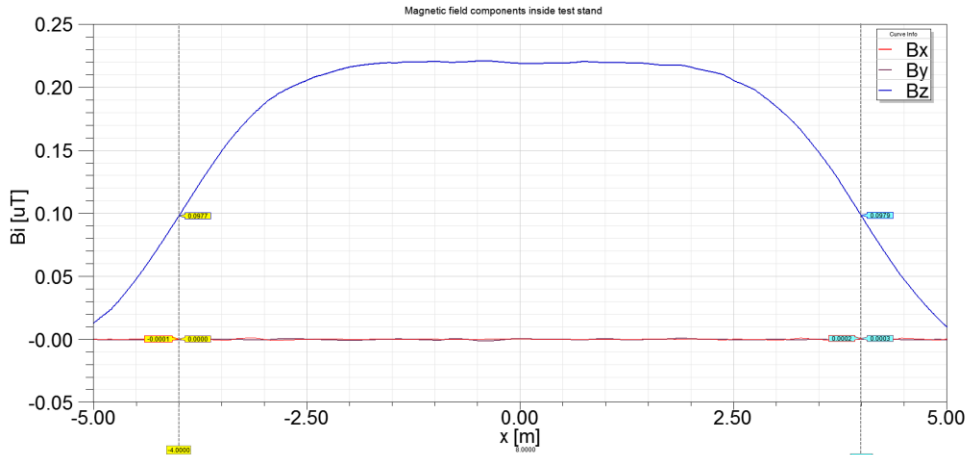

Fig. 22. B_z component generated by test stand

Comparison of measurements with calculations was done using non-ferromagnetic, conducting, steel cylinder and PSM shown in fig. 23 and with parameters in tab. 1. Object was put inside test stand as shown in fig. 24 and schematic drawings of test stand are shown in fig. 25 and 26.



Fig. 23. Models used during measurements



Fig. 24. Models inside test stand

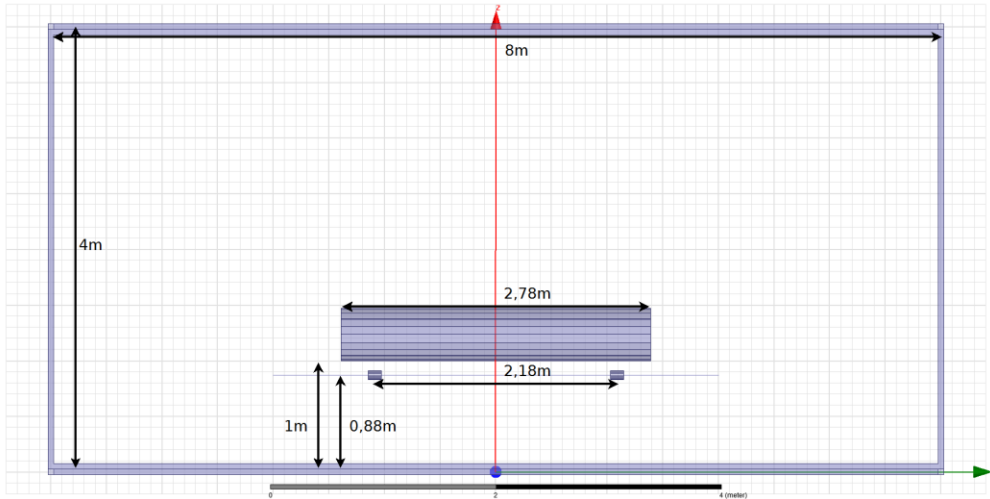

Fig. 25. Schematic drawing of simplified model in test stand

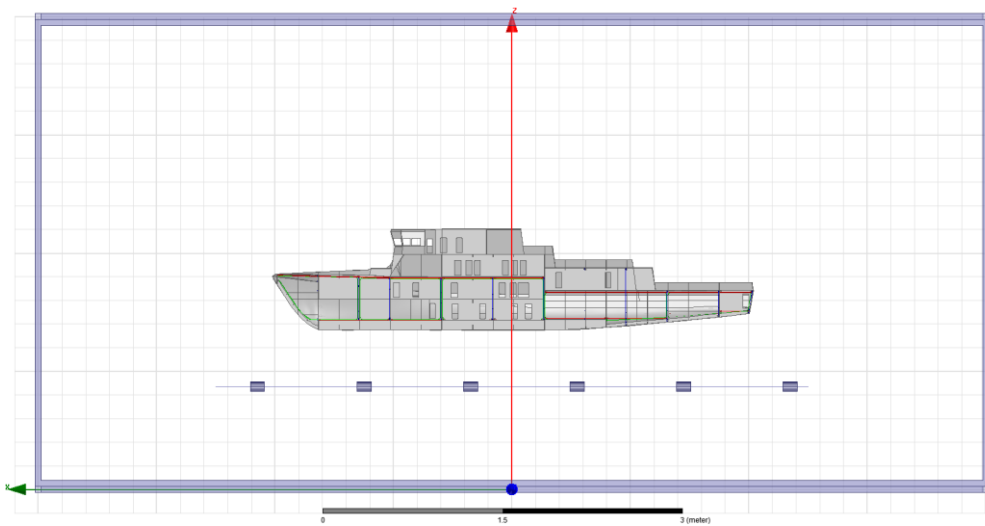

Fig. 26. Schematic drawing of simplified model in test stand

During measurements it was decided to use simplified model at the first stage due to possibility of easy comparison between calculations and measurements and easier handling. Detailed model gives more precise data and allows estimation of secondary fields from real ship, however validation of models and repeated putting in and out from the test stand is much easier with lighter model.

Tab. 1. Cylinder dimensions and material parameters

Name	Length [m]	Diameter [m] Height/width [m]	Wall thickness [m]	Conductivity [MS/m]	Material
SIMPLIFIED MODEL	2.78	0.47	0.0015	0.9	Stainless steel
PSM (with full DG)	4	0.85/0.7	0.001–0.0015	1.45	Stainless steel

Measurements were taken for frequencies from 0.1 to 40 Hz with the same external field amplitude. Such high frequency limit is due to scaling rules. All measurements were repeated several times and models were removed and put again into the test stand. Object manipulation didn't have influence on results.

RESULTS

Achieved results of voltage, current and field in time domain were analysed to find dependence of phase shifts between values without and with object in the test stand. Special programmes were prepared to control field generation and to analyse data.

Amplitudes, frequencies and phase shifts between signals are calculated with one and put into the table. Another one allows generation of reference sine signals with variable frequency, amplitude and phase and adding them to match results obtained from measurements to find resulting amplitude and phase. This is done because it is not possible to directly measure secondary field in chosen method. Sample screen is shown in fig. 27.

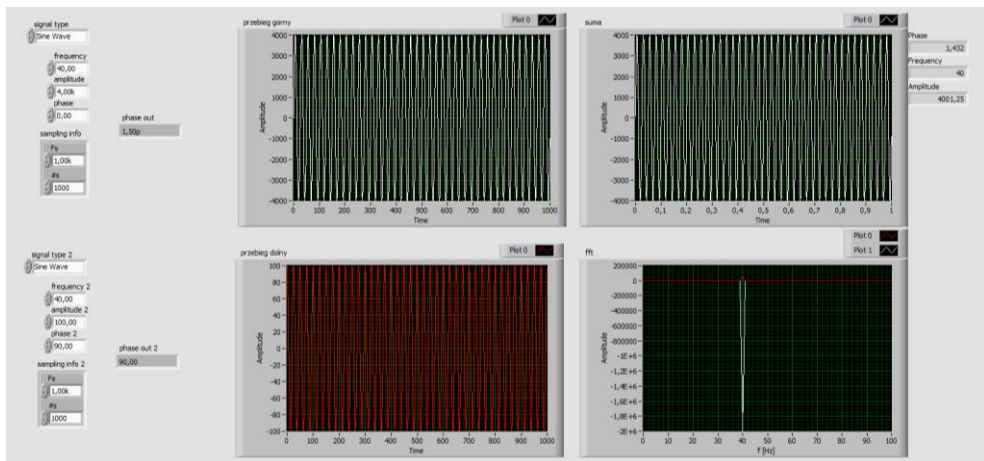

Fig. 27. Sample screen from sine summation programme

Together with results from analytical model, programmes allow validation of observed phase shift and attributing it to eddy currents induced in model and especially to quadrature component. Fig. 28 shows parameters of analytical model and results that correspond to the measurements.

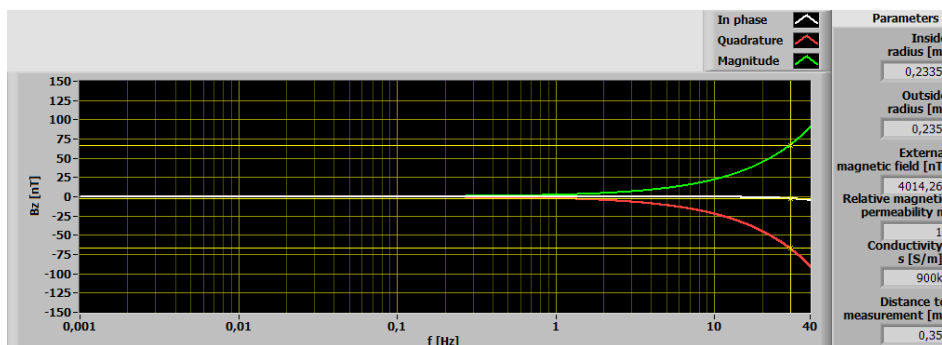

Fig. 28. Analytical model results for simplified model case

For PSM measurements were taken for frequencies from 0.1 to 40 Hz (scaling) with the same external field amplitude at each frequency. Voltage, current and field in time domain were analysed to find dependence of phase shifts between values without and with object in the test stand. Amplitude estimation is done by finding quadrature field causing measured phase shift, because it is not possible to directly measure secondary field in chosen method. Results for PSM secondary fields and screening effect are shown in fig. 29.

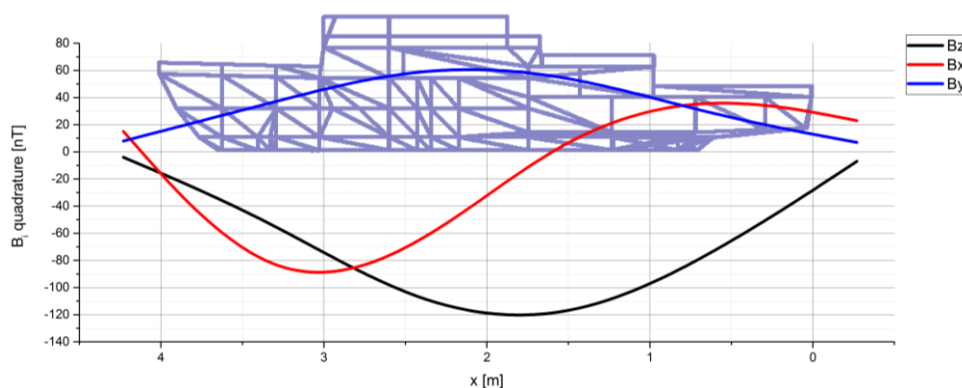

Fig. 29. Example secondary fields @ 40 Hz (middle) and hull screening effect for one of the coils (bottom) — which for the PSM is negligible (in accordance with calculations)

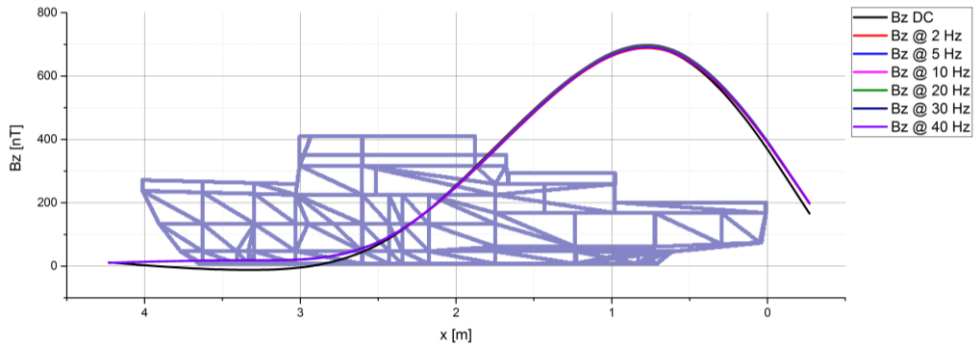

Fig. 29 cont.

Several possible error sources were identified and checked:

- sampling frequency (simultaneous 2 kS/s/ch) that could introduce time shifts was checked against results at 10 kS/s/ch;
- intrinsic data acquisition system delay;
- time shift between different channels, voltage, current and field measurements.

All above sources were verified as having no impact on measurements.

PASSIVE AND ACTIVE MINIMIZATION OF EDDY CURRENT MAGNETIC SIGNATURES

Passive reduction of ship's eddy current magnetic field signature is done by appropriate selection of materials on its design and construction phases [3–5, 13]. Amplitude at low frequencies increases with conductivity up to a maximum value (which is also to a lesser degree dependent on magnetic permeability). According to results for different materials (HSS, aluminium and austenitic steel) the best material is austenitic steel (low conductivity and relative magnetic permeability close to 1).

Active reduction can be done by DG coils. To do so, power supplies have to be able to generate additional time varying current components in phase and quadrature, and then add it to currents minimizing field from magnetization. Off board loop effects have to be measured and saved as coefficients with respect to roll frequency. Coefficients can be calculated for several points and interpolated for other between to cover whole roll frequency band.

Block diagram of DG system with eddy current magnetic field minimization blocks included is shown in fig. 30. Such DG needs information about external magnetic field and its variation (standard mast magnetic field sensor, roll, pitch, yaw, position and course for calculation from geomagnetic field model). DG should work with 10 Hz frequency or faster.

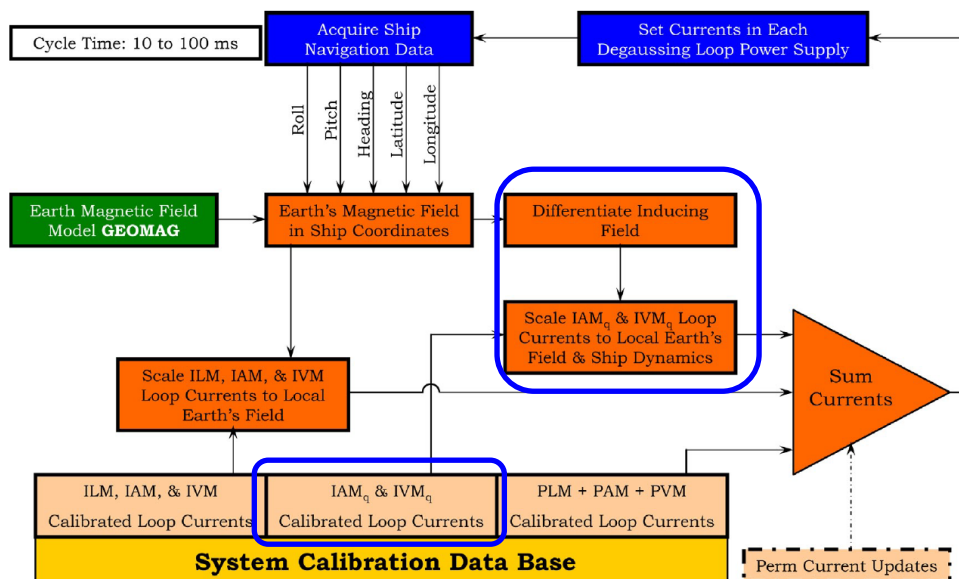

Fig. 30. DG with eddy current magnetic signature reduction module [13]

Estimated levels of eddy current magnetic field, especially for vessels with very strict requirements, such as mine sweepers and mine hunters, lead to necessity to work on its minimization modules integration into current DGs, apart from main development trends i.e. on closed loop DG.

Theoretical works, calculations, simulations, measurement campaigns [2, 7, 9, 11] and data presented in their reports suggest necessity to include such module into DG. On the other hand evolution of FE software and capabilities provides significant support in those works.

Integration of minimization module with actual DGs

Adding capability to minimize eddy current field requires increasing DG work frequency from about 1 Hz to 10 Hz and more. That way information about actual ship's position and orientation is accurate and measured without too much aliasing (roll and pitch angles, external field). Increased work frequency is needed

to quickly calculate and generate appropriate currents' values, close to real time, to be in phase with actual field (e.g. so DG's output does not lag behind actual field). Possibility to independently set current in each coil and programmatically add them to current responsible for minimization of magnetization field, greatly simplifies control over DG. Current set for each coil is already a sum of all components. Indispensable elements of such module are quick roll-pitch-yaw and field sensors. Using stored data and prediction algorithms it is possible to set current in advance and to be on time with field. Together with stored coefficients for all coils, module can work on data from magnetic field sensor on mast or calculate field in ship's reference frame basing on models.

Period values between 10 ms and 100 ms depend on the slowest element in system and includes apart from sensors also software and power supplies. The latter ones should in one cycle receive, set, measure and send back actual values and most probably they will limit speed of the DG.

Required measurements for the ship

Calculation of coefficients and parameters of DG system designed for eddy current magnetic field minimization requires performing measurements on special range such as EFS in WTD71 or another ERF (Electromagnetic Roll Facility). Alternatively measurements can be taken on ranges such as currently modernized Kiel-Friedrichshort, where overrun range is capable of taking stationary measurements and of generating magnetic field by coils put in the bottom.

Firstly background database should be built from measurements taken for all possible frequencies and amplitudes of external magnetic field without ship present. Fields, currents and voltages should be recorded in time domain, allowing calculation of their time dependencies. Next measurements are repeated for the same parameters, this time with ship present. Background measurements are used to eliminate external magnetic field and to set phase reference to find in phase and quadrature secondary field components. Field parameters choice should cover maximum predicted roll and pitch values for the ship. Additional measurements should be performed to find off board loop effects. Those should be done for each coil at chosen frequency to prepare continuous coefficients functions for whole frequency band.

All measurements should be compared with simulations and appropriate FE models should be constructed before and adjusted based on results to match them. They should allow replacing ship measurements with simulation in the future (of course with some error).

CONCLUSIONS

Number of publications concerning eddy current magnetic field is limited. In most works that field is put on second most important field after field resulting from permanent and induced magnetization of hull and equipment on board. Available literature, apart from theoretical considerations and models, describes one full scale experiment on real ship together with comparison with models. That experiment shows that magnetic field amplitudes can achieve significant values, comparable with field from magnetization (CFAV Quest has ferromagnetic hull) for large roll angles and frequencies (of the order of 15° and $\sim \frac{1}{5}$ Hz).

Correspondence with RIMPASSE trials participant and measurements lead to conclusions that field values for cylinders as well as for uniform models and estimates based upon them are overestimated. On the other hand model itself is correct and verified by FE analysis and measurements. Differences are caused by simplifications (uniform conductivity, no welds and simplified geometry). FE simulation results agree to the order of magnitude with those presented in [2] for similar field parameters. From talks with experts from research institutes dealing with ship's physical field it is also clear that even if eddy current magnetic field is small for vessels without DG, it becomes significant for those with DG and strict field requirements, such as mine hunters or mine sweepers.

Within CTM's project on eddy current magnetic field, measurements of chosen objects in varying magnetic field were performed. Objects included simplified and detailed physical scale models. All assumptions set before measurements were positively verified, except for direct measurement of secondary field — which are too small with respect to external field.

Basing on achieved results analytical and FEM models were validated. Simultaneously effects seen in those models are very small and require precise measurements. Direct amplitude measurements are not practically feasible and only together with simulations and models can lead to isolation of small changes. Obtained results allow scaling of mathematical and FEM models and continuing more thorough investigations with detailed physical scale models.

Expected results of full scale objects — real ships, basing on computer models allow careful estimation of secondary field (however f^2 scale factor has to be verified). It is also evident that although eddy current magnetic field importance is underlined in many publications concerning magnetic signature (especially for mine sweepers and mine hunters), works in DG field are rather concentrated on closed

loop DGs (with strong economic motivation — ship with CLDG can adjust settings away from fixed ranges). On the other hand published standards [3–5] defining requirements for materials used for equipment on board MCM vessels clearly describe requirements with respect to minimization of eddy currents in them. Those requirements should be kept in mind in order to in turn reduce requirements and load on DG. Standards were used during development of Hunt class MCM vessels [3, 4]. It is also interesting that mentions of eddy current minimization systems can be found for much older Ton class mine sweepers.

REFERENCES

- [1] Althof J., *Center for Elektro-Magnetic Underwater Signatures. EMSS 2012*, Eckernförde 2012.
- [2] Birsan M., Tan R., *The Effect of Roll and Pitch Motion on Ship Magnetic Signature*, 'Journal of Magnetism', 2016, 21(4), pp. 503–508.
- [3] Defence Procurement Agency, UK MoD, *Design Guide and Requirements for Equipment to Achieve a Low Magnetic Signature — Defence Standard 02-617*, Issue 2, 11 May 2001.
- [4] Defence Procurement Agency, UK MoD, *Guide to the Design of Ferro-magnetic Signature Control System and Degaussing — Defence Standard 02-612*, Revision I2, 21 July 2008.
- [5] Department of Defense, *Magnetic Silencing Characteristics. Measurement of (Metric) — MIL-STD-2142A(SH)*, USA, 6 August 1990.
- [6] Fawzi T. H., Burke P. E., McLean B. R., *Eddy Losses and Power Shielding of Cylindrical Shells in Transverse and Axial Magnetic Fields*, 'IEEE Transactions on Magnetism', 1995, 31(3), pp. 1452–1455.
- [7] Frigoli L. G., Tassi A., Pinto O., Restivo L., *Eddy Currents Component Evaluation in the Ship Magnetic Signature with a Numerical Model*, MARELEC 2015, Philadelphia 2015.
- [8] Hasselgren L., Luomi J., *Geometrical Aspects of Magnetic Shielding at Extremely Low Frequencies*, 'IEEE Transactions on Electromagnetic Compatibility', 1995, 37(3), pp. 409–420.
- [9] Hendriks B. R., Daya Z. A., Katow L., Fraedrich D., Talbot F. M. et al., *Q340 Cruise Plan/RIMPASSE 2011 Trial Plan*, DRDC-Atlantic-TN 2011-151, 2011.
- [10] Holmes J. J., *Exploitation of a Ship's Magnetic Field Signatures*, 'Synthesis Lectures on Computational Electromagnetics', 2006, Vol. 1, No. 1.
- [11] Holmes J. J., Glover, Brian A., *Roll Induced Eddy Current Generated Magnetic Field Signatures*, EMSS 2012, Eckernförde 2012.
- [12] Holmes J. J., *Modeling a Ship's Ferromagnetic Signatures*, 'Synthesis Lectures on Computational Electromagnetics', 2007, Vol. 2, No. 1.
- [13] Holmes J. J., *Reduction of a Ship's Magnetic Field Signatures*, 'Synthesis Lectures on Computational Electromagnetics', 2008, Vol. 3, No. 1.
- [14] Kramer T., *'New' Earth Magnetic Field Simulation in Lehmbek. First Magnetic Ranging of Submarine U212A*, EMSS 2012, Eckernförde 2012.

BADANIA POLA MAGNETYCZNEGO OD PRĄDÓW WIROWYCH INDUKOWANYCH W KADŁUBIE OKRĘTU

STRESZCZENIE

Pole magnetyczne od prądów wirowych powstających w kadłubie jest jednym ze źródeł pola magnetycznego okrętu, obok pól od namagnesowania indukowanego i stałego obiektów ferromagnetycznych okrętu i znajdujących się na nim urządzeń związanych z procesami korozji i ochroną przed korozją (CRM) oraz pól rozproszonych. W wyniku przechyłów, przegłębień i zmian kursu okrętu w zewnętrznym polu geomagnetycznym indukowany jest przepływ prądu w przewodzącym kadłubie okrętu. Przepływ prądów wirowych jest źródłem pola magnetycznego w przestrzeni dookoła okrętu. Dominujące jest pole związane z przechyłami, gdyż zależy od częstotliwości zmian pola, która jest największa dla przechyłów. Prądy indukowane mają składową zgodną w fazie z przechyłami oraz przesuniętą o $\pi/2$. Wartości tego pola mogą mieć znaczący wpływ na sumaryczne pole magnetyczne po demagnetyzacji dla trałowców i niszczycieli min. W artykule przedstawiono obliczenia, symulacje oraz wyniki badań na modelach zastępczych oraz modelu fizycznym okrętu o konstrukcji kadłuba i nadbudówki wykonanych ze stali małowymagnej przewodzącej (austenitycznej) przeprowadzone w Centrum Techniki Morskiej (CTM). Oszacowano ilościowy udział pola od prądów wirowych w całkowitym polu magnetycznym okrętu dla bardzo niskich częstotliwości.

Słowa kluczowe:

pole magnetyczne okrętu, prądy wirowe, system demagnetyzacji (OUD/DG), model fizyczny w skali.

Article history

Received: 28.05.2018

Reviewed: 29.09.2018

Revised: 06.12.2018

Accepted: 07.12.2018