



Received 18.08.2020
Reviewed 09.10.2020
Accepted 20.10.2020

Field and modelling study for deficit irrigation strategy on roots volume and water productivity of wheat

Ramadan E. ABDELRAOUF¹⁾ ✉, Mohamed A. EL-SHAWADFY¹⁾,
Osama M. DEWEDAR¹⁾, Mahmoud HOZAYN²⁾

¹⁾ National Research Center, Department of Field Irrigation and Water Relations, 33 EL Bohouth St., Dokki, Giza, 12622, Egypt

²⁾ National Research Center, Field Crops Research Department, Giza, Egypt

For citation: Abdelraouf R.E., El-Shawadfy M.A., Dewedar O.M., Hozayn M. 2021. Field and modelling study for deficit irrigation strategy on roots volume and water productivity of wheat. *Journal of Water and Land Development*. No. 49 (IV–VI) p. 129–138. DOI 10.24425/jwld.2021.137105.

Abstract

In many regions of the world, including Egypt, water shortages threaten food production. An irrigation deficient strategy in dry areas has been widely investigated as a valuable and sustainable approach to production. In this study, the dry matter and grain yield of wheat was decreased by reducing the amount of irrigation water as well as the volume of the root system. As a result of this, there was an increase the soil moisture stress. This negatively affected the absorption of water and nutrients in the root zone of wheat plants, which ultimately had an effect on the dry matter and grain yield of wheat. The values of dry matter and grain yield of wheat increased with the ‘Sakha 94’ variety compared to the ‘Sakha 93’ class. It is possible that this was due to the increase in the genetic characteristic of the root size with the ‘Sakha 94’ variety compared to the ‘Sakha 93’ class, as this increase led to the absorption of water and nutrients from a larger volume of root spread. Despite being able to increase the water productivity of wheat by decreasing the amount of added irrigation water, the two highest grain yield values were achieved when adding 100% and 80% of irrigation requirements (*IR*) needed to irrigate the wheat and no significant differences between the yield values at 100% and 80% of *IR* were found. Therefore, in accordance with this study, the recommended irrigation for wheat is at 80% *IR* which will provide 20% *IR*. When comparing the water productivity of two wheat varieties in study, it becomes clear that ‘Sakha 94’ was superior to ‘Sakha 93’ when adding the same amount of irrigation water, and this resulted in increased wheat productivity for ‘Sakha 94’. The SALTMED results confirmed good accuracy (R^2 : 0.92 to 0.98) in simulating soil moisture, roots volume, water application efficiency, dry matter, and grain yield for two varieties of wheat under deficit irrigation conditions. Whilst using sprinkler irrigation system under sandy soils in Egypt.

Key words: irrigation, roots volume, SALTMED model, soil moisture, water productivity, wheat

INTRODUCTION

Water scarcity is one of the most serious problems facing crop production in arid Egypt. It is important to reduce consumption of water by irrigation through developing innovative, effective technologies [EL-METWALLY *et al.* 2015]. In semi-arid and dry areas with a high population density and freshwater borders, there is significant pressure on the agricultural sector to reduce their limited freshwater consumption for irrigation to other sectors [HOZAYN *et al.*

2016]. Increasing crop water productivity is a major goal as demand continues to grow due to high population growth [ABDELRAOUF *et al.* 2012; BAKRY *et al.* 2012;]. Increasing competition is putting further strains on the already scarce water resources. The application of new irrigation techniques to increase water productivity and improve crop production and quality characteristics is vital [MARWA *et al.* 2017]. The application of modern irrigation methods and associated techniques is a key concept that must be carried out

in arid regions as in Egypt to provide irrigation water [EL-HABBASHA *et al.* 2014].

Wheat (*Triticum aestivum* L.) is one of the main staples crops for global food security, providing about 20% of the total food calories and protein needs, with about 730 mln Mg of annual production which is harvested from about 2.1 mln km² area globally [SHIFERAW *et al.* 2013]. Wheat is one of the major cereal crops in terms of area and production in the world. To overcome future demand for food, wheat yield and its production potential capacity must be increased under limited water conditions due to the increasing threat of drought stress on agricultural land worldwide [DEL POZO *et al.* 2016]. Wheat grain production and its components decreased when exposed to drought stress [FANG *et al.* 2006]. Efficiency and productivity of water are indicators which are used in many scientific disciplines, and usually calculated by water losses that occur during the use or by the products which resulted per unit of water consumed [KAMBOU *et al.* 2014]. Deficit irrigation is a method for maximizing water use efficiency (WUE) for the highest yield per applied unit of irrigation water. Excessive irrigation may result in reduced WUE of the yield and the effective deficit irrigation might lead to higher production and WUE [JIN *et al.* 1999]. The selection of suitable varieties in cereal crops has long been an essential component of agricultural success [LUO *et al.* 2018]. Plants differ including wheat varieties in their tolerance to intrinsic drought, which is expressed through continuous adjustments between availability, water requirements and their specific ability to improve the state of water [CHENCHOUNI, 2017; MIHOUB, MOKHTARI 2016].

The aim of this research is to study the effect of deficit irrigation water and wheat varieties on productivity and water use of wheat, and the results should supply some recommendations to farmers in arid and semi-arid regions to choose the appropriate variety under effective irrigation water rate, improving yields as well as water productivity.

MATERIALS AND METHODS

Location of experimental site. Field experiments were conducted at the research farm of the National Research Centre (latitude 30°30'1.4" N, longitude 30°19'10.9" E, and 21 m MSL (mean sea level) Nubaryia Region, Egypt. The data of maximum and minimum temperature, relative humidity and wind speed were obtained from the local weather station at the farm.

Properties of soil and irrigation water. The main physical and chemical properties of soil were determined in situ and in the laboratory Table 1. The main physical and chemical properties of irrigation water are reported in Table 2.

Experimental design. The experimental design included two wheat varieties: 'Sakha 94' and 'Sakha 93' and four deficit irrigation strategies (100% *IR*, 80% *IR*, 60% *IR* and 40% *IR*). The two factors were arranged in a strip design Figure 1.

Irrigation scheduling for wheat. Total water irrigation (m³·ha⁻¹ per season) was estimated according to the meteo-

Table 1. Physical and chemical characteristics of the soil

Soil characteristics	Soil layer (cm)		
	0–15	15–30	30–45
Physical parameters			
Texture	sandy	sandy	sandy
Coarse sand (%)	47.86	56.62	36.65
Fine sand (%)	49.67	39.64	59.50
Silt + clay (%)	2.47	3.74	3.85
Bulk density (Mg m ⁻³)	1.68	1.69	1.69
Chemical parameters			
EC (dS m ⁻¹)	0.41	0.42	0.44
pH	8.80	8.70	9.00
Total CaCO ₃ (%)	7.12	2.36	4.62
Organic matter (%)	0.61	0.43	0.30

Explanations: EC = electrical conductivity.

Source: own elaboration.

Table 2. Characteristics of irrigation water

Parameter	Irrigation water
EC (dS m ⁻¹)	0.40
pH	7.37
Calcium, Ca ²⁺	1.04
Magnesium, Mg ²⁺	0.52
Sodium, Na ⁺	2.42
Potassium, K ⁺	0.22
Carbonate, CO ₃ ²⁻	<0.01
Bicarbonate, HCO ₃ ⁻	0.11
Chloride, Cl ⁻	2.73
Sulphate, SO ₄ ²⁻	1.34
Nitrogen, N (NH ₄ ⁺ +NO ₃ ⁻)	<0.01

Explanations: EC = electrical conductivity.

Source: own elaboration.

Table 3. Seasonal water irrigation of wheat for deficit irrigation treatments (m³ ha⁻¹ per season)

Period	100% <i>IR</i>	80% <i>IR</i>	60% <i>IR</i>	40% <i>IR</i>
2015/2016	5 040	4 032	3 024	2 016
2016/2017	4 800	3 840	2 880	1 920

Explanations: *IR* = irrigation requirements.

Source: own elaboration.

rological data depending on Penman–Monteith and using sprinkler irrigation as shown as in Table 3.

Soil moisture content (SMC): observed SMC was determined by profile probe.

Roots' volume of wheat plant (RV_{wheat}). The observed RV_{wheat} was chosen due to the fact that most plant roots, including wheat, have many shapes within the soil section. To determine the size of wheat roots within the soil sector, the radius of the horizontal roots was measured. In addition to measuring the effective vertical length of roots, the effective root size within the soil sector was calculated through Equations (1), (2), (3), (4) as shown as in Table 4.

Dry matter (MD_{wheat}) and grain yield of wheat (GY_{wheat}). Observed MD_{wheat} and GY_{wheat} was measured at harvest time, a randomly selected sample of 100 cm × 100 cm was taken from each plot to determine MD_{wheat} and GY_{wheat} (kg·ha⁻¹) and then converted to yield per Mg·ha⁻¹.

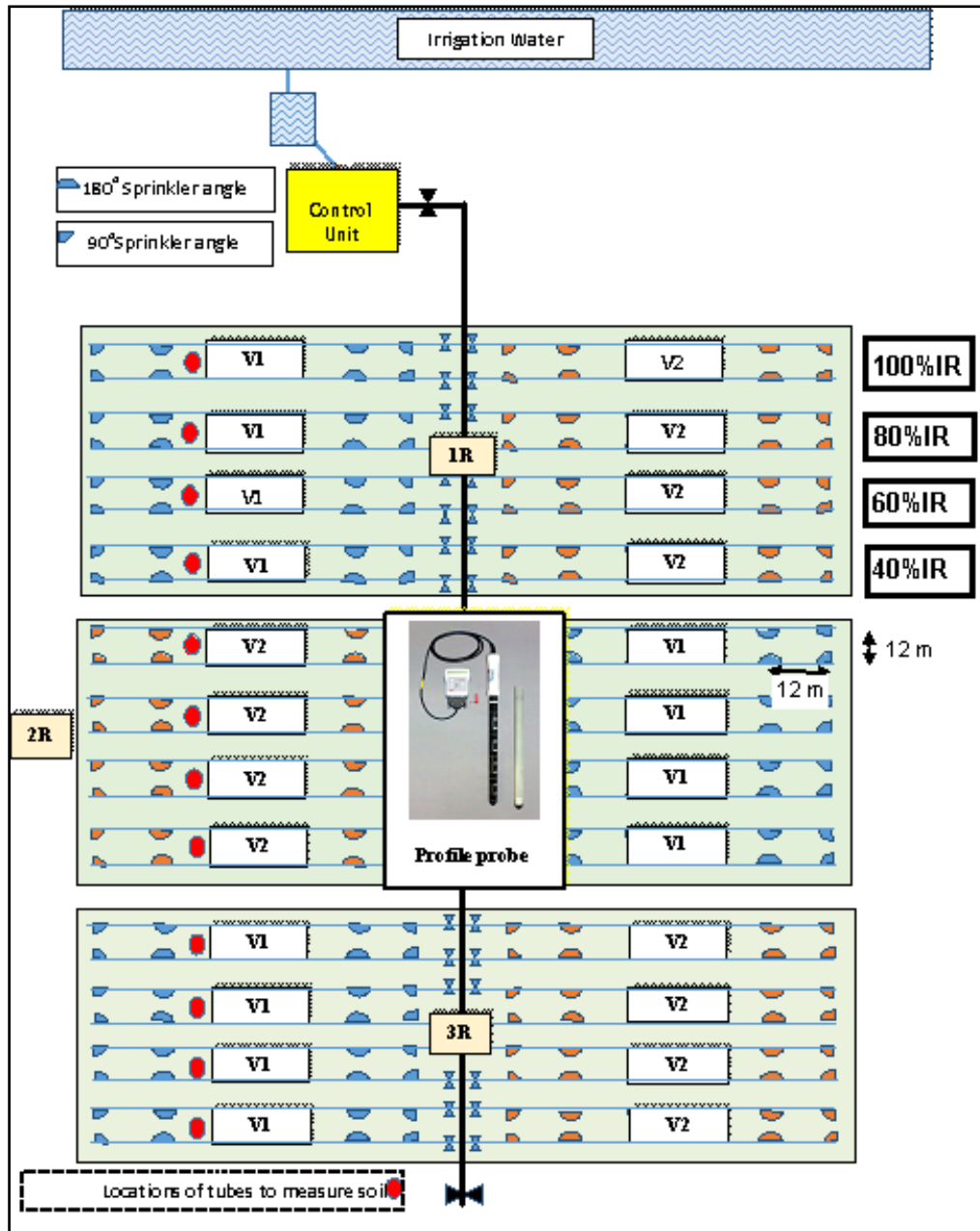

Fig. 1. Layout of experimental design; source own elaboration

Water productivity of wheat (WP_{wheat}). Observed WP_{wheat} was calculated according to [TERRY 2001] as follows:



$$WP_{\text{wheat}} = Ey/Ir \quad (5)$$

where: WP_{wheat} = water productivity of wheat ($\text{kg} \cdot \text{m}^{-3}$), Ey = the economical yield ($\text{kg} \cdot \text{ha}^{-1}$), Ir = the applied amount of irrigation water ($\text{m}^3 \cdot \text{ha}^{-1}$ per season).

SALTMED model. Model calibration was performed for each of the two wheat varieties in the study individually due to the different growth and other characteristics of each variety Table 5 and the simulated SMC , GY_{wheat} and MD_{wheat} for 100% IR were compared with the measured values

during 2015/2016 season by fine-tuning the relevant SALTMED model parameters. A model validation was carried out using the remaining treatments (using the calibrated parameter) by comparing simulated RV_{wheat} , MD_{wheat} , GY_{wheat} and WP_{wheat} with the observed varieties for both experimental seasons. Statistical and graphical methods were used to evaluate the model performance. For the model's statistical measures, the coefficient of determination (R^2), root mean square error ($RMSE$) and the coefficient of residual mass (CRM) were used. The CRM is a measure of the tendency of the model to over or underestimate the measurements. For a perfect fit between observed and simulated data, values of $RMSE$, CRM and R^2 should equal to 0.0, 0.0, and 1.0, respectively.

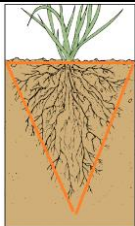
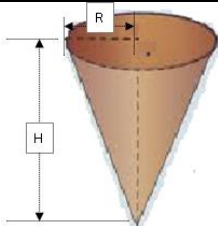
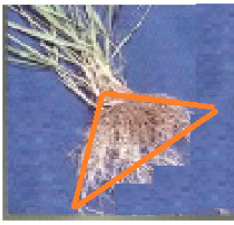
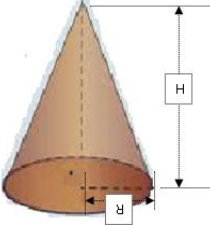
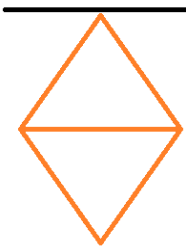
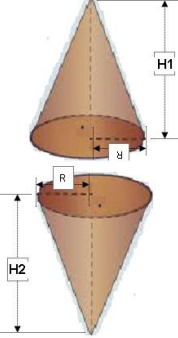
Table 4. Observed and simulated root volume (RV)

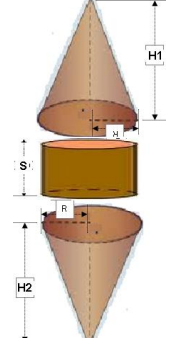
Case number	Root shape in the soil	3D shape of the true volume of the wheat plant roots	Observed root volume equation
1			$RV = (3.14R^2 \cdot H)/3$ (1)
2			$RV = (3.14R^2 \cdot H)/3$ (2)
3			$RV = (3.14R^2 \cdot H_1)/3 + (3.14R^2 \cdot H_2)/3$ (3)
4			$RV = (3.14R^2 \cdot H_1)/3 + (3.14R^2 \cdot H_2)/3 + 3.14R^2 \cdot S$ (4)

Source: own elaboration.

Table 5. Calibrated values of input parameters of two wheat varieties, 2015/2016 Egypt

Parameter	Growth stage	'Sakha 94'	'Sakha 93'
Sowing date	–	18 th November	18 th November
Harvest (day after sowing)	–	150	155
Age stages of wheat plants	initial	28	30
	development	34	35
	middle	52	53
	late	36	37
Crop coefficient (K_c)	initial	0.71	0.65
	middle	1.15	1.12
	end	0.45	0.44
Leaf area index (LAI)	initial	0.62	0.60
	middle	3.53	3.49
	end	3.06	3.00
Minimum root depth (m)	–	0.00	0.00

Maximum root depth (m)	–	0.60	0.55
Unstressed crop yield ($Mg \cdot h^{-1}$)	–	7.90	7.1
Water uptake threshold	initial	0.90	0.89
	middle	0.50	0.52
	end	0.75	0.74
Harvest index	–	0.48	0.42
Saturated moisture content ($m^3 \cdot m^{-3}$)	–	0.25	0.25
Field capacity ($m^3 \cdot m^{-3}$)	–	0.15	0.15
Wilting point ($m^3 \cdot m^{-3}$)	–	0.04	0.04
Lambda pore size	–	0.20	0.20
Residual water content ($m^3 \cdot m^{-3}$)	–	0.00	0.00
Root width factor		0.30	0.28
Maximum depth for evaporation (mm)		50.00	45
Bubbling pressure (cm)		10.00	10.00

Source: own elaboration.

RESULTS AND DISCUSSIONS

SOIL MOISTURE CONTENT (SMC)

SMC inside the root zone was investigated after the field and modelling study, for deficit irrigation strategy of the two wheat varieties under sandy soil conditions. Figure 2 shows the effect of scheduling the irrigation deficit on soil moisture stress for roots of two varieties of wheat ('Sakha 94' and 'Sakha 93') at peak irrigation during season 2015/2016. The moisture stress of the soil inside the root zone was increased by gradually decreasing the amount of irrigation water added. It was at the minimum moisture stress when adding 100% IR followed by 80% and then 60%. For the majority of treatments the wheat suffered from severe moisture stress when adding 40% IR. From the form of Equation (2) shows that there are no clear significant differences between the moisture stress within the root zone when adding 100% and 80% IR. Initially the SMC was calibrated with two wheat varieties, 100% IR and validated against all the other treatments for two seasons 2015/2016 and 2016/2017. The model calibration simulated the SMC for layer (0–30 cm depth) as shown in Figure 3 for 2015/2016 season and was validated for 2016/2017 season.

Overall, the model was able to simulate reasonably well the observed data during both the calibration and validation processes. These results are consistent with many studies [ABDELRAOUF, RAGAB 2017; 2018; FGHIRE *et al.* 2015; PULVENTO *et al.* 2015; RAMESHWARAN *et al.* 2015]. The model showed slightly higher values for the R^2 during 2015/2016 for the layer (0–30 cm). A good correlation between the simulated and observed outcomes was obtained for the 2015/2016 season. Table 6 indicates that, the

SALTMED model proved its high sensitivity to simulate the SMC changes caused by irrigation events.

ROOTS' VOLUME (RV_{WHEAT})

The RV_{wheat} for the two wheat varieties were investigated after the field and modelling study for the deficit irrigation strategy on under sandy soil conditions. Figure 4 shows the effect of scheduling irrigation deficit on RV_{wheat} of two varieties of wheat ('Sakha 94' and 'Sakha 93') at 50 days of plant age. In general, the RV_{wheat} decreased by decreasing the amount of irrigation water added. However, the highest value of RV_{wheat} was achieved when adding 80% IR and not when adding 100%. This may be due to an increase in stimulating vertical root growth alongside horizontal root growth when adding 80% IR while vertical growth was less when adding 100% IR. The RV_{wheat} was negatively affected when adding 60% and 40% IR only. The vertical growth of roots greatly increased at the expense of horizontal root growth, which negatively affected the RV_{wheat} in the effective area of root growth. Figure 4 shows a clear superiority of the RV_{wheat} of the 'Sakha 94' variety compared to the 'Sakha 93' variety under all conditions during the two seasons of the study, possibly due to the genetic superiority of the 'Sakha 94' variety. Figures 4 and 5 indicate that, clear correlations between the simulated and observed roots were obtained for the 2015/2016 and 2016/2017 seasons and R^2 was 0.95 which means that the SALTMED model proved its high sensitivity to simulate the RV_{wheat} caused by irrigation events and wheat varieties. Overall, the simulated and the observed RV_{wheat} for all treatments combined showed a strong correlation for the two seasons 2015/2016 and 2016/2017.

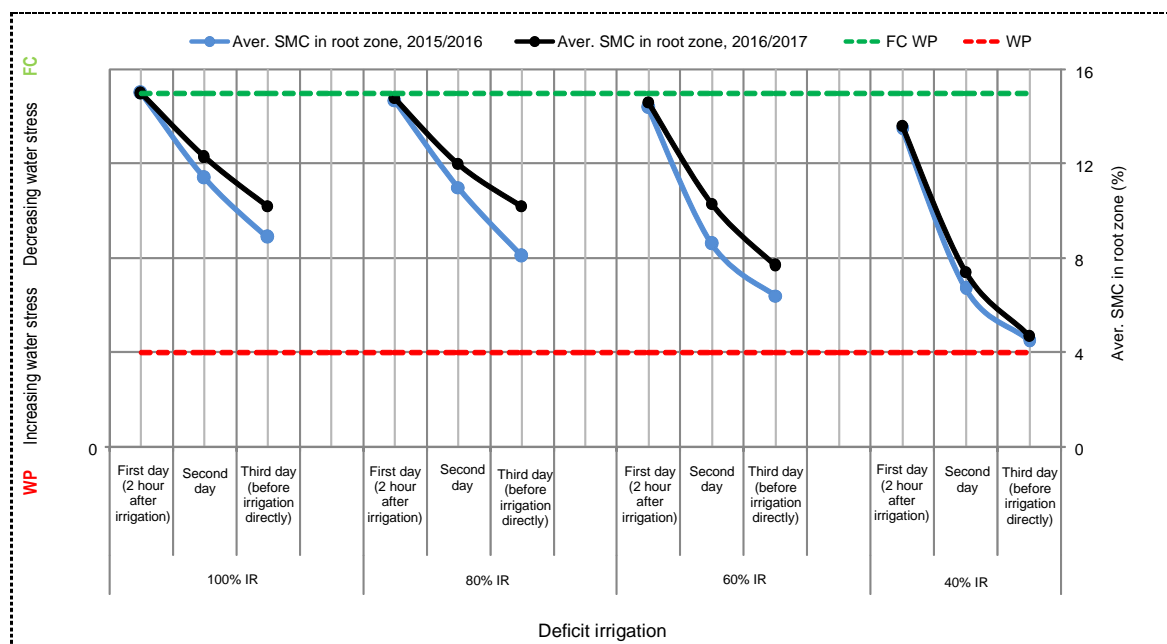

Fig. 2. Effect of deficit irrigation scheduling on soil moisture stress for roots of two varieties of wheat ('Sakha 94' and 'Sakha 93') at peak irrigation during season 2015/2016; source: own study

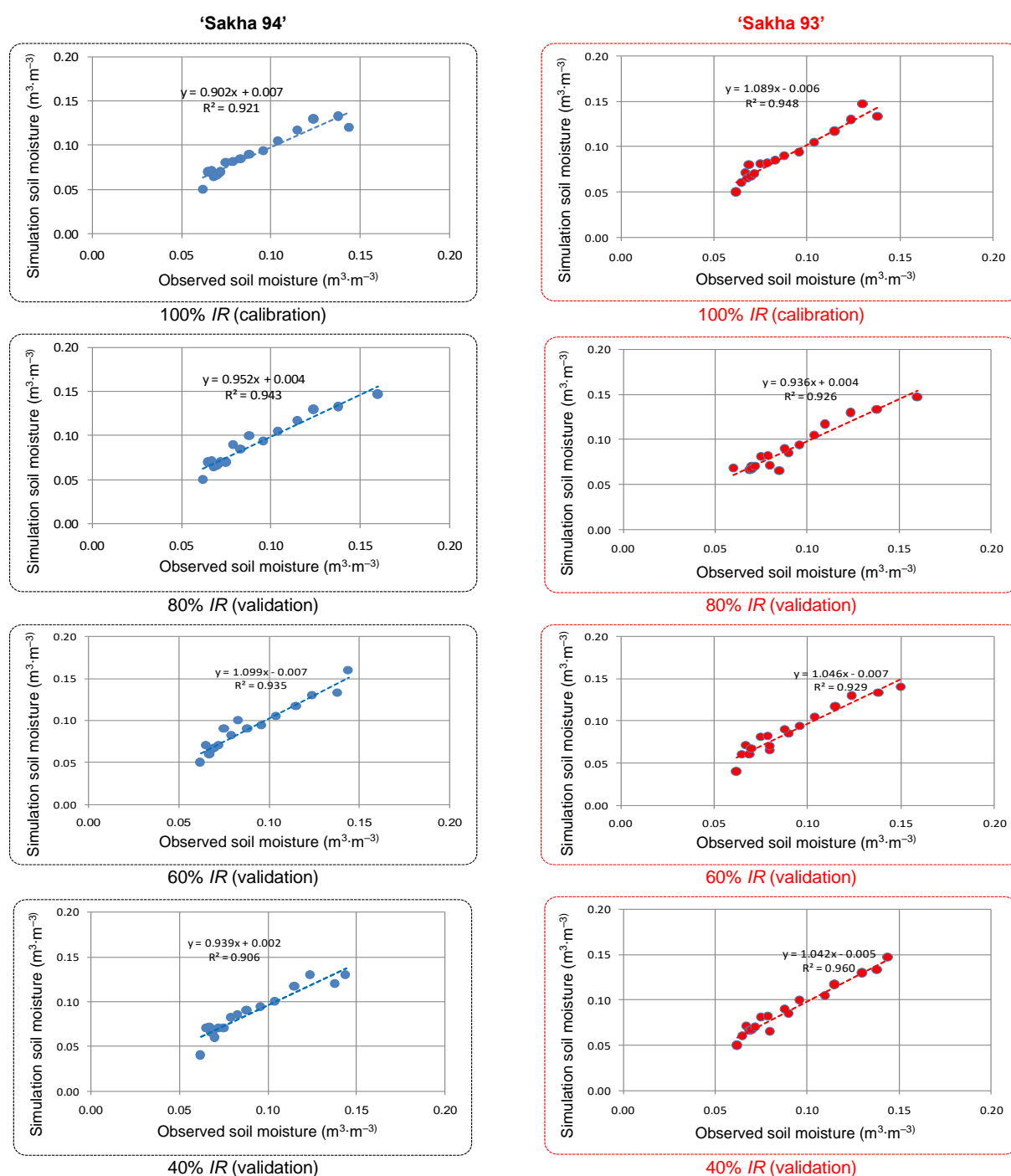

Fig. 3. Correlation between observed and simulated soil moisture for 100%, 80%, 60% and 40% irrigation requirements (IR) during 2015/2016 season, simulated with SALTMED as calibration and validation and the same trend was repeated with the 2016/2017 season; source: own study

Table 6. Statistical parameters for soil moisture in one layer (0–30 cm) for two wheat varieties and all irrigation treatments under deficit irrigation strategy during the 2015/2016 and 2016/2017 seasons

Season	Correlation parameter	Variety							
		'Sakha 94'				'Sakha 93'			
		100% IR	80% IR	60% IR	40% IR	100% IR	80% IR	60% IR	40% IR
2015/2016	R ²	0.92	0.94	0.93	0.90	0.94	0.92	0.92	0.96
	RMSE	-0.01	-0.011	0.0077	0.008	0.0080	0.0092	0.0091	0.0072
	CRM	-0.014	-0.022	-0.034	-0.040	-0.0228	-0.014	-0.014	0.0247
2016/2017	R ² , RMSE, CRM	The same trend							

Explanations: R² = the coefficient of determination, RMSE = root mean square error, CRM = coefficient of residual mass. Source: own study.

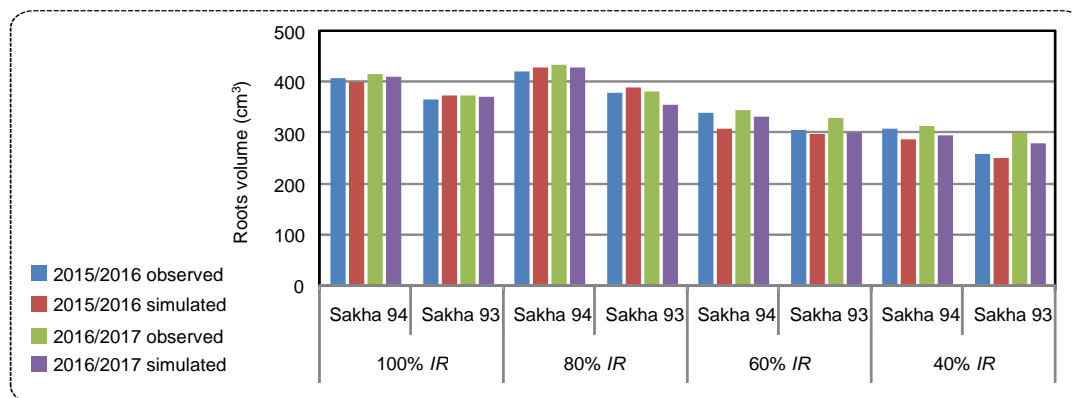

Fig. 4. Effect of deficit irrigation strategy and varieties on roots volume of wheat at 50 days from plant age and compared to simulated roots volume for all treatments; source: own study

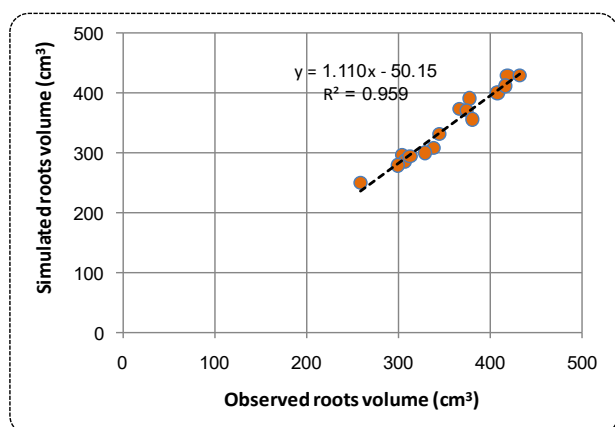

Fig. 5. Observed versus simulated roots volume of wheat plant for all treatments for seasons 2015/2016 and 2016/2017; source: own study

DRY MATTER (MD_{WHEAT}) AND GRAIN YIELD (GY_{WHEAT}) OF WHEAT

The MD_{wheat} and GY_{wheat} for two wheat varieties were investigated after field and modelling studies for deficit irrigation strategy on under sandy soil conditions. Table 7 and Figure 6 show the effect of scheduling irrigation deficit on MD_{wheat} and GY_{wheat} during the growing seasons

2015/2016 and 2016/2017. The MD_{wheat} and GY_{wheat} decreased by reducing the amount of irrigation water added, this was due to an increase in soil moisture stress by decreasing the amount of added irrigation water and also, decreasing of root volume. This negatively affected the absorption of water and nutrients in the root zone of wheat plants, which ultimately affected on the MD_{wheat} and GY_{wheat} . The values of MD_{wheat} and GY_{wheat} increased with the ‘Sakha 94’ variety compared to the ‘Sakha 93’ class.

Table 7. Effect of deficit irrigation scheduling, varieties and interaction on dry matter and grain yield of wheat

Irrigation deficit (%)	Variety	Dry matter ($Mg \cdot ha^{-1}$)				Grain yield ($Mg \cdot ha^{-1}$)			
		2015/2016		2016/2017		2015/2016		2016/2017	
		O	S	O	S	O	S	O	S
Effect of deficit irrigation scheduling on the dry matter and grain yield of wheat									
100% IR	-	15.8a		16.6a		7.9a		8.4a	
80% IR		16.1a		16.3a		8.4a		8.4a	
60% IR		13.0b		13.2b		7.0b		7.0b	
40% IR		9.1c		9.4c		4.3c		4.6c	
LSD at 5%		0.74		0.74		0.51		0.48	
Effect of varieties on dry matter and grain yield of wheat									
-	‘Sakha 94’	13.9a		14.4a		7.4a		7.4a	
	‘Sakha 93’	13.0b		13.2b		6.5b		6.7b	
LSD at 5%		0.70		0.70		0.50		0.52	
Effect of interaction between deficit irrigation and varieties on dry matter and grain yield of wheat									
100% IR	‘Sakha 94’	16.3	15.8	17.0	16.3	8.4	8.7	8.9	9.1
	‘Sakha 93’	15.4	15.0	16.1	15.5	7.4	7.5	7.9	8.0
80% IR	‘Sakha 94’	16.6	15.6	16.8	15.2	8.6	9.0	8.6	8.5
	‘Sakha 93’	15.6	14.8	15.8	15.1	7.9	8.1	7.9	8.0
60% IR	‘Sakha 94’	13.7	14.0	13.9	14.0	7.2	7.5	7.2	7.5
	‘Sakha 93’	12.2	11.5	12.5	11.4	6.5	6.1	6.7	6.6
40% IR	‘Sakha 94’	9.6	9.2	9.8	9.5	4.8	5.0	5.0	5.2
	‘Sakha 93’	8.6	7.6	8.9	8.1	3.6	4.2	3.8	4.0
		$Y = 0.98X - 0.368, R^2 = 0.977$ (Y = simulated dry matter, X = observed dry matter)							
LSD at 5%		n.s		n.s		n.s		n.s	

Explanations: O = observed value, S = simulated value, IR = irrigation requirements, n.s. = no significant differences between the yield values. Source: own study.

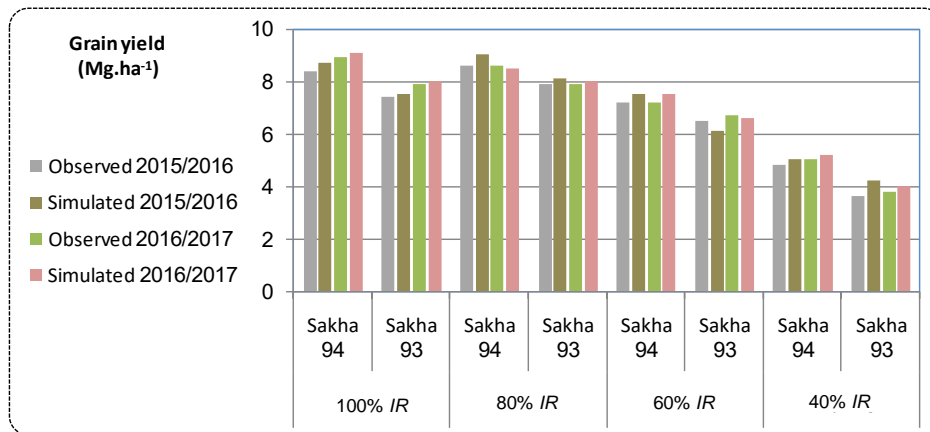

Fig. 6. Effect of deficit irrigation strategy and varieties on grain yield and compare it to simulated grain yield for all treatments; source: own study

Perhaps this was due to the increase in the genetic characteristic of the root size of the ‘Sakha 94’ variety compared to the ‘Sakha 93’ class, as this increase led to the absorption of water and nutrients from a larger volume of root spread as shown as in Figure 6. Figures 6 and 7 indicated that, good

correlation between observed and the simulated MD_{wheat} and GY_{wheat} for all treatments during the two seasons with R^2 of 0.97 for MD_{wheat} as shown as in Table 7 and R^2 of 0.98 for GY_{wheat} as shown as in Figure 7 for all treatments.

WATER PRODUCTIVITY OF WHEAT (WP_{wheat})

Figure 8 contains the effect of deficit irrigation, i.e., 100%, 80%, 60% and 40% IR on WP_{wheat} during two growing seasons 2015/2016 and 2016/2017. Despite increasing the WP_{wheat} by decreasing the amount of added irrigation water, the two highest productivity values were achieved when adding 100% and 80% IR required to irrigate the wheat and there were no significant differences between the productivity values at 100% and 80% IR, so we recommend wheat irrigation at 80% IR and which will provide 20% IR for irrigation more area. When comparing the WP_{wheat} of the two wheat cultivars under the study, it became clear that ‘Sakha 94’ was superior to ‘Sakha 93’ when adding the same amount of irrigation water, and this resulted from increased WP_{wheat} for ‘Sakha 94’.

Figures 8 and 9 indicated that, good correlation between observed and the simulated WP_{wheat} for all treatments during the two seasons with R^2 of 0.93.

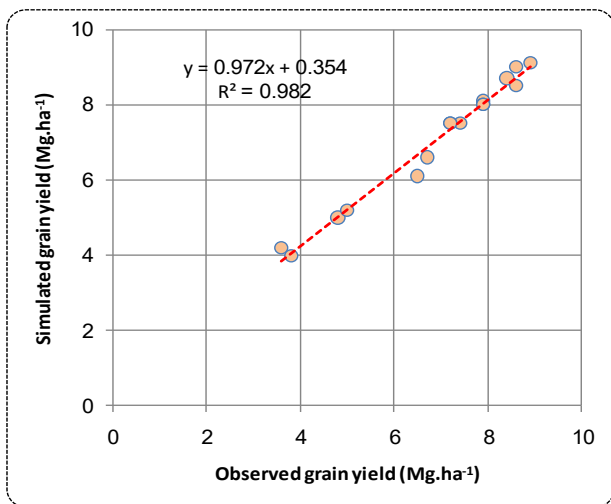

Fig. 7. Observed versus simulated grain yield for all treatments for seasons 2015/2016 and 2016/2017; source: own study

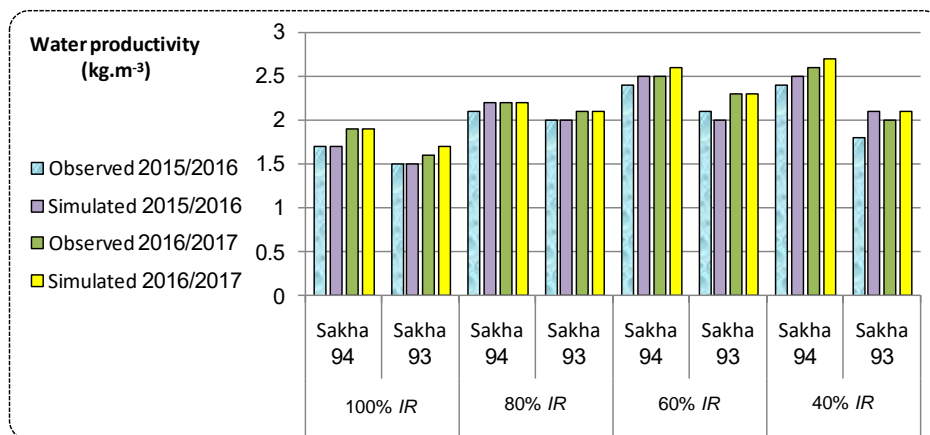

Fig. 8. Effect of deficit irrigation strategy and varieties on water productivity and compare it to simulated water productivity for all treatments; source: own study

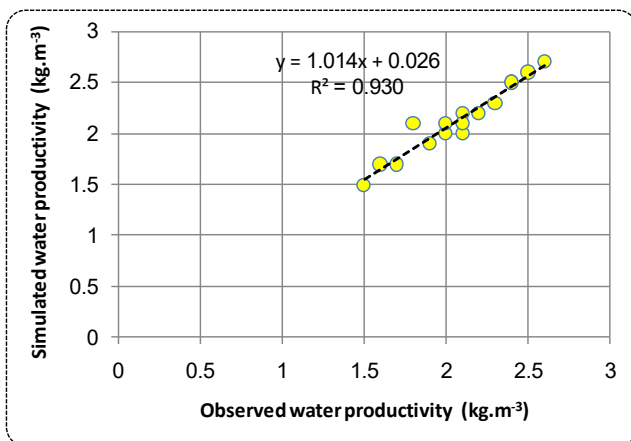

Fig. 9. Observed versus simulated water productivity for all treatments for seasons 2015/2016 and 2016/2017; source: own study

CONCLUSIONS

The dry matter and grain yield of wheat decreased by reducing the amount of irrigation water added, this was due to the rise in the soil moisture stress as a result of decreasing the amount of irrigation water added and additionally by decreasing the root volume. This negatively affected the absorption of water and nutrients in the root zone of wheat plants, which ultimately affected the dry matter and grain yield of wheat. The values of dry matter and grain yield of wheat increased with the 'Sakha 94' variety compared to 'Sakha 93' class. Perhaps this was due to the increase in the genetic characteristic of the root size with the 'Sakha 94' variety compared to the 'Sakha 93' class, as this increase led to the absorption of water and nutrients from a larger volume of root spread.

Despite increasing the water productivity of wheat by decreasing amount of added irrigation water, the two highest grain yield values were achieved when adding 100% and 80% of *IR* required to irrigate the wheat and there were no significant differences between the yield values at 100% and 80% of *IR*, so we recommend irrigating wheat at 80% of *IR* and which will provide 20% *IR*. 'Sakha 94' was superior to 'Sakha 93' when adding the same amount of irrigation water, and this resulted from increased wheat productivity for 'Sakha 94'. The SALTMED results confirmed a strong accuracy in simulating soil moisture, roots volume, dry matter and grain yield for two varieties of wheat under water deficit irrigation conditions under sandy soils in Egypt.

REFERENCES

ABDELRAOUF R.E., RAGAB R. 2017. The benefit of using drainage water of fish farms for irrigation: field and modelling study using the SALTMED model. *Irrigation and Drainage*. Vol. 66 p. 758–772. DOI [10.1002/ird.2180](https://doi.org/10.1002/ird.2180).

ABDELRAOUF R.E., RAGAB R. 2018. Effect of fertigation frequency and duration on yield and water productivity of wheat: Field and modelling study using the SALTMED model. *Irrigation and Drainage*. Vol. 67 p. 414–428. DOI [10.1002/ird.2232](https://doi.org/10.1002/ird.2232).

ABDELRAOUF R.E., ABOU-HUSSEIN S.D., ABD-ALLA A.M., ABDALLAH E.F. 2012. Effect of short irrigation cycles on soil moisture distribution in root zone, fertilizers use efficiency and

productivity of potato in new reclaimed lands. *Journal of Applied Sciences Research*. Vol. 8(7) p. 3823–3833.

BAKRY A.B., ABDELRAOUF R.E., AHMED M.A., EL KARAMANY M.F. 2012. Effect of drought stress and ascorbic acid foliar application on productivity and irrigation water use efficiency of wheat under newly reclaimed sandy soil. *Journal of Applied Sciences Research*. Vol. 8(8) p. 4552–4558.

CHENCHOUNI H. 2017. Edaphic factors controlling the distribution of inland halophytes in an ephemeral salt lake 'Sabkha ecosystem' at North African semi-arid lands. *Science of The Total Environment*. Vol. 575 p. 660–671. DOI [10.1016/j.scitotenv.2016.09.071](https://doi.org/10.1016/j.scitotenv.2016.09.071).

DEL POZO A., YANEZ A., MATUS I.A., TAPIA G., CASTILLO D., SANCHEZ-JARDON L. 2016. Physiological traits associated with wheat yield potential and performance under water-stress in a Mediterranean environment. *Frontiers in Plant Science*. Vol. 7, 987. DOI [10.3389/fpls.2016.00987](https://doi.org/10.3389/fpls.2016.00987).

EL-HABBASHA S.F., OKASHA E.M., ABDELRAOUF R.E., MOHAMMED A.S.H. 2014. Effect of pressured irrigation systems, deficit irrigation and fertigation rates on yield, quality and water use efficiency of groundnut. *International Journal of ChemTech Research*. Vol. 07(01) p. 475–487.

EL-METWALLY I., ABDELRAOUF R.E., AHMED M., MOUNZER O., ALARCÓN J., ABDELHAMID M. 2015. Response of wheat (*Triticum aestivum* L.) crop and broad-leaved weeds to different water requirements and weed management in sandy soils. *Agriculture*. Vol. 61(1) p. 22–32. DOI [10.1515/agri-2015-0005](https://doi.org/10.1515/agri-2015-0005).

FANG W. B., SAKIH M.K., NUDI Y.B. 2006. Effect of water stress with physic development on yield of wheat grown in semi-arid environment. *Field Crops Research*. Vol. 5(3) p. 55–67.

FGHIRE R., WAHBI S., ANAYA F., ISSA ALI O., BENLHABIB O., RAGAB R. 2015. Response of quinoa to different water management strategies: Field experiments and SALTMED model application results. *Irrigation and Drainage*. Vol. 64 p. 29–40. DOI [10.1002/ird.1895](https://doi.org/10.1002/ird.1895).

HOZAYN M., ABD EL-WAHED M.S.A., ABD EL-MONEM A.A., ABDELRAOUF R.E., ABD ELHAMID E.M. 2016. Applications of magnetic technology in agriculture, a novel tool for improving water and crop productivity: 3. Faba bean. *Research Journal of Pharmaceutical, Biological and Chemical Sciences*. Vol. 7(6) p. 1288–1296. DOI [10.5897/AJAR2015.9382](https://doi.org/10.5897/AJAR2015.9382).

JIN M.G., ZHANG R.Q., GAO Y.F. 1999. Temporal and spatial soil water management: A case study in the Heilonggang region, PR China. *Agricultural Water Management*. Vol. 4 (2) p. 173–187. DOI [10.1016/S0378-3774\(99\)00039-6](https://doi.org/10.1016/S0378-3774(99)00039-6).

KAMBOU D., XANTHOULIS D., OUATTARA K., AURORE D. 2014. Concepts d'efficienceet de productivité de l'eau (synthèse bibliographique) [Water efficiency and productivity concepts. A review]. *Biotechnology, Agronomy, Society and Environment*. Vol. 18(1) p. 1–13.

LUO Q., O'LEARY G., CLEVERLY J., EAMUS D. 2018. Effectiveness of time of sowing and cultivar choice for managing climate change: wheat crop phenology and water use efficiency. *International Journal of Biometeorology*. Vol. 62(6) p. 1049–1061. DOI [10.1007/s00484-018-1508-4](https://doi.org/10.1007/s00484-018-1508-4).

MARWA M.A., ABDELRAOUF R.E., WAHBA S.W., EL-BAGOURI K.F., EL-GINDY A.G. 2017. Scheduling irrigation using automatic tensiometers for pea crop. *Agricultural Engineering International: CIGR Journal*. Special issue p. 174–183.

MIHOUB A., MOKHTARI S. 2016. Effects of water quality on wheat (*Triticum durum* L. var. Boussalem) irrigated with drainage water in a saline environment under palm grove conditions, southern Algeria. *Algerian Journal of Arid Regions*. Vol. 13 p. 97–100.

PULVENTO C., ARICCARDI M., LAVINI A., D'ANDRIA R., RAGAB R. 2015. Parameterization and field validation of SALTMED

- model for grain amaranth tested in South Italy. *Irrigation and Drainage*. Vol. 64 p. 59–68. DOI [10.1002/ird.1905](https://doi.org/10.1002/ird.1905).
- RAMESHWARAN P., TEPE A., RAGAB R. 2015. The effect of saline irrigation water on the yield of pepper: Experimental and modelling study. *Irrigation and Drainage*. Vol. 64 p. 41–49. DOI [10.1002/ird.1867](https://doi.org/10.1002/ird.1867).
- SHIFERAW B., SMALE M., BRAUN H. J., DUVEILLER E., REYNOLDS M., MURICHO G. 2013. Crops that feed the world 10. Past successes and future challenges to the role played by wheat in global food security. *Food Security*. Vol. 5 p. 291–317. DOI [10.1007/s12571-013-0263-y](https://doi.org/10.1007/s12571-013-0263-y).
- TERRY A., HOWELL 2001. Enhancing water use efficiency in irrigated agriculture. *Agronomy Journal*. No. 93 p. 281–289. DOI [10.2134/agronj2001.932281x](https://doi.org/10.2134/agronj2001.932281x).
-