

Adam Sajek

ALUMINUM FOAMS GLUING

KLEJENIE PIAN ALUMINIOWYCH

Abstract

The paper presents an example of design solution of aluminum foam glue joint using two-component epoxy glue. The joint principles for distribution forces and stresses in the tensile sample were formulated. Recommendations for surface preparation of foam and gluing procedure aimed at control the porosity of the foam and glued surface roughness were established. As a result of strength tests defined joint destruction mechanism was proposed. It was suggested that optimized joint design improving its properties.

Keywords: glue joint, aluminum foams, gluing, mechanical tests

Streszczenie

W artykule przedstawiono przykład rozwiązania konstrukcji złącza klejowego piany aluminiowej wykonanego za pomocą dwuskładnikowego kleju epoksydowego. Sformułowano założenia dla złącza dotyczące rozkładu sił i naprężeń w rozciąganej próbce. Ustalono zalecenia do przygotowania powierzchni pian, procedurę klejenia uwzględniającą kontrolę porowatości piany i chropowatości klejonej powierzchni blachy. W wyniku badań wytrzymałościowych określono mechanizm niszczenia złącza. Zaproponowano optymalizację konstrukcji złącza poprawiającą jego właściwości.

Słowa kluczowe: złącze klejowe, piana aluminiowa, klejenie, badania wytrzymałościowe

1. Introduction

Aluminum foams are specific construction materials, with porosity frequently exceeding 90%. Main properties of Al foams are: low density, high stiffness, ability to absorb energy, attenuation of acoustic waves and mechanical vibration.

Properties of Al foams determine their numerous applications in fields such as transportation, aviation, aeronautics. Aluminum foams are also utilised in shipbuilding as components in parts such as doors, hatches, ribs, cargo area reinforcements or panels.

Effective application of aluminum foams requires efficient methods that provide durable joint, taking its working conditions as well as possible loads into account [1].

Typical joining methods used for aluminum foams are bolted joints, soldering, gluing, welding [2].

2. Aluminum foam gluing

Gluing may prove to be the most effective technique in many applications, especially low process temperature is an advantage, thus joining does not affect foam metal wall crystal structure. Due to high porosity of aluminum foams, which may exceed 90%, bonding entails numerous limitations [2]. Only few investigations concerning methods of gluing aluminum foams have been conducted.

According to research made to date, gluing metallic foams can be conducted using adhesives used to join non porous aluminum. Glue joints obtained this way are usually stronger than the foam itself [3–5]. However, using thermal cured epoxy glues, cured in 180°C at time of 30 min is advised [6].

While in a number of publications it is stated that adhesive bonding is a useful method of joining aluminum foams, some researchers claim that utilising thermal expanding glues could make it possible to bridge presumptive gaps resulting from imperfect fitting of elements to be joined [7].

Nowacki J. at all have developed a method of preparing aluminum foam edges for bonding. They have also investigated methods of soldering, achieving high joint strength, equaling or exceeding strength of parent material [8, 9].

Most of mentioned publications focus on other matters, leaving the topic of adhesive bonding described very generally [10, 11].

Subject of adhesive bonding metallic foams is often undervalued and treated as an addition, for example in process of joining specimens intended to be further examined. Main aim of this work is to investigate joining procedure, as well as behavior of joint components under increasing stress.

3. Joint design assumptions

Essential assumption that has to be made while designing a joint is a proper tension orientation. In considered joint type, shear stress should prevail, concentrating in glue joint and causing its destruction.

An overlapping joint between aluminum sheet, serving as a grip section, and aluminum foam has been designed. As a grip section, a sheet of AlSi9Mg (AK9) has been used. The foam has been produced by direct foaming of melt, using AlSi9 casting alloy. As an adhesive, epoxy glue Loctite Hysol 9489 has been used.

Results of calculations are presented in Table 1. The results show that lowest pulling load, 7.4 kN, will be carried by the glue joint, followed by a sheet metal. For aluminum foam, being most non uniform and thus least dependent component of the joint, the pulling force is over twice higher than for glue.

A test specimen according to Figure 1 has been constructed.

Table 1. Calculated values destructive forces for the shear strength test sample

Material	Dimensions a x b, mm	Quantity	Carrying surface S_0 , mm ²	Tensile strength $R_m (R_s)$, MPa	Destruction force $F_m (F_s)$, kN
Plate	1.5 x 25.0	1	37.5	283.0	10.6
Aluminium foam	20.0 x 25.0	2	1000.0	15.0	15.0
Glue	12.5x 25.0	2	625.0	11.8	7.4

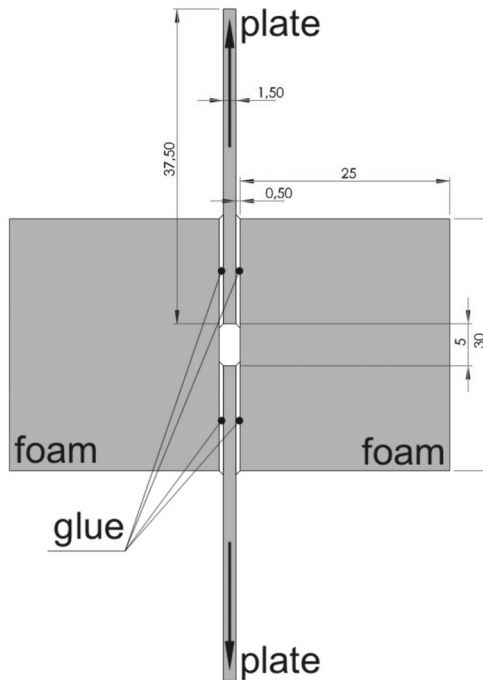

Fig. 1. The shear test sample

Introductory simulations of stress and deformation distribution using finite element method module built in SolidWorks Simulation 2013 suite have been made. Study has been conducted on discrete 2D model, based on transverse section of testing specimen presented in Figure 2. Parameters of materials used in FEM analysis are shown in Table 2.

Numerical analyses of joint under stress, shown in Figure 2 indicate that concentration of stress as well as deformation occurs in a layer of adhesive. In actually conducted static shear strength test, initial assumptions for directions and types of stress in joint will be met.

Table 2. Material data used in the FEM analysis for the joint elements

Designation	R_e , N/mm ²	R_m , N/mm ²	E, N/mm ²	ν	ρ , g/cm ³
Foam AISi9	1.40	1.62	200	0.33	240
Epoxy glue	–	28.0	2415	0.35	1100
Plate AK9	55.1	124.1	69000	0.33	2700

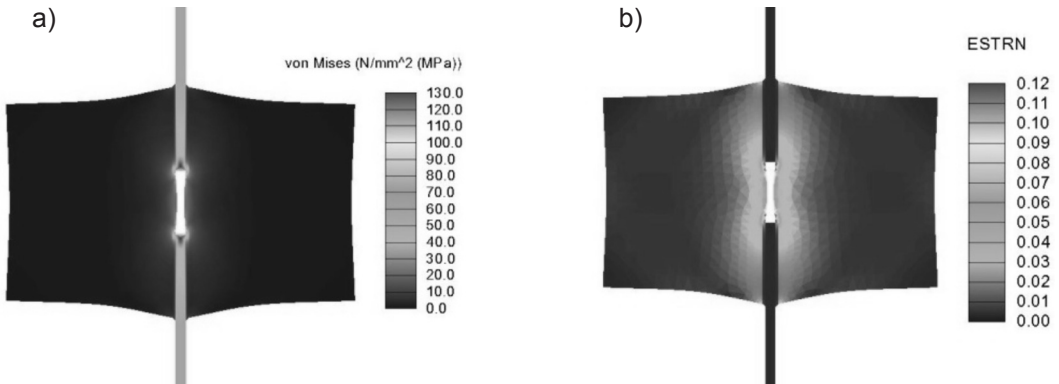

Fig. 2. Results of numerical analysis designed joint: a) stress distribution, b) strain distribution

4. Glued specimens production procedure

The foam was cut using semiautomatic disc cutting machine PRESI Metacome T300, which allows to control of basic working parameters: rotation speed that was set to 3000 rpm and feed rate: 50 mm/min. Cutting has been performed dry, as it would be problematic to remove traces of liquid coolant after the process. Two types of cutting disks have been used: PFERD SG-ELASTIC – a standard disc, intended to be used for cutting construction steels, and PRESI MNF – designated to cut aluminum.

After cutting foam specimens, a macroscopic evaluation of resultant surfaces has been made. Considerable edge quality differences have been observed, what has been presented in Figure 3.

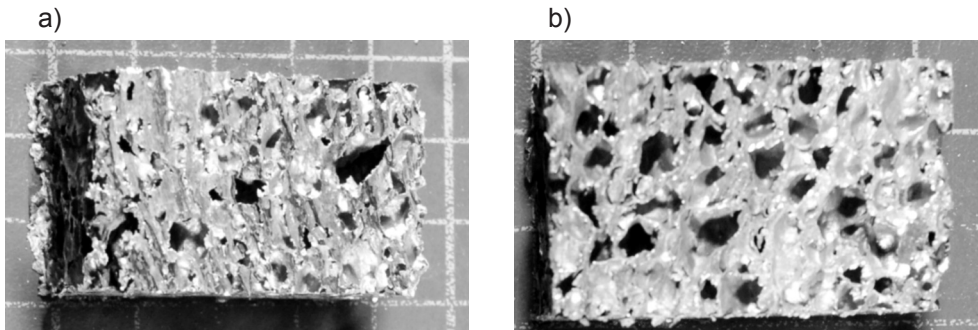

Fig. 3. The result of macroscopic examination of cut surface of the aluminum foam: a) highly deformed PFERD system cut surface, b) high quality aluminum foam with developed surface cut by PRESI system

Surface obtained by cutting with disc designed for cutting construction steel shows many plastic deformations. These deformations are patterned upon paths guided by the cutting disc movement. Figure 3 shows pores covered with not entirely cut fragments of foam structure. These fragments instead of being pulled out, have been bent into foam structure during cutting. In contrary to previous case, surfaces of specimens cut with PRE-SI MNF aluminum cutting disc are free of deformation and the pores are exposed.

After cutting specimens, porosity has been measured. Method combining weighing, using laboratory scale AXIS AD500 providing accuracy of 0.001 g, and calculations was used. Porosity of individual specimens was calculated using following formula:

$$p = \left(1 - \frac{m}{v \cdot \rho_{Al}}\right) \cdot 100\%$$

where:

- p – porosity of aluminum foam, %;
- v – volume of aluminum foam specimen, cm³;
- m – weight of aluminum foam specimen, g;
- ρ_{Al} – density of AlSi9 alloy – 2.65 g/cm³.

Mean calculated porosity is 91.1%, standard deviation is 0.465 what indicates accuracy of scale method and homogeneity of porous structure.

Due to necessity of proper preparation of surface for adhesive bonding, according to manufacturer of utilised glue, the edges have been roughened with abrasive paper, with P320 gradation.

For measuring roughness, acc. to PN-EN ISO 9013:2008. A set of roughness meter Hommel Etamic T8000 RC and TK300 head has been used. The measuring parameters were: Lt: 48 mm, range: 800 μ m, ISO 11562(M1) filter, feed rate 0.5 mm/s.

Measurements presented in Figure 4 indicate, that surface machined with abrasive paper increases roughness, which in this case is improved nearly twice. Additional advantage of this operation is homogenisation of surface, which should positively affect reproducibility of strength test results.

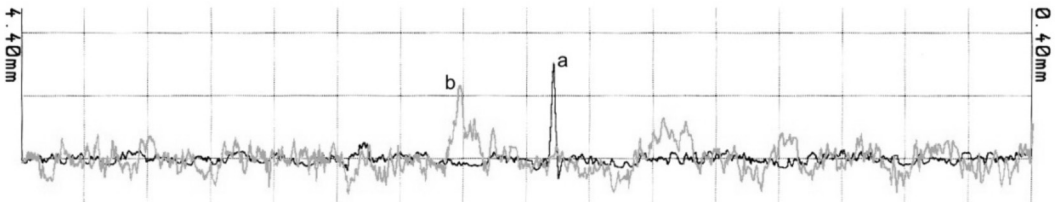

Fig. 4. The results of the roughness measurements: a) unsanded sample: Ra: 0.308 μ m; R3z: 1.18 μ m; Rz 3.09 μ m, b) grounded sample: Ra: 0.850 μ m; R3z: 3.97 μ m; Rz 5.60 μ m

The final step of test joint preparation is actual gluing. The procedure consisted of degreasing the surfaces to be joined with acetone, covering the surfaces of plates with premixed two-components adhesive, placement of graphite distancing elements, mounting of remaining elements of the joint and after applying initial pressure, removing excessive glue. According to manufacturer, time needed for the glue to fully strength; is 12 h. Strength tests have been conducted after 48 h.

5. Testing of adhesive joints

Tests have been carried out on Instron 5585H universal testing machine, controlled by Bluehill 2 software. Ambient temperature and relative humidity were measured with Thermalfabriken Viking AB thermo-hygrometer. During the test, a fragment of aluminum foam

has been torn out, while the adhesive joint remained undamaged. Strain components that led to destruction of the foam were tensile strength and bending moment, the latter caused by the sheet metal being pulled out of its location between two pieces of aluminum foams. The course of foam destruction process has been shown in a series of photographs, illustrating successive changes in specimen geometry (Fig. 5). Initial proportional deformation can be observed (Fig. 6). Rising curvature of outer foam edge leads to gradual increase of the bending moment. Failure of foam on the left side occurred due to breakage at reasonably low deformation rate. In the final phase, the foam on the right side has been torn out by the lower plate due to growth of deformation.

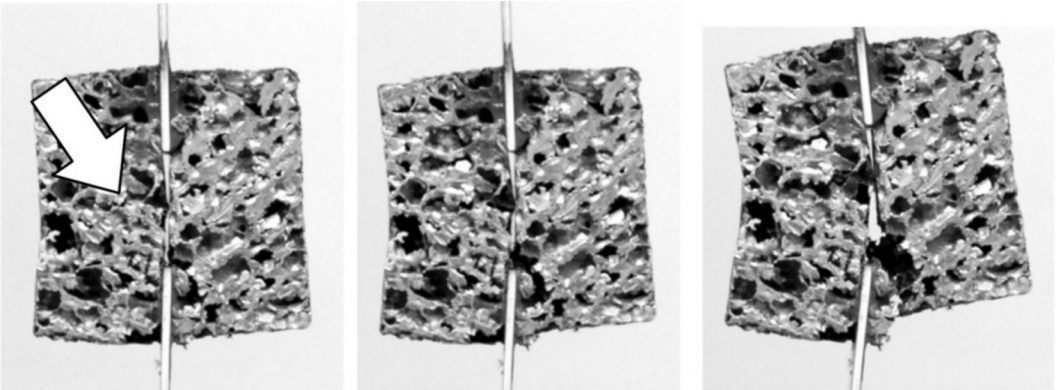

Fig. 5. Increasing tension deformation of the sample. Fracture initiating rupture marked

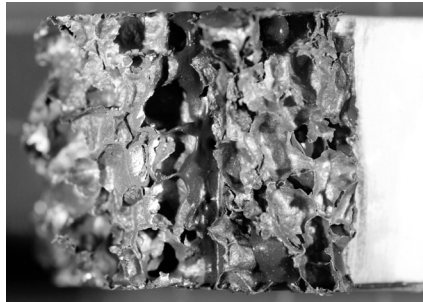

Fig. 6. Fracture of sample. Visible plastic deformation of foam metal. Course of crack leads along the surface of with the lowest strength

Example described above illustrates, that whereas porosity of aluminum foam is reasonably steady when larger volume of foam is considered, lack of structure homogeneity of aluminum foams in micro scale may lead to insufficient repeatability of test results.

The influence of utilized cutting systems on result of infiltration the foam by the adhesive is shown in Figure 7, where also effect of distance between bonded materials has been shown. Arrows point areas where small amounts of adhesive have been trapped in spaces between joined elements.

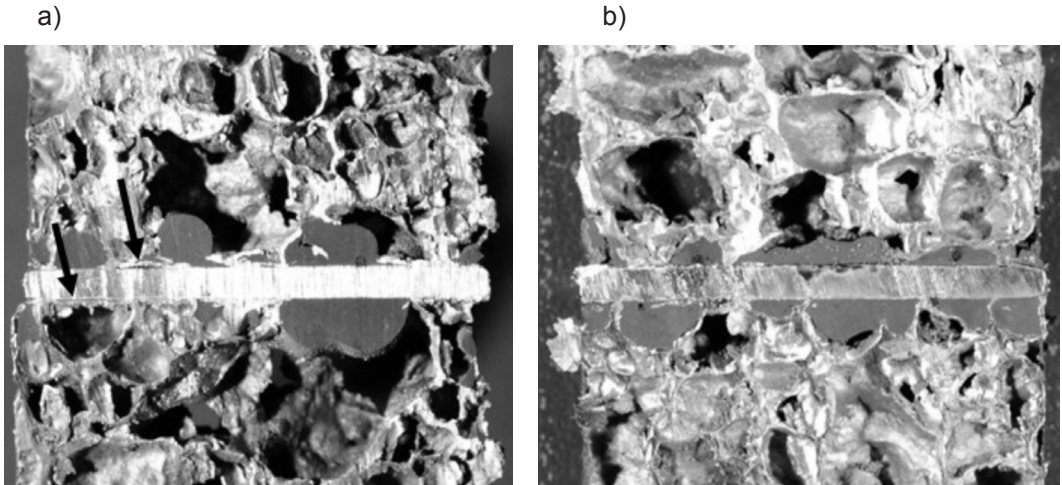

Fig. 7. Cross section of the joints on samples: a) cut PFERD system, b) cut by PRESI

6. Findings

Conducted studies have led to determining conditions of adhesive joints preparation, which, however, require further investigation to obtain trustworthy and comparable results. Additionally, procedures of joints investigation have been specified, allowing evaluation of its mechanical properties. The strength of obtained joints is considered high. During strength tests, the failure occurred in aluminum foam. The amount of glue that infiltrated the pores of foam was sufficient to provide overall strength exceeding the aluminum foam. This research paper justifies usage of cutting tools designed for cutting aluminum, what positively influences penetration of glue into the structure of foam.

During strength tests, in both cases the failure occurred in aluminum foam. Calculations prior to actual test stated, that the failure should occur in adhesive joint. The calculations have not proved to be an acceptable representation of test specimen mostly because of differences in maximal shear force, as shown in Table 1, which in test occurred to be 15 times smaller than estimated in calculations. Analysis of deformations during tensile test has led to a conclusion, that stiffening joint elements is essential. It can be achieved through application of thicker gauge sheet metal and strengthening outer surfaces by gluing additional aluminum plates. This solution may help to prevent bending of outer foam surfaces inwards and reduce overall disadvantageous bending moment. Additional reinforcement of foam will also help to reduce its thickness to a size greater than depth of glue penetration from both sides.

Research procedures, described above led to exploration of most important aspects of examining joints between aluminum foams and sheet metal. Chosen methodology, as well as equipment were proper, what led to obtaining precise and explicit results.

Acknowledgement

The article was elaborated within the NCBiR project No. PBS1/A5/6/2012 under the title "Composite metal foam - heat treating, cutting, joining".

References

- [1] Grabian J.: Metalowe piany kompozytowe w przemyśle okrętowym. Szczecin 2012
- [2] Ashby M.F., Evans A.G., Fleck N.A., Gibson L.J., Hutchinson J.W., Wadley H.N.G.: Metal Foams: A Design Guide. Butterworth-Heinemann 2000
- [3] Sedliaková N., Simančík F., Kováčik J., Minár P.: Joining of Aluminium Foams. *Metallschäume: Proc. of Symposium Metallschäume*, Bremen 3/1997
- [4] Bartolucci S.: Commercial application of aluminium honeycomb and foam in load bearing tubular structures. Massachusetts Institute of Technology, 9/2004 (thesis)
- [5] Degischer H. P., Kriszt B.: Handbook of cellular metals: production, processing, applications. Wiley-VCH Verlag GmbH, Weinheim 2002
- [6] Olurin O. B., Fleck N. A., Ashby M. F.: Joining of aluminium foams with fasteners and adhesives. *Journal of Materials and Science* 35, 2000, pp. 1079–1085
- [7] Burzer J., Bernard T., Bergmann H. W.: Joining of aluminium structures with aluminium foams. 1998 MRS Spring Meeting
- [8] Krajewski S., Nowacki J.: Preparation of Aluminium Foam Edges For Welding. *Advances in Materials Science*, 13, 3(37), September 2013, pp. 64–75
- [9] Nowacki J., Grabian J., Krajewski S.: Problemy lutowania pian aluminiowych. *Przegląd Spawalnictwa*, 1, 2014, pp. 7–12
- [10] Panowicz R., Kołodziejczyk D., Sybilski K., Barnat W., Niezgoda T.: Analiza numeryczna dynamicznego oddziaływania fali ciśnienia na złożoną strukturę panelu energochłonnego. *Przegląd Mechaniczny*, 11, 2012, pp. 40–45
- [11] Kłasztorny M., Małachowski J., Dziewulski P., Nycz D., Gotowicki P.: Badania eksperymentalne i modelowanie piany aluminiowej ALPORAS. *Modelowanie inżynierskie*, 42, 2012, pp. 97–112