

## APPLICATION OF THERMO-BIMATERIAL EFFECT IN DESIGNING OF SNAP-FIT JOINTS

Snap-fit connections have been used for many years in various fields of technology and everyday objects. They often have complex shapes, which is allowed by the processing technology of the polymers from which they are made, but they are not designed to carry loads. Changing the material to a metal or fiber composite allows these types of joints to be used as replacements for rivets or screws, but there are problems with the closing technique – an increase in closing force due to the large Young's modulus of these materials relative to polymers without reinforcement. One of the methods to solve this problem may be the use of a thermo-bimetallic effect consisting in heating both or one of the connection parts to the appropriate temperature. This kind of treatment results in deflection of the beam of the clip (Fig. 1), followed by assembly with zero force or less in relation to the case without heating.

The paper presents the results of numerical simulations for the connection in which the beam of the clip consisted of two materials: (1) a fiber composite designed to carry loads, (2) thin metal layer tied with the composite and designed to create a thermo-bimetallic effect. In the case of this solution, the main parameter is the difference in coefficients of linear thermal expansion of both materials.

The paper presents results for two cases of connection work: closing and opening. The calculations were carried out in the Abaqus/Standard solver using thermal-displacement steps.

*Keywords:* snap-fit joints, numerical simulation, bi-material

### 1. Introduction

Snap-fit connections are mainly used in parts made of polymers, eg electronic equipment casings, car cockpit elements or snap fasteners in backpacks and bags. In contrast to traditional connections: adhesive [1-9], clinch [10-12], welded [1-2,10,13], riveted [6,10,14], and interlocking [15], they do not carry significant loads. In order to increase their strength and thus introduce them as an alternative to traditional joints, it is necessary to change the material from which they are currently made for fiber composites. Fiber composites in the form of prepregs, as well as polymers, allow for high possibility of shaping, but the technology is more complex. Snap-fit connections have two main operating parameters, these are the values of the closing and opening force and their ratio. Like the conventional connections, they are also subjected to uniaxial tensile test. During their design, the closing force is intended to be relatively low. The authors at work [16] applied an optimization algorithm, which allowed to increase the opening force by 150% in relation to the reference geometry. In [17] the authors draw attention to the phenomenon of dimensional inaccuracies and hence the need to design clips in order to obtain the same closing force. If there is too much interference, the clip base may be damaged, while excessive clearance can cause connection opening. For work-

ers employed on assembly lines, ergonomics is also important in designing of snap-fit connections [18]. The value of closing force and the guarantee that the connection has been properly assembled is important. A suitable ratio of the opening to the closing force can be achieved by choosing a composite layer arrangement or the shape of a clip's interface surface. When using a convex surface, the opening force can be increased by 45% [19]. In the case of repairs or inspections of devices assembled using the snap-fit technique, there is a problem with disassembly of joined parts. A high value of the opening force often causes damage of the clips, and their reassembly becomes impossible.

Therefore, in [20-22] the authors proposed application of shape memory material based on the commercial product "Veriflex" as the core of the clip and the external part made on a 3D printer based on the material FullCure 835 or ABS. However, these are prototype solutions and difficult to apply to large structures in which there are dozens of connections.

The effort should be carried out in order to get novel solution so-called active clip beam, based on currently used carbon fiber prepregs. Therefore, the following paper presents the new concept of using bi-material in the construction of the clip and elevated temperature during assembly, in order to reduce the closing force or make easier disassembly.

\* LUBLIN UNIVERSITY OF TECHNOLOGY, DEPARTMENT OF SOLID MECHANICS, FACULTY OF CIVIL ENGINEERING AND ARCHITECTURE, 40 NADBYSZYCKA STR., 20-618 LUBLIN, POLAND

# Corresponding author: t.sadowski@pollub.pl

### 2. Thermo bi-material effect

Bimetallic elements have been used from the 18th century in such items as: watches, thermostats, thermometers, electronic devices. Their operation can be compared to shape memory materials, because after heating and cooling they return to their original shapes. Most often they have the shape of a beam or a spiral. Stresses and deflections of the bimetallic beam can be determined analytically as shown in [23]. However, these calculations relate to situations where both materials are isotropic and linearly elastic. The following paper presents the use of a bimaterial effect for such materials as steel and PMC (polymer matrix composite) using carbon fibers. In the case of a fiber composite, both mechanical and thermal properties, depend not only of the layer system direction, but also on reinforcements type: unidirectional fibers or fabrics with different weaves. Thermal properties for three different composites using: unidirectional fibers, satin fabric and plain fabric were determined in [24]. The dependence of thermal conductivity and specific heat was tested for temperatures ranging from 25°C to 200°C for two directions: along the fibers and along the thickness. Based on literature, the following material data for the carbon fiber composite and thin layer made of 0H18N9 steel were adopted in the simulations (Table 1).

TABLE 1

Thermal properties of the joint components

	Specific heat $C_p$ [J/kgK]	Thermal conductivity coefficient $\lambda$ [W/mK]	Thermal expansion coefficient $\alpha$ [ $10^{-6}$ ]
Composite	1000	3,5	4
Steel	500	15	16

The elastic – plastic model description was used for thin steel layer. The following data were adopted: Young’s modulus 194 GPa, Poisson’s ratio 0.3, yield strength 155 MPa, tensile strength 500 MPa, elongation at break (fracture strain) 45%.

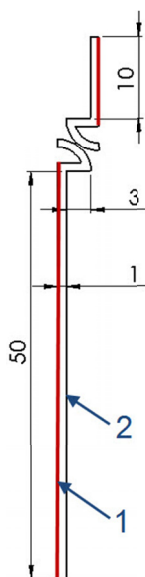

Fig. 1. Model dimensions



Fig. 2. FEM mesh



Fig. 3. Boundary conditions

To describe the composite material, a “lamina” elastic model was used (Table 2 and 3).

TABLE 2

Elastic properties of carbon composite

$E_1$ [GPa]	$E_2$ [GPa]	$\nu_{12}$ [-]	$G_{12}$ [GPa]
55.52	55.52	0.04	3.00

where:  $E_1$  – Young’s modulus along the fiber direction,  $E_2$  – Young’s modulus perpendicular to the fiber direction,  $\nu_{12}$  – in-plane Poisson ratio,  $G_{12}$  – in-plane shear modulus.

TABLE 3

Strength properties of carbon composite

$X_t = X_c$ [MPa]	$Y_t = Y_c$ [MPa]	$S$ [MPa]
828.09	828.09	105.41

where:  $X_t$  – tensile strength along the fiber direction,  $X_c$  – compressive strength along the fiber direction,  $Y_t$  – tensile strength perpendicular to the fiber direction,  $Y_c$  – compressive strength perpendicular to the fiber direction,  $S$  – shear strength.

### 3. The use of thermo bi-material effect in snap-fit model design

During designing of snap-fit connection with using thermo bi-material effect, two cases should be considered after heating:

- full opening of the connection,
- partial opening of the connection.

In the first case, the beam of the clip undergoes such a large displacement that their heads pass without contact during closing the connection. A similar case can be observed in [17]. The closing force will be zero in this case. However, such a large displacement is not always possible, due to design constraints regarding the beam length. Therefore, the second case was considered in this work, when only partial opening of the connection takes place. In this case, the clip heads are in contact during clos-

ing, however, due to the partial deflection, the force required to close the connection is less than when using a single material.

The dimensions of the analyzed clip are shown in Fig. 1. The red line indicates thin steel layer. The model was made of S4RT element types in the amount of 18900, the global dimension of the element was 0.2 mm. The image of the finite element mesh is shown in Fig. 2. The base of bottom part was encastre, and the base of upper part could only move along the “y” axis when closing or opening the connection (Fig. 3). The simulations assumed a zero stress state with respect to the temperature of 20°C.

In order to choose the appropriate ratio of the thickness of two materials (metal foil and carbon composite), a 50 mm long beam clip was simulated with encastre base. In Fig. 4, the maximum displacement is marked on the vertical axis, and on the horizontal axis the percentage of stainless steel in the beam thickness is marked. The total thickness of the beam was 1 mm. The simulations were carried out at three temperatures of 40°C, 60°C and 80°C. The maximum values were obtained for a ratio of 30% stainless steel and 70% carbon composite.

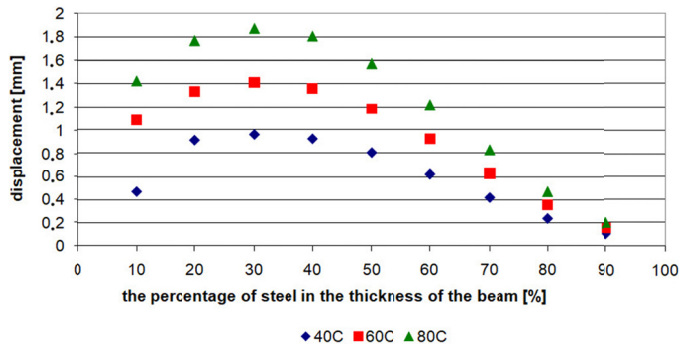

Fig. 4. Displacement graphs for various clip beam designs

However, apart from the favorable increase in deflection, it is also necessary to take into account the increase of the joint weight, therefore in further simulations the ratio of 10% stainless steel and 90% of carbon composite was used.

4. Simulation results

During designing of the snap-fit connections, the relationship between opening and closing force is very important. This ratio is called efficiency parameter of the joint and should be as high as possible. It would be best, to bend one or both of the clip beams and assemble them with zero force, but usually this is not possible, as the clips have inside the structure to which there is no access during closing. Another solution may consist in constructing mechanisms for deflecting beams during assembly or disassembly, but with a large number of such connections in the structure, it could be too expensive or even impossible to make. A parameter, that is independent on whether the structure is closed or open, is the temperature.

In this paper, the influence of temperature changes on the beam deflection, and thus closing and opening forces was

analyzed. Numerical calculations were carried out for seven temperatures from 20°C to 80°C with increments of 10°C. Temperature of 20°C was treated as the reference.

4.1. Connections closing

The process of connections closing took place in two steps. First, the beams of the clips were heated to a certain temperature and in the next step assembled. The assembly was carried out by a displacement for the upper part of the connection, which is usually provided by the cover. The key parameter associated with contact is the friction coefficient, which value was 0.1. Fig. 5 shows the force – displacement graphs. As the temperature increases, the force decreases because the clip heads are tilted. Taking into account the temperature of 20°C and a maximum of 80°C, a decrease of the mounting force was about 36% compared to reference force. The values shown in the graphs refer to 1 meter of the connection length. For temperatures from 30°C to 80°C, the initial force is zero, which is due to the fact that after a certain time the heads of the clips come into contact.

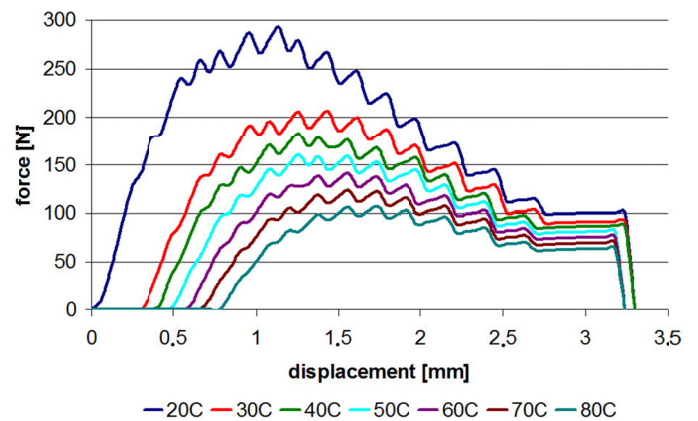

Fig. 5. Force – displacement graphs for connections closing

4.2. Connections opening

The opening process also took place in two steps: heating and tensile. If nothing limits the displacement of the beams, they will be deflected under the influence of operation at elevated temperature. How big loss of strength will happen then, we can observe in Fig. 6. This is obviously a disadvantage, and the solution to this problem will be presented in the next section.

Figure 7 shows, how the head of the clip being displaced after the heating process. The maximum value for 80°C is 1.6 mm.

For the reference connection, it is also necessary to analyze the value of the material effort. For lamina-type material, the Tsai-Hill criterion was used.

$$\frac{\sigma_{11}^2}{X_1^2} - \frac{\sigma_{11}\sigma_{22}}{X_1^2} + \frac{\sigma_{22}^2}{X_2^2} + \frac{\tau_{12}^2}{S^2} = 1$$

where:

$\sigma_{11}$  – normal stresses in the first direction,

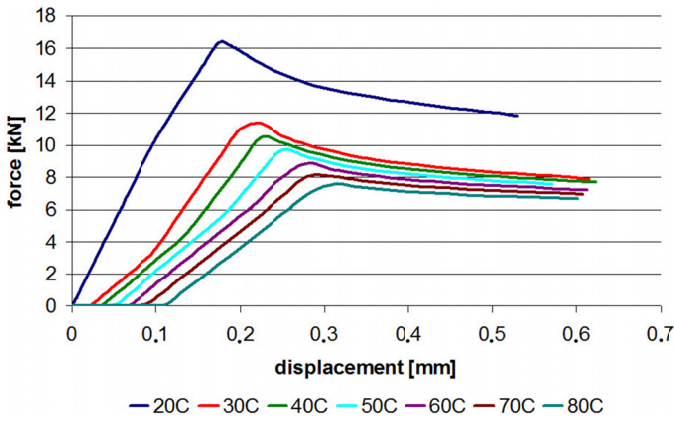

Fig. 6. Force – displacement graphs for connections opening

$\sigma_{22}$  – normal stresses in the second direction,  
 $\tau_{12}$  – shear stresses,  
 $X_1$  – tensile strength in the first direction,  
 $X_2$  – tensile strength in the second direction,  
 $S$  – shear strength.

If the stress components in the element satisfy the Tsai-Hill criterion, then the element is completely efforted.

Figure 8a shows the material effort for the reference temperature, which is approximately 20.5%. The situation is different for stainless steel layer, in this case the yield point of the material is exceeded (Figs 8b, 8c), thus opening of the connection will cause permanent damage.

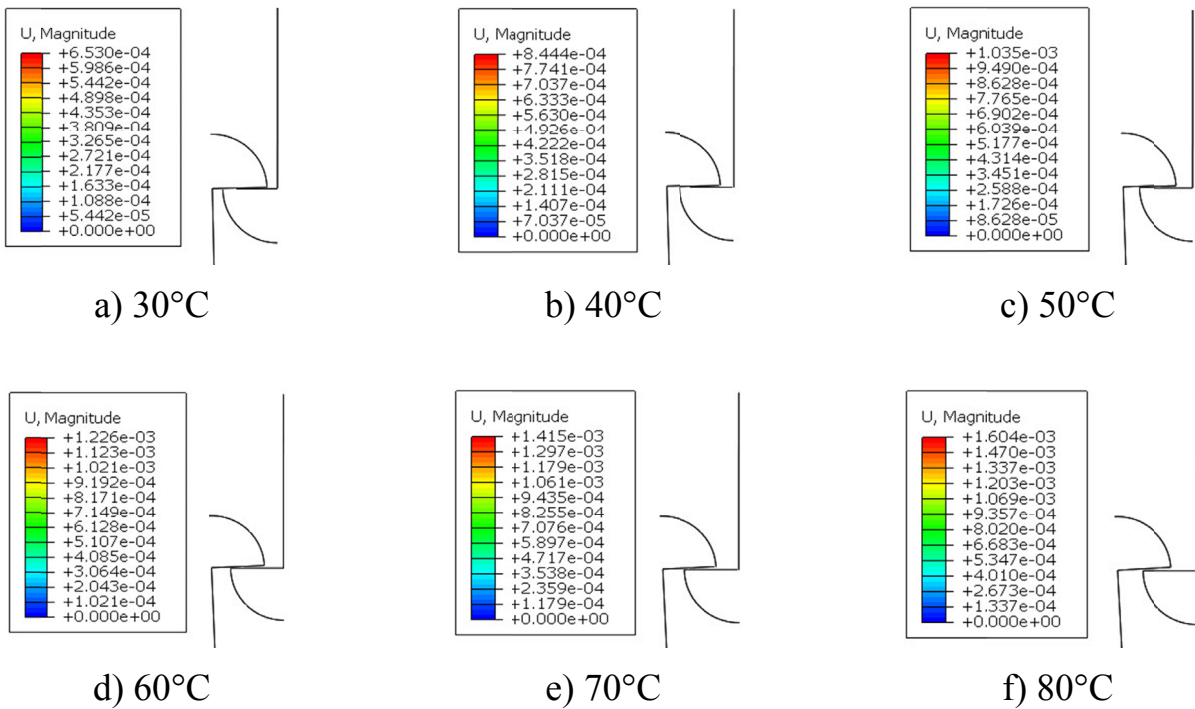

Fig. 7. Initial deflections of the clip heads [m]

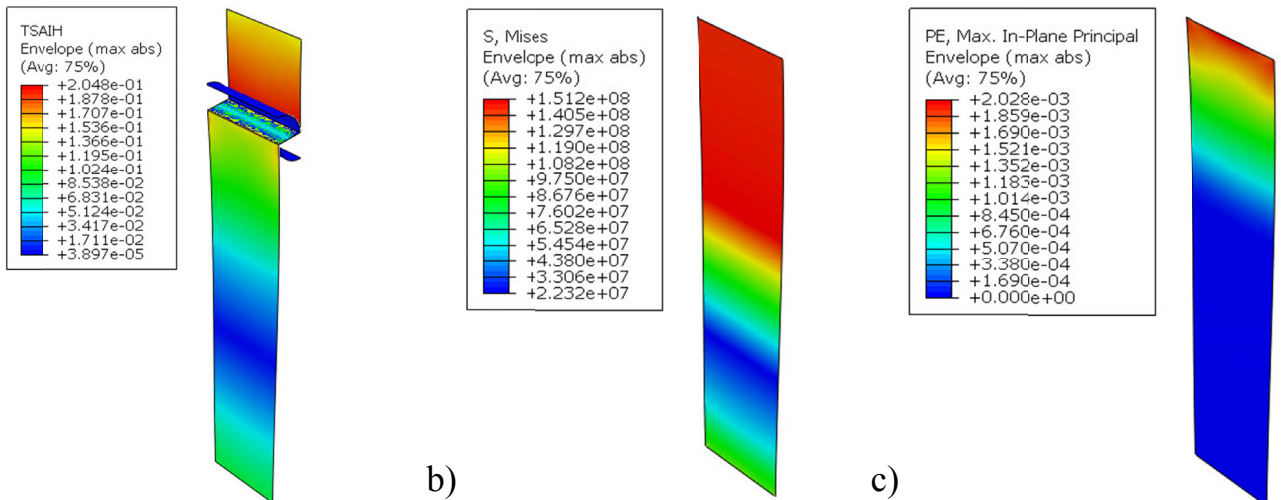

Fig. 8. Material effort for temperature of 20°C: a) Tsai-Hill criterion for composite, b) Mises stresses for stainless steel foil [Pa], c) plastic strains in stainless steel foil

### 4.3. Opening of modified connections

The previous paragraph describes the phenomenon of reducing of the opening force when heating the connection. In most cases it is disadvantageous and in order to counteract it, some modifications should be introduced. In the analyzed models, two modifications were made compared to previous models:

- a preliminary prestressing force was introduced,
- the coefficient of friction increased from 0.1 to 0.2.

The aim was to achieve the effect of zero displacement of the clip head for the entire temperature range during heating.

It is not difficult to achieve an increase in the friction coefficient. The composite may be subjected to blasting (shot blasting or sandblasting).

Prestressing is more difficult to obtain, because it requires interference in the whole structure. Prestressing can be caused by the introduction of a gasket which, when compressed in the assembly process, acts on the cover and thus on the clip's beam [14]. Another solution may be the reaction of the cover on the clip beams, as shown in Fig. 9. In this case, the lengths of the clip beams are made in the negative tolerance. This results in the cover acting as a spring and stretching the connections. The low tensile force and increased friction results in the braking of the clip heads displacement during operation at elevated temperature.

In the analyzed cases, the simulations were carried out in three steps:

- prestressing of the connection with a force of 2000N/m,
- connection heating,
- connection tensile test.

Figure 10 shows the force-displacement graphs for the analyzed cases together with a reference graph for a temperature of 20°C and 0.1 of friction coefficient. The given forces refer to a unit connection length of 1 m. In the analyzed models, the increase in temperature also causes a decrease in the opening force, however, even at the value of 80°C, a force higher by 32% compared to the reference connection was obtained. Thus,

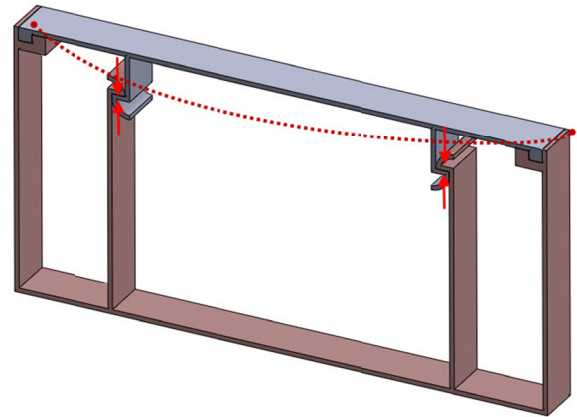

Fig. 9. Prestressing of clip beams caused by cover reaction

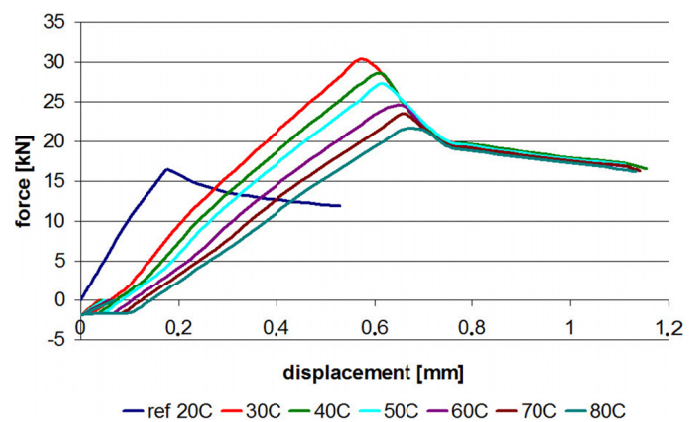

Fig. 10. Force – displacement graphs for modified models

the introduced modifications had a beneficial effect on the connections work.

It is also necessary to analyze the value of material effort at each stage, i.e. after the compression process, after heating and for the maximum opening force. Figure 11 shows the material effort for a temperature of 80°C.

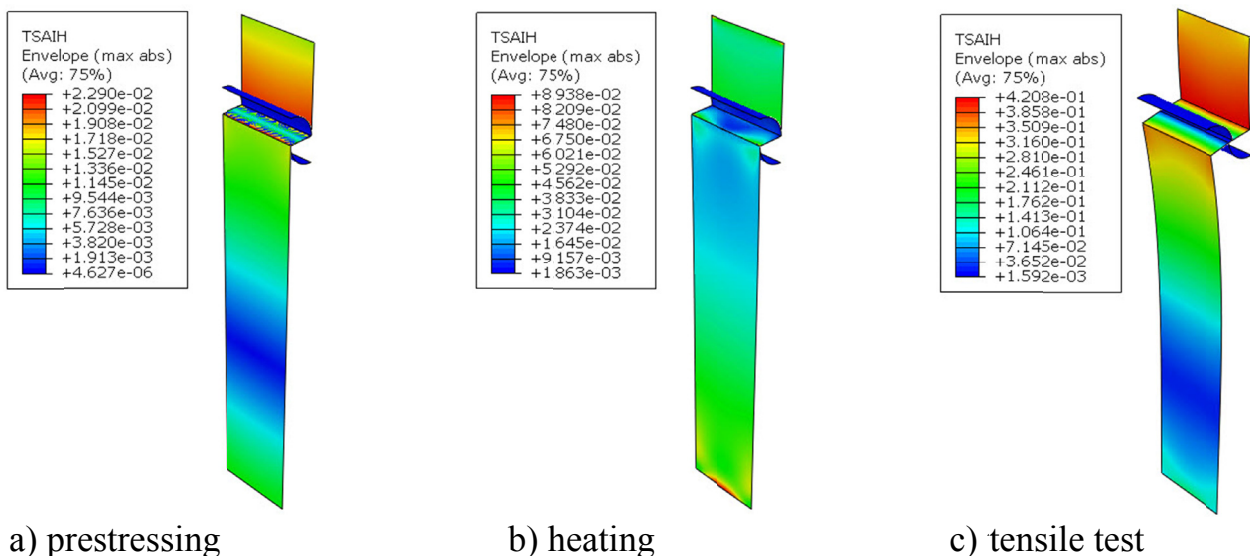

Fig. 11. Tsai – Hill criterion for 80°C operating temperature

As a result of the connection prestressing, the effort is only 2.3% (Fig. 11a). After heating, the effort increases, but only in the place of encastre, while in the head of the clip it drops to the value in the range of 1% (Fig. 11b). During tensile test, for maximum force, the composite will not be damaged, the effort is at the level of 42% (Fig. 11c).

## 5. Conclusions

The paper presents the new concept of construction of snap-fit connections using bi-material and elevated temperature during assembly. The following conclusions arise from the numerical investigations:

- during connections closing, the force decreases to approximately 36% of the reference value, taking into account the temperature rise to 80°C,
- during the tensile test of connection heated to 80°C, the force drops by approximately 53% in relation to the reference temperature, thus it is a negative phenomenon,
- in order that the beam of the clip will not be moved after heating and in the closed state, there must be a prestressing force of the connection originating e.g. from the action of the cover. In addition the working surfaces should have the highest friction coefficient,
- the effort of the composite material during the opening for the reference temperature is about 20.5%, and the Misses stresses in the layer of steel foil exceed the yield strength. Thus, there is a reserve of strength in the composite material, allowing to reduce its thickness and to increase the thickness of the metal foil, which (Fig. 4) could have a positive effect on increasing of beam deflection during heating.

The presented topic will be developed to include damage mechanisms during multiple closing and opening cycles of the joint. Different damage concepts presented e.g. in [25-34] can be used to extend theory of the snap-fit joints having the thermobimaterial effect.

## Acknowledgement

Financial support of the National Centre for Research and Development (Poland) – Project “Block Structures – Mechanical joining innovations to replace conventional fasteners in aerostructures”, contract No INNOLOT/I/5/NCBR/2013 is gratefully acknowledged.

This work was financially supported by Ministry of Science and Higher Education (Poland) within the statutory research number S/20/2018.

## REFERENCES

- [1] T. Sadowski, P. Golewski, M. Kneć, *Comp. Struct.* **112**, 66-77 (2014).
- [2] T. Sadowski, M. Kneć, P. Golewski, *J. Adhesion* **90**, 346-364 (2014).
- [3] L.F.M. da Silva, P.J.C. das Neves, R.D. Adams, J.K. Spelt, *Int. J. Adhes. & Adhes* **29**, 319-330 (2009).
- [4] L.F.M. da Silva, P.J.C. das Neves, R.D. Adams, J.K. Spelt, *Int. J. Adhes. & Adhes* **29**, 331-341 (2009).
- [5] A. Pirondi, F. Moroni, in *Advanced Structured Materials* **6**, 109-147, Springer 2011, L.F.M. da Silva, A. Pirondi, A. Öschner (Eds).
- [6] P. Golewski, T. Sadowski, *Int. J. Adhesion and Adhesives* **77**, 174-182 (2017).
- [7] L.F.M. da Silva, R.J.C. Carbas, G.W. Critchlow, M.A.V. Figueiredo, K. Brown, *Int. J. Adhesion and Adhesives* **29**, 621-632 (2009).
- [9] T. Sadowski, M. Nowicki, P. Golewski, *Int. J. Adhesion and Adhesives* **89**, 72-81 (2019).
- [10] A. Pirondi, F. Monori, *J. Adhes. Sci. Technol.* **23**, 1547-1574 (2009).
- [11] T. Balawender, T. Sadowski, *J. Adhes. Sci. Technol.* **25**, 2391-2407 (2011).
- [12] T. Balawender, T. Sadowski, P. Golewski, *Comput. Mater. Sci.* **64**, 270-272 (2012).
- [13] R.D.S.G. Campilho, A.M.G. Pinto, M.D. Banea, L.F.M. da Silva, *Int. J. Adhesion and Adhesives* **27**, 86-95 (2012).
- [14] T. Sadowski, P. Golewski, *Arch. Metall. Mat.* **58**, 581-587 (2013).
- [15] T. Sadowski, P. Golewski, V. Radoiu, *Solid State Phenomena*, **254**, 1-7 (2016).
- [16] M. Roos, B. Horn, S. Gramlich, S. Ulbrich, H. Kloberdanz, *Procedia CIRP* **50**, 123-128 (2016).
- [17] Y.H. Chen, C.C. Lan, *Mech. Machine Theory* **55**, 34-50 (2012).
- [18] L. Rusli, A. Luscher, C. Sommerich, *Int. J. Industrial Ergonomics* **40**, 618-628, (2010).
- [19] P. Golewski, T. Sadowski, *IOP Conf. Series: Materials Science and Engineering* **416** (2018) 012061.
- [20] H. Li, K. Jin, B. He, Y. Chen, *CIRP Annals - Manufacturing Technology* **61**, 31-34 (2012).
- [21] B. He, H. Li, K. Jin, *Mater. Design* **47**, 539-550 (2013).
- [22] J. Carrell, D. Tate, S. Wang, H.C. Hang, *J. Cleaner Production* **19**, 2066-2074 (2011).
- [23] D. Ramos, J. Mertens, M. Calleja, J. Tamaro, *Sensors* **7**, 1757-1765 (2007).
- [24] R. Joven, R. Das, A. Ahmed, P. Roozbehjavan, B. Minaie, *Thermal properties of carbon fiber-epoxy composites with different fabric weaves*, Conference: Conference: SAMPE International Symposium Proceedings, At Charleston, SC, (2012)
- [25] H. Dębski, T. Sadowski, *Comput. Mater. Sci.* **83**, 403-411 (2014).
- [26] G. Golewski, T. Sadowski, *Constr. Build. Mater.* **51**, 207-214 (2014).
- [27] L. Marsavina, E. Linul, D.M. Constantinescu, D. Apostol, T. Voiconi, T. Sadowski, *Eng. Fract. Mech.* **129**, 54-66 (2014).
- [28] J. Gajewski, T. Sadowski, *Comput. Mater. Sci.* **82**, 114-117 (2014).
- [29] T. Sadowski, A. Neubrand, *Int. J. Fract.* **127**, L135-L140 (2004).
- [30] T. Sadowski, B. Pankowski, *Comp. Struct.* **143**, 388-394 (2016).
- [31] T. Sadowski, *Comput. Mater. Sci.* **64**, 209-211 (2012).
- [32] V. Burlayenko, H. Altenbach, T. Sadowski, D.S. Dmitrova, *Comput. Mater. Sci.* **116**, 11-21 (2016).
- [33] T. Sadowski, S. Samborski, *Comput. mater. Sci.* **43**, 75-81 (2008).
- [34] T. Sadowski, E. Postek, C. Denis, *Comput. Mater. Sci.* **39**, 230-236 (2007).