

ORIGINAL ARTICLE

The influence of mining activities on the Church of St. Cross in Bytom–Miechowice

Tomasz Lipecki^{1*}, Hanna Ligarska¹ and Małgorzata Zawadzka¹

¹Department of Mining Areas Protection, Geoinformatics and Mining Surveying, Faculty of Mining Surveying and Environmental Engineering, AGH University of Science and Technology, Adam Mickiewicz Av. 30, 30-059, Cracow, Poland

*lipecki@agh.edu.pl

Abstract

The paper presents an analysis of the influence of multiannual coal exploitation on the church situated in Bytom–Miechowice. The objects has been monitored for many years by classic measurement methods as well as by the laser scanner. The measurements performed in 2015 allowed for a comprehensive analysis of the geometrical state of the construction. Laser scanning method enabled creating a model of the current state of the building and comparing with theoretical dimensions and dependents. The article focuses on the specific of conducting spatial analysis, which must take into account not only geometry of the construction, but also the kinematics of terrain deformations as well.

Key words: structures deformations, the impact of mining, construction monitoring, spatial analysis, laser scanning, 3D modeling

1 Introduction

Coal mining is limited in Poland and is mainly implemented from the longwall mining system with collapse, resulting in specific effects on the surface (Budryk and Knothe, 1956; Kaszowska, 2007). For this reason, exploitation in built-up areas is restricted so that the deformation field does not cause the degradation of technical and construction infrastructure. Unfortunately, it is not always possible to exclude from the exploitation of such areas. An example of exploitation under built-up areas is coal mining under the districts of Bytom (Ledwoń, 1983; Kwiatek, 1997; Popiołek, 2009; Kawulok, 2010). The objects that are affected by the influence of mining exploitation are lowered and tilted, and sometimes under the influence of excessive loads carried by the structure, they suffer damage in the form of cracks. Deformation of the terrain is usually continuous, described as Terrain Categories (0 to V), characterized primarily by the size of horizontal changes in length (strains) and surfaces slope. There are many publications on geodetic surveys on the impact of mining on buildings, for example: Popiołek and Hejmanowski (2008), Hejmanowski and

Kwinta (2010), Jóźwik and Jaśkowski (2011), Ostrowski (2015), Niedojadło et al. (2016). One of the objects that was exposed to the effects of mining and deformation was the church St. Cross in Bytom–Miechowice (Kawulok et al., 2015; Słowik et al., 2015), which is located in the Silesian province. The article also presents an assessment of these deformations, based on the cyclical survey conducted by mine survey and article authors. It presents a 3D modeling technique based on laser scanning which allows for a comprehensive assessment of the condition of the object (Ligarska and Zawadzka, 2016).

2 Description of the church of St. Cross in Bytom–Miechowice

The church of St. Cross (Fig. 1) was built in neo-gothic style in the 1860s on the cross plan in the western part of the city of Bytom.

The building is symmetric along longitudinal axis, by East–West direction. Brick–build external walls, internal pillars securing a higher central aisle 13 m high and two lower, 11 m high,

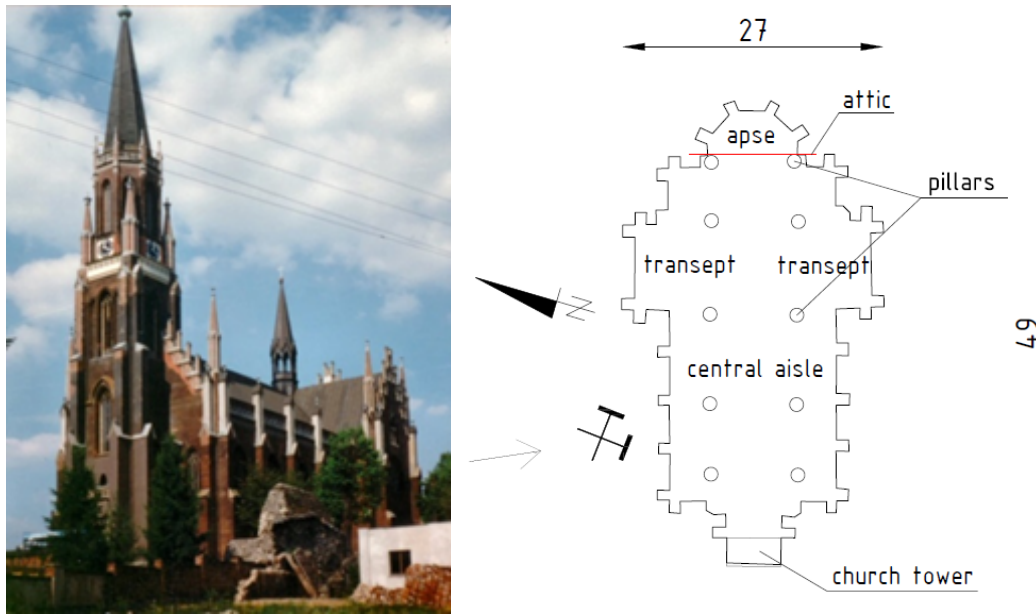

Figure 1. Church and its horizontal projection

constitute its basic structural system. In the western part of the church above the main entrance is dominated by a 60 m high church tower. At the place where the chapel and the apse are connected geometrically, an attic has been erected above the vaulting support structure, which construction has been severely deviated from the vertical by the multi-annual impact of mining. Detailed characteristic of this object was presented in the referring article (Słowik et al., 2015).

3 Deformation forecast

In the Mechowice district the coal deposits cover about 180 m below the surface and the layer above it is primarily a trilum with a 40 m layer of marl and 80 m layer of limestone. The quarter has a thickness of about 30 m with the advantage of clay loam. Due to the intense exploitation of hard coal under the city for several decades, compared with 1949 data, the center of Bytom was 6 meters away and the Miechowice district was up to 16 meters.

Exploitation, which significantly affected the damage to the church structure, took place in 2003–2005 (directly under the building on February 2004 – mining panel 510 – upper layer). The exploitation, whose impact on the church is described in the article below, began in July 2013 (directly under the church at June / July 2014) in the south-east, with the walls 30a and 31a, mining panel 510. Depth of the exploitation was 810 m with a panel thickness of 2.4 m, which in the church area was reduced to 2.0 m. Additionally there are introduced rigors of operating speed – up to 2.5 m/day, no more than 50 m per month.

In order to know the potential impact of the operation on the church building, a forecast of deformation of the site subject to negative impacts of the operation of the walls 30a and 31a located directly under the site was commissioned. The forecast includes a map of the fallen and degraded isolines to be revealed in IV 2014 – IV 2015. Geodetic measurements were also performed during the extraction, and a map of existing deformations was made on the basis of the results (Lipecki, 2009).

In order to verify the predicted deformation, a comprehensive study was developed (Fig. 2), which included both maps in the previous section of the ArcMap program, so that the predicted accuracy of the forecast could be analyzed with the actual

situation.

Under the church building, the expected falls were in the range of $0.9 \div 1.4$ m, rising to the north-east (Fig. 2). The compressive deformation should not exceed 11 mm/m. By comparing the measured values, it can be seen that subsidence roughly overlap with the forecasts and are contained in values of $1.0 \div 1.5$ m, rising in the same directions. In contrast, the maximum subsidence of the measured benchmarks, described in subsection 4.2, exceeds the predicted values and reaches 1.6 m. The deformations at the site beneath the church are in the II category of the mining area (strains 1.5 to 3.0 mm/m), and therefore are much smaller than the predicted (IV and V category – strains above 6 mm/m).

4 Developing the results of classical geodetic measurements

4.1 GNSS measurement

As of January 2014, the GNSS measurements (Lipecki, 2009, 2011) were performed at 3 points (Fig. 3a), near the church, monthly or every 2 months. From the third period (from 30.05.2014), the displacement of the points became different (the moment of the front of the wall under the object) in both the direction and the displacement value. The largest periodic displacement (per two months) was at point 3006. The change in the position of all points relative to the initial measurement was up to approximately 10–12 cm (Dec. 2014), decreasing successively in the following months. The overall tendency to change the position of the points has remained the same: north, then south-east and finally north again, aiming for a starting position. This was due to the development of the settlement basin and the location of the fronts of the walls in relation to the monitored points.

4.2 Subsidence measurement

In the area of the church periodic measurements of land plots were carried out at different frequencies. At the moment of passing the front of the exploitation wall under the object and the occurrence of the highest influence, the leveling was done

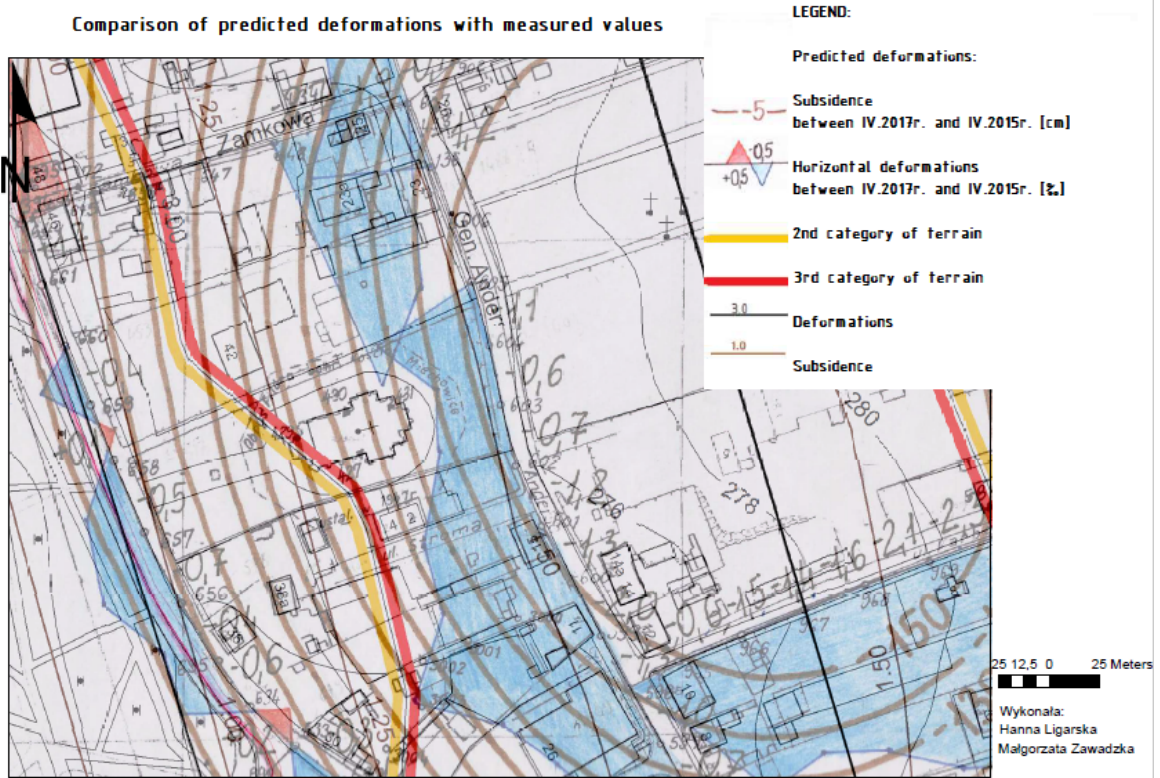

Figure 2. Comparison of predicted deformations with measured values [Own elaboration based on maps received from mine]

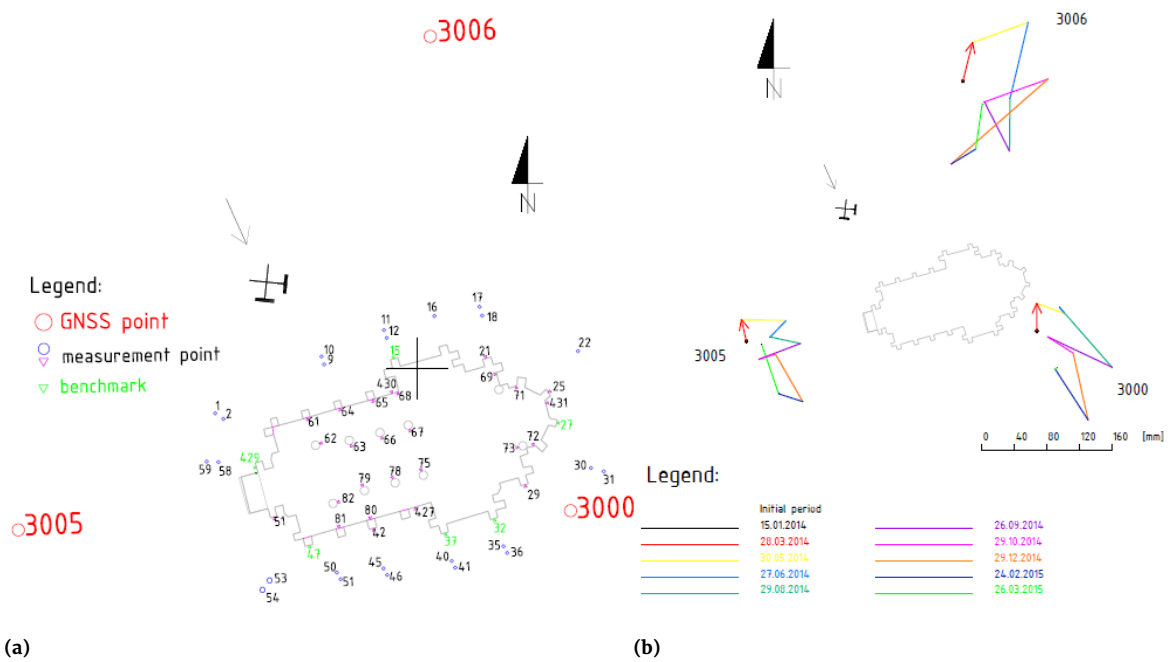

Figure 3. Location of test points (a) and displacement of GNSS points (b)

Summary of benchmarks subsidence from 01.2014 to 04.2015

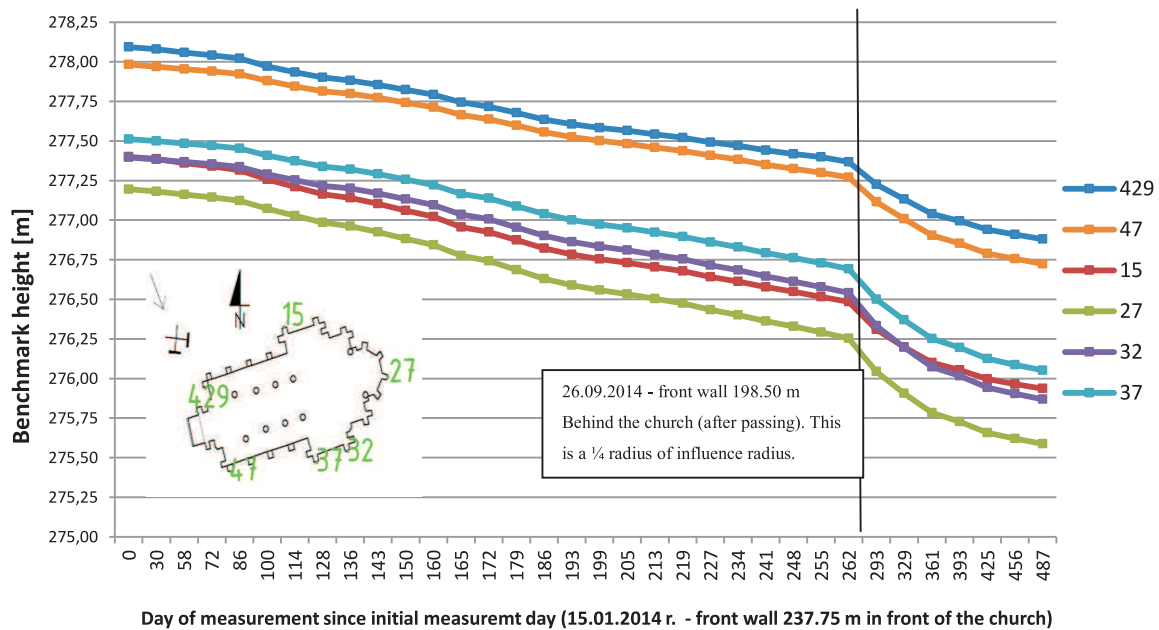

Figure 4. Summary of benchmarks subsidence from 01.2014 to 04.2015

once a week (from May to November 2014).

In the initial period of running, all controlled elevation points were evenly distributed. After about 180 days (11.07.2014), when the operation was directly under the church, the values of the benchmarks were not homogeneous (the repertoire on the eastern side of the church settled more than on its western side). In analyzing the diagrams of the individual repairs (Fig. 4), it has been observed that approximately 260 days after the beginning of the operation there was a sudden decrease in elevation points (26.09.2014 when the front wall was about 200m behind the church after passing under the object) 0.3 m to $1.5 \div 2.0$ m. In the period from 23.05.2014 (the front of exploitation was 100 m behind the object from the north) to 26.09.2014 (front of exploitation was 200 m behind the object from the south) the most intense changes took place. Approximately 260 days after the start of measurements (September 2014), a clear break is visible on the graphs of each benchmark, indicating that the subsidence process has accelerated during this time. All repercussions decreased by at least 1.2 m. The repercussion number 27 decreased the most – the reduction value is 1.6 m, that is 0.4 m more than the repertoire value of 429. These points are located on two opposite sides of the church. Benchmark # 27 is located in the eastern part of the entrance, while benchmark # 429 is in the western part of the building. This means that the object does not settle evenly, but the direction of settling of the object is consistent with the depression trough system (Figure 2). Benchmarks 32, 37, 15 and 27 are located on the eastern side of the Church and they have reached the highest settlement values, which means a higher inclination of the church building toward E – NE.

4.3 Measurements of deformation

At the same time, linear measurements were performed with periodic measurements of the reductions, allowing for the de-

termination of relative length changes, "Horizontal deformations". The results of the measurements made available by the mines were made in 34 periods at different time intervals from 01.2014 to 03.2015. Below (Fig. 5), the maximum deformation values that occurred on the given data are shown. Measurement of deformation consisted in measuring the change of 33 distance between the repertoire (paving stones, repertoire on church walls and inside pillars). Initially, the measurement was done once a month, then twice a month, and since 19.05.2014, the measurement was done once a week because of the dynamic changes that required regular follow-up.

The first measurement (zero) took place on 14.05.2013, next year – 15.01.2014, at that time the wall was 238 meters north of the church. The facility was mostly stretched, especially its eastern side. During subsequent measurements, at the sections where the highest stretches were observed, this time leading to the highest compression rates, which reduced the impact of exploitation. As the exploitation approaches the front of the church, the northern part of the church (from the exploitation side) has higher compression than the remaining sections, even -0.93 mm/m (section 64–65).

The period from 14.08 to 29.08.2014 brought the greatest deformations for the construction of the church – at that time the tensile values measured on the sections located inside the building on its western side were up to $+2.47$ mm/m. It was the time when the exploitation was already under the facility and it was about 150 m on its south side. The observed phenomenon is not consistent with the theory of behavior of the building during the transition of the basin, because at this moment the object should be affected by compressive forces, resulting from the formation of the basin after the front of the exploitation. Impact on this result can be related to exploitation of the second wall (30a) which timing is not known by the authors. When analyzing the values of deformation in time when the wall was behind the church, an analogy to the initial

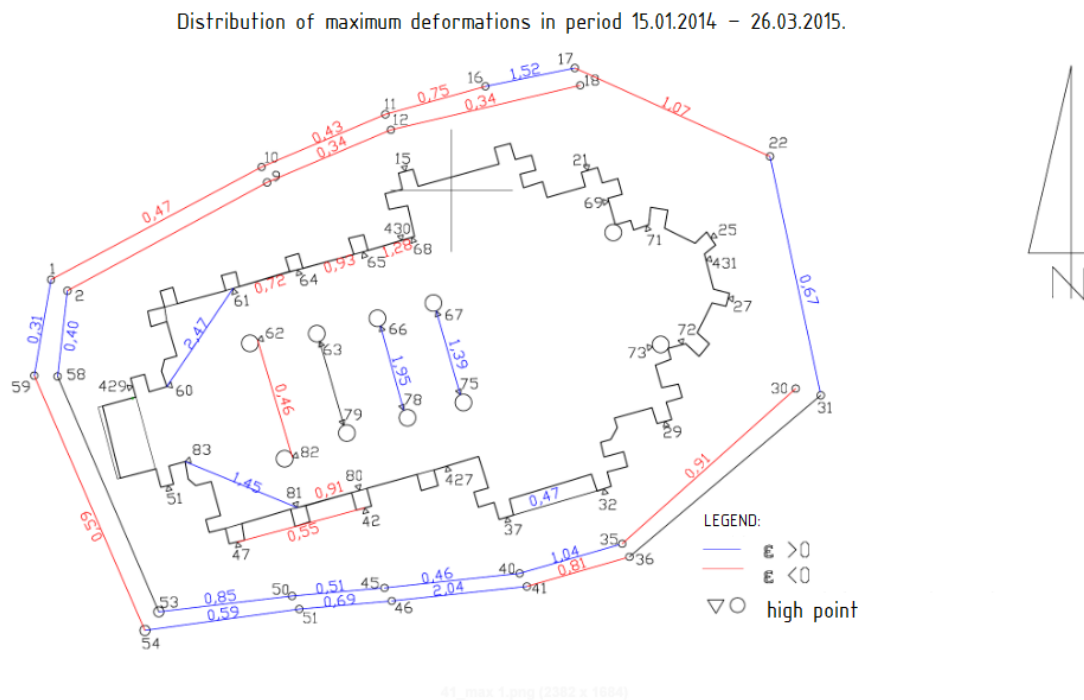

Figure 5. Distribution of maximum deformations in period 15.01.2014 – 26.03.2015

period can be noted. During this time, the highest values of compression were observed in the southern part of the church.

While analyzing the values of the deformations that have occurred since the beginning of exploitation, it can be seen that the stretches prevailed, and only in the last one (26.03.2015), these stretches were removed and finally transformed into compression. In the area of the object, the values of stretching occurred in the southern part of both the church and the pavement surrounding the church. The area in front of the church, on the north side, has been subjected to greater compression (Fig. 5), which corresponds to the location of the center of the depression trough (Fig. 2).

It turns out that the deformations occurring in the church area mostly consist of 0 and 1 terrain categories. The exception is the strain value at length 41–46 in period 9 and 60–61 in periods 27–29 (X–XII 2014) and do not exceed the second category of terrain – reaching a maximum of +2.47 mm/m. Comparing this to the deformation forecast described in point 3, they are more than four times less than the predicted maximum values.

5 Developing of results from laser scanner

The main part of the conducted deformation analysis of the building was the development of laser scanner measurement results (Lipecki, 2010), made in June 2015. Using a built-in 3D church model based on laser measurement data, an analysis of the geometry of the major structural elements of the building will be made and compared with the previous state-of-the-art geodetic surveys. Scanning of the object gives a lot of possibilities for its geometric analysis, based directly on the discrete (spot) model as well as the 3D surface model, created based on the fit of the so-called basic geometric bodies. This article presents an analysis of the verticality and other geometrical properties of the individual elements of the church structure.

Scanning was done by FARO equipment, total 28 stations, 14 posts outside and inside the object. Positions are shown in Figure 6. In the Faro Scene software, consecutive scans were combined based on the joint points that were placed in the course

of the measurement of the spheres and on the basis of planes and other characteristic points, allowing the same parts of the object to be uniquely identified on the two scans. The accuracy of the scans received was found to be satisfactory.

After removing unnecessary points and so-called “noise” in CloudCompare, point clouds containing only the outer and inner parts of the church were obtained (Fig. 7). The individual elements are then analyzed, among others: pillars, church steeple, attic, side walls, edges of window openings (Fig. 1 and 7).

Rhinoceros 5 (Fig. 8) was used for modeling church parts. Thanks to the possibilities it gives, analyzes of distances from the created theoretical design model (ideally vertical) and measurements were made, among others changes in the position of the pillars of the modeled transverse cross-sections. Based on the obtained results it was possible to determine the deflections and deformations of the individual elements. In order to analyze the scanned distance of the point cloud from the model correctly, the exported points forming the modeled fragment of the church must be precisely separated so that other parts of the church structure do not interfere with the analysis. For example, in the case of window shutters, you have to get rid of the stained glass and the wall surrounding the shutters. This requires removal of all outlying parts such as scanned sections of windows, various cornices, thresholds, etc. Below (Fig. 9), you will see the layout of all the modeled items on the church plan.

Because the actual layout of the church is not precisely orientated with the world, Rhinoceros decided to rotate the model so that the X axis corresponds to the EW direction and the Y axis to the SN direction, so that the readings correspond to the tilt of the main elements of the church (like the chancel, the main entrance).

The basis of the analysis was to compare the scanned point cloud to the theoretical, perfectly vertical model. Creating theoretical models consisted of making the lower contour of each structural element and pulling it vertically to the desired height. In this way reference models of attic, interior and exterior pil-

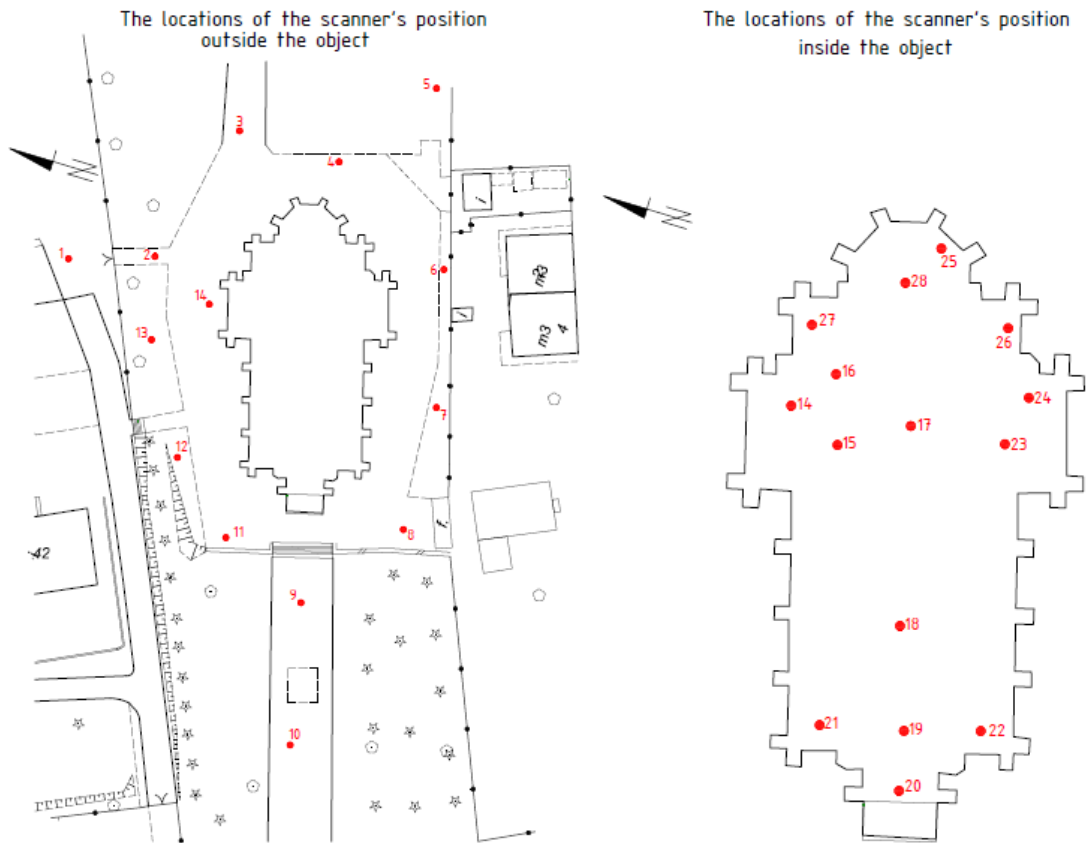

Figure 6. The locations of the scanner's position outside and inside the object

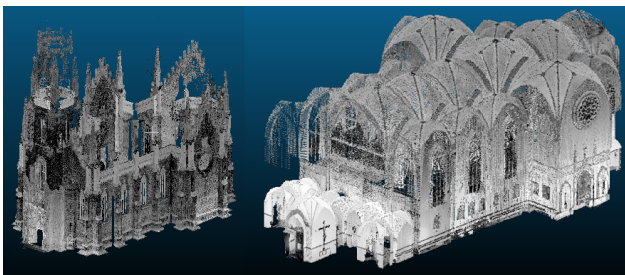

Figure 7. The view of the outer and inner part of the church – point cloud view

lars, church tower, side walls, shutters were created, and finally the 3D model was created as well (Fig. 8).

6 Analysis of results

Firstly, the analysis of the verticality of the inner pillars of the church began. It consisted in selecting points and creating a model to which the points from scanning were to be compared.

Rhinoceros software allows to determine the limit distance vectors of a given point from the reference model. For tested pillars, the value for the so-called the “good” point was taken 2.5 cm, and for the so-called “wrong” 10 cm. As a result of the analysis, three values are obtained: mean distance – the arithmetic mean of all points distances from the model, median distance – the center distance for the entire set of points and standard deviation – the distance distribution of the points from the model to the average distance. In the first place, the distance of the pillar points from the reference models (Fig. 10)



Figure 8. 3D model of the church of St. Cross in Bytom–Miechowice

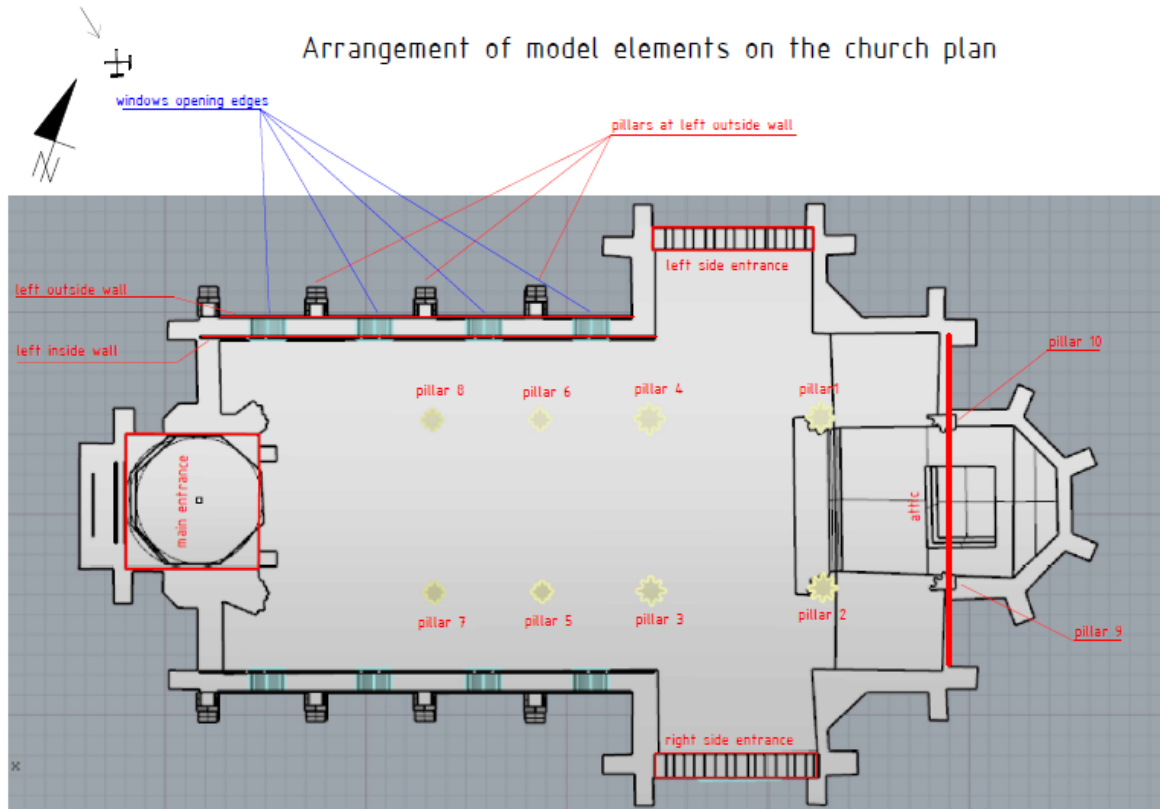

Figure 9. Arrangement of model elements on the church plan

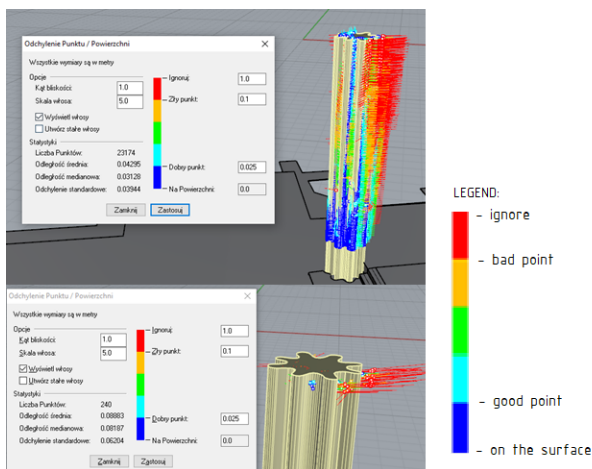

Figure 10. Declination of set points from model – pillar 1

Pillar	Avg dist. [m]
1	0.043
2	0.046
3	0.040
4	0.065
5	0.058
6	0.055
7	0.052
8	0.043
9	0.042
10	0.056

Table 1. Results of declination analysis of set points from model – whole pillar

was analyzed, which gave the results of average distance points from the models of about 4.5 cm (Tab. 1). It has been found that this analysis does not say much about the delimitation of the entire pillar, a further analysis was carried out which analyzed only the highest intersection of the given pillar. Values oscillated approximately around 10 cm (Tab. 1).

Because the analysis described above does not speak of the segmental values of declination of the entire pillar height, a detailed analysis of each pillar was performed, by modelling 5 intersections cut-off from the cloud point and reading the fit in each modelled profile of the circles (Fig. 11). Due to this analysis, the values, directions and indirect distortion of each pillar declinations were received (Fig. 12) The maximum declination of the pillars now stands at 29.0 ‰ (Tab. 3). Before the coal exploitation in 2014 it was 25.6 ‰ (Słowik et al., 2015) which

Pillar	Avg dist. [m]
1	0.088
2	0.099
3	0.101
4	0.115
5	0.103
6	0.093
7	0.098
8	0.076
9	0.065
10	0.080

Table 2. The results of the declination of the points of the highest profile points from the model – cross section 5

Table 3. Values of pillars declination from the vertical

Pillar	[g]	Inclination			Azimuth [g]	Total incl.* [mm]
		[%]	[‰]	[mm/m]		
1	1.8440	2.90	29.0	28.974	69.7926	289.7
2	1.4625	2.30	23.0	22.976	96.4309	229.8
3	1.4088	2.21	22.1	22.134	91.9235	221.3
4	1.8408	2.89	28.9	28.923	95.0748	289.2
5	1.3775	2.16	21.6	21.641	96.7875	216.4
6	1.6387	2.57	25.7	25.747	86.2799	257.5
7	1.5042	2.36	23.6	23.633	87.1489	236.3
8	1.4968	2.35	23.5	23.515	80.5419	235.2

* total inclination at 10 m

Table 4. The final inclination values

	[g]	Inclination			total [mm]	direction	Total height [m]
		[%]	[‰]	[mm/m]			
attic	2.661	4.18	41.8	41.818	1200	N-E	28.70
whole tower	1.7552	2.76	27.6	27.578	1028	N-E	37.28
upper part of the tower	2.0101	3.16	31.6	31.585	370	N-E	11.77

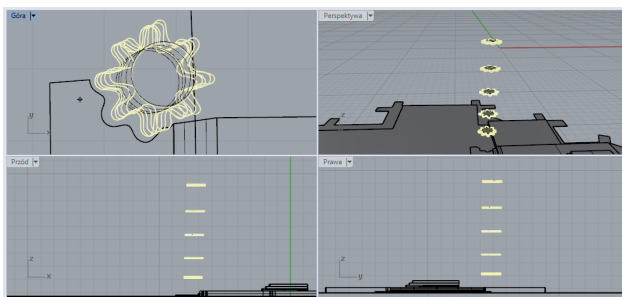
**Figure 11.** Example of modeled sections of pillars for analysis

means that as a result of the exploitation, the condition of the church's structural components continues to deteriorate.

The next element analyzed was the attic (Fig. 13), which due to earlier exploitation was significantly stressed (December 2004 – 38.2‰). Measurement carried out during the last exploitation showed that its declination raised to 44.4‰ in March 2013 and to 55.4‰ in November 2014 (Kawulok et al., 2015). Analysis conducted in the Rhinoceros program showed that in June 2015 the incidence of this element was 41.8‰ (Fig. 14, Tab. 4). This means that the slope of the terrain and consequently the inclination of the attic decreased after the end of exploitation.

Declination's linearity was also checked by reading the value of declination on levels lower than 1 m. On this basis, the coefficients of the linear regression equation were calculated. The coordinates in the Rhinoceros program did not differ by more than 1 cm from the expected values determined from the regression equation (Fig. 15), therefore it has been found that attic's declination is linear.

The analysis of the church tower's verticality was much more difficult as the lower parts of the tower were heavily built by other construction elements, so it was impossible to fit the solid into the cloud of points precisely. Therefore, the lower parts of the tower are represented by planes 1÷3 (Fig. 16), while the rest of the tower is already represented by solids. Delimitation of every single element was measured and summed. For lower parts delimitation was determined only in the east direction, while for the upper part it was possible to determine the centre coordinates of circles adjusted in blocks. Delimitation was calculated for the whole tower and separately for the upper and lower parts (Tab. 4) because of accuracy of adjustment.

Table 5. Declination of the side walls of the church in the longitudinal direction of the building

No.	Inclination/Declination				Direction of incl. [m]
	[g]	[%]	[‰]	[mm/m]	
HE 1-2	2.2684	3.56	35.6	35.647	N-E
HE 2-3	1.2824	2.01	20.1	20.147	N-E
HE 3-4	1.4304	2.25	22.5	22.472	N-E
HE 4-5	1.7696	2.78	27.8	27.804	N-E
HE 5-6	1.6573	2.60	26.0	26.038	N-E
VE 1	2.1682	3.41	34.1	34.072	N-E
VE 2	2.2765	3.58	35.8	35.775	N-E
VE 3	2.5473	4.00	40.0	40.034	N-E

HE – Inclination of the horizontal edges of the window openings

VE – Vertical declination of the edges of the outer pillars from the vertical

Declination was about 30‰.

The verticality of the side walls of the church, as expected, was not significantly altered in the transverse direction of the church (Fig. 17).

To determine the declination in longitudinal direction, declinations of window openings (Fig. 19) and the outer pillars (Fig. 18) were determined. The opening of the window openings was about 26‰, while the declination of the pillars was much higher and was 34 ÷ 40‰ (Tab. 5). Influence on such large pivoting of the pillars can have inaccurate fit in the model and complicated construction of the pillars (probable narrowing of the object up).

7 Summary

The aim of the article was to analyze the impact of mining operations conducted in 2014 on the church of St. Cross in Bytom – Miechowice. For this purpose, a number of analyzes have been presented, including the forecast of surface deformation, deformation measurements performed by classical methods and laser scanning of the church itself. This resulted in a description of the deformation of the area around the church as well as its individual structural parts. Significant supplement to the measurements and analyzes performed as standard were analyzes based on laser scanning. The declination values of structural elements have been obtained, as summarized in the

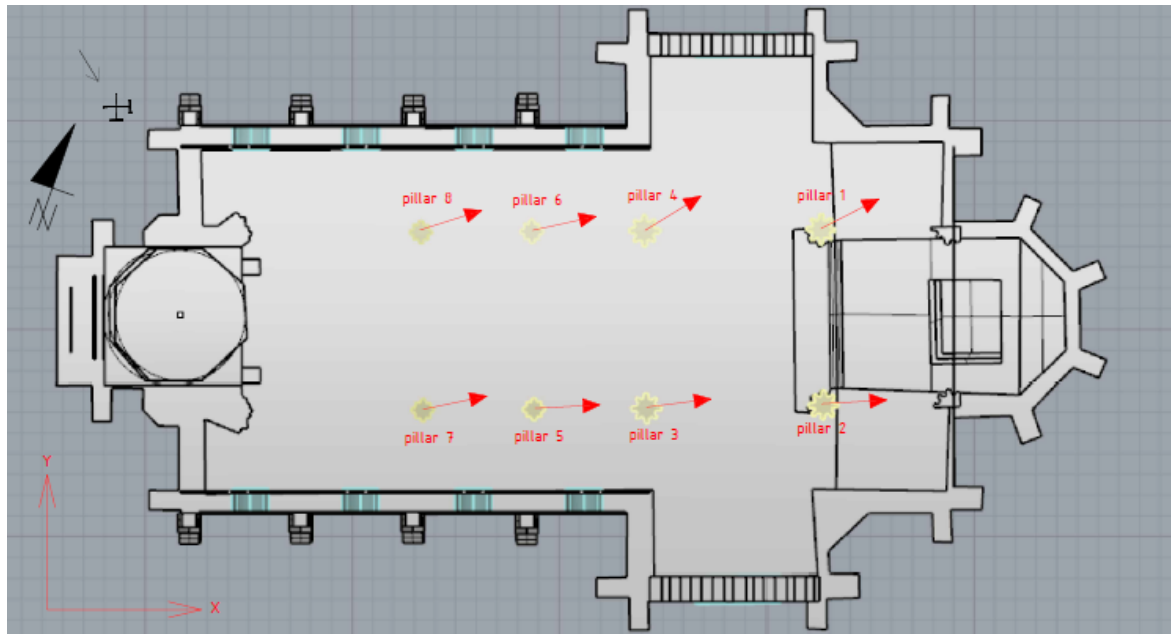

Figure 12. Direction of pillars declination in the church

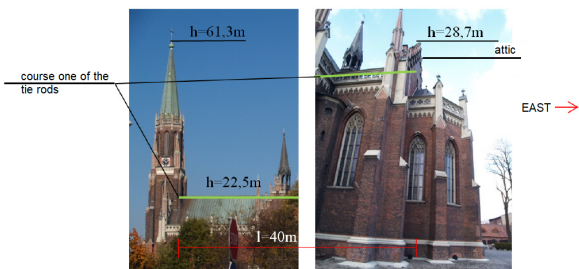

Figure 13. Church tower and analyzed attic – view from the south

Checking the straightness of declination of the attic from the vertical line

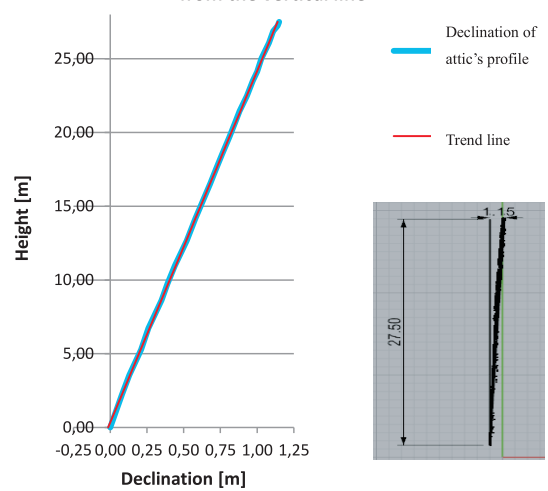

Figure 15. Checking the straightness of declination of the attic from the vertical line

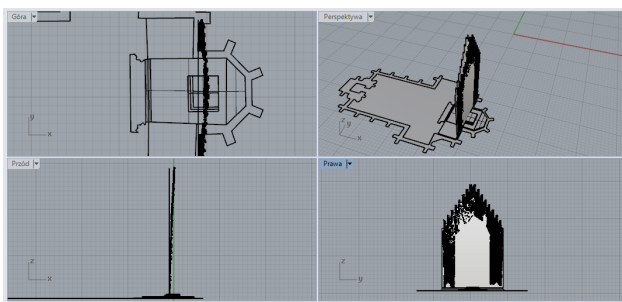

Figure 14. Declination of the attic cross-section from the vertical plane

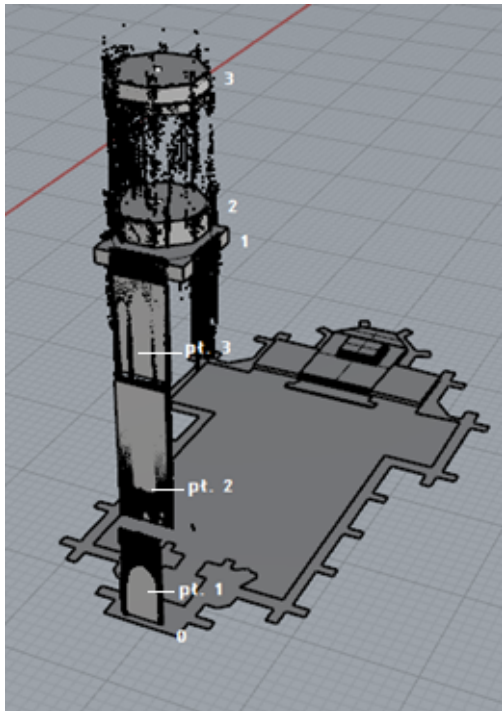

Figure 16. Modeled parts of the church tower

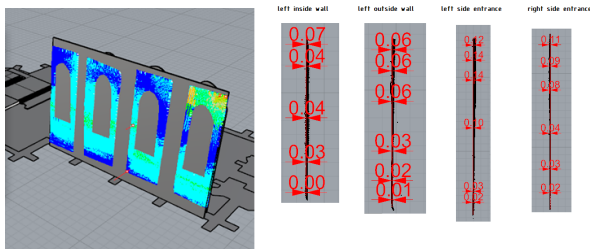

Figure 17. Declination vectors of the side walls from the vertical line [m]

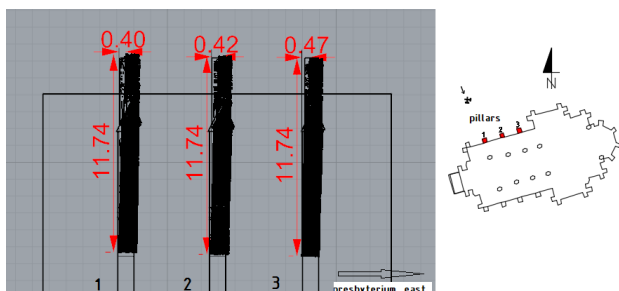

Figure 18. Vectors of the edge of the outer pillars from the vertical [m]

table below (Tab. 6 and Fig. 20).

As described above, all analyzed elements tends to decline towards the church presbytery (approximately to the east direction, Fig. 20). The results below (Tab. 6) show that the declination of the church’s construction elements is approximately 28 ‰, with the exception of the attic which has been much heavier (41‰) and external pillars whose declination values is not accurate enough and it cannot be considered as reliable to determine the declination of the external pillars.

Based on the results obtained, it can be stated that church structure behaves monolithically and undergoes the same deformations (Fig. 20). The direction of these deformation is consistent with the direction of formation of the depression trough, both predicted and measured (Fig. 2). It should be noted that the calculated value of the terrain around the church, based on leveling measurement obtained from the mine, is about 13.8‰ which is much lower than analyzed elements. It should be remembered, however, that the declinations that occurred during 2014 exploitation and the previous ones have resulted in overexert of the object construction, prolonged deformation, and retention of structural elements. All the above-mentioned values of object’s elements declination belong to 5th category of mining areas which is more than ten times greater for large-space historical object. At the moment there is no coal exploitation planned in this area, and existing damage has been repaired or under repair. The reinforcements and preservations of the church’s construction applied so far have increased their safety, however ongoing building control and abandonment of coal exploitation under the church is strongly advised.

After careful and perceptive analysis of received data and measurements made, the following conclusions were drawn:

- i. Received values measured by the employees of surveying-geological department of KWK “Bobrek-Centrum” mine are significantly lower than forecasted, which may be due to the use of protection structure in the form of reinforced concrete outer plate.
- ii. Based on the measurements of network points using GPS GNSS method approximation of the correspondence of dislocation direction was verified.
- iii. Using modern technologies such as laser scanning, it is possible to obtain a very wide database of the object at a relatively small workload and time compare to classical surveying measurement methods.
- iv. Results obtained from cloud point could analysis can be considered as completely reliable for simple construction elements. When the item is built up or obscured, it becomes difficult to accurately model or dimension it, as in the case of church tower and external pillars. Such analyzes could only be improved if the exact dimensions were known.
- v. Periodic verification of applied protection of the church by control measurement of construction elements declination is strongly advised.
- vi. Thanks to applied protections and on-going repairs, despite the alarming results of church’s elements tilts, the objects does not show any additional structural changes.

Acknowledgements

The article was made in the framework of statutory research AGH University of Science and Technology nr 11.11.150.195.

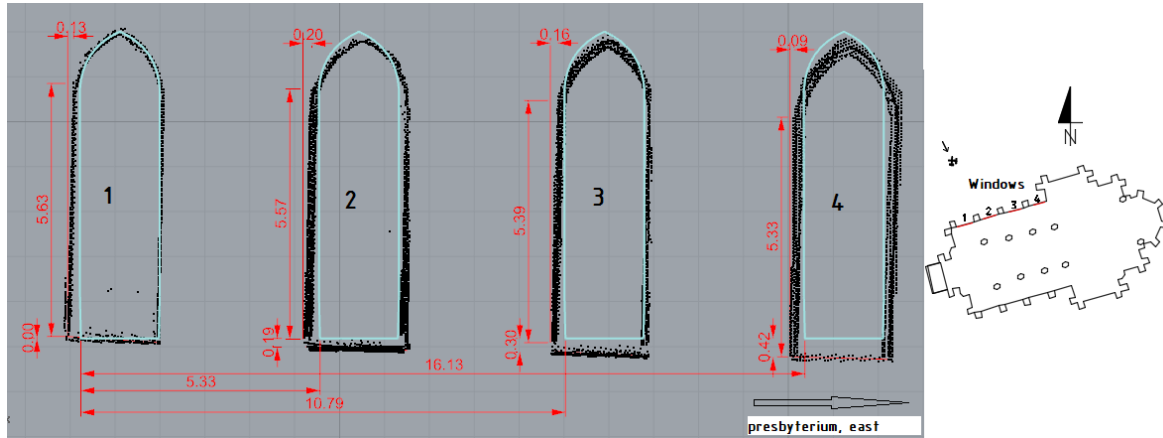

Figure 19. Declination vectors of window opening edges [m]

Table 6. Generalized values of church structural elements declination [own elaboration]

Element	[g]	Declination				
		[%]	[‰]	[mm/m]	[mm]	H[m]
Pillars – maximum value	1.8440	2.90	29.0	28.974	290	10.00
Attic	2.6607	4.18	41.8	41.818	1200	28.70
Tower – the whole tower declination	1.7552	2.76	27.6	27.578	1028	37.28
External Pillars – maximum value	2.5473	4.00	40.0	40.034	470	11.74
Windows – the longest stretch	1.6573	2.60	26.0	26.038	420	16.13*

* Distance between windows 1 and 4 [m]

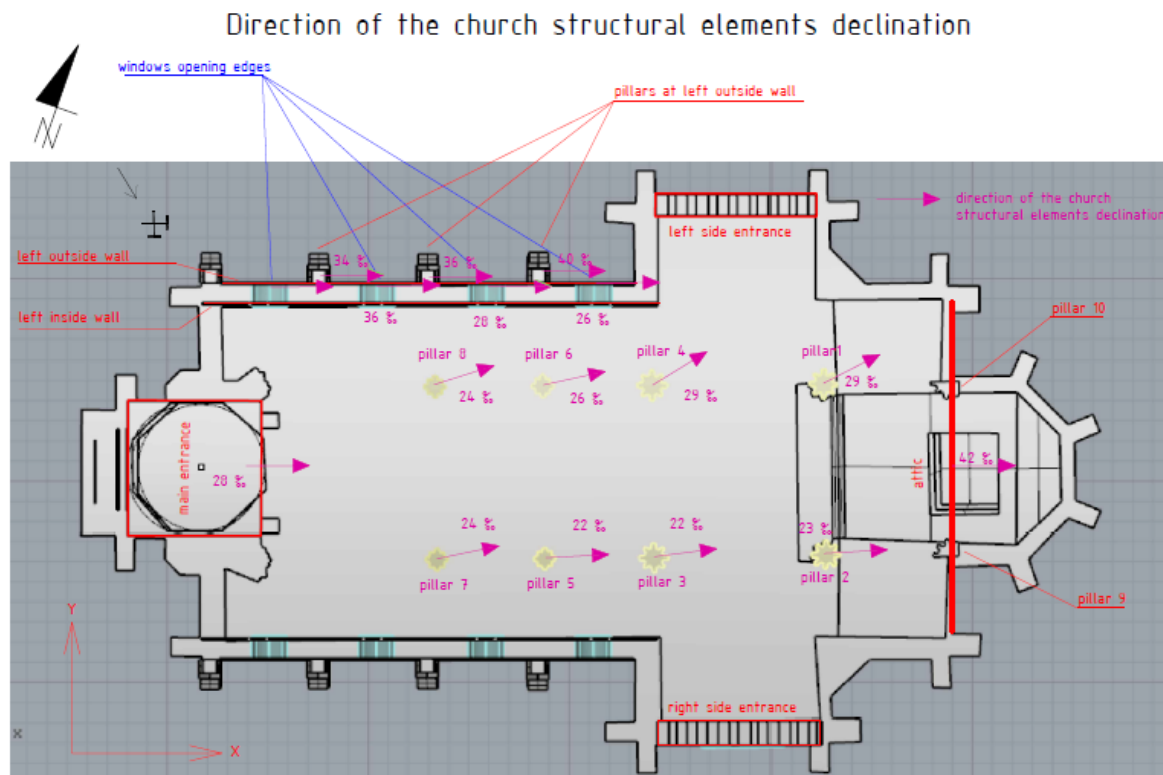

Figure 20. Direction of the church structural elements declination

References

- Budryk, W. and Knothe, S. (1956). *The principles of classification of Upper Silesia Industrial District lands with regard to possibility of using them for construction development*. Bulletin No. 4. Polish Academy of Sciences, Committee of Rock-Mass Mechanics.
- Hejmanowski, R. and Kwinta, A. (2010). Modelowanie deformacji ciągłych powierzchni terenu w warunkach zmiennego zalegania złoża (Modeling continuous deformation of terrain in variable conditions of deposition). *Mineral Resources Management*, 26(3):143–153.
- Jóźwik, M. and Jaśkowski, W. (2011). Monitoring przemieszczeń powierzchni i obiektów w rejonie „Dzieńkowice” ZG „Sobieski” (Monitoring of surface and objects displacements in the „Dzieńkowice” area of the „Sobieski” mine). *Research Reports, Mining & Environment*, 2(1):178–187.
- Kaszowska, O. (2007). Wpływ podziemnej eksploatacji górniczej na powierzchnię terenu. *Problemy Ekologii*, 11:52–57.
- Kawulok, M. (2010). *Szkody górnicze w budownictwie*. Wydawnictwa Instytut Techniki Budowlanej, Warszawa.
- Kawulok, M., Chomacki, L., and Słowik, L. (2015). Wzmocnienie znacznie wychylonej atyki kościoła na dalsze wpływy górnicze. In *XXVII Konferencja Naukowo-Techniczna*.
- Kwiątek, J. (1997). *Ochrona obiektów budowlanych na terenach górniczych*. Wydawnictwo Głównego Instytutu Górniczego, Katowice.
- Ledwoń, J. A. (1983). *Budownictwo na terenach górniczych*. Wydawnictwo GIG, Katowice.
- Ligarska, H. and Zawadzka, M. (2016). Monitoring wpływu eksploatacji górniczej na kościół pw. św. Krzyża w Bytomiu-Miechowicach. Master's thesis, Akademia Górniczo-Hutnicza im. Stanisława Staszica w Krakowie.
- Lipecki, T. (2009). *Technologie GNSS i skaningu laserowego* Słowik, L., Chomacki, L., and Szołtysek, D. (2015). Doświad-
 w monitorowaniu kinematyki przemieszczeń obiektów budowlanych (The use of GNSS technology and laser scanning in the measurement geometry and the displacement of mining facilities.), volume 6 of *Archives of Institute of Civil Engineering*. Politechnika Poznańska.
- Lipecki, T. (2010). Skaniny laserowe w pomiarach geometrii i deformacji obiektów oraz urządzeń górniczych. *Przegląd Górniczy*, 66(7–8):25–31.
- Lipecki, T. (2011). *Modernizacja pomiarów osnów kontrolnych w aspekcie wdrażania nowoczesnych technologii GNSS w celu określeniu przestrzennego pola deformacji terenu górniczego*, pages 314–322. *Prace naukowe GIG, X Dni Miernictwa Górniczego i Ochrony terenów górniczych: Górnictwo i środowisko*. Główny Instytut Górniczego, Katowice.
- Niedojadło, Z., Piwowarski, W., Mościcki, W., Sopata, P., Stoch, T., Bania, G., and Ćwiklik, M. (2016). Wpływ lokalnej, przypowierzchniowej budowy geologicznej na deformacje powierzchni terenu w warunkach podziemnej eksploatacji górniczej (The impact of local surface geological structure on ground deformation under the conditions of underground mining exploitation). *Przegląd Górniczy*, 72(1):18–26.
- Ostrowski, J. (2015). *Deformacje powierzchni terenu górniczego (Surface deformations of protected mining area)*. Akademia Górniczo-Hutnicza im. Stanisława Staszica w Krakowie, Agencja Wydawniczo-Poligraficzna Art-Tekst.
- Popiołek, E. (2009). *Ochrona terenów górniczych*. Wydawnictwa AGH, Kraków.
- Popiołek, E. and Hejmanowski, R. (2008). Prognozowanie oraz monitorowanie wpływu podziemnej eksploatacji pokładów minerałów (Forecasting and monitoring of underground mineral seam exploitation influence). *Przegląd Górniczy*, 24(3):135–149.
- Szczeniuk, J. (2015). Wpływ eksploatacji górniczej pod obiektem kościoła pw. św. Krzyża w Bytomiu-Miechowicach. *Przegląd Górniczy*, 3:89–95.