

**Edward Czekaj, Stanisław Pysz**

## The application of a computer technique to assess the impact of chemical composition on dispersed shrinkage microporosity of hypoeutectic cast silumins

Wykorzystanie techniki komputerowej do oceny wpływu składu chemicznego na rozproszoną mikroporowatość skurczową podeutektycznych siluminów odlewniczych

---

### **Abstract**

This article presents the possibility of decreasing dispersed shrinkage microporosity in castings of hypoeutectic alloying silumins, as a result of narrowing – within the standards or industrial specifications – the content of particular elements of the chemical composition: alloying additions and/or impurities. This relatively-simple and, at the same time, inexpensive method can often lead to a quick solution of this type of defects in castings and the improvement of their tightness. In order to orientate the chemical composition towards an optimal content, computer-aided statistical processing was conducted (using *Statistica Ver. 9* software) with the application of figures directly related to shrinkage microporosity as well as indirectly related to the temperature range of crystallisation ( $\Delta T = T_{\text{lik}} - T_{\text{sol}}$ ). This data came from literature and *MAGMASoft*<sup>®</sup> software for simulations of pouring and solidification processes in castings. The achieved results were verified under industrial conditions.

**Keywords:** hypoeutectic silumins, shrinkage microporosity, castings tightness, computer simulation, statistical analysis

### **Streszczenie**

W artykule zaprezentowano możliwości zmniejszenia rozproszonej mikroporowatości skurczowej w odlewach z podeutektycznych siluminów stopowych, w wyniku zawężenia – w granicach normy lub specyfikacji przemysłowej – zawartości w nich poszczególnych elementów składu

chemicznego: dodatków stopowych i/lub zanieczyszczeń. Ten stosunkowo prosty, a zarazem tani sposób w wielu przypadkach prowadzi do szybkiego zlikwidowania wad w odlewach oraz poprawy ich szczelności. W celu ustalenia optymalnych zawartości składu chemicznego przeprowadzano komputerową obróbkę statystyczną (za pomocą programu *Statistica Ver. 9*) danych liczbowych dotyczących bezpośrednio mikroporowatości skurczowej, jak i – pośrednio – temperaturowego zakresu krystalizacji ( $\Delta T = T_{lik} - T_{sol}$ ). Dane te pochodziły z materiałów źródłowych oraz programu *MAGMASoft*<sup>®</sup> do symulacji procesów zalewania i krzepnięcia odlewów. Uzyskane rezultaty poddane zostały weryfikacji w warunkach przemysłowych.

**Słowa kluczowe:** podeutektyczne siluminy, mikroporowatość skurczowa, szczelność odlewów, symulacja komputerowa, analiza statystyczna

## 1. Introduction

The basic defect of castings that lowers their physico-chemical, mechanical, and exploitation properties (as well as economy indicators of the production process) has been porosity – both of shrinkage, gas, and mixed character [1].

In many cases of strategic construction elements produced on a large-series scale – for example: heads or blocks for combustion engines, wheels, housing and cover for gearboxes or compressors, containers for industrial liquids, elements for chemical apparatuses, and others – their defects are often revealed after the process of casting, heat treatment, or subtracting manufacturing. The elimination of defective elements occurs even later; after tests: (1) X-Ray; (2) Computed Tomography; (3) tightness tests; (4) the assessment of hardness, and others. It causes significant financial losses in the production process. The limitation of casting defects by even a few percent allows a considerable improvement of cost-effectiveness of a foundry, especially when it comes to average- and large-scale production.

A significant improvement in this scope can be achieved by using computer software at the stages of designing and correcting the technological process for the production of castings. This allows not only modelling (simulation) of heat phenomena related to solidification and cooling down (*MAGMASoft*<sup>®</sup>, *ProCAST* or *Flow3D*), but also predicting: (1) microstructure elements (phase composition, *SDAS* – secondary dendrite arm spacing), (2) physico-mechanical properties ( $\rho$ ,  $R_m$ ,  $R_{p0.2}$ ,  $HB$ ,  $A$ ), and (3) foundry characteristics (fluidity, shrinkage porosity) or (4) parameters of heat treatment [2–5].

A lot of information about physico-chemical and mechanical properties gathered in source materials (specialist literature, patent descriptions) and databases of software programs for the simulation of processes of pouring, solidification, and cooling down of castings allows drawing practical conclusions about the creation of porosity to a high degree – without the need to apply expensive and long-lasting experiments or ineffective methods of trial and error.

The present publication shows the possibility of applying *MAGMASoft*<sup>®</sup> software to assess the impact of a chemical composition of alloying silumins on shrinkage microporosity in selected parts of a test casting. The statistical analysis was applied also in relation to

figures of the temperature range of crystallisation as an indirect indicator of the tendency for shrinkage porosity, to foundry silumins marked according to the system adopted by the Aluminium Association, which come from the work of J.G. Kaufman and E.L. Rooy [6].

## **2. The porosity castings in the light of literature database**

### **2.1. The characteristics of reasons for the creation of shrinkage porosity**

Shrinkage, gas, or mixed porosity in connection with oxide and other non-ferrous precipitations constitutes the main reason for the lack of tightness of castings; while defects of macro- or microstructure are very often interrelated [7]. Tightness is an important exploitation parameter of castings that operate under the influence of fluids and/or gases under increased pressure [7, 8]. There is an opinion among specialists that has been proven by an experiment that, in principle, every casting is porous to a certain degree; what matters is mostly the impermissible, from the point of view of exploitation, level of porosity.

Shrinkage porosity, which occurs in castings during crystallisation, may be divided into two types: (1) contraction cavity; and (2) dispersed porosity [9, 10].

A concentrated contraction cavity (macroporosity) is created when a relatively-big area of the liquid phase is surrounded by a solidified solid phase. In this case, it is required to design in such places of casting mould feeders/risers, in which liquid metal would crystallise in the last place [11]. In many cases, big single voids occur in upper fragments of castings [10].

Dispersed shrinkage porosity (microporosity) is characteristic of central (axial) areas of castings and local swellings (heat centres), in the case of alloys of a wide temperature range of crystallisation [10]. In this case, interlacing dendritic arms are created that firstly limit and finally prevent liquid alloy from infiltrating their internal micro areas (intra-grain spaces [12]) and their feeding. In this way, micro-cavities and/or dispersed shrinkage porosity (microshrinkage) is created [11].

Shrinkage porosity is often accompanied by gas porosity; then, we can speak of its mixed character; i.e., shrinkage-gas porosity [10–11].

In a metallographic specimen or a cross-section of a casting, gas porosity has smooth internal surfaces; in case of shrinkage porosity or gas-shrinkage porosity – this surface is usually “jagged.”

One of easier and cheaper ways of “fighting” against microporosity is correcting the chemical composition of alloy within the limits of standards or industrial specifications, and also changing the type of alloy. According to authors of the paper [13], the reasons for shrinkage porosity in aluminium alloys related to the chemical composition, among others, are: (1) inadequate grain refining, (2) low content of silica, and (3) inadequate content of gas. In another publication [14], it is recommended to eliminate shrinkage defects in large cross-sections of die castings of aluminium alloys both by redesigning their construction as well as by changing the gating and feeding systems, and by correcting metal and the temperature of the casting mould. Correction of

the chemical composition should be going in this direction to decrease the temperature range ( $T_{lik} \dots T_{sol}$ ) of solidification [14]. In extreme cases, it is suggested [14, 15] – apart from using other procedures – to change the type of alloy.

Apart from the character of alloy crystallisation, the reasons for shrinkage porosity lie within the construction of a casting (e.g., a sudden change from thin to thick cross-sections and vice-versa), with lack of directional solidification caused by inadequate selection of the position and dimensions of elements of a gating system, as well as side feeders or risers. Some of the possible reasons for creating shrinkage porosity in castings and its preventing measures are illustrated in Figure 1.

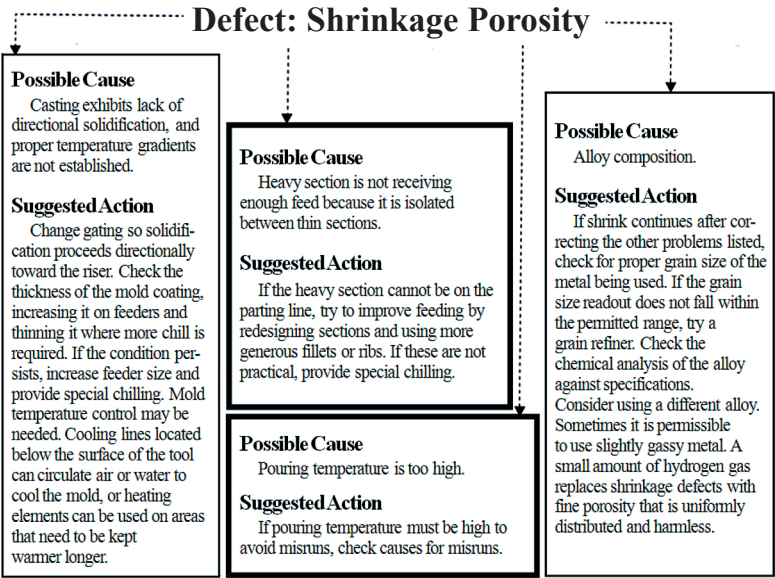

Fig. 1. Possible reasons for creating shrinkage porosity in castings and suggested ways of its elimination [15]

From the presented possibilities – the diagram in Figure 1– it can be seen that one of the reasons for shrinkage porosity in castings is an inadequate chemical composition of alloy. In the case of its accordance with the specification, its optimisation should be made within the limits of permissible content of alloy additions and/or impurities; alternatively, it is suggested to change the type of alloy. However, in many situations, the change of alloy is impermissible [14]. After applying these procedures, one should try to change the parameters of the casting technology; specifically: (1) change the position and dimensions of elements of the gating system, (2) consider placing feeders and/or risers on an optimum size in heat centres. All of these procedures should be preceded by – first and foremost – modelling (simulation) of pouring, crystallisation, and solidification processes in a casting with the use of specialty software (*MAGMASoft*<sup>®</sup>, *ProCAST*, or others).

After the examination of the problem, it results that in available source materials there is no information about the impact of alloying additions (apart from silicon) and/or impurities on shrinkage porosity of foundry silumins. From the analysis of multicomponent systems Al-Si-X, Al-Si-X-Y, etc. (where: X, Y, – alloying elements and/or impurities), it results that both copper and magnesium increase the scope of crystallisation of silumins; thus, can be conducive to the increase of shrinkage porosity. Here a question arises: to what degree?

Tightness of a casting mostly depends on dispersed shrinkage porosity (microporosity, microshrinkage), and the classification of casting alloys in this scope is made in relation to the extent of  $\Delta T = T_{\text{lik}} - T_{\text{sol}}$  [7, 8]. The tightest silumins are quasi-eutectic systems: Al-Si, Al-Si-Mg, and Al-Si-Mg-Mn; lower tightness is characteristic of hypoeutectic alloys of the Al-Si system with additions of copper up to 1.0...1.5 (max.)% by weight; the worst in this respect are copper silumins (Al-Si-Cu system) with the Cu content above 2% by weight, for which  $\Delta T = T_{\text{lik}} - T_{\text{sol}} \geq 100$  K. Among other aluminium alloys for casting, the least tight are wide-range alloys of Al-Cu or Al-Cu-Mg systems (with the Cu content 4.0–6.0% by weight), and alloys of the Al-Mg system (with the Mg content approx. 10%) [7, 8]. Due to the exceptionally-wide scope of crystallisation temperature (reaching 150°C and more), a significant degree of shrinkage porosity and, consequently, low tightness can be found in castings made of alloys of the system: Al-Mg-Zn-(Cu)-(Mn) or Al-Zn-Mg-(Cu)-(Mn).

## 2.2. The scope of crystallisation and dispersed shrinkage porosity

As early as 1947 in a work by A.A. Bochvar and Z.A. Sviderskaya [16], attention was paid to the relationship between the tightness of castings and the temperature scope of alloy crystallisation [8, 17].

In the synthesis of alloys [9, 18, 19], the criterion of porosity  $\delta$  (1) is taken into consideration, which results from (among others) the analysis of alloy phase diagrams for the systems matrix-alloying element (addition or impurity):

$$\delta = |T_o - T_p|/\alpha \quad (1)$$

where:

$T_o$  – the temperature of melting of alloy matrix, [K],

$T_p$  – the temperature of the transformation in the system matrix-alloying element, [K],

$\alpha$  – the solubility limit of the alloying element (impurity) in the matrix in a solid state, [% at.].

From the relation (1), it results that the value of the criterion  $\delta$  is a function of temperature scope of alloy crystallisation; a higher  $\delta$  value relates to an increased susceptibility to create shrinkage porosity. Alloys which have a narrow  $\Delta T$  range are prone to create a concentrated contraction cavity; whereas alloys which crystallise in a wide temperature

range are conducive to the creation of dispersed porosity. The bigger the temperature range of crystallisation is, the higher the degree of dispersed microporosity and, consequently, the worse tightness of castings. Taking the fact of a temporary character of crystallisation in castings both concentrated porosity – relatively-big contraction cavities, and dispersed porosity (microporosity, microshrinkage) are created (Fig. 2 [20]).

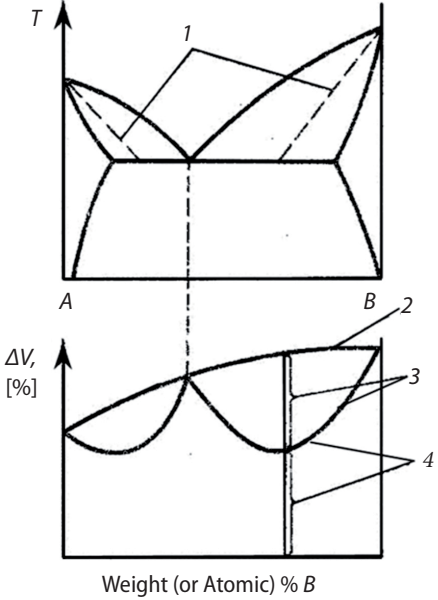

Fig. 2. The impact of the chemical composition of shrinkage in the process of crystallisation: 1 – the line of the beginning of linear shrinkage; 2 – the curve of change of volumetric shrinkage in alloy; 3 – the change of the volume of dispersed porosity; 4 – the change of the volume of a concentrated contraction cavity [20]

In the available publications, no precise relations were found between the scope of temperature range of alloy crystallisation and the size of created shrinkage microporosity (MPS), which is the relation:

$$MPS = f(\Delta T), \tag{2}$$

where  $\Delta T$  (in [K]) is mainly connected with the chemical composition of alloy (in the examined case: Si, Cu, Mg, ..., etc.; in % by weight).

Generally, authors refer to a probable increase in microporosity with a higher range  $\Delta T = T_{lik} - T_{sol}$  [10, 11, 21, 22]. For the purposes of industry practice, numerical models are created for the assessment of porosity in castings, verified and corrected by experimental data [23].

### 3. Results and discussion

The assessment of the impact of alloy additions and/or impurities on shrinkage microporosity of hypoeutectic alloying silumins is conducted on the basis of statistical processing – with the use of *Statistica Ver. 9* software – of data from self-conducted numerical calculations with the use of *MAGMASoft®* package and sources from the literature [6].

#### 3.1. Numerical calculations – *MAGMASoft®*

Numerical calculations, in the first place, were aimed at defining the character of the relation (2), for hypoeutectic alloying silumins; and further – at determining microporosity in a selected point of a test casting (Fig. 3) for an array – selected from the database of *MAGMANonferrous* module of *MAGMASoft®* software – of hypoeutectic silumins.

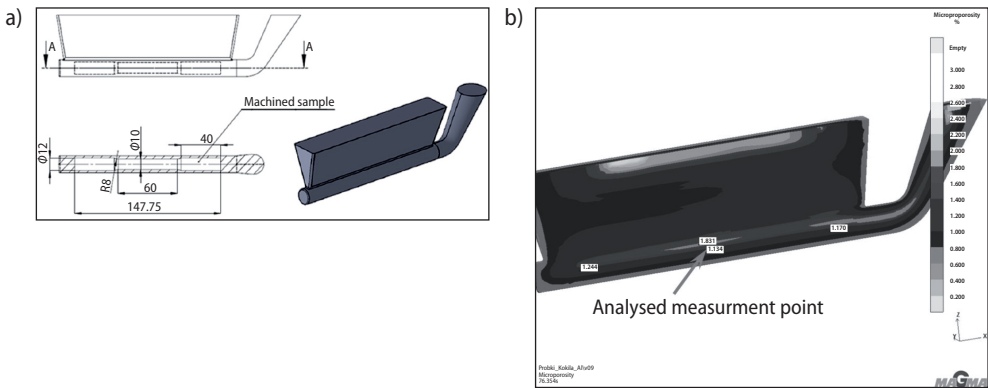

Fig. 3. The shape and dimensions of the experimental casting (tensile strength sample): a) used for simulation calculations; b) with the use of *MAGMASoft®* software (the arrow marks the point of measuring shrinkage microporosity)

#### 3.1.1. Shrinkage microporosity and the scope of crystallisation

In the first place, for the selected seven hypoeutectic alloy silumins (Tab. 1), the temperatures range of crystallisation ( $T_{lik} \dots T_{sol}$ ) was determined. To this end, from the curves of crystallisation achieved during the simulation the first derivative ( $\Delta T/dt$ , vide the diagram in Figure 4b) was calculated.

Extreme points of inflection constituted liquidus temperature and solidus temperature, respectively. Then, in a selected point of the test casting (Fig. 3b), shrinkage microporosity was determined. The results of these procedures for particular silumins are compiled in Table 1.

Table 1. Chemical compositions, temperature ranges of crystallisation and values of porosity in a selected point in the test casting (Fig. 3b) determined on the basis of data from MAGMASoft® package

Silumin number	Chemical composition, [% by weight]					$\Delta T = T_{lik} - T_{sol}$ [K]	Shrinkage porosity MPS*, [%]
	Si	Cu	Mg	Fe	Mn		
1	11.0	0.03	0.30	0.40	0.30	35.0	0.60
2	9.0	0.03	0.30	0.40	0.30	46.1	0.80
3	10.0	3.00	0.30	0.40	0.30	63.9	1.05
4	7.0	2.00	0.20	0.38	0.20	85.2	1.30
5	7.0	0.04	0.40	0.15	0.08	69.0	1.35
6	7.0	3.40	0.40	0.38	0.20	84.8	1.55
7	7.0	3.30	0.60	0.15	0.08	86.2	1.95

\* an average value on the basis of two measures read close to the measurement point

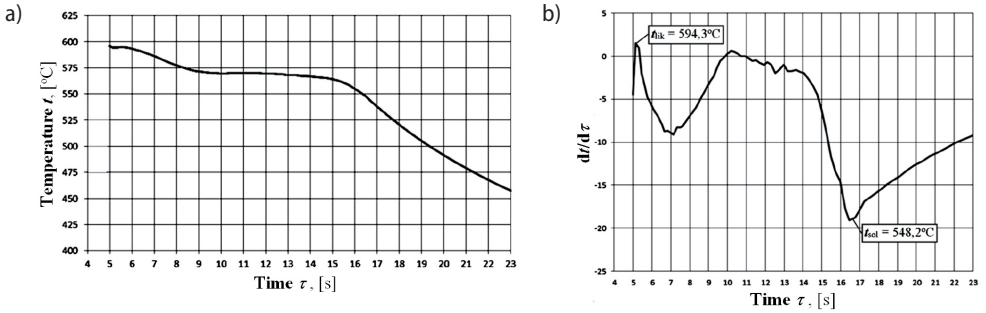

Fig. 4. A curve presenting silumin crystallisation no. 2 from Table 1 (a) and its first derivative (b)

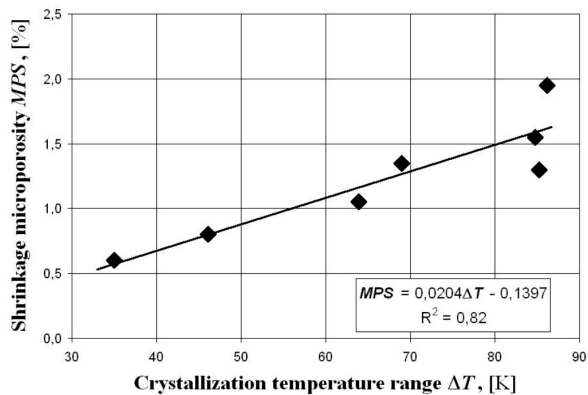

Fig. 5. A linear correlation between the temperature range of silumins crystallisation and the size of shrinkage microporosity on the basis of calculations made in MAGMASoft® software



The results of a linear correlation, determining the relation between microporosity and the temperature range, were obtained with the use of *Statistica Ver. 9* software, which is presented in Figure 5. The diagram presents a good relation (with correlation coefficient  $R^2 = 0.82$ ) between the temperature range of crystallisation and the value of shrinkage microporosity (MPS) in a selected point in the test casting.

### 3.1.2. The relation between shrinkage microporosity and the chemical composition

The determination of the relation between microporosity and the chemical composition was conducted for 16 types of foundry silumins (taken from the database of *MAGMASoft®*, according to American standards). Average values of shrinkage microporosity were determined on the basis of numerical calculations for three readings taken near the selected (established) measurement point for the test casting (Fig. 3). The chemical composition of the alloys examined is presented in Figure 6 (columns 1–5 of the dialogue box of *Statistica Ver. 9* software). In column 6 of this dialogue box, average values of shrinkage microporosity (MPS) can be found. The results of statistical calculations (according to a linear regression equation) are presented in Figure 7.

	1 Si	2 Cu	3 Mg	4 Mn	5 Fe	6 MPS
1	6,50	2,00	0,20	0,20	0,38	1,20
2	6,50	3,40	0,40	0,20	0,38	1,65
3	6,50	3,40	0,40	0,39	0,38	1,65
4	7,00	0,04	0,40	0,08	0,15	1,35
5	7,00	2,00	0,20	0,20	0,38	1,30
6	7,00	2,00	0,40	0,08	0,15	1,50
7	7,00	3,30	0,60	0,08	0,15	1,95
8	7,00	3,40	0,40	0,20	0,38	1,55
9	7,00	3,40	0,40	0,39	0,38	1,45
10	8,50	0,04	0,60	0,08	0,15	1,05
11	9,00	0,03	0,30	0,30	0,40	0,80
12	10,00	0,03	0,30	0,30	0,40	0,65
13	10,00	1,00	0,30	0,30	0,40	0,70
14	10,00	2,00	0,30	0,30	0,40	0,70
15	10,00	3,00	0,30	0,30	0,40	1,05
16	11,00	0,03	0,30	0,30	0,40	0,60

Fig. 6. The initial dialogue box of *Statistica Ver. 9* software: for selected alloying silumins taken from the database of *MAGMASoft®* package: columns 1–5 – define the content (in % by weight) of particular elements (alloying additions and/or impurities) in silumins used for calculations; column 6 – average values of shrinkage microporosity

Good adjustment of values approximated with a linear regression equation in relation to the initial values ( $R^2 = 0.95$ ) was achieved. It was decided to preserve insignificant coefficients in order to assess the estimated impact of the elements corresponding to them (alloying additions and/or impurities) on the controlled parameter (shrinkage microporosity). The removal of the coefficients and statistical recalculation did not cause any increase in the degree of adjustment of data to the model (regression equations). The force

of impact is best presented by standardised coefficients  $b^*$ , due to the possibility to compare them with the force of impact of other elements in examined ranges of changeability. Usually, the actual coefficients marked as  $b$  (Fig. 7) do not have such ability [24, 25].

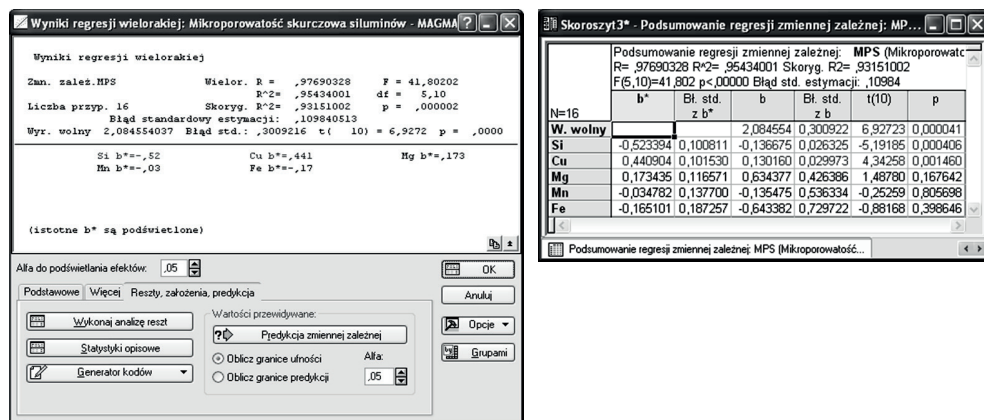

Fig. 7. The results of calculations of linear regression for the impact of the chemical composition of foundry siluminis (taken from MAGMASoft® database) in the average value of shrinkage microporosity (MPS) in a selected point in the test casting

In order to write down a mathematical model (linear regression) with the use of standardised values, values of mean and standard deviation both for input values (Si, Cu, Mg, Mn and Fe), and for the output MPS value are required. In Statistica software, it is easy to generate them in a dialogue box Skoroszyt9 (“Descriptive statistics”) (Fig. 8).

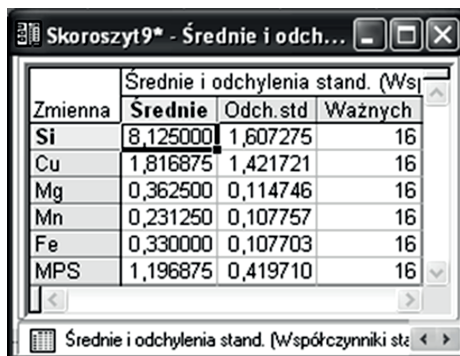

Fig. 8. Average values and standard deviations for input values (Si, Cu, Mg, Mn and Fe) and the output (MPS) value from Statistica Ver. 9 software

From the dialogue box Wyniki regresji wielorakiej (“Summary of regression”) in Figure 7 and regression equations expressed in actual values (3) and/or standardised values (4), it results (among others) that an increased content of silicon (in the examined scope)

will be slightly more conducive to decrease shrinkage porosity than copper – with its lower amounts.

$$MPS = 2.0846 - 0.1367 \cdot Si + 0.1302 \cdot Cu + 0.63440 \cdot Mg - 0.1355 \cdot Mn - 0.6434 \cdot Fe \quad (3)$$

$$(MPS - 1.1969)/0.4197 = -0.5234 \cdot (Si - 8.1250)/1.6073 + 0.4409 \cdot (Cu - 1.8169)/1.4217 + 0.1734 \cdot (Mg - 0.3625)/0.1147 - 0.0348 \cdot (Mn - 0.2313)/0.1078 - 0.1651 \cdot (Fe - 0.3300)/0.1077 \quad (4)$$

where:

$MPS$  – shrinkage microporosity [%],

Si, Cu, Mg, Mn, Fe – the content of elements of the chemical composition [wt. %].

A good possibility to analyse data at the level of intuition is by using contour diagrams presented in Figure 9.

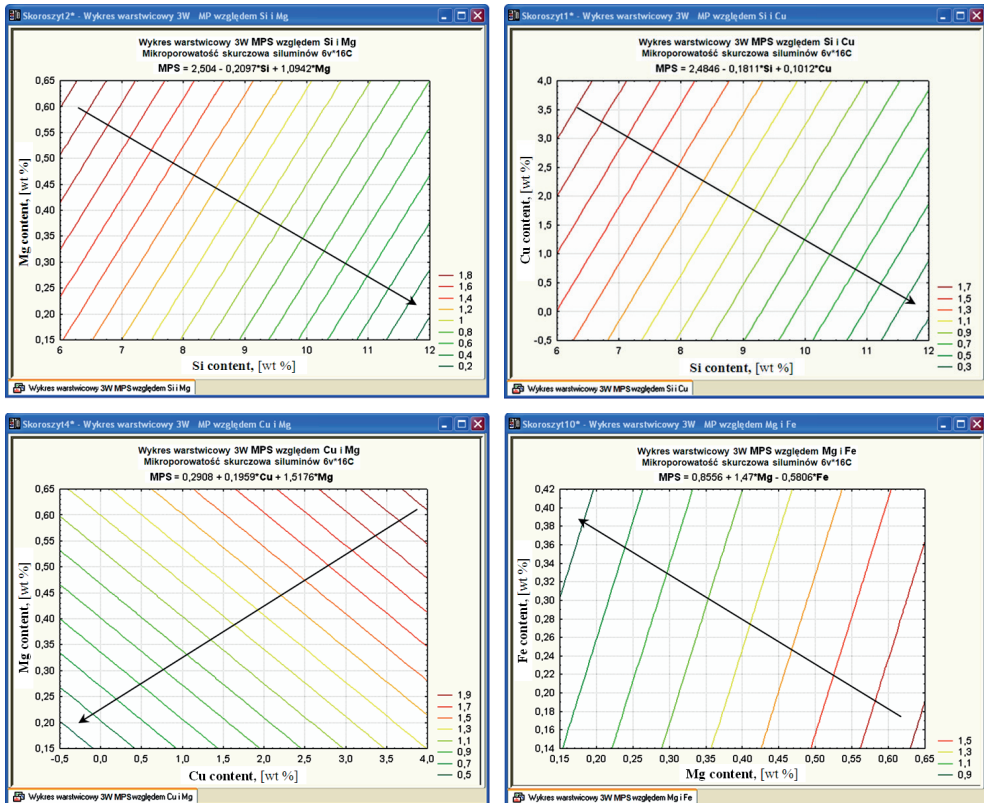

Fig. 9. Contour diagrams of the impact of Si, Cu, Mg and Fe (according to linear relation) on shrinkage microporosity (MPS), produced in alloying silumin, in a selected controlled point in Figure 3 (arrows indicate directions of porosity decrease)

From the achieved outcomes (Figs 7 and 9), it results that a higher content of silicon is conducive to lower shrinkage porosity, unlike in the case of copper and magnesium. This means that the content of these elements should be maintained in lower limits of permissible values (according to a standard or industrial specification). Higher amounts of iron (in examined limits of concentrations) are conducive to lower microporosity and, consequently, better tightness of a casting; whereas manganese practically does not influence the controlled parameter (*MPS*).

### 3.2. Literature database – Statistica

In the publication by J.G. Kaufman and E.L. Rooy [6], approximated ranges for melting (crystallisation) can be found for the majority of standardised (the USA, according to *Aluminium Association*) casting silumins of series 3XX.0 and 4XX.0. Calculated on this basis, temperature ranges of crystallisation ( $\Delta T = T_{lik} - T_{sol}$ ) are compiled in an output dialogue box of *Statistica Ver. 9* software (Figure 10, column 10). Nominal values of the content of alloy additions were assumed for statistical processing and in case of impurities – a half of their maximum (permissible) value was taken.

	1	2	3	4	5	6	7	8	9	10
	Si	Cu	Mg	Mn	Ni	Cr	Fe	Zn	Ti	$\Delta T$
1	5,500	4,500	0,050	0,250	0,000	0,000	0,500	0,500	0,125	95
2	6,000	3,500	0,050	0,250	0,175	0,000	0,500	0,500	0,125	85
3	8,000	1,500	0,400	0,400	0,125	0,175	0,500	0,500	0,125	80
4	9,500	3,000	1,000	0,250	0,250	0,000	0,600	0,500	0,125	60
5	9,000	3,500	0,280	0,250	0,250	0,000	0,500	0,500	0,125	65
6	12,000	1,000	1,000	0,175	2,500	0,000	0,600	0,175	0,125	30
7	9,000	1,800	0,500	0,050	0,000	0,000	0,100	0,050	0,100	60
8	5,000	1,250	0,500	0,250	0,000	0,125	0,300	0,175	0,125	70
9	7,000	0,125	0,320	0,175	0,000	0,000	0,300	0,175	0,125	55
10	7,000	0,025	0,520	0,015	0,000	0,000	0,075	0,025	0,100	55
11	9,000	0,100	0,600	0,050	0,000	0,000	0,100	0,050	0,100	40
12	9,500	0,300	0,500	0,175	0,250	0,000	1,000	0,250	0,000	39
13	8,500	3,500	0,050	0,250	0,250	0,000	1,000	1,500	0,175	55
14	10,500	2,500	0,050	0,250	0,150	0,000	0,650	1,500	0,075	66
15	11,200	3,800	0,050	0,250	0,250	0,000	0,650	1,500	0,175	66
16	12,000	0,500	0,050	0,175	0,250	0,000	1,000	0,250	0,000	8
17	5,200	0,300	0,025	0,250	0,000	0,125	0,400	0,250	0,125	55
18	7,000	0,050	0,025	0,050	0,000	0,125	0,100	0,050	0,100	55

Fig. 10. An output dialogue box of *Statistica 9.0* software in the system: chemical composition – range of crystal-lisation of casting silumins of series 3XX.0 and 4XX.0 according to AFS [6]

Figure 11 presents the results of calculations of linear regression coefficients for all alloying additions and impurities. Statistically-significant impact occurs in case of silicon, copper, and iron. Due to an insignificant impact of nickel and chrome on the temperature range of crystallisation  $\Delta T$ , a similar analysis was conducted without these elements of the chemical composition. The results of calculations in this case are presented in Figure 12.

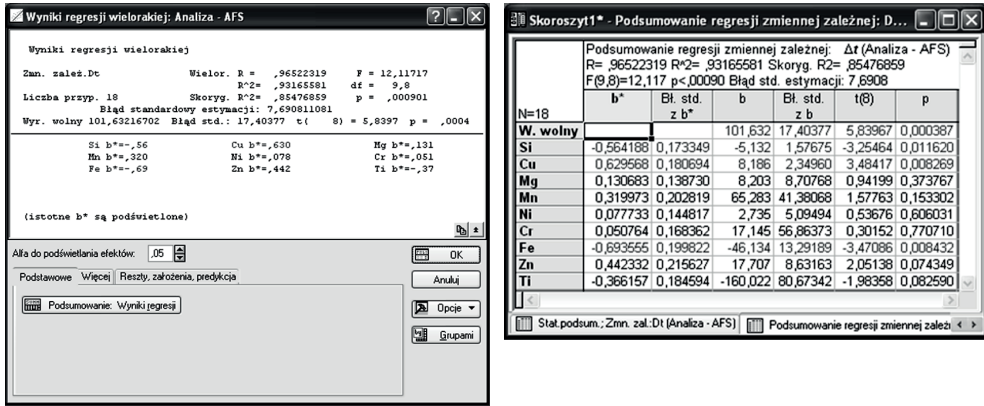

Fig. 11. Results of coefficient calculations ( $b^*$  and  $b$ ) of linear regression for the impact of elements of the chemical composition of silumins according to AFS on the temperature range of crystallisation  $\Delta T$

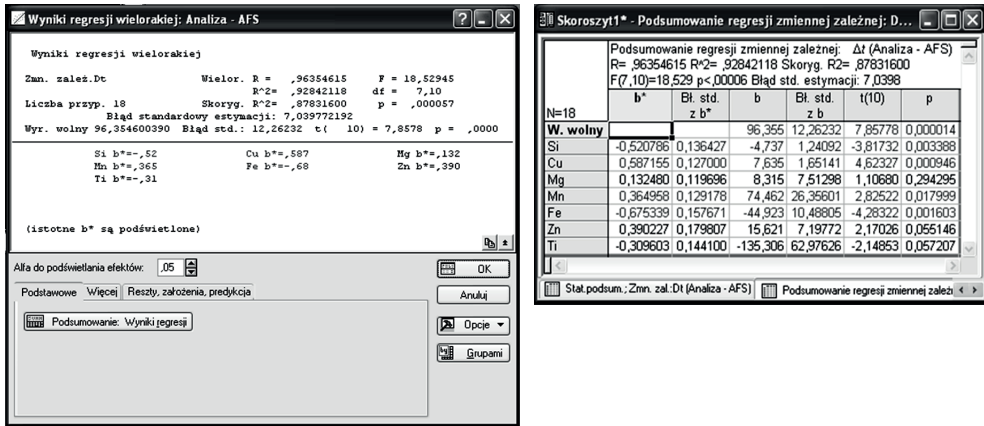

Fig. 12. Results of coefficient calculations ( $b^*$  and  $b$ ) of linear regression for the impact of elements of the chemical composition of silumins according to AFS on the temperature range of crystallisation  $\Delta T$

While comparing statistical figures presented in Figures 11 and 12, it is not difficult to notice that only a slight correction of coefficient values occurred for the preserved elements (alloying additions and impurities). Assuming similar circumstances (paragraph 3.1.2), preserved were less-statistically-certain values of coefficients  $b^*$  and  $b$  for Mg, Mn and Ti. An exemplary geometrical interpretation in the form of contour diagrams is presented in Figure 13.

From the conducted statistical analysis (Figs 11, 12, and 13), it can be concluded that the temperature range of crystallisation will be lower in the case of levels of silicon, iron and titanium in upper ranges. A contrary situation will occur in the case of copper, magnesium, manganese, and zinc; i.e., their content should be kept – as far as possible – in lower ranges defined by standards or industrial specifications.



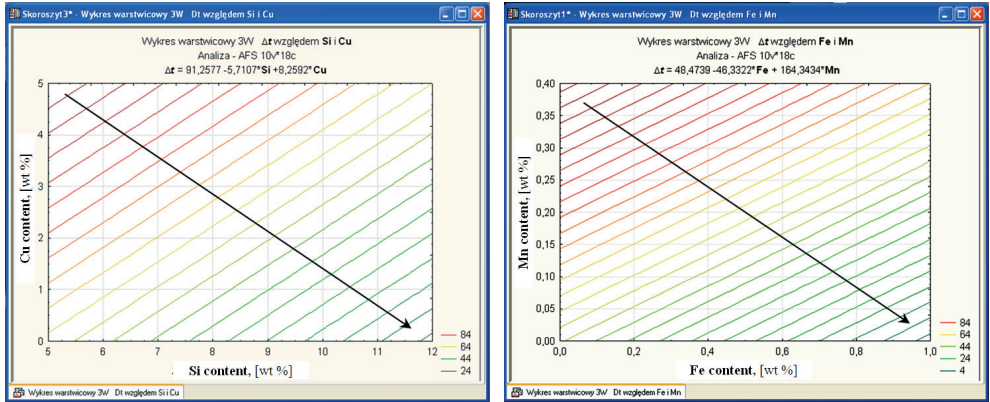

Fig. 13. Contour diagrams of the scope of crystallisation ( $\Delta T$ , [K]) of silumins in relation to the content of alloying additions and/or impurities in these silumins (Si and Cu, as well as Fe and Mn), developed on the basis of data taken from an American source [5] – the arrow points in the direction of lowering the value of the crystallisation scope

While comparing the values of coefficients of regression equations in Figures 7 and 12, it should be noted that, in light of current findings, there is not an explicit direction of manganese impact in shrinkage microporosity of foundry silumins. From the contour diagram for Fe and Mn in Figure 13, it results that a lower temperature range of crystallisation of alloying silumins will occur if the content of manganese is as low as possible. The situation is slightly different when it comes to a statistical analysis of data of shrinkage microporosity calculated in *MAGMASoft*<sup>®</sup> (Fig. 6). Similarly, in the publication [26], it is stated that (among others) manganese favourably influences the decrease in porosity in castings produced of silumins.

These various statements raise the need to conduct special verifying laboratory and/or industrial research. All the more, in the publication [27], Slovakian authors state in the summary of their experimental research that alloying silumins with a wider range of crystallisation have, generally speaking, a lower tendency to create shrinkage porosity (of a total character, as a sum of macro- and microporosity – Figure 2) in castings. This may seem contradictory to the calculation figures and research results conducted under industrial conditions and achieved in the present paper (paragraph 4).

#### 4. Industrial verification

The achieved results of computer calculations were verified in two foundries in Poland. The introduced corrections of the chemical composition of silumins in a significant way contributed to a decrease in porosity in castings, an increase in their tightness (hydraulic testing), and, consequently, also to a drop in the number of defective casings and improved cost efficiency of production. The possibility to considerably improve the quality

of castings in the aspect of microporosity was proven in practice. As a result, improved tightness was achieved by applying changes in the content of particular elements of the chemical composition before introducing more-expensive solutions connected with changes in the casting technology – changing the gating system, applying additional feeders or risers, etc.

## 5. Conclusions

The research and calculations lead to the following conclusions:

- Shrinkage microporosity is the main reason for the lack of tightness in castings; in many cases, it can be a significant limitation by adjusting the chemical composition of silumins; good enough may be indications resulting from the statistical analysis of data from the literature and results of numerical modelling (simulation) of solidification and cooling-down processes in castings (in a simplified version – test elements).
- There is a certain relationship between the temperature range of crystallisation and shrinkage microporosity proven by experimental data. From the conducted numerical research and the statistical analysis, it results that a smaller scope of crystallisation decreases microporosity – which is an effect of a particular (corrected) chemical composition of alloy.
- To this date, there have been no formal mathematical models and theories relating microporosity with the scope of crystallisation; only approximations are used which result from numerical calculations and experimental data. For practical purposes, it is useful to examine the impact of elements of the chemical composition both on  $\Delta T = T_{\text{lik}} - T_{\text{sol}}$  and shrinkage porosity. Their results for dual systems are currently insufficient.
- From all conducted calculations, it results that higher content of silicon in hypoeutectic silumins is conducive to better tightness of castings. In this context, the content of copper and magnesium should be restricted to the lower range determined in the national, trade, or casting standard (specification).
- The desired content of magnesium (from the point of view of shrinkage microporosity) has not been conclusively determined. Also unclear is the positive role of iron resulting from calculations in the aspect of tightness of castings produced of alloying silumins. Undoubtedly, the impact of Fe and Mn should be considered in interaction as well as relationship to other elements of the chemical composition of alloying silumins.
- The application of information from computer calculations relatively quickly allowed the correction of the chemical composition of alloys and, consequently, a decrease in their porosity and an increase in tightness of castings under industrial conditions.

## References

- [1] Bonollo F., Fiorese E., Timelli G., Amberg L., Adamane A.C.R.: StaCast Project: from a Survey of European Aluminium Alloys Foundry to New Standards on Defect Classification and on Mechanical Potential of Casting Alloys. 71<sup>st</sup> World Foundry Congress, Bilbao, Spain 2014
- [2] Bazhenov V.E., Koltygin A.V.: Optimizatsiya sostava splava AK5M s pomoshch'yu programmy ProCAST. Liteynoye proizvodstvo, 12 (2011), 27–28
- [3] Pabel T., Bozorgi S., Kneißl C., Habarl K., Schumacher P.: Einfluss des Kupfer- und Magnesium-gehaltes auf die Warmrissempfindlichkeit von AlSi7MgCu-Gusslegierungen. Gießerei-Rundschau, 58, 3–4 (2011), 50–56
- [4] Prediction of casting properties and performance through an overall process chain. FTJ, July/August 2012, 186–188
- [5] Pysz S., Piekło J.: Zastosowanie zintegrowanego systemu modelowania materiałów i procesów inżynierskich (ICME) w odlewnictwie. Prace Instytutu Odlewnictwa, LIII, 4 (2013), 57–70
- [6] Kaufman J.G., Rooy E.L.: Aluminum Alloy Casting. Properties, Processes and Applications. American Foundry Society, Schaumburg; ASM International® Materials Park; second printing, April 2005
- [7] Postnikov N.S., Mel'nikov A.V.: Proizvodstvo litykh alyuminiyevykh detaley. Metallurgiya, Moskva, 1979
- [8] Stroganov G.B.: Vysokoprochnyye liteynyye alyuminiyevyye splavy. Metallurgiya, Moskva, 1985
- [9] Gulyayev B.B.: Sintez splavov (Osnovnyye printsipy. Vybor komponentov). Metallurgiya, Moskva, 1984
- [10] Aitchison L., Kondic V.: The casting of non-ferrous ingots. MacDonald & Evans Ltd, London, 1953
- [11] <http://www.substech.com/dokuwiki/doku.php?id=solidification> [2.04.2015]
- [12] Braszczyński J.: Teoria procesów odlewniczych. PWN, Warszawa, 1989
- [13] Casting Defects Hand Book. American Foundry Society (AFS), Schaumburg, Illinois 60173 USA 2005
- [14] International atlas of casting defects. American Foundry Society (AFS), Inc. Des Plaines, Illinois 60016-8399 USA 1993 (Reprinted 1999)
- [15] Perm Mold Problem Solvers. Modern Casting, February 2012, 40–43
- [16] Bochvar A.A., Sviderskaya Z.A.: O razrushenii otlivok pod deystviem usadochnykh napryazheniy v period kristallizatsii v zavisimosti ot sostava. Izv. AN SSSR, OTN, 3 (1947), 349–354
- [17] Korol'kov A.M.: Usdochnyye yavleniya v splavakh i obrazovanyye treshchin pri zatverdevanii. Izd. Akademii Nauk SSSR, Moskva, 1957
- [18] Gulyayev B.B.: Sintez liteynykh splavov. Uchebnoye posobiye. Izd. Leningradskogo Gosudarstvennogo Tekhnicheskogo Universiteta, Leningrad, 1991
- [19] Sobczak J.: Podstawy syntezy stopów. Wydawnictwo Instytutu Odlewnictwa, Kraków, 1997
- [20] Kurdyumov A.V. (ed.), Laboratornyye raboty po tekhnologii liteynogo proizvodstva, Vtoroye izdviye pererabotannoye i dopoyanennoye, Mashinostroyenyye, Moskva, 1990
- [21] <http://www.ai08.org>: Usadochnaya poristost' – tekhnicheskiiy slovar' Tom V. [17.11.2014]
- [22] Ott D.: Chaos in Casting: An Approach to Shrinkage Porosity. Gold Bulletin, 30, 1 (1997), 13–19
- [23] Sabau A.S., Viswanathan S.: Microporosity Prediction in Alloy Casting. Metallurgical and Materials Transactions B, 33 (2002), 243–255
- [24] Czekaj E.: Bezniklowe siluminy tłokowe o podwyższonej stabilności wymiarowej. Wydawnictwo Instytutu Odlewnictwa, Kraków, 2011
- [25] Stanisław A.: Przystępny kurs statystyki z wykorzystaniem programu STATISTICA PL® na przykładach z medycyny. Tom II. StatSoft Polska, Kraków, 2000
- [26] Khokhlev V.M.: Proizvodstvo liteynykh alyuminiyewo-kremniyevykh splavov. Metallurgiya, Moskva, 1980
- [27] Kucharčík L., Brůna M., Sládek A.: Influence of Chemical Composition on Porosity in Aluminum Alloy. Archives of Foundry Engineering, 14, 2 (2014), 5–8