

A new extrusion head with integrated ultrasonic device and online process parameters measurements system — design and testing^{*})

Manuel Muniesa¹⁾, Ángel Fernández^{1, 2)}, Isabel Clavería^{1, **)},
Carlos Javierre¹⁾, Jon A. Sarasua³⁾, Miren Blanco³⁾

DOI: [dx.doi.org/10.14314/polimery.2015.209](https://doi.org/10.14314/polimery.2015.209)

Abstract: A new extrusion die with integrated ultrasonic device and online viscosity monitoring system was designed. This new construction was tested in the process of high density polyethylene (PE-HD) extrusion. Ultrasonic vibration is applied at various flow rates of material flowing through the output die channel, making the process more efficient. Under ultrasounds application, extrudate flow rate is enhanced by up to 10 %. Die pressure is reduced by up to 16 % for all the rates studied, being this reduction higher as flow rate is lower. Viscosity values are reduced by between 5 and 8 %, depending on the flow rate applied. Temperature is slightly increased.

Keywords: extrusion, head design, ultrasounds, viscosity, parameters monitoring, extrudate.

Nowa głowica wylączarki z wbudowanym urządzeniem ultradźwiękowym i układem bezpośredniego pomiaru parametrów procesu — projekt i testowanie

Streszczenie: Zaprojektowano nową głowicę wylączarki z wbudowanym urządzeniem ultradźwiękowym i systemem bezpośredniego pomiaru lepkości stopionego polimeru. Tę nową konstrukcję testowano prowadząc proces wylączania polietylenu dużej gęstości (PE-HD). Badano wpływ wibracji ultradźwiękowych na efektywność procesu wylączania przy różnych szybkościach przepływu stopu polimeru przez kanał dyszy wylotowej. Zastosowanie ultradźwięków powodowało zwiększenie przepływu stopu nawet o 10 %. W przypadku wszystkich badanych szybkości przepływu zaobserwowano zmniejszenie się ciśnienia w dyszy wylotowej, przy czym zmniejszenie to było tym większe (osiągając 16 %) im mniejszy był przepływ. Wibracje ultradźwiękowe powodowały także spadek lepkości od 5 do 8 %, w zależności od zastosowanej szybkości przepływu. Energia ultradźwięków dostarczana do stopu tylko nieznacznie zwiększała jego temperaturę.

Słowa kluczowe: wylączanie, konstrukcja głowicy, ultradźwięki, lepkość, monitorowanie parametrów, wylączyna.

Extrusion is one of the most promising methods for thermoplastic processing in industrial applications, because it is productive, environment friendly and it can be easily scaled up [1]. In recent years several innovations in extrusion have arisen [2–4], such as the usage of new

biomaterials to facilitate biodegradation [5, 6], or the usage of nanoreinforcements to improve both mechanical properties [7] and processing conditions [8]. On the other hand, the cost of the new products obtained by extrusion needs always be reduced to become competitive. Numerous efforts have been made to improve extrusion processing, and the application of ultrasounds may render an opportunity to achieve this objective.

It is known that ultrasonic waves acting on a melt polymer cause chain rupture and a decrease in molecular weight, so apparent viscosity is reduced. A physical contribution to decreasing viscosity is also found in the improving of the motion of molecular chains and decreasing elastic tensile strains [9]. Application of ultrasonic energy can lead to cavitation by generating waves and bubbles [10] and collapsing of these bubbles generates hot spots at very high temperatures and pressure that

¹⁾ University of Zaragoza EINA, Mechanical Department, Maria de Luna 3, 50018 Zaragoza, Spain.

²⁾ AITIIP Foundation, Poligono Industrial Empresarium, C/Romero 12, 50720 Zaragoza, Spain.

³⁾ IK4-TECHNIKER, Polo Tecnológico Eibar, C/Iñaki Goenaga 5, 20600 Guipuzkoa, Spain.

^{*}) Materials contained in this article was presented at Global Conference on Polymer and Composite Materials, 27–29 May 2014, Ningbo, China.

^{**)} Author for correspondence; e-mail: isabel.claveria@unizar.es

cause reactions [11]. The study of the influence of the application of ultrasonic waves on pressure flow through a circular die has been deeply studied for extrusion process [12]. Oscillating parameters such as frequency and amplitude change the rheological and mechanical behavior of different materials including filled and unfilled thermoplastics and thermoplastic elastomers in a wide range of processing parameters. Depending on the ultrasonic wave amplitude and chemical composition of the polymer, molecular chains can be reorganized to create high molecular weight polymeric chains as described in [13]. Other reactions stimulated by the application of ultrasounds are those related to copolymerization in immiscible components rubber/rubber, rubber/polymer, and polymer/polymer [14], and homopolymerization with polyamide 6/polypropylene (PA6/PP) components [15]. These reactions are carried out during melt material processing at the local area where ultrasounds are applied with very short residence time. Ultrasounds assisted extrusion has been used also for blends compatibilization [16]. It was found that ultrasonic treatment during extrusion improved the creation of copolymers due to the generation of long-chain radicals. Ultrasounds cause thermo-mechanical degradation of polymers and increase the branching of high density polyethylene (PE-HD). The research of the rheological properties of long chain branched polyethylene [17] showed that the viscosity increased at very low shear rate ($<0.05 \text{ s}^{-1}$) for high density of branches but decreased for high shear rate (between 10 and 600 s^{-1}).

The application of ultrasonic vibration in different molding processes is aimed to have a more accurate control of this process. An improved control of resin transfer molding process has been achieved [18]. A relation between ultrasound signal and packing stage of injection molding has been found [19], and a monitored blowing process during the curing cycle of sponge rubber has been developed [20].

Ultrasounds have been used in extrusion to analyze rheological and mechanical properties of different materials, *i.e.* polyethylenimine (PEI) [21], polyamide (PA) and polypropylene (PP) [15] comparing both mechanochemical and sonochemical methods, and to improve dispersion of nanoreinforcements into a polymeric matrix [22–24]. To optimize extrusion process conditions and obtain high purpose polymeric composites, it is important to characterize these rheological properties, that are related to dispersion state of the nanotubes, matrix orientation, and the interaction between nanotubes and polymeric chains [25].

Online testing of rheology at an industrial environment has been rarely used [26]. Online viscosity characterization is sometimes used for quality control of formulation batches [27]. An improvement of large parts quality is achieved by controlling viscosity during the injection process performed with a monitored nozzle [28]. The influence of recycled percentage used to inject a component

was analyzed by online viscosity measurement of the recycled material by means of a spiral mold [29–31]. Viscosity values online measured by an adjustable slit die have been compared to viscosity values obtained by conventional methods [32]. But, usually, biconical plate rheometers, rotational or capillary rheometers are usually used after the material is extruded.

In spite of the interest in the effects of ultrasounds on melt polymer, especially concerning rheological properties, investigation results are rarely transferred and scaled up to industrial applications. And hardly any research has been carried out to study the influence of ultrasounds on extrusion process productivity and efficiency specifically. This fact is mainly due to both technical and economic reasons, comprising the difficulty in obtaining a quick and enough efficient process, and the difficulty in testing the industrial process.

This article describes a further effort to understand the effects of ultrasonic waves on rheological properties, and how the efficiency of the process at industrial scale is improved. The study is based on a detailed analysis of the apparent viscosity, pressure and temperature evolution of ultrasonically treated samples of PE-HD, by means of an innovating fluidity measurement system working online with the extrusion process at real time. A new extrusion head including the ultrasonic system as well as the online viscosity measurement device is also designed and developed to carry out the experiments. This article is focused on understanding the ultrasounds aided extrusion in an industrial-scale extrusion-compounding machine and lays the foundations for a future one-step-process applied to nanocomposites production.

EXPERIMENTAL PART

Materials

The material used in this study was high density polyethylene (PE-HD) with trade name HMA 014 produced by ExxonMobil. The main properties of this material are listed in Table 1.

Table 1. Properties of PE-HD (ExxonMobil HMA 014)

Property	Value
Melt index	4 g/10 min (190 °C, 2.16 kg)
Density	0.960 g/cm ³
Melting temperature	135 °C
Flexural modulus	1050 MPa
Tensile strength at yield	25 MPa
Izod impact strength	11 J/m ²

Design of the extrusion head

The design of the extrusion die including an online viscosity measurement device for the fabrication of polymer extrusion plates is considered. It presents two main

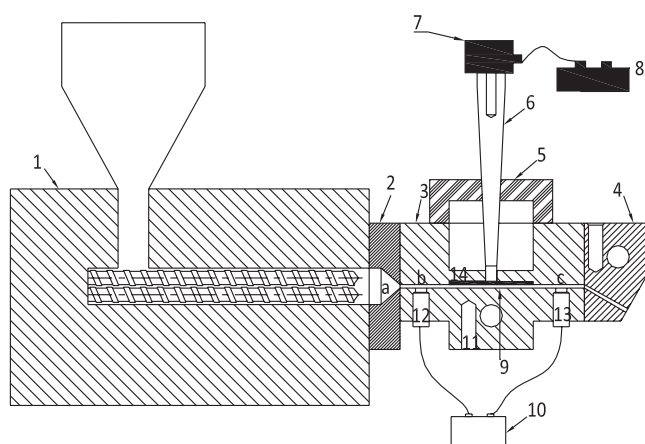

Fig. 1. The scheme of the designed extrusion head: 1 – extruder, 2 – coupling head, 3 – upper split case, 4 – die, 5 – sonotrode-transducer support, 6 – sonotrode, 7 – transducer, 8 – ultrasonic generator, 9 – rectangular profile channel, 10 – measurement chain, 11 – lower split case, 12 – sensor located before ultrasounds application area (b), 13 – sensor located after ultrasounds application area (c), 14 – separation sheet, a – location of the extrusion pressure sensor

novelties regarding other devices used to apply ultrasound vibration to a flow [33]. Firstly, an online measurement device is included to catch pressure and temperature of the flow at local areas just before and after the ultrasound application location. It provides online data about the flow which allows understanding its behavior. Secondly a thin separation sheet made of steel is located on the flow, in a way that ultrasounds are applied on it, and the vibration is transferred to the flow through it. It provides a wider distribution of the vibration to the flow. Description of the whole device is shown in Fig. 1.

The extrusion head contains a split case consisting of two sections, namely, upper (3) and lower (11). As a result of connection of rectangular sections (3) and (11) of the case, a rectangular profile (9) is formed whose dimensions are 2.5 mm thickness, 10 mm width and 120 mm length. These dimensions were established taking into account that drop of pressure suffered by the polymer when flowing through the die was suitable for the extruder.

On top of the profile channel (9), a separation sheet (14) with dimensions of 75 x 22 x 0.1 mm is placed to better distribute the oscillations through the flow, and to prevent polymer leaks. The profile channel (9) is connected to the feeding channel of the extruder (1) by means of a coupling head (2). In front of the case (3)–(11) a die outlet (4) is arranged to allow the continuous flow of the extrudate. The ultrasonic reactor consists of an ultrasonic generator (8), a transducer (7), and a sonotrode (6). The generator (8), that has a power supply of 2000 W and the frequency of 20 kHz, is connected to a transducer (7) needed to convert electrical signal into vibrations, and to a titanium sonotrode horn (6) which receives the vibration signal of 20 kHz from the transducer, and is in direct contact with the polymer melt at the profile channel (9)

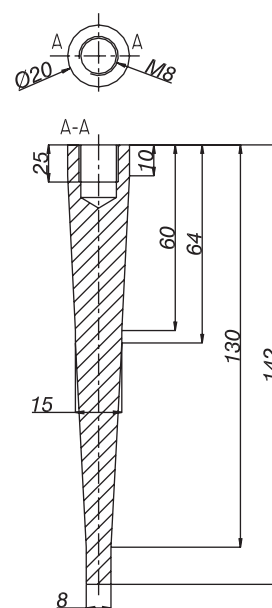

Fig. 2. Design of the sonotrode

through the separation sheet (14). The transducer (7) is cooled by two compressed air circuits and screwed to the sonotrode. The sonotrode (6) is designed with two criteria in mind:

- it should work at the resonance frequency of 20 kHz, the same as the generator and transducer;
- its diameter should be 8 mm to cover the whole die profile channel width presented in Fig. 2.

The sonotrode (6) provides longitudinal vibrations at the die central zone normal to the polymer flow.

A sonotrode-transducer support (5) is located on the upper half of the case, at the vibration node, as vibration in this point is zero. This point has been determined by means of a finite-element analysis at 62 mm from the upper side of the sonotrode.

The extruder (1) introduces material to the profile channel (9) through a designed nozzle at the coupling head (2) connecting the upper split case (3).

The online measurement rheology device consists of two sensors (Kistler 4021B), a temperature transducer, the corresponding amplifiers, and the system to control and monitor the signals. Kistler sensors work in the temperature range up to 350 °C, and a pressure range up to 3000 bar. They are placed in two separated points in the material flow, before (12) and after (13) the area where ultrasounds are applied. The distance between sensors is 100 mm. The distance from the ultrasounds application area to sensors is 50 mm. The sensors can be used for the simultaneous measurement of pressure and temperature. The die is also equipped with chain heaters controlled by thermocouples to control the temperature of the molten material. The sensors use a very stable and high temperature resistant silicon sensor element which operates according to the piezoresistive principle. These transducers are coupled with their charge amplifiers. To register the pressure values obtained by the sensors

during extrusion, a measurement chain (10) is necessary. Sensor wires are connected to an extension cable to reach the place where the measurement equipment is located. Each extension wire is connected to an amplifier, which is connected also to a control and monitoring system (CoMo system of Kistler). This unit allows acquisition and evaluation of signals from sensors with a PC.

Extruder and ultrasonic device

A co-rotating twin screw extruder (Coperion ZSK 26 Mc), presented in Fig. 3, with a maximum torque of 100 Nm; maximal screw speed $\omega_{max} = 1200$ rpm, screw diameter of 25 mm, and screw length to diameter ratio $L/D = 40$ was used in the different test procedures. PE-HD was fed into the extruder and the screw speed was set at $\omega = 500$ rpm and zone temperatures were set at 160/190/190/190/200/200/200/200 °C. A maximum pressure of 180 bars is allowed.

The ultrasounds device shown in Fig. 4 consists of a generator-PC featured as MPI Ultrasonics WG 20 kHz that is controlled by LabView software to create the signal and parameterize the process. A transducer MPI Ultrasonics 5020-6ps works at the frequency of 20 kHz and has the power of 1000 W. A sonotrode made of a titanium alloy Ti6Al4V, specially built for this purpose, was described previously.

The signal used for the test has the frequency of 20 kHz and amplitude of 12 μm . It was applied alternatively in periods of one minute to provide results with and without ultrasounds.

Tests description

A first set of tests was carried out to see the influence of the flow rate on the pressure and viscosity of the material. Different flow rates between 2 and 8 kg/h were tested. For all the cases, pressure and temperature values were measured at points before and after the ultrasounds

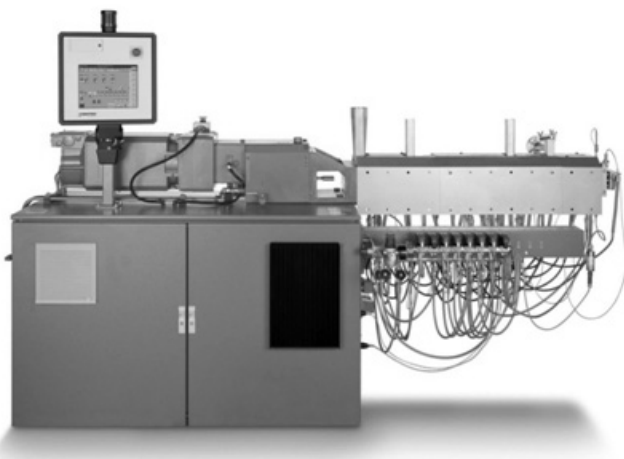

Fig. 3. Extruder Coperion ZSK 26 Mc used for experimental

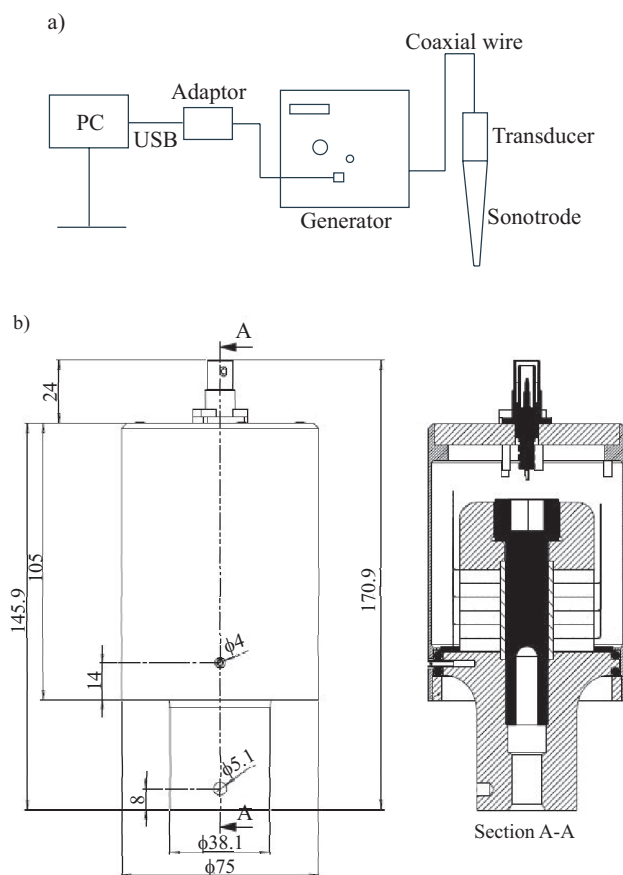

Fig. 4. Scheme of the ultrasounds device: a) block diagram, b) transducer

application area. These points are shown in Fig. 1 and are designated as: a (extruder), b (before ultrasounds application area) and c (after ultrasounds application area).

To analyze the process efficiency, there was carried out a new test at the maximum pressure allowed by the machine (130 bars). The flow rate was increased progressively with and without ultrasounds till the maximum pressure was reached. It was performed to appreciate an increase in the extrudate output while ultrasounds were applied.

All the tests were repeated ten times. Averaged values of the results are shown for all the trials.

Rheological calculations

The viscosity was determined using an equation that takes into account temperature, pressure and flow rate. The calculations were performed assuming that the melt was a Newtonian fluid and the following equation was fulfilled:

$$\eta_{ap} = \frac{\tau}{\dot{\gamma}_{ap}} \quad (1)$$

where: η_{ap} – apparent viscosity, τ – shear stress, $\dot{\gamma}_{ap}$ – apparent shear rate.

The η_{ap} was calculated from eq. (1), where the parameters involved τ and $\dot{\gamma}_{ap}$ are related to other process parameters such as pressure, flow rate and die geometry. Rabino-

witsch correction could be applied for true shear rate calculation, but it is not considered relevant for the purpose of this research because apparent viscosity is only calculated as a needed variable to understand the behavior of the processes influenced by ultrasounds application.

A shape factor (F_p) for relationship between volumetric flow rate in parallel-plate and volumetric flow rate in channel is used [1].

F_p takes into account the correction proposed for the relation between volume flow rate (Q) and pressure drop measured between two sensor locations (ΔP) for rectangular channels, given by equation:

$$Q = \frac{ba^3}{12\mu} \cdot \frac{\Delta P}{L} \cdot F_p \quad (2)$$

where: Q – volume melt flow rate (m^3/s), $a = 0.0025 m$ – height of rectangular section measurement channel, $b = 0.01 m$ – width of rectangular section measurement channel, $L = 0.1 m$ – distance between two sensors location where pressure drop is measured, $F_p = 0.83$ for the chosen geometry.

The apparent shear rate ($\dot{\gamma}_{ap}$) is calculated indirectly using the given value of F_p [29, 34]. If F_p values are smaller than 1, the two-dimensional geometry is assumed and the influence of this factor on $\dot{\gamma}_{ap}$ is taken into account increasingly:

$$\dot{\gamma}_{ap} = \frac{6Q}{a^2bF_p} \quad (3)$$

The wall shear stress (τ) is determined using equation:

$$\tau = [\Delta P / 2L][ab / (a + b)] \quad (4)$$

Traditionally, viscosity values are determined using capillary rheometer, where capillary diameter and lengths are known, and pressure drop between the beginning and the end of the capillary is measured. When using a capillary rheometer for viscosity determinations, Bagley correction is usually applied to get more accurate viscosity values. It is based on the assumption that the melt flow cross-section is constant through the capillary. This condition is not true at all because of the changes in cross-section along the capillary entrance and exit. These section changes generate pressure drops affecting the calculations of viscosity. When the pressure drop is determined by a monitored die, the polymer flows always into the slit, so there are not pressure drops due to flow section changes in areas near or between sensors locations. That is why Bagley correction is not necessary.

After using this correction, η_{ap} value of the polymer melt, given by eq. (1), can be calculated.

RESULTS AND DISCUSSION

Process pressure and temperature

The application of ultrasounds during extrusion affects greatly the material flow when it is processed. During the extrusion of PE-HD the pressure decreases gradually as the ultrasounds device is acting. This pressure

is measured by the sensors installed before and after the area where vibration is induced. The pressure decrease is partially due to an increment of temperature of the melt flow when ultrasounds are applied. A mechanical vibration is transmitted to the flow increasing the viscous shearing, which leads to an increment of temperature, and therefore to a decrease in viscosity. Another factor that has influence on the decrease in pressure and viscosity is the thixotropic nature of pseudoplastic materials like molten polymers. This nature allows vibration wave propagation to cause a fluidification of the melt. Some other effects related to cavitation seem to have influence also on the pressure and viscosity decrease [7, 9, 23]. On the other hand, the reduction of elongational flow due to the polymer vibration reduces the pressure loss along the die channel and the extrudate swell at the die exit.

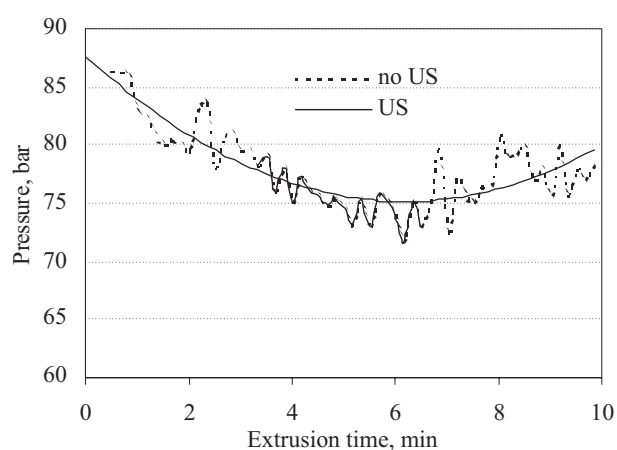

Fig. 5. Extrusion pressure with US and without ultrasounds (no US) application, along the time for extrusion with flow rate of 3 kg/h

The evolution of the pressure in time for the case of samples obtained using melt flow rate of 3 kg/h is presented in Fig. 5. The previously described effect of the reduction of pressure when ultrasounds are applied is shown. Another fact that can be observed is that when the application of ultrasounds finishes, the pressure is slightly recovered, by about 5%. This evolution has been revealed for all processing conditions in this article.

Fig. 6 shows the effect of ultrasounds on the temperature. T_{s1} curve corresponding to the temperature of the melt before the ultrasounds application area and T_{s2} to the temperature after the area. T_{s1} increases by about 2 °C along in for all the flow rates tested, while T_{s2} increases by up to 3 °C when ultrasounds are applied. Once ultrasounds are interrupted the temperature recovers values previous to ultrasounds application. The values of temperature shown in Fig. 6 were acquired with an accuracy of ± 0.05 °C. The vibrational energy for unit area was $I = Af^2x^2$ [17] and it increased with the density and propagation velocity of the material, the frequency and amplitude of

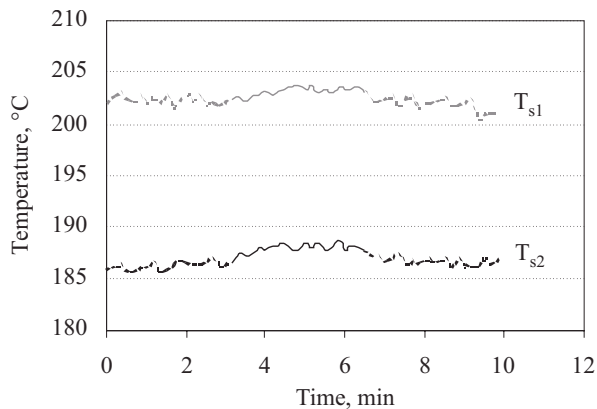

Fig. 6. Flow temperature with ultrasounds (US – continuous line) and without ultrasounds (no US – dotted line), downstream (T_{s2}) and upstream (T_{s1}) from the application area for extrusion with flow rate of 3 kg/h

the vibration. The effect of energy on the material and the rate constant of chemical reactions (k) follow the Arrhenius equation:

$$k = Ae^{\frac{E_a}{RT}} \quad (5)$$

where: E_a – activation energy.

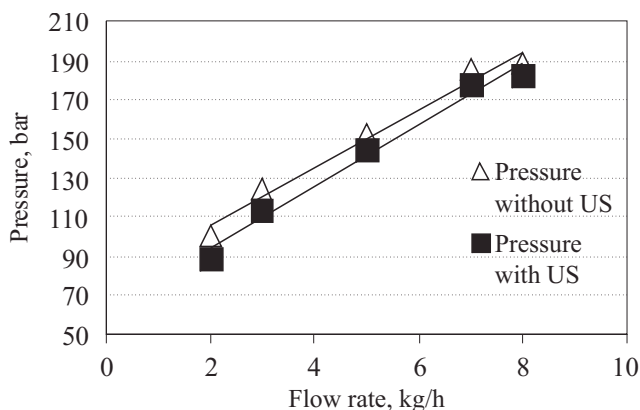

Fig. 7. Pressure dependence on flow rate measured just before the ultrasounds (US) application area

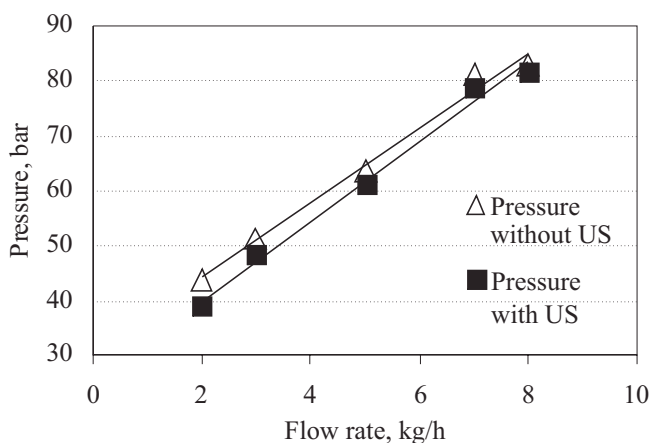

Fig. 8. Pressure dependence on flow rate measured just after the ultrasounds (US) application area

Figs. 7 and 8 show averaged values of pressure measurements in the flow just before and after the area where ultrasounds are applied, respectively. These values have been extracted from the information registered by the sensors in time (Fig. 5) after post-processing of the data to determine average values. In these cases, the same tendency of pressure decrease when ultrasounds were not applied was observed. Again, the lower flow rate, the higher was the pressure decrease. Pressure variations downstream range from 11 % for low flow rates to 3 % for high flow rates, and variations upstream reach 11 % for low rates and 1 % for high ones.

Extrudate output

Ultrasonic vibration during extrusion affects the throughput of the extrudate. To analyze this influence the following methodology was followed: a machine maximum pressure was fixed at 130 bar, that is to say, if machine sensor pressure detects 130 bar during the processing, it stops working for safety reasons. The goal of this test is to determine the maximum flow rate allowed by the extruder without reaching the security maximum pressure. Tests will be carried out both with and without applying ultrasounds. Fig. 9 shows how the flow rate of

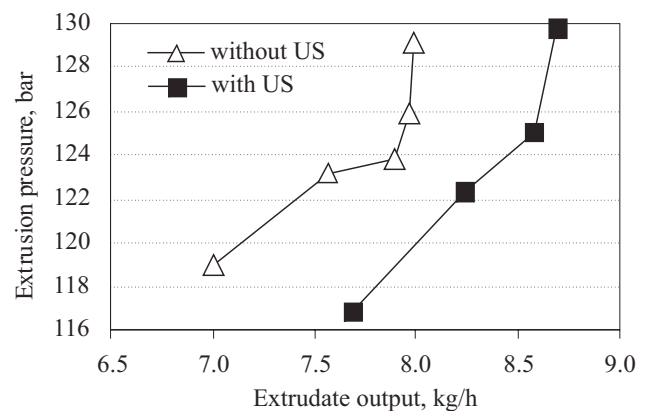

Fig. 9. Maximum flow rate reached by the extruder with and without ultrasounds (US) application under limit pressure conditions of 130 bar

8.7 kg/h is reachable applying ultrasounds while a lower flow rate of 8 kg/h is reachable if ultrasounds are not applied. So, the productivity and efficiency of the process can be improved by 10 % thanks to ultrasounds actuation.

Viscosity

For results obtained in this study 5–10 % reduction of η_{ap} is reached when ultrasounds are used, following the same trend as for the process pressure, that is to say, a higher reduction for lower flow rates. Table 2 shows the obtained results. The reduction of η_{ap} is due to the incre-

ment in temperature, the variations in shear rate, velocity profile and the physical and chemical changes of the molten polymer. The viscosity is influenced also by the potential chain branching of the PE-HD due to thermo-mechanical degradation under ultrasonic waves.

Table 2. Apparent viscosity (η_{ap}) values for samples obtained in various conditions

Ultrasounds application	Flow rate kg/h	$\dot{\gamma}_{ap}$, 1/s	ΔP , bar	η_{ap} , Pa · s
No	2	62	51	817
Yes	2	62	47	752
No	3	94	72	765
Yes	3	94	66	701
No	5	156	101	645
Yes	5	156	95	610
No	7	219	97	441
Yes	7	219	96	437
No	8	250	102	409
Yes	8	250	100	398

CONCLUSIONS

A new ultrasound assisted extrusion process was developed for manufacturing PE-HD. This new system provides some advantages, such as reduction in the die pressure that causes a reduction in the apparent viscosity, and a higher extrudate output.

Pressure reduction is more important when low flow rates are used. Pressure decrease ranges from 4 to 16 % at the extruder die depending of the flow rate tested. Higher reductions are reached for low rates. Material pressure at the area before ultrasounds application is reduced by between 3 and 12 % obtaining higher reductions for low flow rates. Material pressure at the area just after ultrasounds application is reduced by up to 11 % for low flow rates and hardly 1 % high flow rates.

This behavior is due to different factors. The physical and chemical changes induced by ultrasonic vibration produce a reduction in apparent viscosity of the material by from 5 to 10 %, obtaining higher reductions for lower flow rates. The vibration energy transmitted to the molten polymer increases its temperature slightly. The thixotropic effects due to temporal molecular movements decrease the viscosity. The reduction of elongational flow due to the polymer vibration reduces the pressure loss along the die channel and the extrudate swell at the die exit. Finally, the intensity of vibrational energy is so high that it induces permanent changes in the polymer due to thermomechanical degradation. This mechanism of degradation could induce branching in the case of PE-HD with an improvement of its shear thinning behavior [9, 24].

Thanks to this pressure reduction, this new processing system can be applied in different circumstances,

where high extrusion pressure is required such as extrusion of nanocomposites or blend materials. The improvement of immiscible materials compatibilization or micro and nano reinforcement dispersion could be possible with a one-step-process ultrasounds aided extrusion.

Also, ultrasounds increase the extrusion throughput without change to any process parameter when the extrusion machine limits are near to be reached. The cost of products could be cut significantly if a faster process is designed to increase the output by reducing the die-head pressure during the extrusion. This research allows to conclude that an increment in the process efficiency by 10 % can be reached.

ACKNOWLEDGMENTS

The authors thank the Spanish Government for the financial support through the ULTREX-PID-600100-2009-13 project.

REFERENCES

- [1] Tadmor Z., Gogos C.G.: "Principles of Polymer Processing", John Wiley & Sons, 1979, p. 736. <http://dx.doi.org/10.1002/aic.690260135>
- [2] Sikora J.W., Kapusniak T.: *Polimery* **2005**, 50, 748.
- [3] Sasimowski E., Sikora J.W., Krolkowski B.: *Polimery* **2014**, 59, 505. <http://dx.doi.org/10.14314/polimery.2014.505>
- [4] Sakai T.: *Polimery* **2013**, 58, 847. <http://dx.doi.org/10.14314/polimery.2013.847>
- [5] Sarasa J., Gracia J.M., Javierre C.: *Bioresource Technol.* **2009**, 100, 3764. <http://dx.doi.org/10.1016/j.biortech.2008.11.049>
- [6] Ganster J., Erdmann J., Fink H.P.: *Polimery* **2013**, 58, 423. <http://dx.doi.org/10.14314/polimery.2013.423>
- [7] Fernández A., Muniesa M., Javierre C., Camanes V.: *Adv. Mat. Res.* **2012**, 445, 313. <http://dx.doi.org/10.4028/scientific5/amr.445.313>
- [8] Fernández A., Muniesa M., González J.: *J. Mech. Eng.* **2013**, 59, 183. <http://dx.doi.org/10.5545/sv-jme.2012.417>
- [9] Chen J., Chen Y., Li H. et al.: *Ultrasonics Sonochemistry* **2010**, 17, 66. <http://dx.doi.org/10.1016/j.ultsonch.2009.05.005>
- [10] Price G.J.: "New methods of polymer synthesis" (Eds. Ebdon J.R., Eastmond G.C.), London Chapman & Hall, 1995, Vol. 2. <http://dx.doi.org/10.1007/978-94-011-0607-8>
- [11] Margulis M.A.: "Sonochemistry and Cavitation", Gordon and Breach Science Publishers SA, 1995.
- [12] Isayev A.I., Wong C.M., Zeng X.: *Adv. Pol. Tech.* **1990**, 10, 31. <http://dx.doi.org/10.1002/adv.1990.060100104>
- [13] Isayev A.I., Hong C.K.: *Polym. Eng. Sci.* **2003**, 43, 91. <http://dx.doi.org/10.1002/pen.10008>
- [14] Isayev A.I., Hong C.K., Kim K.J.: *Rubber Chem. Technol.* **2003**, 76, 923. <http://dx.doi.org/10.5254/1.3547782>
- [15] Lin H., Isayev A.I.: *J. Appl. Polym. Sci.* **2006**, 102, 2643. <http://dx.doi.org/10.1002/app.24057>
- [16] Feng W., Isayev A.I.: *Polymer* **2004**, 45, 1207. <http://dx.doi.org/10.1016/j.polymer.2003.12.033>
- [17] Yan D., Wang W.J., Zhu S.: *Polymer* **1999**, 40, 1737. [http://dx.doi.org/10.1016/s0032-3861\(98\)00318-8](http://dx.doi.org/10.1016/s0032-3861(98)00318-8)

- [18] Schmachtenberg E., Schulte zur Heide J., Töpker J.: *Polym. Test.* **2005**, 24, 330. <http://dx.doi.org/10.1016/j.polymertesting.2004.11.002>
- [19] Michaeli W., Starke C.: *Polym. Test.* **2005**, 24, 205. <http://dx.doi.org/10.1016/j.polymertesting.2004.08.009>
- [20] Datta D., Kirchhoff J., Mewes D. et al.: *Polym. Test.* **2002**, 21, 209. [http://dx.doi.org/10.1016/s0142-9418\(01\)00072-1](http://dx.doi.org/10.1016/s0142-9418(01)00072-1)
- [21] Isayev A.I., Kumar R., Lewis T.M.: *Polymer* **2009**, 50, 250. <http://dx.doi.org/10.1016/j.polymer.2008.10.052>
- [22] Smith G.D., Brown E.C., Barnwell D. et al.: *Plast. Rubber Compos.* **2003**, 32, 167. <http://dx.doi.org/10.1179/146580103225002759>
- [23] Blanco M., Sarasua J.A., López M. et al.: "Ultrasound assisted extrusion of polyamide 6 nanocomposites based on carbon nanotubes" from Macromolecular Symposia 321–322, 2012, p. 80.
- [24] Muniesa M., García L., Castell P. et al.: *Mater. Res. Innov.* **2014**, 18, 85. <http://dx.doi.org/10.1179/1432891714z.000000000386>
- [25] Wang M., Wang W., Liu T., Zhang W.D.: *Compos. Sci. Technol.* **2008**, 68, 2498. <http://dx.doi.org/10.1016/j.compscitech.2008.05.002>
- [26] Klozinski A., Sterzynski T.: *Polimery* **2005**, 50, 455.
- [27] Alig I., Steinhoff B., Lellinger D.: *Meas. Sci. Technol.* **2010**, 21, 062001. <http://dx.doi.org/10.1088/0957-0233/21/6/062001>
- [28] Fernández A., Mercado D., Javierre C., Muniesa M.: *J. Mech. Eng.* **2008**, 54, 258.
- [29] Javierre C., Clavería I., Ponz L., Aísa J., Fernández A.: *Waste Manage* **2007**, 27, 656. <http://dx.doi.org/10.1016/j.wasman.2006.03.005>
- [30] *Pat. Spain* 2 263 377 (2006).
- [31] Muniesa M., Fernández A., Javierre C.: *Polym. Test.* **2014**, 3, 107. <http://dx.doi.org/10.1016/j.polymertesting.2013.11.008>
- [32] Aho J., Syrjalä S.: *Polym. Test.* **2011**, 30, 595. <http://dx.doi.org/10.1016/j.polymertesting.2011.04.014>
- [33] *Pat. WO* 2004024415A1 (2002).
- [34] Friesenbichler W., Duretek I., Rajganes J., Kumar S.R.: *Polimery* **2011**, 56, 58.

Received 27 V 2014.

Instytut Chemii Przemysłowej im. prof. I. Mościckiego w Warszawie

opracował ogólnokrajową

BAZĘ APARATURY DO OKREŚLANIA CHARAKTERYSTYKI I PRZETWÓRSTWA POLIMERÓW

będącej w posiadaniu uczelni, instytutów PAN i instytutów badawczych.

Baza jest wyposażona w funkcje umożliwiające wyszukiwanie wg zadanych parametrów: nazwy, typu lub modelu aparatu, roku produkcji, producenta, charakterystyki parametrów technicznych, zastosowania do badań, lokalizacji, słów kluczowych, sposobu wykonywania badań, numerów norm, wg których prowadzi się badania, oraz adresu i kontaktu z osobą odpowiedzialną za dany aparat. Baza jest ciągle uaktualniana.

Dostęp do danych i wyszukiwanie informacji w bazie jest bezpłatne.

Instytucje i firmy zainteresowane zamieszczeniem w bazie informacji o posiadanej aparaturze prosimy o przesłanie danych na adres polimery@ichp.pl

aparaturapolimery.ichp.pl