

Jacek Karczewski

Institute of Power Engineering, Department of Thermal Technology "ITC" in Łódź
ul. Dąbrowskiego 113, 93-208 Łódź, jacek.karczewski@itc.edu.pl

TRANSFER OF SCIENTIFIC RESEARCH RESULTS TO PRACTICE - CASE STUDY OF INNOVATIVE SOLUTIONS WHICH HAVE BEEN IMPLEMENTED IN ENERGETICS

Abstract

The article presents the experiences of the "ITC" Heat Engineering Department in Łódź of the Energy Institute in implementing innovative solutions in the field of power engineering. The process of commercialization of scientific research results is described. Based on the example of the electro-hydraulic power regulator, developed in ITC and implemented in one of the professional power plants, which put into operation innovative solutions resulting from scientific research, the individual stages of knowledge transfer to the economy are presented. The structure, composition and functions of the regulator are discussed, as well as the results of object-oriented research, which prove the correctness of its operation and the validity of the adopted solutions. Examples of the benefits of the implementation of regulators are provided, exemplifying good practice in the area of cooperation between industry and research facilities.

Key words

Energetics, commercialization, innovations, steam condensation turbine, control system, optimization

Introduction

One of the priorities of Poland's scientific policy is to bring about a situation where innovative solutions developed in scientific and research centers will be implemented in industry, contributing to the development of particular sectors of the national economy [1]. The aim is to ensure that cooperation between science and business is based on two basic principles:

- The conduct of scientific work should respond to real economic demand. Science should solve real problems in industry, taking into account specific conditions and specificities of work of particular technological systems.
- Innovative solutions developed in universities and scientific institutes should be quickly absorbed by industry and implemented in the economy.

Therefore, the essence of scientific work should not be the creation of purely scientific studies; on the contrary, it should be the result of close cooperation between industry and science. This is supported by, among others, the policy of awarding various types of research grants, which aims to create consortia of scientific representatives and entrepreneurs; the latter should participate in the process of financing research. In a way, this forces research to be focused on specific needs.

The Institute of Energy, which is a continuation of the Institute of Heat Technology in Łódź, operating between 1948 and 2008, has always followed the principle of utilitarian research in its 65 years of activity [2]. The establishment of the Institute, in 1948, was connected with the solution of two specific problems set before scientists: the development of steam prototypes of a tractor for agriculture and an experimental gas turbine of 1000 kW. (Fig. 1)

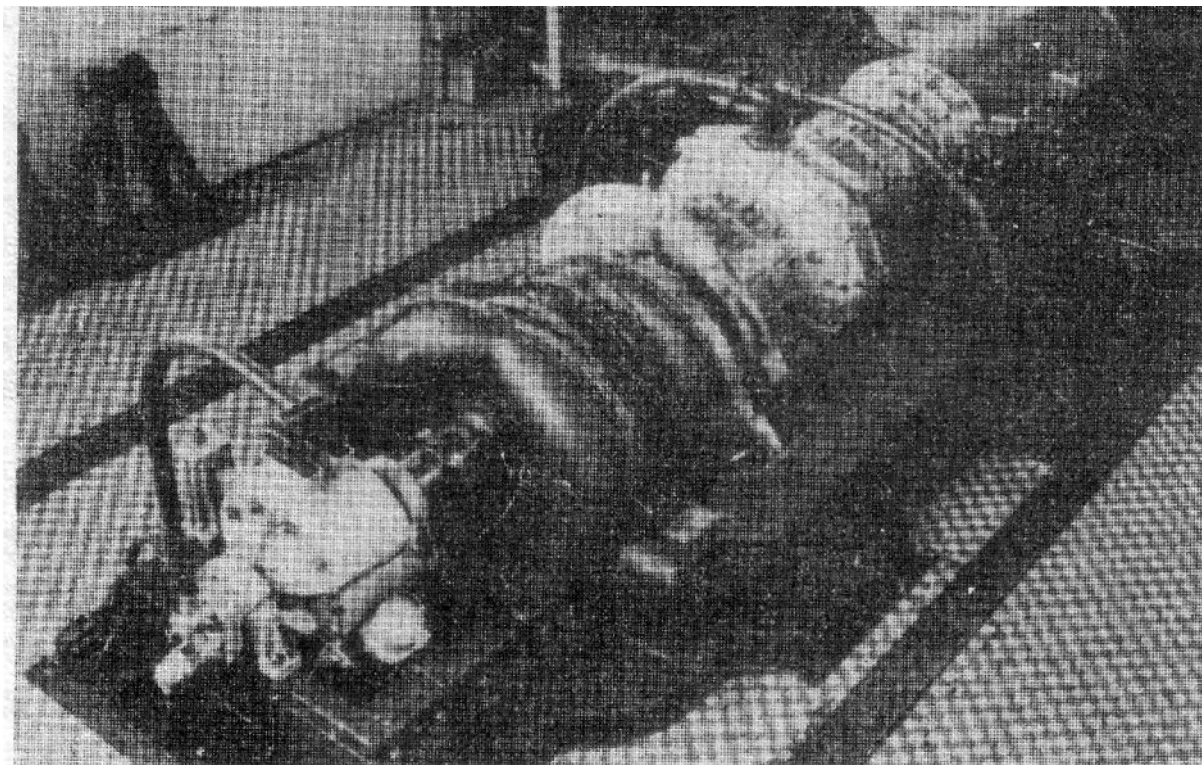

Fig. 1 Experimental gas turbine with a capacity of 1000kW constructed in the 1950s at the Institute of Heat Technology in Łódź.

Source: own study

In the context of the subject matter of this article, it is worth following the fate of one of these projects. The 1000 kW gas turbine was made at the Cegielski Plant in Poznań and located on the premises of the laboratory at the University of Technology in Łódź. The auxiliaries, system and control elements, as well as the well-equipped measuring station, were made independently by ITC. In 1958, the engine room was put into operation on a trial basis, and during the next three years numerous tests were carried out on the building, gaining knowledge and experience. However, due to the lack of further interest in the development of gas turbines at that time in the power engineering department, the works were abandoned. Similarly, this was the case with other areas developed at the Institute. In the 1970s, the Nuclear Power Plant, with more than 70 people, operated, which developed much innovative equipment for primary and secondary nuclear power plants (steam generators, heat exchangers, pressure stabilizers). Here too, the scientific work and technologies developed were not used. Of course, there are many examples in which prototype solutions, invented by the ITC scientific staff, have been implemented by industry. Examples include, for example, steam blowers for cleaning the heating surfaces of boilers, steam heat meters, fans and blowers for a wide range of industrial and energy applications, steam blowers and many more. The following part of the article will describe the field of activity of ITC, which is an example of knowledge transfer for practical applications.

Commercialization of research (from idea to implementation)

Fig. 2 presents the structure of revenues of the Heat Technology Division of the Energy Institute.

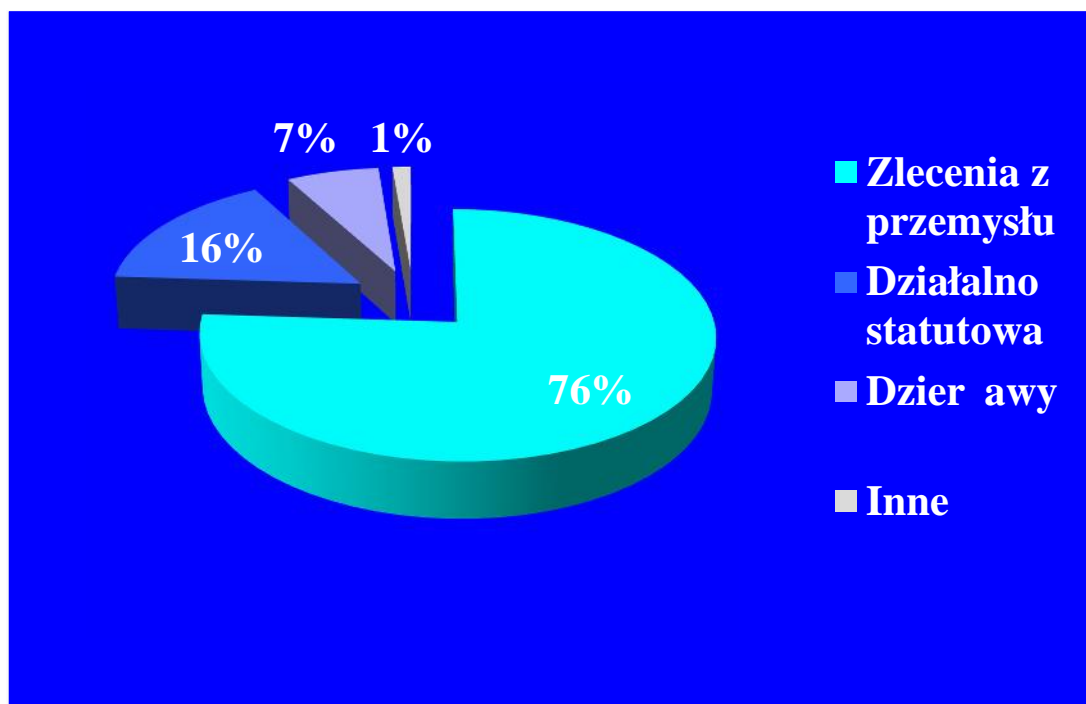

Fig. 2 Structure of income of a typical research institute.

Source: own study

The vast majority of the work is carried out by industry. In other words, the Institute must attract customers because they are the primary source of income. Without market intelligence (i.e. knowledge possession) on the real energy needs) it would not be possible to carry out research activities. It is therefore very important to have the permanent presence of scientists in power plants and to learn about the problems encountered, e.g. during operation of the power plant system. On the other hand, it is important to be able to convince potential investors to take up the challenges connected with the implementation of innovative solutions. The test team must be flexible to cope with these tasks. That is why it is so important to use the budget for the statutory activities of the research and development unit wisely and rationally. The following criteria should be taken into account when selecting the themes to be pursued in the context of the statutory activity:

- The material value of the proposed topic (innovativeness, new character, cognitive value),
- Relationship to the subject matter of conducting research, as laid down in the Institute's Articles of Association,
- Reference to existing knowledge about the subject of the work,
- Experience of the Institute's (laboratory) plant and direct head of work in the field covered by the Articles of Association concerns,
- Utilitarian character of work (possibility of using results of work for practical applications),
- Possibility of extending the Institute's activities to include new areas of research,
- Possibility of extending the scope of accreditation of the Institute's laboratories,
- Possibility of gaining experience, which will be used later - in the course of commercial works,
- Possibility of "finalizing" the acquired knowledge (publications, participation in conferences, promotion of the Institute),
- Possibility of using the research as a basis for submitting applications for a grant, targeted at a development project ("grant for grant"),
- Possibility of using research in the Institute's doctoral and habilitation studies (e.g. material used to open a doctoral thesis),
- Possibility of establishing cooperation with leading scientific centers in Poland and abroad; possibility of conducting joint research by various organizational units (scientific and research facilities, laboratories) of the Institute,
- Possibility of expanding and renewing the laboratory and equipment base,
- Continuation of the statutory subject matter from previous years in order to expand the acquired knowledge.

The most important element of the process “from idea to implementation” is continuous cooperation between science and industry. This may concern, for example, the provision of a facility (energy block) for testing and prototype testing. Ongoing consultations and working meetings are essential. Fig. 3 shows a diagram of dealing with research results during commercialization. Cooperation: science-industry, though with varying intensity, should take place at every stage of work.



Fig. 3 Diagram of dealing with research results during commercialization.

Source: own study

The following is an example of an ITC project developed and implemented at one of the power plants of the MREH electro-hydraulic power regulator, which implements innovative solutions resulting from scientific investigations carried out in accordance with the above scheme.

Electric-hydraulic turbine adjustment

A microprocessor-operated, electro-hydraulic power regulator (MREH) was designed and manufactured at the ITC Heat Engineering Division of the Energy Institute in Łódź and implemented at the Adamów Power Plant[3]. This power plant participates in the primary, secondary and triple Polish power system regulation [4,5]. The frequency and power control system is a hierarchical control system with several control levels [4,6] (Fig. 4).

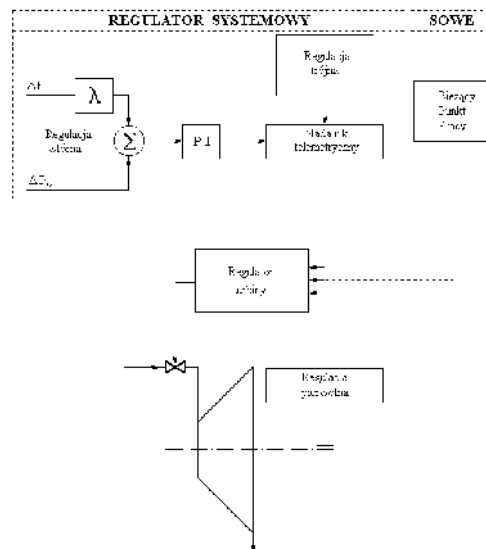

Fig. 4 Regulatory levels in the power system.

Reference: own study based on materials of PSE SA

The first step, called the primary regulation, is the turbine speed regulators. The original regulation is decentralized, as it is implemented by the turbine regulation systems in individual power plants. Step two is the

- Communication capabilities with central visualization systems.

The view of the controller installed in the power plant is shown in Figure 6 and the synoptic diagram of the controller's control panel is shown in Figure 7.

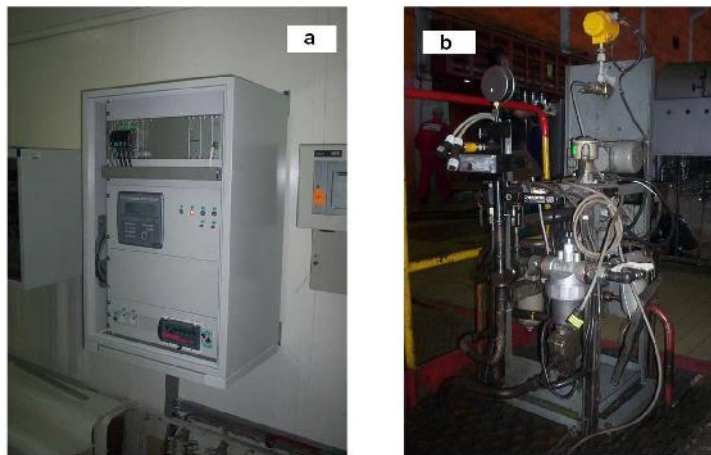

Fig. 6. Electro-hydraulic power controller. a - central part, b – electro-hydraulic transducer
Source: Author's own study.

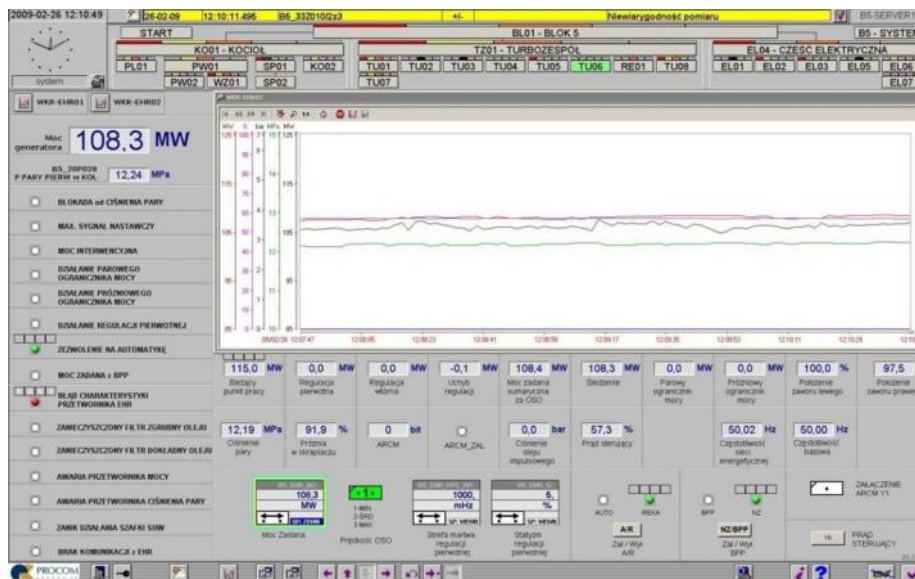

Fig. 7. Synoptic diagram of the controller
Source: Author's own study.

The MREH regulator uses innovative solutions, such as on the connection of control systems: power and steam pressure in the auxiliary boiler with signals, whose task is to prevent sudden changes in vapor pressure during overturning of the turbine control valves [8]. The research carried out consisted in searching for such auxiliary signals in the REH regulator structure, which when introduced into the automatic pressure control system (UAR) would inform the boiler in advance about the intended change of power output. In order to assess the influence of auxiliary signals on the operation of the power unit, tests were carried out on selected 120 MW power units. The tests consisted of recording the pressure circuit response to interference on the power side, in the absence of auxiliary signals and after coupling both control systems. The disturbances were made with

different sizes and speeds of power changes. For example, Fig. 8 shows a comparison of selected waveforms for the same power changes for the non-coupled system and the auxiliary signal Y_n (power amplitude signal and output signal in the load regulator load limiter (OSO) of the power regulator). In the absence of auxiliary signals, the maximum amplitude of the pressure change was 0.43MPa. After entering the correction signal, it decreased to 0.24MPa. The introduction of the correction signal Y_n generated by the MREH regulator results in a reduction in pressure fluctuation of approximately 45%. (Fig. 8). This is proof of the correctness of the proposed solution. This issue is particularly important for biomass co-firing units [8].

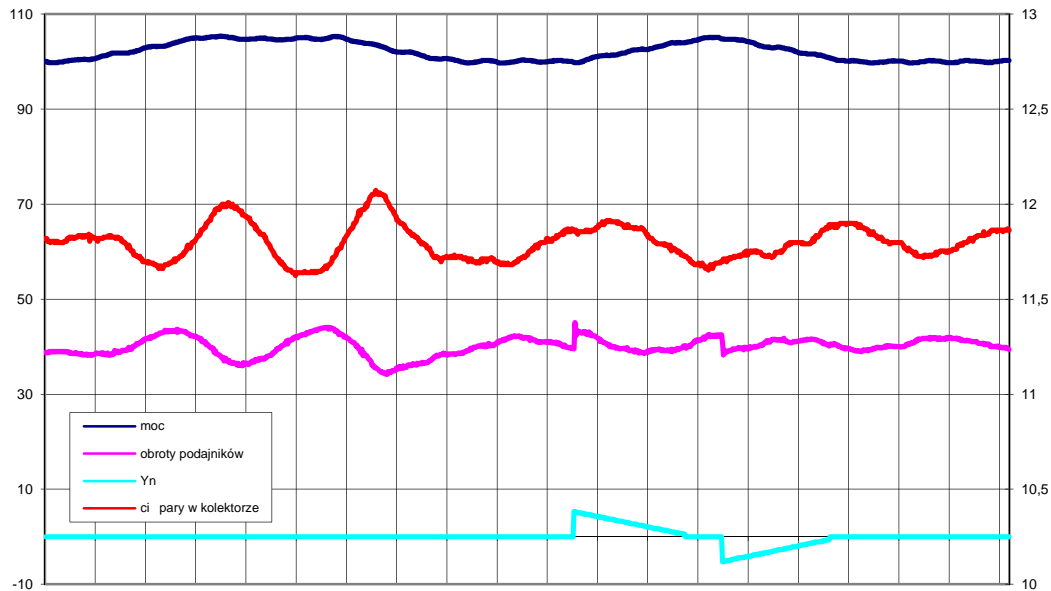

Fig. 8. Comparison of the fresh steam pressure after power circuit disruption for non-coupled systems and the introduction of the Y_{Nz} correction signal generated in the MREH regulator

Source: own study

As mentioned above, the turbines involved in the regulation of the power system must meet the strict quality control requirements (dynamics and statics). Periodically, they are carried out in block-testing power plants, commissioned by PSE, by an independent company, on the basis of which the turbochargers work and their suitability for system regulation. The results of this assessment will determine whether the system services will be purchased from the power plants by PSE. In other words, the positive reception of a unit's work translates directly into additional revenue for the unit. Examples of waveforms recorded during MREH regulator acceptance tests are shown in Fig. 9 [9]. During the study, simulations of power changes in the control range (80 ÷ 120 MW) were done, and the response of the block to these changes was checked. Figure 9 shows the response of the block to the forcing which is the result of the interaction of primary and secondary control. 6 MW power spikes were caused by a 100 MHz frequency change. The dynamics are correct (steady state is reached after $t < 30s$). A small oversupply does not exceed 1.2 MW. The impulse oil pressure of the regulator is proportional to the value of the central control signal of the MREH. Both control valves (left and right) smoothly override, force the change of their position and the value of the impulse oil pressure, without delays or overshoots. The presented results of field tests prove the correctness of MREH regulator operation.

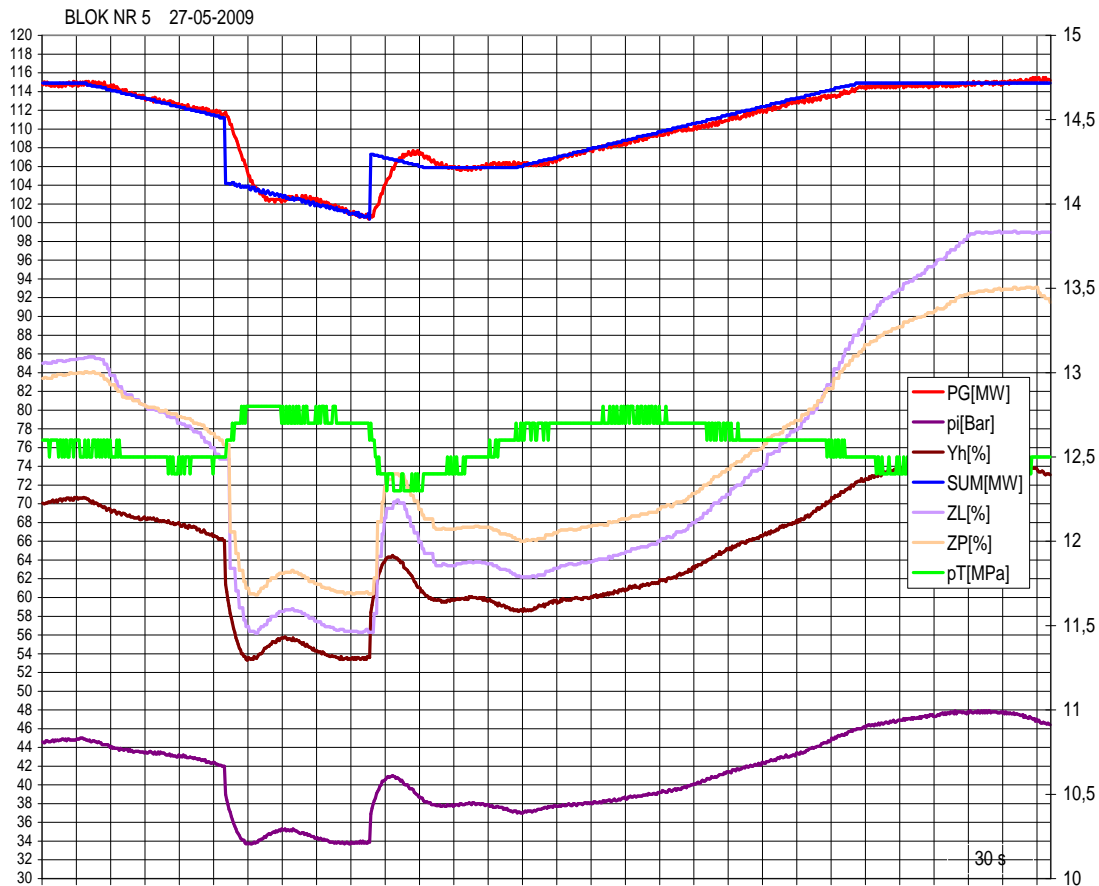

Fig. 9. MREH object-oriented research

List of indications: P_i [MW] - power of the generator, p_i [Bar] - pressure of the regulator opening oil, Y_h [%] - control signal of the regulator, SUM [MW] - total set power (according to the OSO Load Speed Limit), p_T [MPa] pressure of fresh steam from the boiler, Z_L [%] position of the left WP valve, Z_P [%] position of the right WP valve

Source: own study

It is worth emphasizing that the MREH regulator described above is a result of many years of scientific research in the field of electro-hydraulic regulation. In ITC, several generations of such regulators have already been built. In addition to the classic functions, they introduced solutions resulting from many years of scientific work. Thanks to this, we managed to implement the aforementioned system, which stabilizes the fresh steam pressure from the boiler during power fluctuations caused by the overloading of the control valves or the block diagnostics using artificial neural network technology, consequently providing analytical redundancy of the controller's measuring lines. This significantly facilitates the operation of a large power unit and brings benefits to the plant. It should also be stressed that the effect of this work would not have been possible had it not been for the cooperation of ITC researchers with the power station employees. Thanks to their substantive involvement, numerous scientific ideas could be realized, and verified solutions adopted. It is invaluable in this case to know what you can obtain from energy practitioners. Total implementation of electro-hydraulic power regulators resulted in:

- Extending knowledge from the field (conducting various simulations, creating mathematical models of objects, analyzing physical phenomena occurring during boiler and turbine thermal processes, carrying out numerous experimental studies in laboratory and field conditions, etc.).
- Improving working conditions and increasing the certainty of the traffic of the blocks involved in the regulation of the power system
- Economic effects (for power plants: fees for the supply of system services, for the Institute: sales of licenses for patented solutions)
- Awards and distinctions (awarded to the Institute in 2010 the title of Innovation Leader of the Łódź Region in a competition announced by the Marshal of the Łódź Region, "Success Key" award and others).

Conclusion

The issues presented in the article are utilitarian. These solutions have been implemented in the power industry and bring measurable results to investors. Thanks to the knowledge and experience of the ITC researchers, the industry has proposed a novel, innovative solution that will contribute to improving traffic reliability and improves the operating conditions of power units involved in regulating the power system. In a direct way, this translates into the quality of work of the entire power system of Poland. The success of the solution was achieved through close cooperation between the Institute and the power plant. While developing the assumptions for the project, the flexibility of the research team was very important, so that the Institute could address the problems that the professional energy industry is facing every day. Apart from utilitarian meaning, the work was cognitive and scientific. It has resulted in patent applications, scientific publications (two doctoral dissertations using research results have been defended), papers presented at conferences, etc. It should be emphasized clearly that the schema presented in Fig. 3 was fully implemented, which contributed to the final success. There are numerous awards and recognitions of this success, but above all the satisfaction of the power plant and the willingness to cooperate further with the Institute. The work is therefore an excellent example of the commercialization of scientific research results and good cooperation of the professional energy industry with its scientific background.

Literature

- [1] J. Karczewski, Aby innowacje pobudzały rozwój gospodarki, *Energetyka Ciepła i Zawodowa* no. 9 (2011), pp. 12-15
- [2] 60 lat Instytutu Techniki Ciepłej w Łodzi 2008, Wydawnictwo okolicznościowe ITC.
- [3] J. Karczewski, M. Pawlak, Regulacja elektrohydrauliczna mocy bloków 120 MW w Elektrowni Adamów – wdrożone rozwiązania, *Energetyka Ciepła i Zawodowa* no. 5 (2008), pp. 86-89
- [4] J. Machowski, Regulacja i stabilność systemu elektroenergetycznego, Oficyna Wydawnicza Politechniki Warszawskiej, Warsaw, 2007
- [5] M. Pawlik, F. Strzelczyk, *Elektrownie*, WNT, Warsaw, 2009
- [6] J. Karczewski, M. Pawlak, P. Szuman, P. Wąsik, Availability assessment of power units participating in electrical power system control, *Archives of energetic*, no. 1-2, (2010), pp. 89-103
- [7] J. Karczewski, M. Pawlak, Struktura UAR turbiny kondensacyjnej biorącej udział w regulacji krajowego systemu elektroenergetycznego, *Prace Naukowe Politechniki Warszawskiej, series Conferences*, book 24 (2005) pp. 153-162
- [8] J. Karczewski, Optymalizacja układów regulacji mocy i ciśnienia pary świeżej bloku energetycznego współspalającego biomasę, *Turbomachinery* no. 138, (2010) pp. 59-68
- [9] J. Karczewski, M. Pawlak, Weryfikacja poprawności działania elektrohydraulicznego regulatora mocy turbiny kondensacyjnej biorącej udział w regulacji systemu elektroenergetycznego, *Wiadomości Elektrotechniczne* no. 1 (2014), pp. 34-37