

Research Article

Open Access

Paweł Ciężkowski, Jan Maciejewski, Sebastian Bąk, Arkadiusz Kwaśniewski

Application of The New Shape Crushing Plate in Machine Crushing Processes

<https://doi.org/10.2478/sgem-2019-0029>

received March 7, 2019; accepted September 18, 2019.

Abstract: The results of studies of the crushing process in a double toggle jaw crusher are presented. This process was carried out on six sets of crushing plates. The first three of them are used in industrial crushers – plates with a flat working surface and a triangular profile (in this work, under consideration were profiles with teeth angle $\gamma = 90^\circ$). The fourth and fifth type refer to plates with a variable pitch t and teeth height with a triangular shape of the teeth. In the sixth solution, plates with variable pitch and width of the wedged teeth are proposed.

The results of the basic process parameters are shown, that is, average degree of fineness n , technical performance W_t , crushing energy L and crushing force F , sieve analysis of crushing product. The obtained results are the basis for the assessment of the suitability of various types of plates, especially plates with a new profile, which have an altered shape in comparison with the plates used in crushers so far.

The crushing tests were carried out with the same dimension of outlet slot $e_r = 24$ mm, close to the pitch size for plates with triangular profile. Tests were performed on the “Mucharz” sandstone. Samples from a series of blocks of different size and geometric shape were prepared. This work also presents feed mass influence on crushing process efficiency.

The plates with variable pitch and width of teeth are beneficial because of lower crushing force and energy.

Keywords: Double-toggle jaw crusher, crushing process, crushing plate, technical performance

List of abbreviations and symbols

n	Average degree of fineness
W_t	Technical performance
L	Crushing energy
L_s	Specific energy
F	Crushing force
F_{peak}	Maximum crushing force
$\bar{F}_{av,max}$	Average maximum crushing force
\bar{F}_{av}	Average crushing force
e_r	Dimension of outlet slot
t	Pitch, distance between teeth
t_{opt}	Optimal pitch
w	Teeth height
a	Crushing stamp width
a_{opt}	Optimal width of stamps
b	Width of the bottom of teeth
d	Sample height
d_i	Sample height for i -th sample
γ	Teeth walls inclination angle
c	Cohesion
ρ	Internal friction angle
S_c	Uniaxial compressive strength
S_r	Uniaxial tensile strength
E	Young modulus
p_k	Prandtl solution
H	Height of the crusher’s working chamber
h_i	Height from point of applied force to crusher’s working chamber beginning
A	Width of the crusher’s inlet slot
B	Length of the crusher’s inlet slot
s	Moving jaw displacement
n_c	Nominal angular velocity of the drive shaft
D	Feed size
m	Mass
t_c	Crushing time
i	Number of samples
k	Number of subsequent cycles of operation

***Corresponding author: Sebastian Bąk**, Warsaw University Of Technology, Faculty Of Automotive And Construction Machinery Engineering, E-mail: sebastian.bak@pw.edu.pl

Paweł Ciężkowski, Jan Maciejewski, Arkadiusz Kwaśniewski, Warsaw University Of Technology, Faculty Of Automotive And Construction Machinery Engineering

1 Introduction

The improvement in mineral crushing process efficiency is a very important issue, especially from a technological point of view, which takes into account the preparation of a product with an appropriate grain size and shape (aggregate production). Economic aspects related to energy consumption and cost-consuming processes are equally important. The selection of appropriate crushing devices at each stage of crushing and their configuration have a fundamental influence on the quality of the products as well as the efficiency and energy consumption of the technological systems of minerals processing. The technological process should also be matched to the material properties to ensure maximum effects in terms of technology, economy and ecology.

The jaw crusher works on the initial stage of the crushing process (the first stage of crushing) in the raw material processing plant. In mining these crushers are used for processing ores, coal and rock materials. The most common crushers used are double toggle (such as Blake type) or single toggle jaw crusher (Dalton type). In this work, studies on Blake type jaw crusher were carried out. This machine was developed in the year 1857 (Patil and Desale^[1]) and was designed for crushing of medium and high hardness materials (Palmström^[2]). In the crushers, fast-wearing parts are the crushing plates; this is mainly due to the way the crusher works Bajorek et al.,^[3] Donovan,^[4] Jinxi et al.,^[5] Nowak and Gawenda,^[6] Napier-Munn et al.,^[7] Oduori et al.,^[8] Zawada and Pawlak,^[9] Zeng and Forsberg,^[10] properties of the crushed material and cracking process of the feed Theron and Aldrich,^[11] Tromans.^[12] This is the reason why it is fully justified to study the shape of the plates, because this allows to improve the crushing process parameters. This topic was researched by Zawada,^[13] Ciężkowski et al.,^[14-20] Kobiałka and Naziemiec,^[21] Lindqvist and Evertsson,^[22] Numbi et al.^[23]

Based on the obtained results, authors found out that the use of a toothed plate together with a flat plate may be advantageous for single-toggle jaw crushers. With a similar degree of fineness and the amount of irregular grains in the product, an increase in crusher's technical performance can be achieved.

Shapes of the crushing plates and crushing processes that takes place in the working chamber of jaw crusher are closely linked together. The working surface of the jaws can be flat, used for thick crushing of very hard rocks and for fine crushing, or the plate can be grooved (toothed) (Fig. 1). This type of plates is most commonly used today (Patil and Desale^[1]).

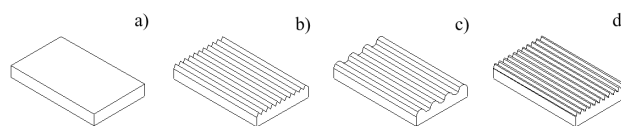

Figure 1: Profiles of crushing plates: a) flat, b) triangular, c) rounded, d) trapezoidal

In the existing industrial crushers, the shape of the plates does not change along with the change of the crushing chamber height (Fig. 1). This feature reduces the crushing efficiency, because the profile should be adapted to the size of the crushed feed. Difficulties in explaining the crushing processes have not, so far, provided the basis for analyzing the influence of crushing plates' profile on the crushing effects. This problem is underestimated by the designers and scientists. Greater importance is attributed to the shaping of the crushing chambers (longitudinal profile of Zawada and Pawlak^[9]). The few experiments so far show a wide variety of crushing effects depending on the shape of the crushing plates profiles (Kobiałka and Naziemiec,^[21] Zawada et al.,^[13] and Ciężkowski et al.^[14]).

In the present work, the new type of plates with variable pitch and width of the teeth are proposed. From the considerations presented in the work Zawada^[24] appears that both the optimal width of the stamps (i.e., the width of the trapezoidal profile) and the pitch t are a function of the size of the crushing rock block. In the work of Ciężkowski et al.^[14] a simplified way of determining the geometric parameters of the jaw plate profile was presented, treating the crushing process as a model crushing process by stamps of width a . Considerations began with an attempt to determine the size of rock blocks in the crusher's chamber. This was used to determine the model of loading the elementary rock.

Figure 2 shows the basic dimensions of the crushing plate teeth of the crushing plate.

2 Crushing and failure mechanisms

This section presents a simplified method of determining the width of crushing plate stamp a . The considerations began with an attempt to determine the size of rock blocks d_i in the crusher chamber (Fig. 3a). This was used to determine the load model of the elementary rock blocks. The analysis was carried out for a laboratory double-toggle jaw crusher.

Figure 3a shows the compression of a sample feed in the jaw crusher and two dead center positions of the moving jaw AA and A_rA_r . The grain size depends on the

height of the working chamber whose characteristic dimensions are: height H (effective crushing occurs for $H_i < H$), outlet slot e_r , and moving jaw displacement s . The process presented in Fig. 3a is simplified in Fig. 3b. In the considered model of the crushing process, an analogy between material crushing in the crusher and crushing the cuboid block between the two coaxial stamps is used (Fig. 3b). The problem of ductile block cutting was presented by Hill,^[25] Sokołowski,^[26] Rychlewski,^[27] Szczepiński,^[28–29] Izicki and Mróz,^[30] Zawada,^[24–31] Chen and Drucker^[32] and other authors.

The problem of rock block crushing by two coaxial stamps can be solved in a strict manner by the method of characteristics or the limit state method (Izicki and Mróz^[30]). Figure 4 shows the solution examples.

In order to determine the width of the stamps causing rock block to split into two pieces, a model process of compressing the material by flat coaxially arranged

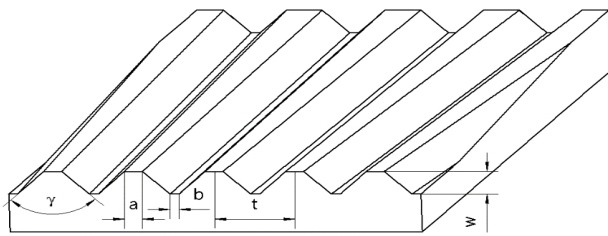

Figure 2: Crushing plate profile dimensions: t - pitch, distance between teeth, w - teeth height, a - crushing surface width, γ - teeth walls inclination angle, b - width of the bottom of teeth

stamps was analyzed. Fig. 4a shows the Prandtl failure mechanism, which was assumed to calculate the limit state for the given block. The method of characteristics (Fig. 4b) was used to solve this problem, assuming rigid, perfectly plastic behavior of the material and the model described by the linear Coulomb condition. For these assumptions, Prandtl solution is given by:

$$\frac{p_k}{c} = ctg\rho \cdot \left[tg^2 \left(\frac{\pi}{4} + \frac{\rho}{2} \right) \cdot exp(\pi tg\rho) - 1 \right] \quad (1)$$

where: c – cohesion, ρ – internal friction angle.

Assuming the modified Coulomb condition, the limit load for global failure mechanism is described for upper bound by:

$$\frac{p_{kg}}{c} = \frac{S_c + \frac{d_i}{a} \cdot S_r \cdot tg \left(\frac{\pi}{4} + \frac{\rho}{2} \right) - S_r \cdot tg^2 \left(\frac{\pi}{4} + \frac{\rho}{2} \right)}{c} \quad (2)$$

where: S_c – uniaxial compressive strength, S_r – uniaxial tensile strength, d_i – sample height.

The graph in Fig. 5 shows the solution obtained by the method of characteristics, where the limit pressure p/c is given as a function of d/a . The AB line corresponds to the global mechanisms and the horizontal line is Prandtl solution (1), independent of the block size. The point Bwl of the intersection of both lines corresponds to the width of the stamp for which rock block splits in two.

Based on the $p/c = f(d/a)$ graphs, the minimal stamp width a was determined for particular height of the crushed block (see Fig. 3). Fig. 6 shows the relationship between stamp width a and feed dimension d for different internal friction angles ρ . It is visible that in the case of

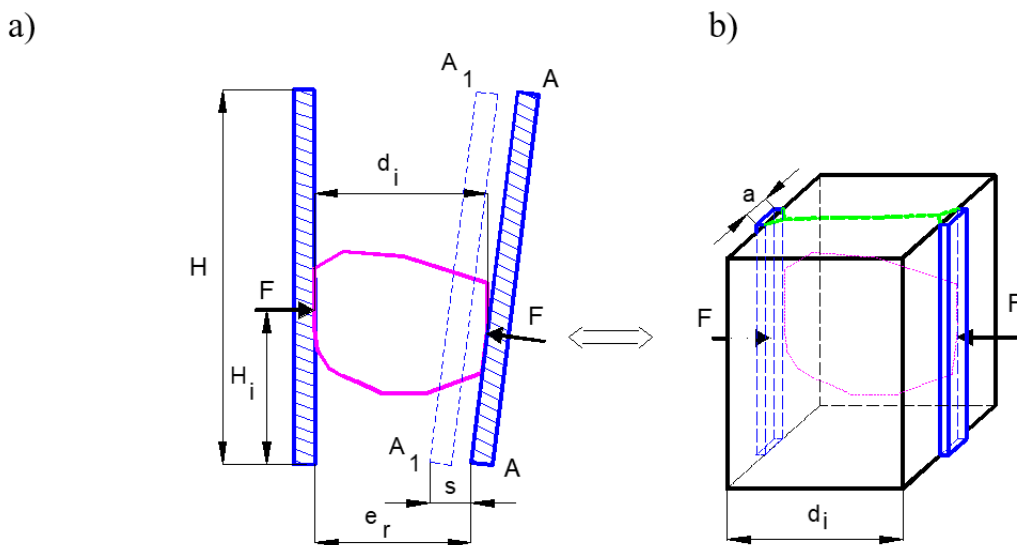

Figure 3: The crushing process in the space of the jaw crusher a) compression in jaw crusher, b) elementary case of the crushing modeling – compressing the rock block between flat stamps

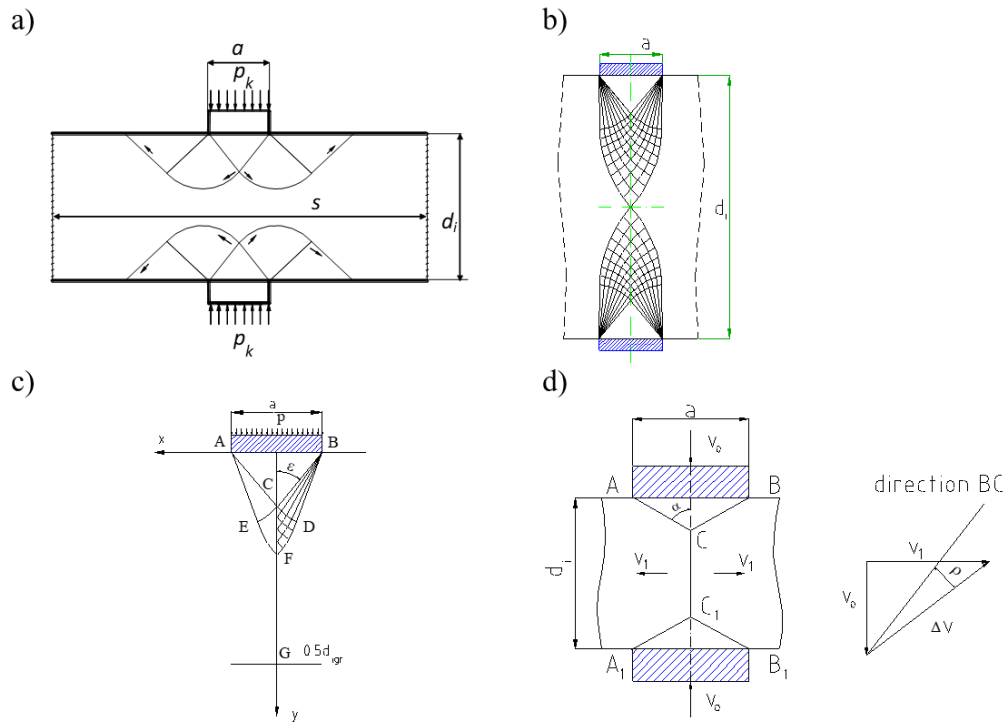

Figure 4: Local and global failure mechanism: a) Prandtl failure mechanism (Prandtl^[33]), b) global failure mechanism (method of characteristics) for $d_i/a = 12.22$ and $\rho = 15^\circ$, c) solution for the modified Coulomb condition, the method of characteristics grid for $\rho = 10^\circ$, $S_c/S_r = 5$, d) determination of the upper limit: block compressed by flat stamps (modified condition)

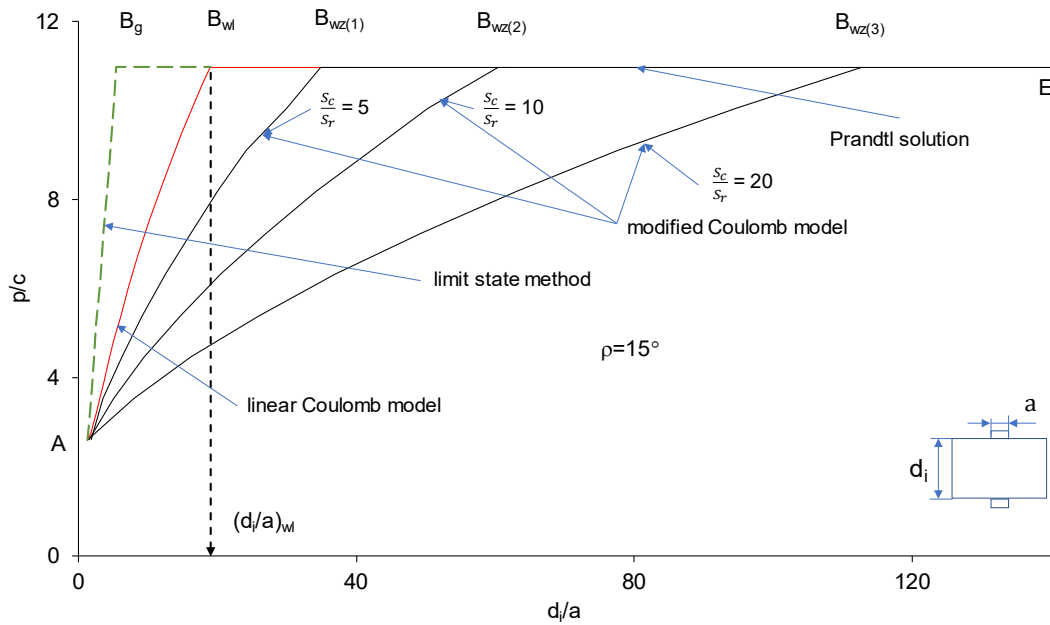

Figure 5: Limit load p/c as a function of d/a

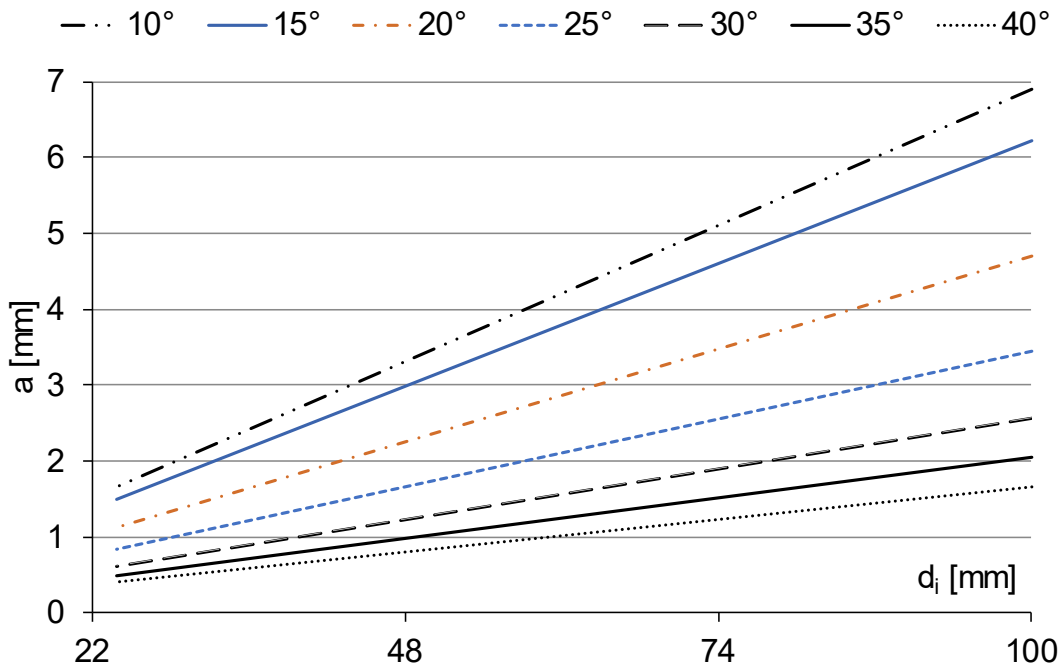

Figure 6: Determining the optimal dimensions of a stamp width for different internal friction angles ρ using the method of characteristics and the linear Coulomb condition for the laboratory crusher

hard materials, crushing stamp shape should be close to sharp or slightly rounded.

This work analyzes an optimum width of the stamp, which depends on the height of the crushed block of the feed. Using the developed numerical algorithms, the $p/c = f(d/a)$ charts were compared for the limit state basic conditions, that is, the linear and modified Coulomb condition. This solution can also be obtained by (2) using the limit state method. In the case of the method of characteristics and the modified condition, the values of d_i/a ratios depend on the S_r/S_f ratio, which corresponds to the position of points $B_{wz(1)}, \dots, B_{wz(4)}$ points.

Let us consider now, after determining the optimal width of stamps a_{opt} , the method of determining the optimal pitch t_{opt} . In the case of crushing by coaxially arranged group of stamps (Fig. 7), it can be seen that the load and boundary forces change depending on the pitch. For the given material strength parameters and geometrical parameters of the rock block and the width of the stamps, t_{opt} can be determined, for which the deformation mechanism will cause the material to be divided into as many blocks as possible. Based on the considerations in Ciężkowski,^[14] it can be seen that for the larger pitches' t_{opt} , rock block breaks into three large rigid blocks with the material remaining between the stamps, which practically act as a pair of independent teeth (Fig. 8b). For smaller pitches, the stamps act as one wide tool,

causing the rock block to cut in half (Fig. 8a). This pitch t_{opt} is therefore the optimal spacing of teeth that should be used in crushing of rock blocks if we want to achieve high efficiency of crushing.

The most important operational and technical parameters of jaw crushers are the size of the working chamber, displacement of the moving jaw (throw s), bracket angle a (the angle between the surfaces of the fixed and moving jaw at the dead center when the moving jaw is as close to the fixed jaw), the angular velocity of the drive shaft (no-load running) n , the size of the outlet slot e_r (the distance between the plates at the narrowest point of the working chamber), longitudinal and cross section profile of plates (Kobiałka and Naziemiec,^[21] Zawada and Pawlak^[9]). In the industrial environment, outlet slot e_r and throw s can be adjusted. The other parameters are selected at the design stage for a given technological line Gawenda,^[34] Rajan and Singh.^[35]

This paper is a continuation of the work performed at the Institute of Construction Machinery Engineering in the area of crushing plates' shape optimization by Ciężkowski.^[14,19,20] Experimental research results show that the use of plates with variable pitch and teeth height proved to be a beneficial modification of the crushing plates' surface for which the crushing energy and forces reach low values.

This type of research is essential for increasing the performance of crushing process, reducing energy

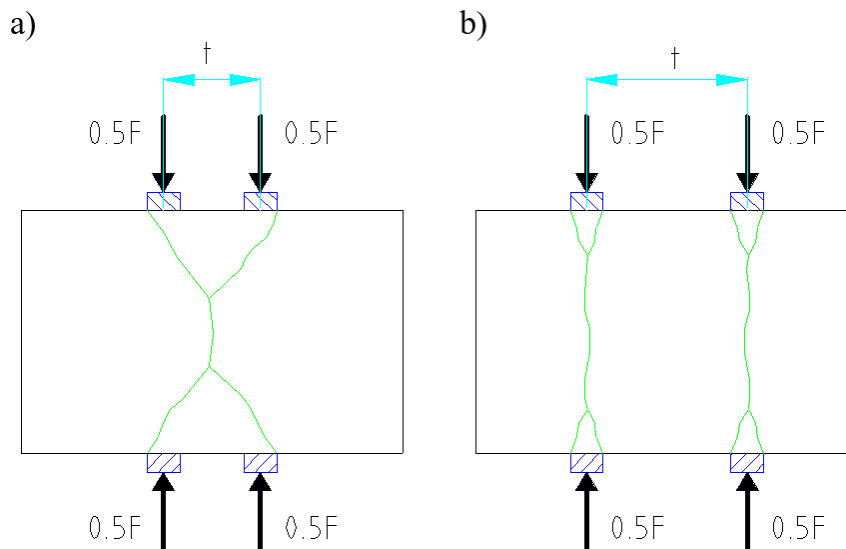

Figure 7: Failure mechanism for coaxially arranged stamps for various pitch length

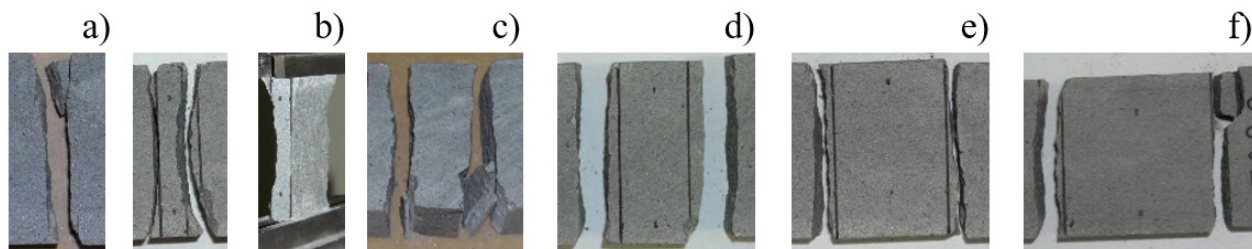

Figure 8: Crushing of “Mucharz” sandstone by a group of four flat coaxially arranged stamps. Sample failure mechanisms for different t/h ratios: a) 0.08; b) 0.23; c) 0.38; d) 0.45; e) 0.72; f) 0.94

consumption and achieving aggregates with appropriate parameters (attributes) – Ciężkowski,^[14] Ciężkowski et al.,^[15] Ciężkowski,^[16] Ciężkowski and Maciejewski,^[18] Gawenda,^[34] Frankiewicz,^[36] and Grzelak.^[37]

3 Experimental studies

3.1 Materials and methodology

The analysis was carried out for a laboratory double-toggle jaw crusher designed and manufactured at the Institute of Construction Machinery Engineering. The technical parameters that describe the machine are as follows: height of the crusher’s working chamber – $H = 249$ mm, the dimension of the inlet slot – $B \times A = 200$ mm \times 100 mm, dimension of the outlet slot – $B \times e_r = 200$ mm \times 24 mm, moving jaw displacement – $s = 6$ mm, and nominal angular velocity of the drive shaft – $n_c = 388$ rpm. Machine

is equipped with measurement system for recording crushing forces values in toggle plate and moving jaw displacement at the same time.^[6]

The material used in the tests was sandstone from Polish mine “Mucharz” with the following strength parameters: uniaxial compressive strength – $S_c = 122.8$ MPa, uniaxial tensile strength – $S_t = 11$ MPa, internal friction angle – $\rho = 34^\circ$, cohesion – $c = 31.8$ MPa, Young’s modulus – $E = 16.9$ GPa.

The uniaxial compressive strength was determined by a uniaxial compression test of samples with a diameter of $\varnothing 22.6$ mm and a height of 53 mm. Tensile strength was determined on the basis of the transverse compression test (Brazilian test), carried out on samples with a diameter of $\varnothing 22.6$ mm and a length of 22.6 mm. Other parameters, that is, the internal friction angle and cohesion, were determined by triaxial tests.

Tests carried out in this work were performed on the feed subjected to the geometric selection. Samples consisting of irregular lumps having a similar average

particle size were prepared. Sample specimen is shown in Figure 9.

In order to verify the crushing process parameters, experimental tests were carried out according to the scheme shown in Figure 10. Sandstone grains with size of 80-100 mm and total mass around 7.5 kg was fed into the crusher. For each set of crushing plates, 10 series of tests were conducted. Study was performed for open circuit crushing, which consists of a single flow of feed processed through a series of devices working with the selected speed. Open circuit crushing is designed to avoid the formation of excessive amounts of fine particles and dust and to minimize energy consumption, especially at high degrees of fineness applied in one crusher (Grzelak,^[37] Kurdowski^[38]).

Crushing forces were measured by means of strain gauges placed on the front toggle plate (Zawada et al.,^[13] Ciężkowski,^[14] Ciężkowski^[17]) and a computer system with a software recording the values of crushing forces over time. The crushing chamber cross-section including crushing plates with variable teeth width and pitch and the arrangement of transducers is shown in Fig. 10. These transducers are marked with the following numbers: I – toggle plate (3a) with appropriately applied strain gauges for force measurement in toggle plate, II – strain gauge transducer for moving jaw displacement measurement

The aim of this work is to present the influence of the new plates' shape (set VI, Fig. 12) on the crushing process parameters, namely: technical performance, product particle size distribution, maximum and average crushing forces, and crushing energy.

In the study, the following sets of crushing plates were used: flat plates (Fig. 12a), plates with triangular profile with an apex angle 90° and pitch $t = 20$ mm (Fig. 12c). For plates with variable pitch and height of the teeth (plates also have an apex angle 90°), the pitch of the upper part was $t = 20$ mm and the bottom – $t = 14.6$ mm, the bottom part of the plate is flat – 20% of the working surface (Fig. 12d, e). In the sixth series of the study, the crushing process was carried out between trapezoidal plates with variable geometry. In the upper part of the plate, pitch is $t = 30$ mm, tooth width is $a = 12.4$ mm, while in the lower part, $t = 11.4$ mm, $a = 4.8$ mm (Fig. 12f).

Calculation of the actual crushing process parameters is extremely important when it comes to the total cost of production. Otherwise, determining the load that depends on the shape of the working chamber and the crushing plates is needed in order to select the appropriate set of crushing plates to process the material. During the crushing process, forces are subjected to cyclic changes



Figure 9: An example of the specimen prepared for laboratory tests

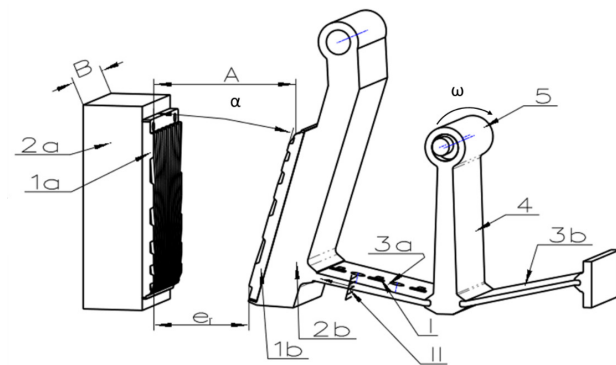

Figure 10: Scheme of the model jaw crusher: 1a, 1b – crushing plates, 2a – fixed jaw, 2b – moving jaw, 3a, 3b front end rear toggle, 4 – pitman, 5 – eccentric shaft, a, b – width and length of the inlet slot, I – force measurement system, II – moving jaw displacement measurement system

and their value varies stochastically according to the arrangement of the material in the crusher's chamber. In order to compare the effects of crushing by the given plates, a group of indicators was introduced. These indicators pertain to forces, energy and performance. They are:

- F_{peak} – maximum crushing force defined as the highest value recorded in one crushing cycle. In Fig. 13a, that value is indicated by F_{peak} ,
- $\bar{F}_{av_{max}}$ – average value of the maximum forces,

$$\bar{F}_{av_{max}} = \frac{1}{k} \cdot \sum_{i=1}^k F_{max_i} \quad (3)$$

where: F_{max_i} are values in subsequent cycles of operation, k – number of subsequent cycles of operation. This definition means the average of the maximum values recorded for each portion of feed.

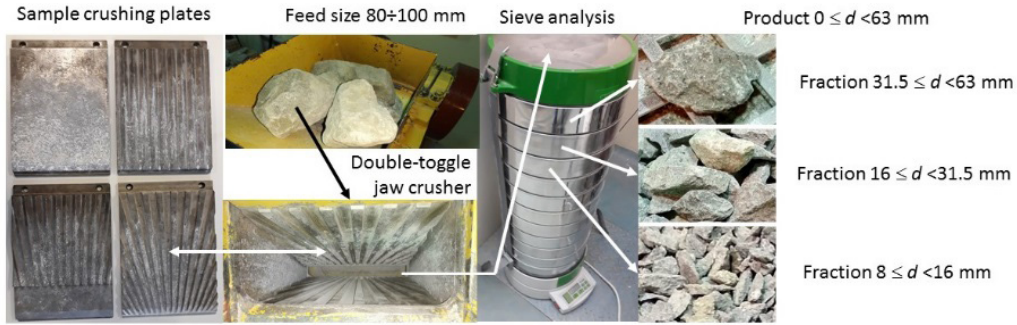

Figure 11: Diagram of crushing process – feed size, crusher’s working chamber, sample crushing plates, sample product fractions (fraction 8-16, 16-31.5, 31.5-63 mm)

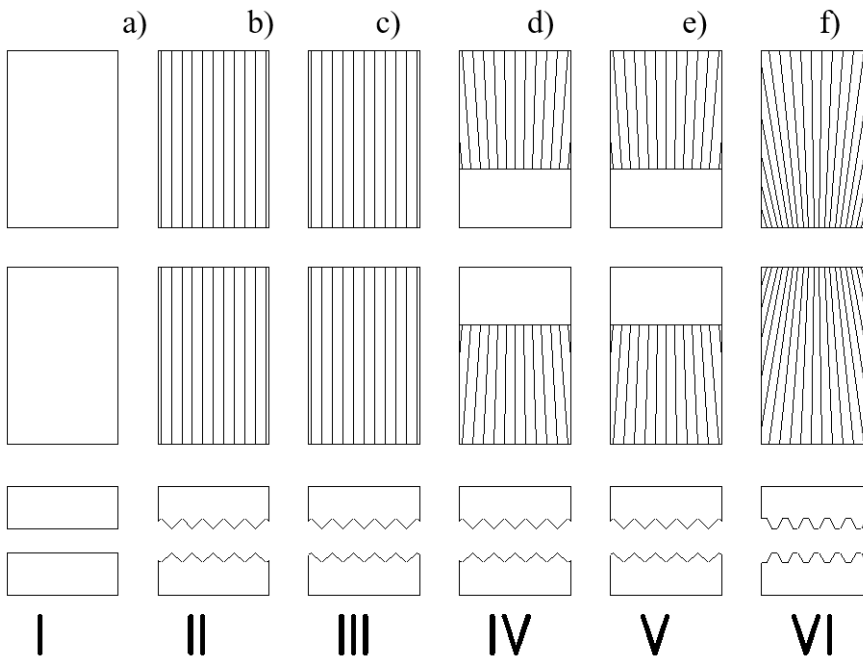

Figure 12: Plates used in the laboratory tests: a) flat, b, c) triangular profile, d, e) variable pitch and height of the teeth, f) variable width and pitch of the teeth (Fig. 6)

– \bar{F}_{av} – average value of the forces given by:

$$\bar{F}_{av} = \frac{\int_0^{t_c} F dt_c}{t_c} \quad (4)$$

$$L_e = \sum_{i=1}^k L_{ec}, \quad i = 1, \dots, k \quad (6)$$

– L_s – specific energy is the ratio of the effective energy L_e recorded in a given specimen to its mass m :

$$L_s = \frac{L_e}{m} \quad (7)$$

– L_{ec} – effective energy in one cycle is determined as:

$$L_{ec} = \oint F ds = \sum_{j=1}^n \left(\frac{1}{2} \cdot (F_j + F_{j-1}) \cdot (s_j - s_{j-1}) \right), \quad j = 1, \dots, n \quad (5)$$

where F_j, s_j – forces and displacements measured in n points on the line A–C in Fig. 14.

– L_e – effective crushing energy is equal to the sum of energy obtained in the subsequent crushing cycles:

– W_t – technical performance – feed mass to crushing time ratio:

$$W_t = m/t_c \quad (8)$$

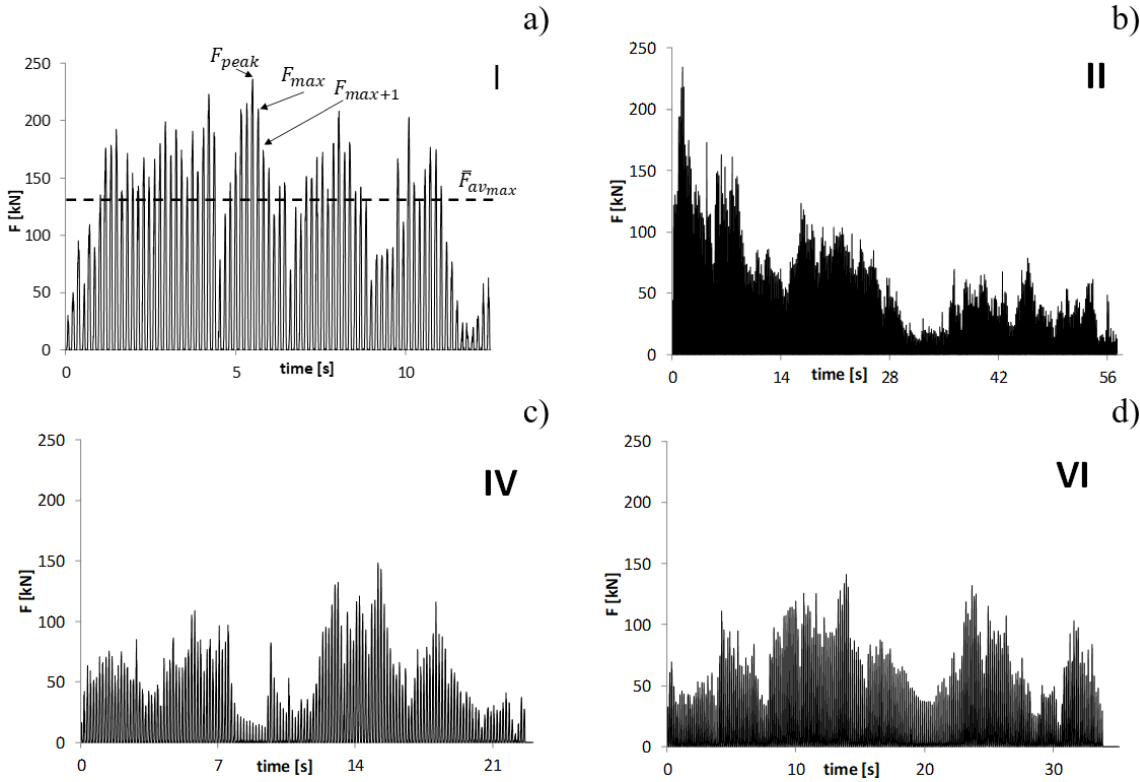

Figure 13: Diagrams of force F in toggle plate as a function of time for the entire attempt: a) flat plates-set I, b) triangular profile plates and coaxial arrangement of teeth – set II, c) variable pitch, height and coaxial arrangement of teeth – set IV, d) variable width, pitch and coaxial set of teeth – set VI

Figure 13 shows four exemplary graphs of force changes over the time for crushing between flat plates (set I - Fig. 13a), plates with triangular profile and coaxial set of teeth (set II - Fig. 13b), plates with variable pitch, height and coaxial set of teeth (set IV - Fig. 13c) and between new plates with coaxial arrangement of teeth (set VI - Fig. 13d). Data were recorded every 2 milliseconds. It has been observed that depending on the type of crushing plates being tested, there is a different duration of the crushing process, which is related to the crushing efficiency.

Figure 14 shows the two exemplary consecutive cycles of the sandstone crushing by flat plates (Fig. 14b - enlarged diagram in the time period from 5.42 to 5.72 s). With the approach of the moving jaw to the fixed one, thrust of the jaws increases, but it increases unevenly, sometimes experiencing a little decrease associated with the local rock crushing process. The highest values of toggle plate thrust exist near the point of minimum opening between the jaws (points B_1 and B_2 in Figure 14a, b). At the points C_1 and C_2 , return movement of the jaw starts as the rapid reduction in the thrust force. In this study, the moving jaw displacement reaches 5.4 mm (points D_1 and D_2). The variable value of the moving jaw displacement is associated with the flexibility of the crusher.

3.2 Influence of feed mass on crushing process parameters

In the first stage of the experimental research, influence of the amount of feed used (its mass) on crushing process parameters, that is, force, crushing energy, performance and crushing time. The crushing process was carried out between the flat plates (set I).

Based on the obtained results (Table 1), it can be noticed that from a sample weight of approx. 6 kg, similar values for specific energy, maximum crushing force and technical performance are obtained.

3.3 Influence of crushing plates' shape on the crushing process parameters

In the second stage of the studies presented in this paper, the influence of different plate shape and teeth arrangement on crushing process parameters was compared. Figure 13 presents the principle of measuring of the outlet slot adopted in the experiment. In the experiment, the outlet slot equal to $e_r = 24$ mm was adopted.

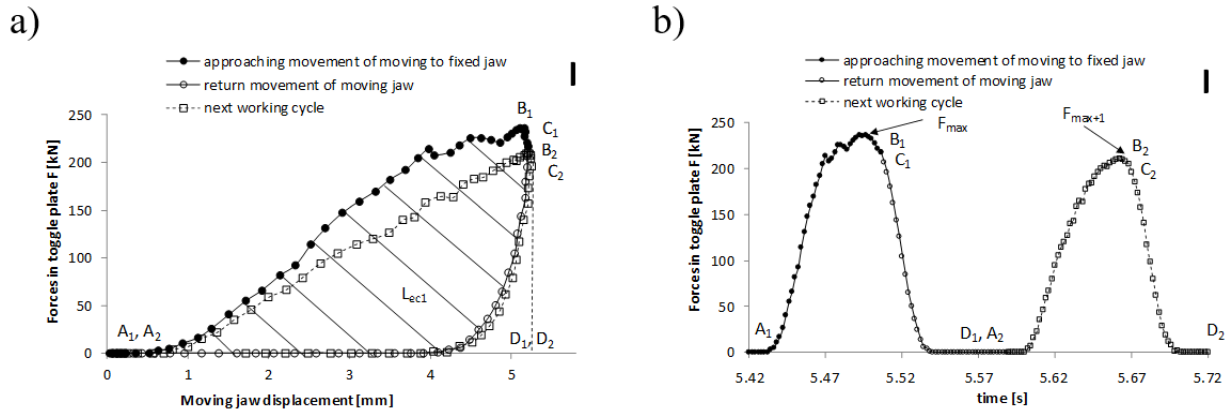

Figure 14: The two exemplary operation cycles of sandstone crushing by flat plates a) force vs. displacement diagram b) force vs. time diagram

Table 1: Changes in crushing parameter values as a function of feed mass. Maximum crushing force, specific energy, technical performance and crushing time. Crushing of sandstone “Mucharz” between the flat plates

Feed size	Mass	Specific energy	Maximum crushing force	Technical performance	Crushing time	Number of samples
D	m	L_s	F_{peak}	W_t	t_c	i
[mm]	[kg]	[kJ/kg]	[kN]	[t/h]	[s]	[-]
90	2.01	2.71	202.14	1.71	4.23	12
90	3.44	2.83	221.81	1.79	6.93	11
90	3.92	2.9	231.93	1.84	7.69	11
90	4.78	3.02	261.98	1.93	8.9	12
90	6.2	3.1	269.94	2.07	10.8	11
90	7.37	3.07	262.80	2.13	12.44	12
90	10.2	3.12	265.43	2.14	17.13	11
90	20.5	3.11	267.32	2.12	34.81	11

To perform sieve analysis, a set of reference sieves was used. Set consisting of 10 screens of square mesh size $\varnothing = 0.063, 0.125, 0.25, 0.5, 1, 2, 4, 8, 16, 31.5$ mm was placed on a laboratory shaker $\varnothing 300$ mm LPzE-3e. Crushing product of each test was put onto the top sieve and subjected to screening for 2 min.

Based on the obtained results (Table 2), it can be noticed that regardless of the shape of the plate used, the grains in the range from $4 \leq d < 31.5$ mm dominate. In the case of flat plates (set I), 81% of these grains were obtained, and for set VI, 84% of these grains were obtained in the product.

Table 3 presents the comparison for six sets of plates related to the average grain size of the product $d_{80\%}$ and the degree of fineness $n = D/d_{80\%}$.

The comparison of product particle size distribution shows that for a set with flat plate, a finer product (higher degree of fineness) was obtained than for the profiled plates. The degree of fineness $n_{80\%}$ for flat plates was higher by 11% in relation to set VI. For the other profiled plates, the results of the analyzed parameters were similar to the VIth set.

Maximum crushing forces F_{peak} , average maximum forces $\bar{F}_{av,max}$, specific energy and technical performance for a laboratory jaw crusher and six sets of crushing plates are presented in Table 4. On the basis of the obtained results, it can be noticed that the crushing process between the new plates takes place at the lowest value of forces and specific energy.

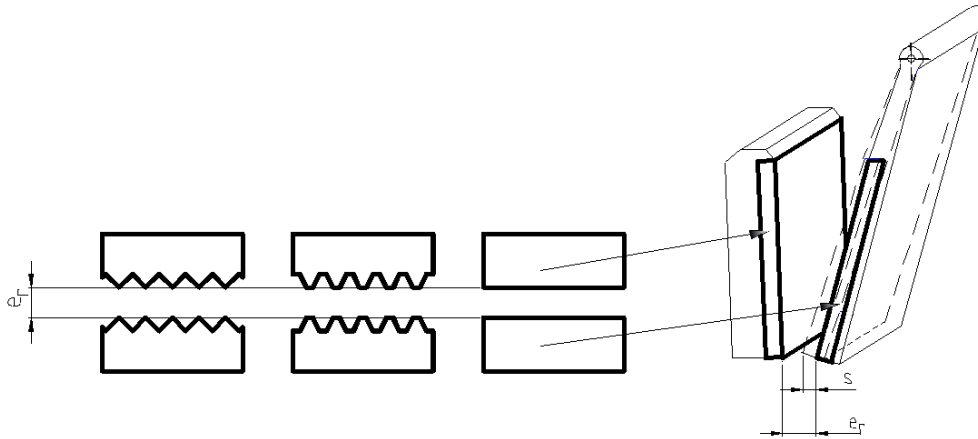

Figure 15: Scheme of measurement of the outlet slot e_p for different plate sets, s - moving jaw displacement (throw)

Table 2: Product particle size distribution for 6 sets of crushing plates

Set	I	II	III	IV	V	VI
Fraction d [mm]	Residue on sieves, share of grain fraction f_n [%]					
$31.5 < d$	1.13	0.81	3.35	4.75	6.11	3.13
$16 < d \leq 31.5$	39.92	49.15	49.35	56.82	51.58	56.69
$8 < d \leq 16$	29.92	22.46	21.98	20.12	22.66	17.21
$4 < d \leq 8$	11.64	10.94	10.85	7.58	7.77	9.75
$2 < d \leq 4$	5.14	5.23	4.00	3.37	3.27	4.01
$1 < d \leq 2$	3.68	3.44	2.97	2.16	2.25	2.65
$0.5 < d \leq 1$	2.35	1.91	2.21	1.27	1.71	1.57
$0.25 < d \leq 0.5$	1.99	1.62	1.51	1.04	1.34	1.40
$0.125 < d \leq 0.25$	2.18	1.61	1.62	0.99	1.39	1.44
$0.063 < d \leq 0.125$	2.05	1.67	0.54	1.06	1.38	1.43
$d \leq 0.063$	0.66	1.17	1.62	0.84	0.54	0.73

Table 3: Product grain size, degree of fineness

Set	I	II	III	IV	V	VI
$d_{80\%}$	12.19	12.88	13.83	13.85	13.87	13.62
$n_{80\%}$	7.38	6.99	6.51	6.50	6.49	6.61

Presented results clearly show that using flat plates (set I) for crushing means highest crusher load. Crushing forces for these plates: F_{peak} and $\bar{F}_{av,max}$ reach highest values. Similarly, a high load is observed for the plates with a triangular profile and constant pitch t (parallel profiles, sets II and III). A significantly lower load occurs while using plates with oblique tooth setting (IV–VI). The process of crushing with oblique teeth is advantageous

because there has been a twofold decrease in the crushing forces' values compared to the crushing by flat plates (I) and by constant-pitch triangular plates (I, II). However, no influence on the crushing process parameters was noted in the case of coaxial and non-coaxial arrangement of the surfaces of crushing stamps.

A very important indicator of the crushing process efficiency is the specific energy L_s , which is the lowest for the sets of plates with oblique tooth setting (VI). The use of flat plates or constant pitch plates with a parallel teeth arrangement (set I, II, III) results in an energy consumption increase when compared to the VIth set: flat plates by 43%, and parallel plates by 73%. From the analysis of the crusher load and energy consumption, sets IV, V, VI should be considered the most advantageous.

Table 4: Crushing forces, crushing energy and technical performance

Crushing plates type	Maximum crushing force	Average maximum crushing force	Average crushing force	Specific energy	Technical performance
	F_{peak}	$\bar{F}_{av,max}$	F_{av}	L_s	W_t
	[kN]	[kN]	[kN]	[kJ/kg]	[t/h]
I	262.80	138.76	45.72	3.07	2.13
II	234.39	64.84	16.69	3.71	0.38
III	229.89	62.74	17.01	3.59	0.40
IV	148.25	59.64	18.12	2.29	1.10
V	152.18	60.52	18.23	2.31	1.24
VI	127.03	60.24	18.70	2.14	0.82

However, sets of plates with variable pitch (IV and V, VI) result in a lower process efficiency compared to the flat plates.

Technical performance W_t is one of the most important operational parameters of crushers; its increase through structural or kinematic changes (with the same dimensions of machines) is the topic of numerous works (Malewski^[39]). The use of plates with variable teeth geometry leads to an increase in the performance compared to the traditional plates with a parallel tooth system (sets II and III) – by 100% for VIth set and by 200% for sets IV and V. In the tests, the most effective crushing process was obtained for the sets with flat plates (sets I).

New plate shape is the most beneficial solution for sandstone crushing compared to the other sets due to the reduced crusher load and energy consumption. In the case of technical performance, it is necessary to modify the lower part of the plate and conduct further research to improve it.

4 Conclusions

By the method of characteristics and limit state method, a method for determining the optimal width of the plate teeth a as a function of the size of the crushed material was proposed. In jaw crushers, the distance between the jaws varies with the height and the optimal plate profile should be adapted to the chamber geometry and strength parameters of the crushed material. Based on the theoretical and experimental investigations of elementary crushing processes (Ciężkowski^[14]), a crushing plate with variable pitch t and teeth width a was developed and made.

Based on the results of the research, the following conclusions can be formulated:

- Plates with a variable profile contribute to lower crushing forces and energy consumption when compared with flat plates and triangular plates with parallel teeth.
- Grain composition analysis shows that using flat plates, the product achieves a more unfavorable silt fraction compared to the other sets of tested plates.
- Analyzing the results, it is seen that the degree of fineness reaches almost the same values for the analyzed plate sets and increases just for flat plates.
- Analyzing the teeth arrangement on the plate with coaxial teeth (set II and IV) and comparing them with the plates in which the teeth were offset (set III and V), no significant influence of the stamps' setting on the crushing process parameters was noticed.
- Analyzing the tests results, it can be noticed that the use of profiled plates leads to a significant reduction in technical performance.
- In the crushing plates design solutions used so far, the plate profile is constant. Conclusion from the obtained results is that the tooth width a and the pitch t should be adopted to the dimensions of the feed blocks in the crusher's working space and should therefore be variable.
- The optimal tooth width a is closely related to the crushed material strength characteristics.

Due to the obtained promising research results, research continuation is fully justified.

References

- [1] Patil R.R. and Desale P.S., Wear in stone crusher plate, International Journal of Advanced Research and Innovative Ideas in Education, 2015.
- [2] Palmström A., Measurement and Characterization of Rock Mass Jointing, Chapter 2 of the book: In-Situ Characterization of Rocks, 2001.
- [3] Bajorek G., Kiernia-Hnat M., Skrzypczak I., Prognozowanie badań typu kruszyw budowlanych w zależności od zamierzonego stosowania (*Forecasting of construction aggregate research in the intended proceedings*), Materiały Budowlane (*Building materials*), ISSN 0137-2971, nr 3, s. 80–82, 2013 (in Polish).
- [4] Donovan J.G., Fracture toughness based models for the prediction of power consumption, product size, and capacity of jaw crushers, Doctoral dissertation, Virginia Polytechnic Institute and State University, 2003, <https://vtechworks.lib.vt.edu/bitstream/handle/10919/28544/Dissertation.pdf?sequence=1>.
- [5] Jinxi C., Zhiyu Q., Guopeng W., Xingfu R. and Shichun Y., Investigation on kinematic features of multi-liners in coupler plane of single toggle jaw crusher, Industrial Electronics and Applications, p. 1639–1642, 2007.
- [6] Nowak A., Gawenda T., Analiza porównawcza kruszarek w wielostadialnych układach rozdrabniania skał bazaltowych (*The comparative analysis of crushers in basalt rocks comminution multiple stage systems*), Czasopismo Górnictwo i Geoinżynieria, (*Mining and Geoengineering*), ISSN 1732-6702, tom R. 30, z. 3/1, s. 267–278, 2006 (in Polish).
- [7] Napier-Munn T.J., Morrell S., Morrison R.D., Kojovic T., Mineral com-minution circuits – their operation and optimization. Julius Kruttschnitt Min-eral Research Centre, Monograph vol. 2, The University of Queensland, Brisbane, Australia, 1996.
- [8] Oduori M.F., Mutuli S.M., and Munyasi D.M., Analysis of the single toggle jaw crusher kinematics, Journal of Engineering, Design and Technology, vol. 13, no. 2, pp. 213–239, 2015.
- [9] Zawada J., Pawlak W.R., Einfluß der Oberflächenform von brechplatten für backenbrecher auf das Zerkleinerungsergebnis. Aufbereitungs-Technik, Nr 3, 1988.
- [10] Zeng Y., Forssberg E., Application of vibration signals to monitoring crushing parameters, Powder Technology, Vol. 76, pp. 247–252, 1993.
- [11] Theron D.A., Aldrich C., Acoustic estimation of the particle size distributions of sulphide ores in a laboratory ball mill. J. S. Afr. Inst. Min. Metall. 100, 243–248, 2000.
- [12] Tromans D., Mineral comminution: energy efficiency considerations, Miner Eng, 21, pp. 613–620, 2008.
- [13] Zawada J. (red.), Buczyński A., Chochół K., Rzeszot J., Wprowadzenie do mechaniki maszynowych procesów kruszenia (na przykładzie kruszarek szczękowych). (*An introduction to the mechanics of machine crushing processes for jaw crusher*). Wyd. Instytutu Technologii Eksploatacji w Radomiu, Warszawa 2005 (in Polish).
- [14] Ciężkowski P. (red.), Kruszenie skał - teoria, eksperyment i zastosowania inżynierskie. (*Rock Crushing – theory, experiments and engineering use*) Instytut Technologii Eksploatacji -PIB, Radom ul. K. Pułaskiego 6/10, Radom, 26-600: Instytut Maszyn Roboczych Ciężkich, 2016 (in Polish).
- [15] Ciężkowski P., Bąk S., Kuśmierczyk J., Load distribution of a fixed jaw for sandstone „Mucharz” crushing, AGH Journal of Mining and Geoengineering, ISSN 1732-6702, Vol. 37, no. 2, s. 15–23, 2013.
- [16] Ciężkowski P., Correlation of energy consumption and shape of crushing plates, Górnictwo i Geoinżynieria, 2012, 36, s. 91–100.
- [17] Ciężkowski P., Doświadczalne badania sił kruszenia szczękami o różnym kształcie, (*Experimental investigations of crushing forces generated by variable shape jaws*), Zeszyty Naukowe Instytutu Pojazdów, (*Proceedings of the Institute of Vehicles Warsaw University of Technology, ISSN 1642–247X*), 2012, 2/88, s. 21–34 (in Polish).
- [18] Ciężkowski P., Maciejewski J., Badania i analiza maszynowego procesu rozdrabniania wapienia zwartego Morawica, (*Experimental analysis of limestone crushing process*) Przegląd Mechaniczny, nr 5, s. 35–41, 2014 (in Polish).
- [19] Ciężkowski P., Maciejewski J., Bąk S., Evaluation of Influence of Crushing Plates Shape on „Mucharz” Sandstone Crushing Process, w: Proceedings of the 6th International Congress on Technical Diagnostic / Timofiejczuk Anna [i in.] (red.), 2018, ISBN 978-3-319-62041-1, ss. 239–252, DOI:10.1007/978-3-319-62042-8_22.
- [20] Ciężkowski P., Maciejewski J., Bąk S., Experimental studies on the efficiency of the crushing processes, LAP LAMBERT Academic Publishing, ISBN 978-613-9-84936-9, 2018, s. 1–84.
- [21] Kobiątka R., Naziemiec Z., Badania procesu kruszenia szczękami o różnym profilu poprzecznym, (*Researches over crushing process conducting by various transverse profile jaws*) Górnictwo i Geoinżynieria, (*Mining and Geoengineering*) numer 30, zeszyt 3/1, s. 125–136, 2006 (in Polish).
- [22] Lindqvist M., Evertsson C.M., Minerals Engineering, Volume 16, Issue 1, January 2003, Pages 1–12, doi.org/10.1016/S0892-6875(02)00179-6.
- [23] Numbi B.P., Zhang J., Xia X., Optimal energy management for a jaw crushing process in deep mines, Energy, Volume 68, 15 April 2014, Pages 337–348, <https://doi.org/10.1016/j.energy.2014.02.100>.
- [24] Zawada J., Obciążenia graniczne i pęknięcie skał, (*Limit loads and fracture of rocks in model processes of crushing*) Wyd. Nauk. PWN, Warszawa, 1995, (in Polish).
- [25] Hill R., The mathematical theory of plasticity. Oxford 1950
- [26] Sokółowski W.W., Teoria plastyczności (*Theory of plasticity*), PWN, Warszawa 1957 (in Polish).
- [27] Olszak W., Perzyna P. Sawczuk A., Praca zbiorowa pod redakcją, Teoria plastyczności (*Theory of plasticity*), PWN, Warszawa 1965, (in Polish).
- [28] Szczepiński W., Indentation of a plastic block by two opposite narrow punches. Bull. Acad. Polon. Sci., Ser. Sci. Techn. 14, 671–676, 1964.
- [29] Szczepiński W., Wstęp do analizy procesów obróbki plastycznej (*Introduction to the analysis of plastic forming processes*), PWN, Warszawa 1967, (in Polish).
- [30] Izbiński R.J., Mróz Z., Metody nośności granicznej w mechanice gruntów i skał (*Limits analysis methods for the bearing capacity in mechanics of soil and rock*), PWN, 1976 (in Polish).
- [31] Zawada J., Obciążenia graniczne skał w modelowych procesach (*Limit loads of rocks in model processes*), Wydawnictwo Politechniki Warszawskiej, Warszawa 1991 (in Polish).

- [32] Chen W.F., Drucker D.C., Bearing Capacity of concrete blocks or rock. J. Eng. Mech. Division, Proceed. ASCE, vol. 95, No EM4, 955-978, 1969
- [33] Prandtl L., Über die Härte Plastischer Körper. Nachr Ges, Wissensch, Göttingen, Math.-Phys. Klasse, 1920, 74–85.
- [34] Gawenda T., Rozdrabnianie surowców skalnych w kruszarce szczękowej typu L44.41. (*Crushing of raw materials rock in a jaw crusher type L44.41*) Surowce i Maszyny Budowlane (*Raw materials and construction machinery*), nr 2, pp. 37–42, Wydawnictwo BMP, 2010, Racibórz 10 (in Polish).
- [35] Rajan B. and Singh D., Investigation on effects of different crushing stages on morphology of coarse and fine aggregates, International Journal of Pavement Engineering, DOI: 10.1080/10298436.2018.1449, 2018.
- [36] Frankiewicz W., Zmiany określania jakości kruszyw drogowych na przykładzie normy PN-EN 13043:2004 (*Modifications of determination of aggregates' for roads quality based on the norm: PN-EN 13043:2004*), Prace Naukowe Instytutu Górnictwa Politechniki Wrocławskiej. Konferencje, ISSN 0324-9670, vol. 115, nr 46, s. 19–22, 2006 (in Polish).
- [37] Grzelak E., Technologia kruszyw mineralnych (*Technology of minerals aggregates*). Arkady, Warszawa 1973 (in Polish).
- [38] Kurdowski W., Poradnik technologa przemysłu cementowego. (*Guide for cement industry technologist*) Arkady, Warszawa, 1981 (in Polish).
- [39] Malewski J., Metody obliczania wydajności kruszarek, (*The method of prediction of crushers capacity*) Prace Naukowe Instytutu Górnictwa Politechniki Wrocławskiej. Konferencje, ISSN 0324-9670, vol. 97, nr 33, s. 135–146, 2002 (in Polish).