

A. TOFIL*, J. TOMCZAK*, Z. PATER*

CROSS WEDGE ROLLING WITH UPSETTING

WALCOWANIE POPRZECZNO-KLINOWE ZE SPĘCZANIEM

The paper describes cross wedge rolling with upsetting, a process in which axially symmetric parts with steps whose diameters are larger than billet diameters can be formed. Taking advantage of numerical modeling, the effect of such basic geometric parameters of the rolling process as the spreading angle, forming angle, reduction ratio, and rolling length on upsetting (defined by the diameter increase ratio) was determined. The paper also presents the results of experimental tests performed to roll a stepped shaft whose one step had a diameter half as large as that of the billet.

Keywords: cross wedge rolling, upsetting, FEM, experiment

W artykule scharakteryzowano proces walcowania poprzeczno-klinowego ze spęczaniem, w którym możliwe jest kształtowanie wyrobów osiowo-symetrycznych ze stopniami o średnicy większej od średnicy wsadu. Stosując modelowanie numeryczne określono wpływ podstawowych parametrów walcowania (kąta rozwarcia klina, kąta kształtującego, stopnia gniotu i długości walcowania) na efekt spęczania (charakteryzowany przez współczynnik wzrostu średnicy). Przedstawiono także wyniki prób doświadczalnych walcowania wałka stopniowanego, którego jeden ze stopni miał średnicę o 50% większą od średnicy zastosowanego materiału wsadowego.

1. Introduction

Cross wedge rolling (CWR) is a modern technology for forming metals and their alloys. Nowadays it is mainly used to produce stepped axes and shafts as well as to produce preforms which then undergo die forging in forging mills [1].

Despite its technological potential, the CWR process is not widely used in industrial conditions. The reason for this stems from the fact that it is difficult to design wedge tools, the use of which will not cause such disturbances of the forming process as core necking, uncontrolled slipping, or internal cracking [2, 3]. The occurrence of such disturbances results, among other things, from reducing the cross section of the rolled step. It is generally assumed that a billet diameter can be reduced by two times in one tool pass. To obtain a larger reduction, several tool passes are necessary (Fig. 1), which means however that the length of the tools is increased. Due to this fact, new CWR methods which would allow for intensifying the forming process are studied. In recent years, a number of new CWR methods have been developed, for instance, multi cross wedge rolling (MCWR), in which it is possible to use several wedge pairs simultaneously in the forming process [4, 5]. Another method worth focusing on is cross wedge rolling with upsetting, which has been described by Pater [6, 7]. The present paper will describe this method.

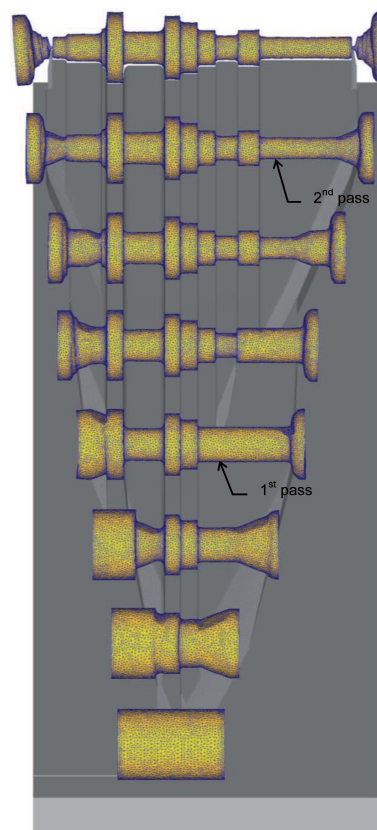

Fig. 1. FEM calculated shaft shape progression in CWR when two extreme steps are rolled in two passes of tools

2. Essence of cross wedge rolling with upsetting

In cross wedge rolling with upsetting (Fig. 2), the wedges affect the material from the frontal surface towards the middle part of the billet. Initially, a ring-shaped wedge groove is rolled, then – owing to the action of the side surfaces of the tools – the groove is transformed into a shaft step with the desirable diameter d . In the course of rolling, the step in the middle is subjected to the action of axial reducing forces, which leads to the upsetting of the step and its diameter increase to the value d_s .

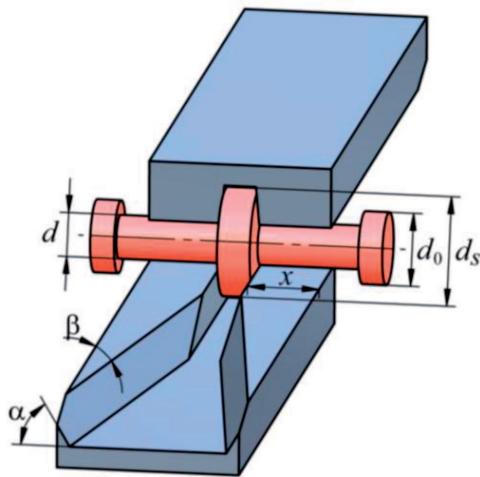

Fig. 2. Schematic diagram of CWR with upsetting, with important parameters marked

Apart from the enlargement of the middle area of the rolled part, it is also characteristic of cross wedge rolling with upsetting that the extreme steps get elongated. Naturally, the division of the material volume V_0 into the upset part V_1 and the reduced part V_2 (Fig. 3) depends on the applied rolling parameters. The following parameters are particularly important here: the forming angle α and the spreading angle β , the deformation ratio $\delta = d_0/d$, as well as the rolling length x (according to Fig. 2). According to the research results obtained by Klušin [8], neither the billet temperature nor the tool velocity has any significant effect on the upsetting of the material. The diameter increase of the upset step can be determined by means of the increase ratio ξ defined as:

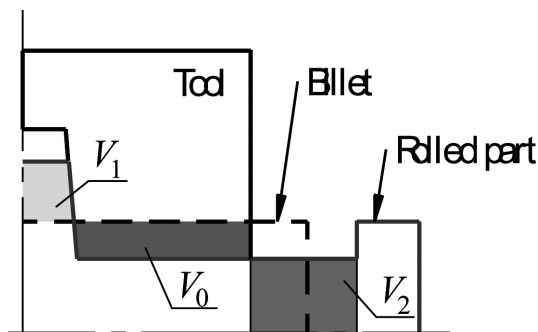

Fig. 3. Volume division in cross wedge rolling with upsetting

$$\xi = \frac{d_s}{d_0}, \tag{1}$$

where d_s is the diameter of the step which undergoes upsetting and d_0 is the billet diameter.

3. Numerical analysis

To determine the effect of the selected parameters (α, β, δ and x) of CWR with upsetting on the increase ratio ξ and the volume ratio V_1/V_0 , a number of numerical simulations were performed. Fig. 4 shows a geometric model of one of the analyzed processes of CWR with upsetting in which symmetry was used. The model consists of two identical wedge tools moving in the opposite directions and a cylindrical billet. The simulations were performed with the finite element method, using the DEFORM-3D programme, which has been used many times by various authors to analyze CWR processes [9, 10].

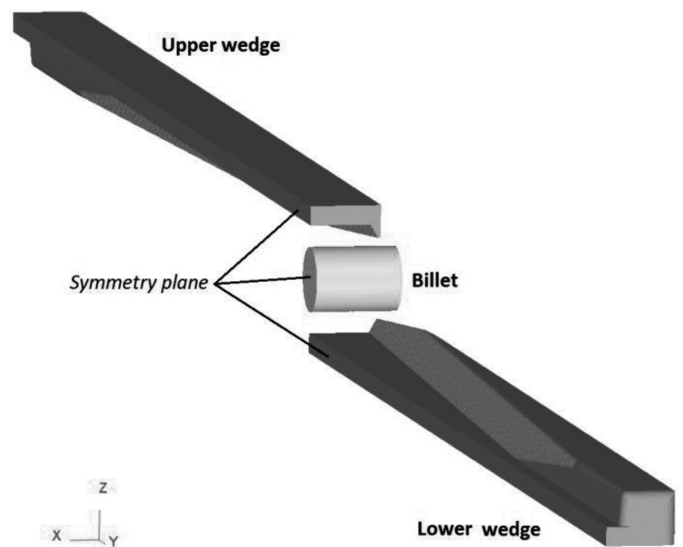

Fig. 4. Geometric model of analyzed CWR process with symmetry taken into account

The input data for the calculation included: material – C45 steel (the model was taken from the material database of the programme used), billet – a 30 mm diameter cylindrical rod heated to a temperature of 1100°C, tools – rigid elements with a constant temperature of 150°C, wedge velocity equal to 0.1 m/s, friction factor m set to 1, material-tool heat exchange coefficient equal to 10 kW/m²K. Additionally, the following variable parameters were included in the calculation: spreading angle β (from 2° to 5°), forming angle α (from 30° to 70°), reduction ratio δ (from 1.36 to 2.14), rolling length x (from 15 to 25 mm).

As a result of the performed simulations, the material flow kinematics in cross wedge rolling with upsetting could be investigated. Fig. 5 illustrates the changes in the velocity of axial material flow which occurred in one of the investigated cases. It can be observed that the material gets divided into two zones: the reduction zone and the upsetting zone. The most intensive material flow occurs in the part which undergoes upsetting, when the middle step diameter increases (interestingly, the material undergoes a complete deformation).

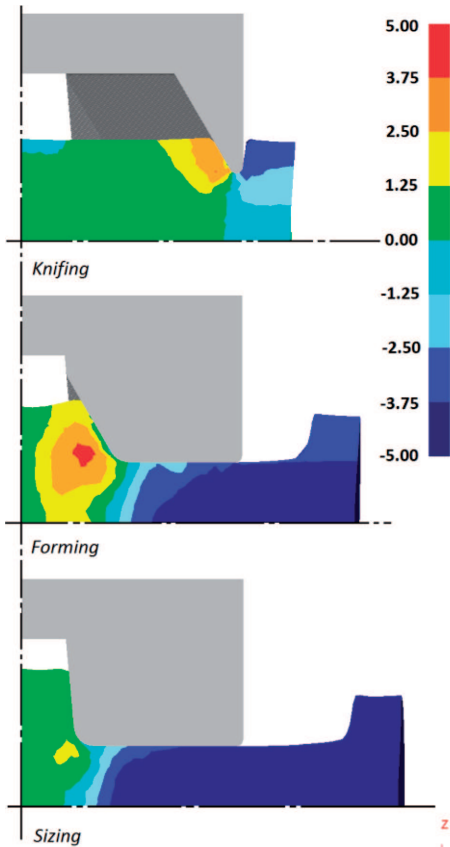

Fig. 5. Material flow velocity V_x (given in mm/s) in axial direction in longitudinal section of workpiece determined for CWR with upsetting at: $\alpha = 60^\circ$, $\beta = 3^\circ$, $\delta = 1.66$, $x = 25$ mm, $d_0 = 30$ mm

The effect of the basic forming parameters (α, β, δ and x) on the increase ratio ξ and the volume ratio V_1/V_0 was investigated, too. As a result, it was found that:

- ▶ decreasing the value of the spreading angle β from 5° to 2° leads to over a twofold increase in the values of both the increase ratio ξ and the volume ratio V_1/V_0 – Fig. 6,

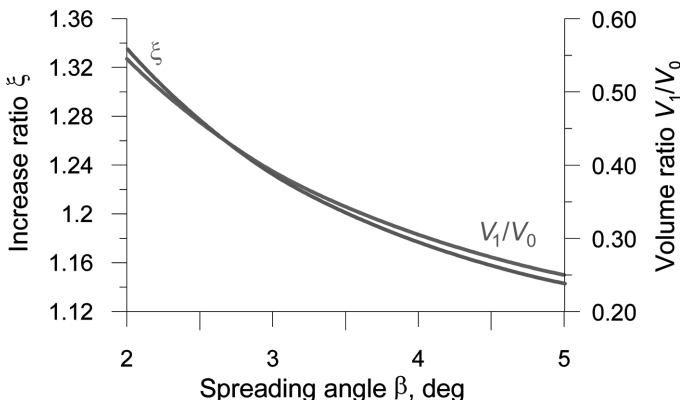

Fig. 6. Effect of spreading angle β on increase ratio ξ and volume ratio V_1/V_0 calculated at: $\delta = 1.67$, $\alpha = 30^\circ$, $x = 15$ mm

- ▶ the upsetting of the middle step, defined by the increase coefficient ξ and volume ratio V_1/V_0 , is the most effective if the value of the forming angle α equals 60° – Fig. 7,

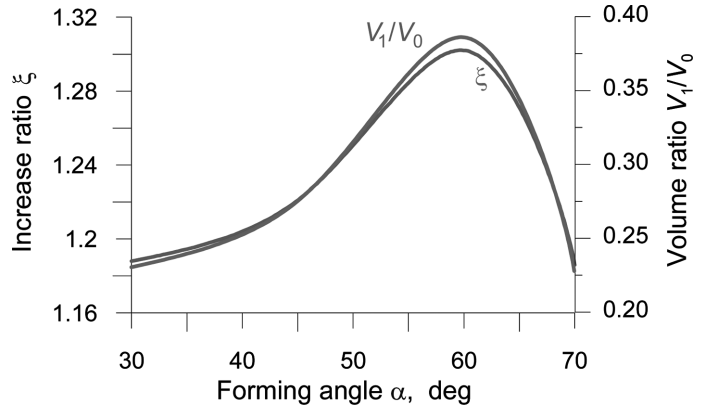

Fig. 7. Effect of forming angle α on increase ratio ξ and volume ratio V_1/V_0 calculated at: $\delta = 1.67$, $\beta = 3^\circ$, $x = 20$ mm

- ▶ the application of higher values of the reduction ratio δ leads to a directly proportional increase in the values of the increase ratio ξ and the volume ratio V_1/V_0 – Fig. 8,

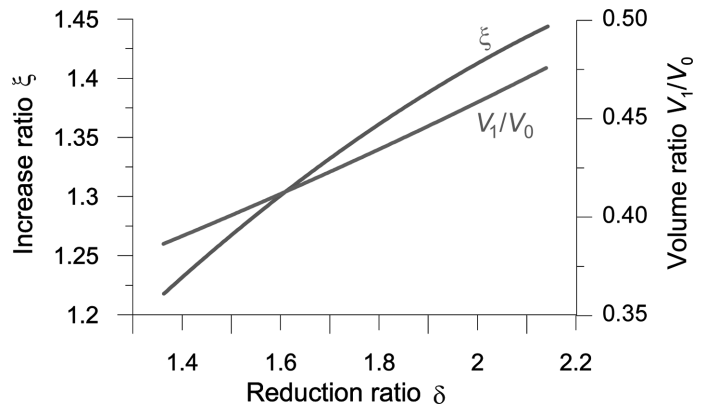

Fig. 8. Effect of reduction ratio δ on increase ratio ξ and volume ratio V_1/V_0 calculated at: $\alpha = 60^\circ$, $\beta = 3^\circ$, $x = 20$ mm

- ▶ the value of the increase ratio ξ increases together with an increase in the rolling length x , while the volume ratio V_1/V_0 does not depend on this parameter that much (an increase in the rolling length x first causes a slight decrease in the value of the volume ratio V_1/V_0 , but then the volume ratio increases) – Fig. 9,

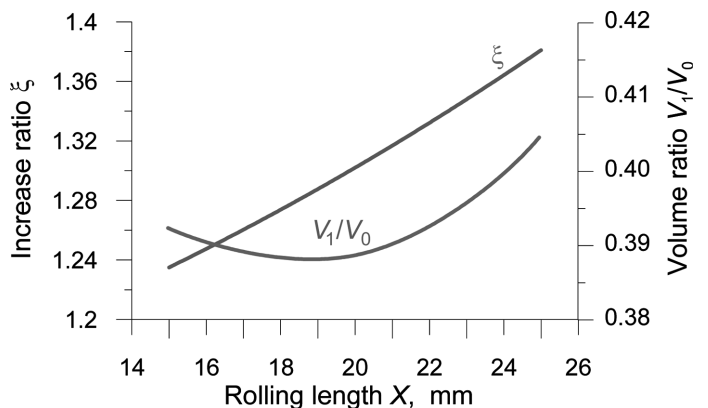

Fig. 9. Effect of rolling length x on increase ratio ξ and volume ratio V_1/V_0 calculated at: $\alpha = 60^\circ$, $\beta = 3^\circ$, $\delta = 1.67$

4. Example of the application of cross wedge rolling with upsetting

Taking into consideration the results of the conducted numerical simulations, a process for forming stepped shafts, based on CWR with upsetting, was developed. The process was carried out in laboratory conditions at Lublin University of Technology, which imposed some limitations as for the rolled part dimensions. It was assumed that in the process of CWR with upsetting a billet with the diameter d_o equal to 20 mm would be used to roll a shaft with one step diameter of 30 mm (Fig. 10).

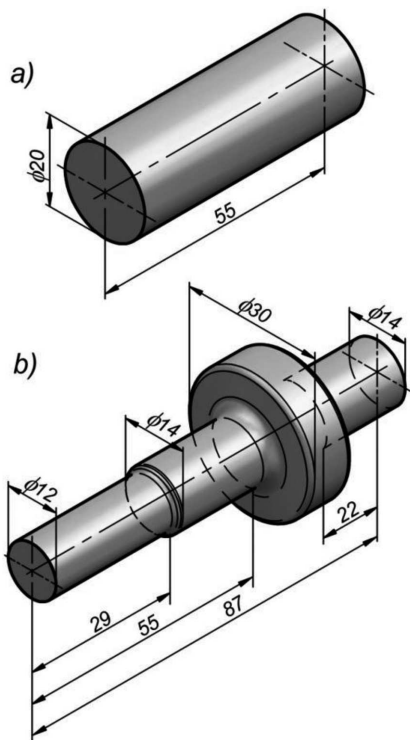

Fig. 10. Shape and dimensions of: a) billet, b) shaft

Fig. 11 shows the tools used in the rolling process, their angle values were: $\alpha = 60^\circ$ and $\beta = 2.5^\circ$. It was assumed that the extreme shaft steps (of 10 mm diameter) were to be rolled at the reduction ratio δ equal 2.0. On the wedge surfaces of the tools (in the forming zone), technological serrations were made to make the rolling process more stable (it increased the friction factor on the tool-material contact surface).

The experiments were performed using a flat-wedge laboratory mill, LUW-2, available at the Department of Computer Modeling and Metal Forming Technologies, Lublin University of Technology. In the experiments, the billet made of C45 steel was heated in a chamber furnace to a temperature of 1150°C. Next, the workpiece was delivered to the tool working space where the working surfaces of the wedge tools, moving in the opposite directions at the velocity v equal 0.125 m/s, formed a stepped shaft (Fig. 12).

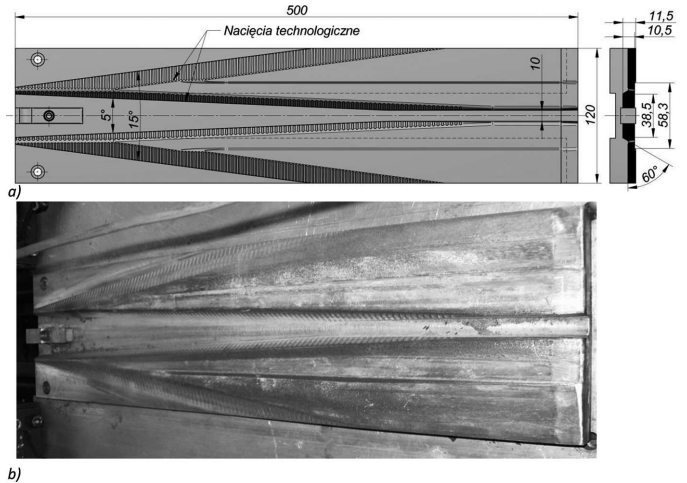

Fig. 11. Wedge tools used in CWR with upsetting of stepped shaft: a) 3D model with important dimensions marked, b) lower tool mounted on mill

The main purpose of the experiments was to verify the numerically obtained results for cross wedge rolling with upsetting. In the experiments, force parameters, process stability conditions, as well as geometric parameters of the rolled parts were investigated.

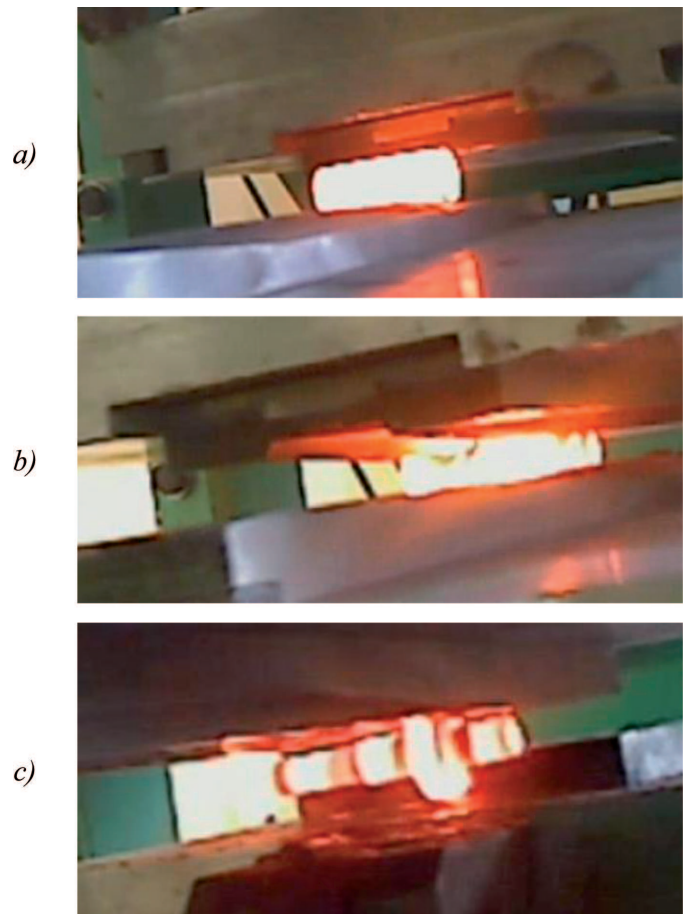

Fig. 12. Subsequent stages of CWR with upsetting for shaft with increased middle area: a) workpiece in tool rest, b) rolled part, c) finished shaft

On the basis of the performed experiments, it was found that it is possible to employ cross wedge rolling to form parts

with steps whose diameters are considerably larger than the diameter of the billet used. The obtained experimental tests results (concerning the shape and dimensions of the rolled parts) were consistent with the theoretical assumptions (concerning the shape of the rolled part assumed at the designing stage). The shape of the step obtained in the rolling experiments is shown in Fig. 13. The data given in the figure prove that the size of the diameter of the middle step increases considerably in the course of the rolling process, this increase amounting up to a half of the initial diameter of the billet, while the diameter of the extreme steps of the shaft gets significantly decreased (from 30% to 40%). Owing to a lack of symmetry of the rolled part, a small defect in the middle step occurs; the step profile in the axial plane resembles a truncated cone. It should be stressed that this shape defect lies within the tolerance range for hot-rolled parts. It is characteristic of CWR with upsetting that concave frontal surfaces occur, which results from the surface material flow. This means that cutters need to be used to remove the ends with the defects. The extent of the frontal surface defects can considerably be reduced if billets with conical ends are used.

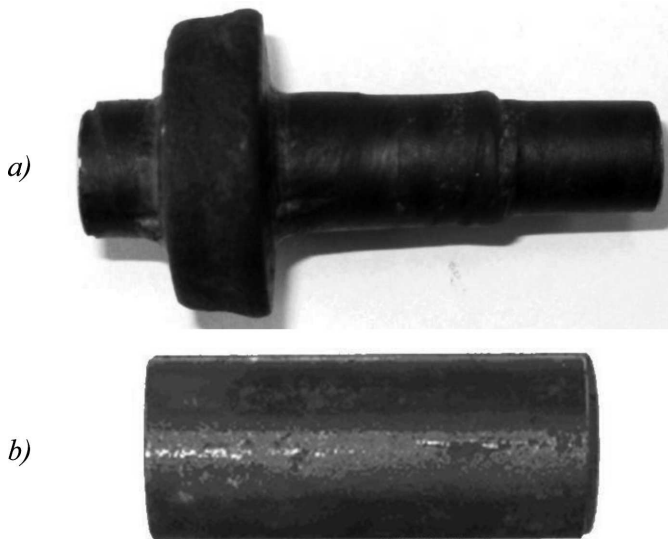

Fig. 13. Shape of part formed in CWR with upsetting (extreme allowances removed) – a, billet used in rolling – b

In the experiments, forming forces were also registered and investigated. Fig. 14 illustrates the distributions of the tangential force (which drives the wedge in) measured in CWR of shafts with upsetting of the middle step. The distribution of the forming force is different from what has been observed in the standard CWR processes, in which rolled parts are formed as a result of all shaft steps being reduced. Initially, the force increases its value quite rapidly, which results from the sinking of the tools into the rolled part. Once the ring-shaped groove is formed on the rolled part, the force value stabilizes and remains constant. In this stage, necks adjacent to the middle step are being formed. The moment the extreme neck of the shaft begins to be formed, a gradual increase in the value of the rolling force is observed again, which is caused by a further reduction of the cross section and by the upsetting of the middle step of the shaft. During sizing, which is the final stage of the process, irregularities of the workpiece shape are removed, yet particular cross sections do not undergo any

changes; consequently, a quite sudden decrease in the value of the rolling force can be noted.

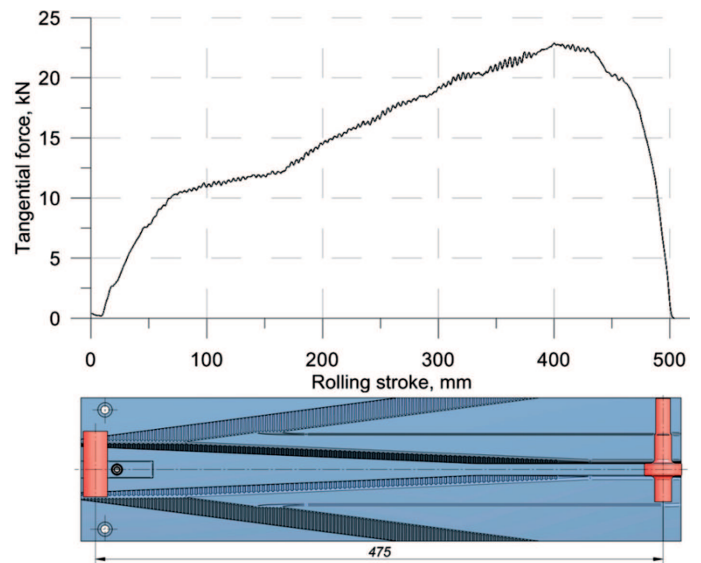

Fig. 14. Force distribution in rolling of shaft with increased middle area

5. Conclusions

On the basis of the conducted analysis, it can be claimed that cross wedge rolling with upsetting can be used to form axially symmetric stepped shafts which have at least one step whose diameter is larger than the billet diameter. The thermo-mechanical numerical analysis of cross wedge rolling with upsetting was performed using the finite element method (FEM) in a three-dimensional state of strain. In the simulations, the technological and tool design assumptions were preliminarily confirmed to be correct, the material flow kinematics was measured, and the effect of the selected forming parameters (α , β , δ and x) on the diameter increase ratio ξ and the volume ratio V_1/V_0 was investigated. It was found that the diameter of the upset step, defined by the increase ratio ξ and the volume ratio V_1/V_0 , increased most due to the effect of the following parameters: the value of the forming angle α (an increase in its value makes the upsetting process more efficient); the value of the spreading angle β (a decrease in its value makes the values of ξ and V_1/V_0 increase); the reduction ratio δ (an increase in the value of δ leads to an increase in the diameter value of the upset step). In contrast, the rolling length x exerts a much less significant effect on the diameter increase of the step which undergoes upsetting.

The obtained results were verified in experimental tests. In the experiments, both the process stability conditions and phenomena impairing product quality were investigated. Due to their technological significance, the force parameters were investigated as well.

Summing up, it can be observed that the developed process makes it possible to form axially symmetric stepped axes and shafts, the rolled part having different diameter dimensions of each step, which is not possible to obtain in the standard CWR processes. Consequently, such parts can be formed in one tool pass, which considerably simplifies the

production process as well as reduces both material and energy consumption.

Acknowledgements

This research work has been made as part of Project no. POIG.0101.02-00-015/08 titled "Modern Material Technologies Used in the Aerospace Industry" under the Innovative Economy Operational Programme (IEOP). The research project has been co-financed by the European Union from the European Regional Development Fund.

REFERENCES

- [1] Z. Pater, *Walcowanie poprzeczno-klinowe*. Wydawnictwo Politechniki Lubelskiej, Lublin 2009.
- [2] J. Bartnicki, Z. Pater, The aspects of stability in cross-wedge rolling processes of hollowed shafts. *Journal of Materials Processing Technology* **155-156**, 1867-1873 (2004).
- [3] Z. Deng, M. Lovell, K. Tagavi, Influence of Material Properties and Forming Velocity on the Interfacial Slip Characteristics of Cross Wedge Rolling. *Journal of Manufacturing Science and Engineering* **123**, 647-653 (2001).
- [4] Z. Pater, W. Weron ski, *Podstawy procesu walcowania poprzeczno-klinowego*. Wydawnictwo Politechniki Lubelskiej, Lublin 1996.
- [5] X.H. Xi u, On rotary conditions of rolled parts in cross wedge rolling. *J. Univ. Sci. Tech. Beijing* **1**, 50-56 (1991).
- [6] Z. Pater, A. To fil, *Walcowanie poprzeczno-klinowe wałka ze zgrubieniem końcowym*. *Hutnik, Wiadomości Hutnicze* **8**, 650-654 (2011).
- [7] Z. Pater, Numerical simulation of the cross wedge rolling process including upsetting. *Journal of Materials Processing Technology* **92-92**, 468-473 (1999).
- [8] V.A. Kl u š i n, E.M. M a k u š o k, V.Ja. Š c u k i n, *Soveršenstvovanie poperečno-klinovoj prokatki*. Minsk: Nauka i Technika 1980.
- [9] X. L i, M. W a n g, F. D u, The coupling thermal – mechanical and microstructural model for the FEM simulation of cross wedge rolling. *Journal of Materials Processing Technology* **172**, 202-207 (2006).
- [10] Z. Pater, Cross-Wedge Rolling of Shafts with an Eccentric Step. *Journal of Iron and Steel Research, International* **18** (6), 26-30 (2011).
- [11] Z. Pater, A. To fil, Experimental and theoretical analysis of the cross-wedge rolling process in cold forming conditions. *Archives of Metallurgy and Materials* **52**, 289-297 (2007).