

A. MAMALA*, P. KWAŚNIEWSKI*, A. NOWAK*, J. GRZEBINOĞA*[#], W. ŚCIEŹOR*, R. KOWAL***EFFECT OF METALLIC ADDITIVES TO POLYMER MATRIX ON PROPERTIES OF COMPOSITE ADHESIVES DEDICATED FOR LIGHT METAL JOINING**

The most recent and promising trends in development of renewable sources of energy are Combined Heat and Power (CHP) systems. The newest solutions from this field are hybrid compact solar panels. The correct operation of both systems, i.e. the photovoltaic panel and the heat exchanger requires an effective connection between the two. The adhesives utilized to interconnect above elements should provide a stable and hermetic joint able to withstand mechanical and thermal impacts of the surrounding environment factors. The paper presents the research results over the impact of the type and the amount of reinforcing phase on the physical and mechanical properties of epoxy resin matrix composites reinforced with particles of non-ferrous metals (Ag, Cu, W, Al), dedicated as adhesives for connections between photovoltaic panels and heat exchangers. Based on the experimental findings the usefulness of classical analytic models for valuation of polymer-metal composites properties was validated.

Keywords: polymer-metal composites, thermal conductivity, epoxy matrix adhesives, reinforcement with particles of non-ferrous metals

1. Introduction**The reason behind the work:**

The current issues associated with solar energy and photovoltaics are the subject of intensive research carried out by scientific and design institutes all over the world. Based on the literature analysis there are noticeable principal directions these studies are following, namely the work on increasing the part of energy from solar radiation by searching for new materials and constructions and also working on increasing the reliability of the developed structures. The newest CHP solutions – combined heat and power systems are the hybrid compact solar panels. These panels partly convert the solar radiation that reaches to the Earth's surface into electrical energy in photovoltaic panels. Simultaneously generated, the waste heat is used to heat up the water in the central heating and DHW (domestic hot water) systems through a special plate heat exchanger. The combination of a photovoltaic panel and a thermal collector allows for better management of space in solar installations and a more efficient way of utilizing the waste heat from the PV cells as well as direct supply of energy to the electric appliances.

Research problem:

One of the key issues in the research conducted to develop a new generation of hybrid compact solar panels is the development of the appropriate adhesive for the photovoltaic panels and plate heat exchangers joints. The adhesives used in such

constructions should guarantee high efficiency in heat transfer, provide high adhesive properties and have a significant flexibility. They should show the lack of property degradation over time and during temperature and environmental factors exposure. The thermal conductivity of these adhesives should be as high as possible as to reduce the losses of the waste heat in the hybrid collector. Conventionally used adhesives with classical polymer matrices show a relatively low thermal conductivity at the level of 0.2-0.6 W/mK [1].

The use of powder additives of various chemical compositions to enrich the additives results in the increase of adhesives thermal conductivity properties. Usually the improvers are the metal powders obtained from copper (Cu), silver (Ag) [2] or ceramics [3]. The main factors determining the choice are not only the physical properties (high thermal conductivity) and mechanical strength but also economic issues.

Epoxy resins show excellent adhesion to most materials such as metals, ceramics or glass, and the epoxy matrices of the formed composites after hardening have satisfactory mechanical properties.

2. Materials and experimental work

The tests were conducted on composites synthesized on epoxy resin matrices with aluminum, copper, silver and tungsten additives. Also, the tests were carried out for composites

* AGH UNIVERSITY OF SCIENCE AND TECHNOLOGY, FACULTY OF NON-FERROUS METALS, 30 MICKIEWICZA AV., 30-059 KRAKÓW, POLAND

[#] Corresponding author: jgr@agh.edu.pl

synthesized on the epoxy resin matrices without additives as a reference material. An epoxy resin is a product obtained in reaction of bisphenol with epichlorohydrin in alkaline medium with an average molecular weight of ≤ 700 and the epoxide equivalent of 0,51-0,54 mol /100 g. The triethylenetetramine as hardening agent is usually used. In the research the commercial Epidian 5 and cure agent Z1 were used. Non-ferrous metal powders were used in the synthesis of the composites: silver with purity 99,96% minimum and APS < 15 μm , copper with purity 99,7% minimum and APS < 45 μm , tungsten with purity of 99,9% minimum and APS < 8 μm and aluminum with purity 99,8% minimum and APS < 45 μm .

The composite samples were prepared by mixing the resin and a hardener in a ratio of 1:10 with the metal fraction for at least 360s, than the mixture was poured into a cylindrical form where the hardening process took place. In the discussed case the hardening processes of polymers is exothermic. The mass of the composite sample and the shape of the form facilitated heat transfer into the environment. Additionally, the metal filling absorbed the part of the heat generated in the reaction. As a result, the temperatures of the synthesis of the studied composites were lower than classical temperatures of resin hardening. Mixtures with 5 wt. % of each additive and mixtures with the content of additives (52.4 wt.% Al, 59.5 wt.% Cu and 15.3 wt.% W) were made. Higher content of this additives was to show the impact of the increased additive volume in the compound. The contents of additives were as follows: 1, 16, 32%.

The obtained compounds were examined in terms of their physical properties, i.e. density tests, elastic constant tests and thermal conductivity tests. The tests were also carried to examine the mechanical properties of obtained adhesives, including the Vickers hardness tests and the static compression test.

The density measurements were made by the Archimedes method – by measuring the weight of a sample in the air and in

distilled water using a laboratory BS Mettler Toledo scales with a “density kit” attachment, using the classical relationship (1):

$$\rho = \frac{A}{A-B}(\rho_o - \rho_l) + \rho_l$$

where: A – the mass of the sample in the air, B – mass of the sample in a liquid, ρ – the composite’s density, ρ_o – the liquid’s density at the measuring temperature (the study considered a correction due to the change of the density of water with the change in temperature), ρ_l – air density equal to 0.0012 g/cm^3 .

The elastic constants of the composites were estimated by the ultrasonic method using longitudinal and transverse waves. Knowing the overall dimensions of the examined object and the transition time of an ultrasonic wave through the sample the speed of sound in a tested material can be estimated. The error of the ultrasonic method is about 1%. The echo method was used in the research. It uses a transmitter head that records the time between sending a sound signal from the head and its return after it reverberates from the object’s surface. In the research of the elastic constants of the composites the EPOCH XT Olympus ultrasonic device and the longitudinal and transverse wave heads: V1091 and V157 were used. Additionally, the impact of the frequency of an ultrasonic wave on the speed of sound in the tested reference material was examined. Literature data sometimes show a little influence of the frequency on the speed of the ultrasonic sound in the resins, it depends on their curing stage [4].

Figure 1 shows the test results of the transition times of the ultrasonic waves of different frequencies through an epoxy resin without metallic additives together with the longitudinal wave velocity calculated based on the findings.

The analysis of the results suggests a slight upward trend in the speed of sound as a function of the increase in the frequency of the signal. The attenuation is clearly visible with the increas-

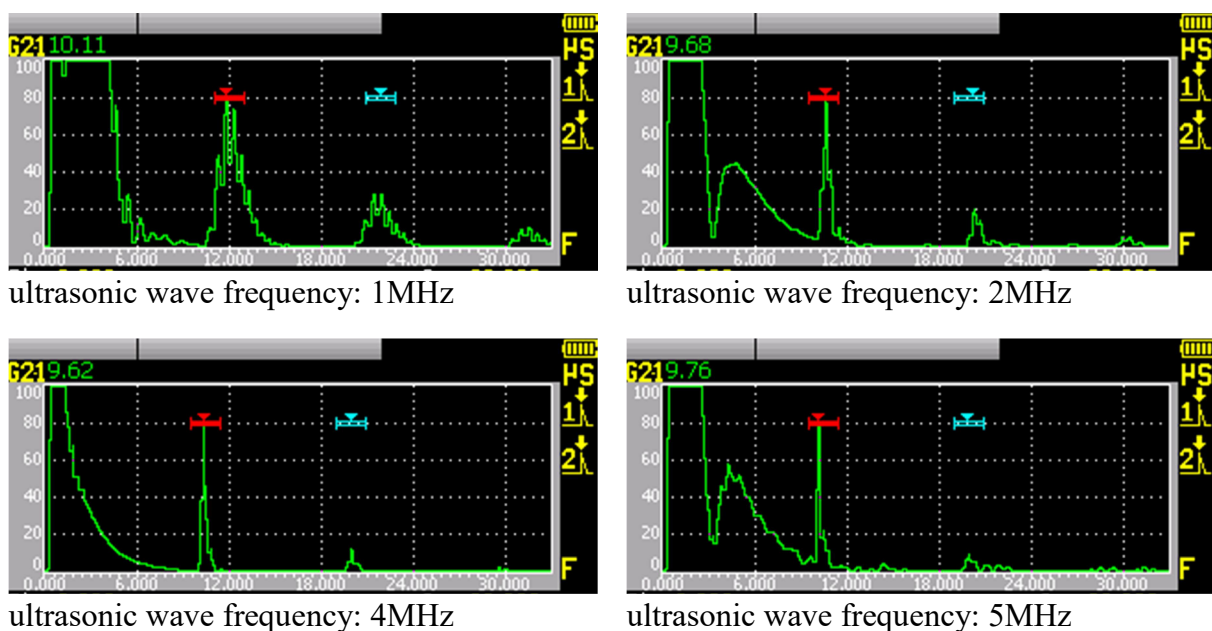

Fig. 1. Ultrasonic test results for the wave frequencies: 1,2,4,5 MHz of epoxy resin test sample, echo method, sample thickness 12.74 mm

ing frequency. In the pictures the height of the first echo wave was always captured at the level of 80%. The peak representing the second reflection clearly decreases with the increase of frequency to approximately 30% to less than 10% of the range. The observed speed of sound spread for the test frequency range is approximately 5% of the average.

The calculation algorithm of the elastic constants based on the measurements of the transition time of the ultrasonic wave through the tested sample is as follows (2):

$$V_w = \frac{4H}{T_{w1-3}}, V_p = \frac{4H}{T_{p1-3}}, \nu = \frac{1-2\left(\frac{V_p}{V_w}\right)^2}{1-2\left(\frac{V_p}{V_w}\right)^2},$$

$$E = \rho V_w^2 \frac{(1+\nu)(1-2\nu)}{(1-\nu)}, G = \rho V_p^2, K = \rho V_w^2 \frac{(1+\nu)}{3(1-\nu)}$$

where: V_w – the speed of sound – longitudinal wave, V_p – the speed of sound – transverse wave, H – sample height, T_{w1-3} – transition time – longitudinal wave, T_{p1-3} – transition time – transverse time, ρ – density, ν – Poisson’s coefficient, E – Young’s modulus, G – Kirchhoff’s modulus, K – Helmholtz’s modulus.

Due to the potential level of heat conductivity of the examined composites (higher than the conductivity of resins and

significantly lower than the conductivity of metals) the value was calculated directly from the Fourier law (converted to the finite differences) using the method of direct measurement of the temperature gradient in the sample under static heat flux conditions. The advantage of this method is no need for additional determination of physical parameters of the examined material. A similar measurement technique to determine the thermal conductivity of polymer-metal composites is described in [5-6]. For measuring purposes instrumentation as shown in Figure 2 was used. The heat source is a resistor with predefined resistance, through which the current with known intensity and voltage flows. Given this data it is easy to calculate the heat energy (Joule heating). A part of the heat flows through the copper cylinder, the test sample and another copper cylinder with a cooler. Because it is difficult to estimate the amount of heat flowing through the sample due to partial losses to the environment, the method of comparison was used to estimate the heat flux by the method of reversed equations based on the test data obtained from a test sample of known thermal conductivity. The heat flux through the test sample was independently controlled and the flow and the temperature increase in the copper cooler were recorded. The source of the electrical energy was the MO-TECH programmable, stabilized DC power supply. To record the data (current, voltage, temperatures, flow rate) and to control the flow pump a special multichannel controller/recorder of the electric signals was used.

The dependency of the thermal conductivity under static conditions can be expressed as (3):

$$\lambda = \frac{Q}{tA} \frac{\Delta x}{\Delta T} = \dot{q} \frac{l}{\Delta T}$$

where: λ – thermal conductivity of the material, Q – heat transfer, T – temperature, x – heat transfer direction (perpendicular to the unit area used to estimate the density of the heat flux), t – time, A – heat transfer area (the cross-section of the test sample), \dot{q} – heat flux density (heat rate per unit area) l – sample length.

The hardness test of the composites was carried out by the Vickers method with a load of 10 kg and the testing time of 10 seconds using an automatic, universal hardness tester – Tukon 2500 Wolpert-Wilson. Pictures of the indentations were taken to identify the potential cracks around the sample corners, which enabled to estimate the susceptibility of the test material to brittle fracture.

The compressive characteristics of the composites were tested in Zwick/Roell Z020 universal testing machine after it had been adjusted to allow for compression tests. The sample dimensions were as follows: $H = 6 \text{ mm}$, $D = 6 \text{ mm}$. The speed of compression for the composites was 1 mm/min.

3. Results and discussion

Table 1 shows the results of specific density measurements and the calculated theoretical density for epoxy resin and composites of resin and metallic additives.

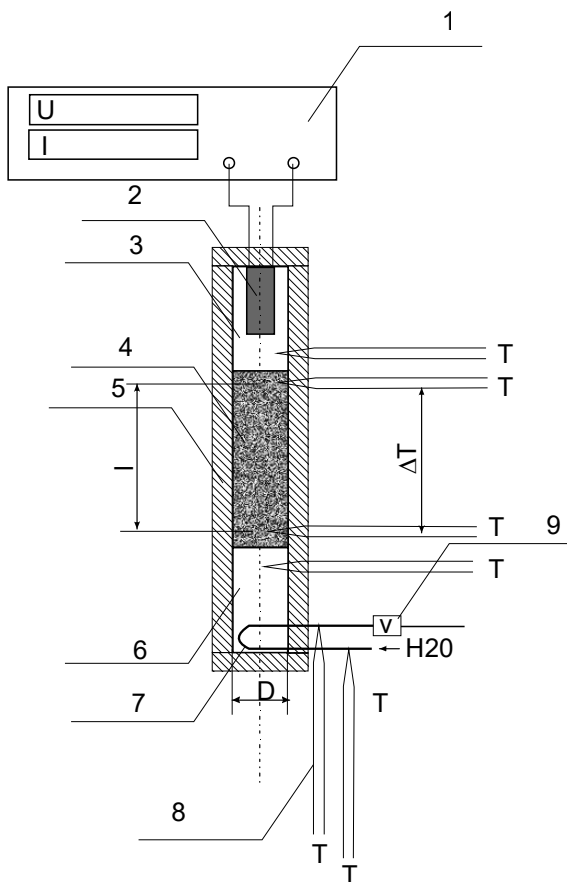

Fig. 2. The initial concept of the test equipment setup (1 – power supply, 2 – cartridge heaters, 3 – copper cylinder, 4 – tested sample, 5 – insulation, 6 – copper cylinder, 7 – water cooler with a choke valve, 8 – temperature sensors, 9 – flow-rate sensor or a dosing pump)

Specific density measurement and theoretical density calculation results

Sample	Resin density [g/cm ³]	Additive density [g/cm ³]	Additive amount [% of mass]	Additive amount [% of vol.]	Theoretical density of the composite [g/cm ³]	Density of the test sample [g/cm ³]	Specific density/theoretical density
epoxy resin	1,18	0	0	0	1,20	1,18	0,99
5,0%Ag	1,20	10,49	5	0,60	1,26	1,25	0,99
5,0%Cu	1,20	8,93	5	0,70	1,25	1,24	0,99
5,0%Al	1,20	2,70	5	2,29	1,23	1,22	0,99
5,0%W	1,20	19,3	5	0,33	1,26	1,24	0,99
15,3%W	1,20	19,3	15,3	1,11	1,40	1,34	0,96
59,5%Cu	1,20	8,93	59,5	16,49	2,47	2,42	0,98
52,4%Al	1,20	2,70	52,4	32,85	1,69	1,57	0,93

The actual densities of the tested composites are very similar to theoretical values calculated by the rule of mixtures, which can be simplified to the following (4) (assuming two elements in the compound):

$$\rho = \frac{m}{V} = \frac{m_x + m_y}{\frac{m_x}{\rho_x} + \frac{m_y}{\rho_y}}$$

where: m – total weight of the composite, V – the volume of the composite, m_x, m_y – the weight of the elements in the composite (the matrix and filling part by weight), ρ_x, ρ_y – the densities of the elements in the composite.

Only when the volume of the metal reinforcement phase is great the specific density is significantly lower than the theo-

retical. It is most likely related to the specific viscosity of the liquid phase of the resin during the synthesis and sealing the air between the metal particles. The micro-bubbles of air can also be trapped in the liquid phase of the resin.

Table 2 shows the results of the elastic constant for the examined composites.

The elastic constants calculated for the epoxy resin are comparable to the values known from other studies [7]. The analysis of the data shown in Table 2 leads to a conclusion that reinforcing the epoxy matrix with the metallic additives results in the increase in the elastic modulus and the Kirchhoff's modulus. The increase is greater the higher is the volume of the additive in the composite (see Table 1 for reference). The test results for samples with higher metallic additive contents show that

TABLE 2

The elastic constant test results for the examined compounds

Sample	Speed of sound, longitudinal wave [m/s]	Speed of sound, transverse wave [m/s]	Poisson's coeff. [-]	Young's Modulus [GPa]	Kirchhoff's Modulus [GPa]	Helmholtz's Modulus [GPa]
Epidian	2477	1158	0,33	5,52	1,67	5,33
Epidian+5%Ag	2456	1161	0,32	5,46	1,68	4,94
Epidian+5%Cu	2518	1187	0,31	5,44	1,69	4,80
Epidian+5%Al	2510	1170	0,31	5,60	1,74	4,98
Epidian+5%W	2477	1158	0,32	5,60	1,72	5,10
Epidian+15,3%W	2428	1143	0,31	5,90	1,83	5,27
Epidian+59,5%Cu	2041	1006	0,29	7,81	2,50	6,28
Epidian+52,4%Al	2746	1299	0,31	9,18	2,86	8,10

TABLE 3

Comparative analysis of the measured and calculated elastic modulus for the examined composites (source MatWeb database)

Sample	Matrix Young's Modulus [GPa]	Reinforcement Young's modulus [GPa]	Young's modulus – measured [GPa]	Young's Modulus – calculated in acc. with Voigt [GPa]	Young's Modulus – calculated in acc. with Reuss [GPa]	Measurement calcs. in acc. with Reuss
epoxy resin	5,52	—	5,52	—	—	—
5%Ag	5,52	76	5,46	5,94	5,55	1,02
5%Cu	5,52	110	5,44	6,25	5,56	1,02
5%Al	5,52	68	5,60	6,95	5,64	1,01
5%W	5,52	380-400	5,60	6,48	5,54	0,99
15,3%W	5,52	300	5,90	6,30	5,58	0,95
59,5%Cu	5,52	110-130	7,81	22,8	6,54	0,84
52,4%Al	5,52	68	9,18	26,1	7,91	0,86

the average increase in the elastic modulus for every 1% of the additive volume is greater the higher the Young's modulus of this additive. The Poisson's ratio is similar for all of the materials tested, and is only lower for the sample with the highest Cu content. It is important to note that copper strongly suppresses the propagation of elastic oscillations, which greatly affects the facility of the measurement. In this respect, the observed deviation may be due to the limitations of the measurement method. The Helmholtz's modulus should show a similar trend to the Young's modulus with the quasi-constant Poisson's ratio. The measurement results are not part of this relationship most likely due to the fluctuations in the measured values of Poisson's ratios. Only with the significant amount of the reinforcement phase in the composite the Helmholtz's modulus is substantially higher than for the pure epoxy matrix.

The analysed ultra-fine particle composites are a combination of metal particles in the epoxy resin matrix. Due to the temperature range of the binding resin and the chemical reactions the diffusion processes between the matrix and the reinforcing phase do not occur. Because of this phenomenon, the classical relationship based on the rule of mixtures can be used for the quantitative description of the basic physical properties of the composites. The basic elastic constant of a material, i.e. the Young's modulus can be determined for this type of composites using the Voigt and Ruess models [8] and is close to the arithmetic average of the values calculated from these two models. Limitations of the Voigt and Ruess models and examples of its application to the composite with the particle reinforcement like other analytical formulas can be found in [9]. The difference between the two results from the different assumptions in the two methods. Voigt assumed the identity of deflection of the individual composite elements and the elastic modulus calculated his way is a sum of the products of elastic moduli and the volume fraction of the individual phases. Reuss, in turn, assumed the stresses were the same in the considered phases. Quantitatively, according to his model, the reciprocal of the composites Young's modulus is a sum of the shares of volume and the Young's moduli of the composite materials ratios. Therefore, Voigt's model can be treated as a model in which the composite is made from layers that represent different components and are connected in paral-

lel. Reuss's model assumes a series connection of these layers. Table 3 shows the measured values of the Young's moduli and the values calculated using Reuss's and Voigt's models. A comparison of the results shows that the closes estimation of the actual values is obtained directly from the Reuss's model. For the two-component composites the formula is as follows (based on rule of mixtures) (5):

$$E = \frac{E_x E_y}{E_x \phi_y + E_y \phi_x}$$

where: E – composite Young's modulus, E_x, E_y – Young's modulus for the composite components, i.e. the reinforcing phase and the matrix, ϕ_x, ϕ_y – the volume fraction of the composite components.

Some discrepancy between the theoretical estimation and the measured values for the composites with high metal content could be a result of the increased difference between the theoretical and specific density of the compound materials, or the privileged location of the potential gas micropores in the composite.

Figures 3 and 4 show the examples of chosen process parameters during the measurements of thermal conductivity. Table 4 summarizes the empirically determined thermal conductivity properties for the examined composites.

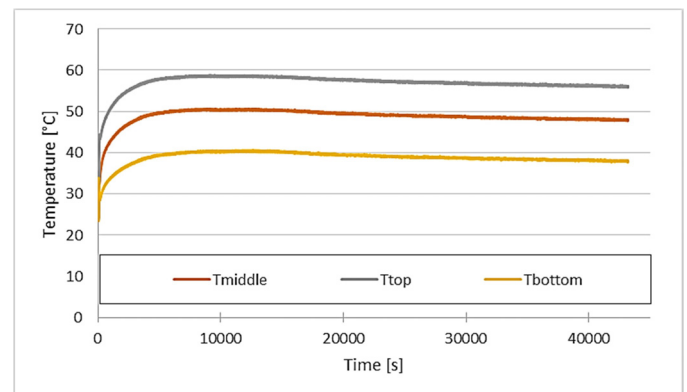

Fig. 3. The temperature change against the heating time for the epoxy resin + 52.4wt% Al sample, \varnothing 20 mm \times 22 mm. (T_{Top} – measurement at the surface in contact with the heater, T_{middle} – measurement at the middle of the sample height, T_{bottom} – measurement at the surface in contact with the cooler)

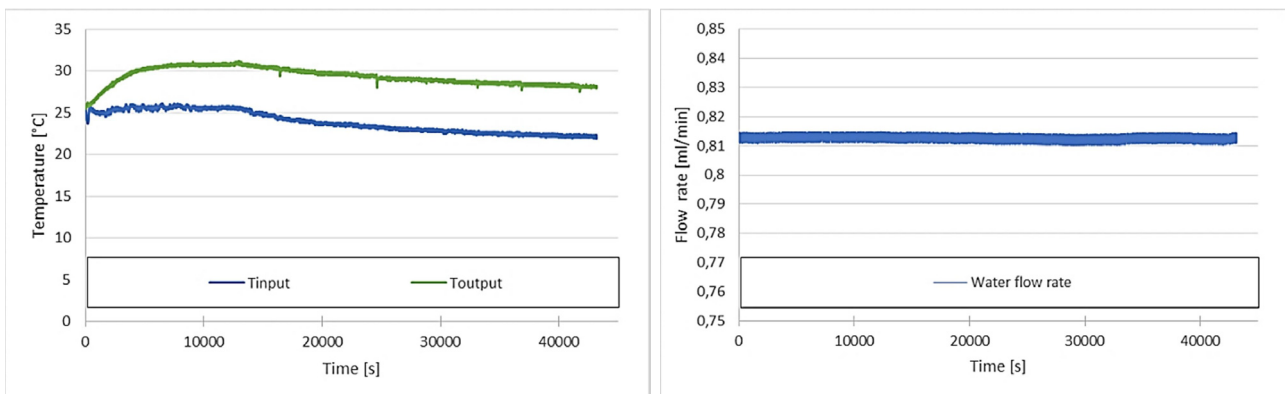

Fig. 4. The water temperature change in the cooling circuit against the heating time for the epoxy resin + 52.4% Al sample, \varnothing 20 mm \times 22 mm (left) and the flow stability plot (right)

The results of thermal conductivity measurements for the examined composites and the values calculated in accordance with Maxwell's conductivity model

Sample	Measured thermal conductivity [W/mK]	Thermal conductivity of resin [W/mK]	Thermal conductivity of metals [W/mK]	Composite thermal conductivity calculated in acc. With Maxwell's model [W/mK]	Measured-to-theoretical conductivity ratio
epoxy resin	0.185	0.185	—	0.185	1.00
5,0%Ag	0.222	0.185	419	0.189	1.17
5,0%Cu	0.189	0.185	385	0.190	1.00
5,0%Al	0.225	0.185	210	0.201	1.12
5,0%W	0.189	0.185	163	0.187	1.01
15,3%W	0.189	0.185	163	0.193	0.98
59,5%Cu	0.270	0.185	385	0.424	0.64
52,4%Al	0.387	0.185	210	0.408	0.95

Figures 3 and 4 show the temperature changes and the time required for thermal stabilization of the system. The temperature of the samples was measured in the vicinity of their top and bottom surfaces, and also, for control purposes – at the middle of the sample. The observed temperature gradient over the height of the sample was approximately 18.4°C. The maximum temperature did not exceed 59°C. This guaranteed the test was carried out in the operating temperature range of the resin, below its glass transition temperature.

The volume fraction of the metal reinforcement in the tested composites was generally low. It only resulted in minor changes in the thermal conductivity of the aforementioned composites. The findings of the thermal conductivity research for the composites with polymer matrices and ceramic and metal reinforcements can be found in [2]. For ceramics refer to [3]. Due to the nature of the composites, the thermal conductivity can be quantitatively modelled using Maxwell's methods. It is a model that describes the thermal conductivity of the composites filled with fine spheroidal particles evenly distributed throughout the volume of the composite. For a two-component composite the thermal conductivity can be calculated using the following formula (6):

$$\lambda = \lambda_x \left(1 + \frac{3\phi_y}{\frac{\lambda_y + 2\lambda_x}{\lambda_y - \lambda_x} - \phi_y} \right)$$

where: λ_x, λ_y – thermal conductivity coefficients of the matrix and the reinforcement phase, ϕ_x, ϕ_y – the volume fraction of the composite components

Table 4 summarizes the empirically determined thermal conductivity coefficients for the composites and the conductivity estimated based on the Maxwell's method. The recorded experimental thermal conductivity values for the examined materials range from 0.185 W/mK for the pure epoxy resin to 0.387 W/mK for the composite containing 52.4wt% of Al. The conductivity coefficients estimated based on the Maxwell's model were slightly different to the measured values and ranged from 0.185 W/mK for epoxy resin, through 0.189 W/mK for the composite contain-

ing 5wt% of copper and 0.187 W/mK for 5wt% of tungsten to 0.408 W/mK for 52.4wt% of aluminium. Approximately, a 98% convergence between the experimental results and the theoretical calculations was obtained. More information on the modelling of the thermal conductivity of composites can be found in [10-11].

Figure 5 presents the hardness test results determined by the Vickers method. Figure 6 shows a photographic documentation of the indentations in selected materials (pure resin and a composite with a high content of a metallic additive).

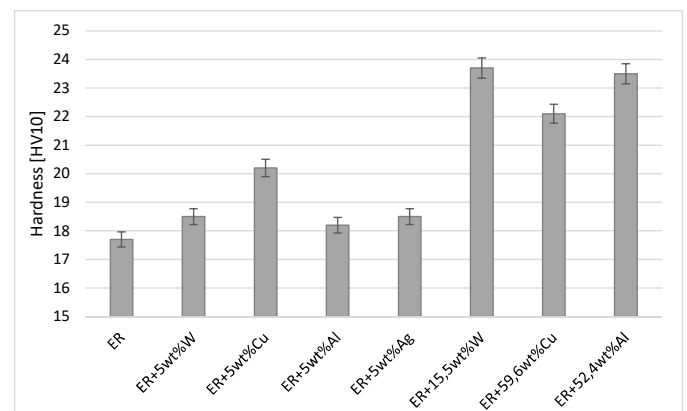
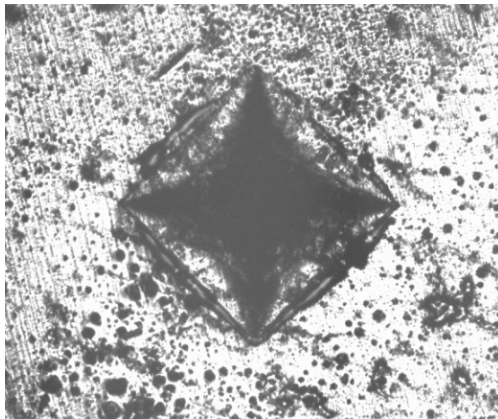

Fig. 5. Vickers hardness test results (HV10) for the examined composites

The results show (refer to Figure 5) that the addition of the metal fraction up to 5% of the total weight does not affect the hardness significantly. A certain increase in hardness (approximately 30%) is observed with higher contents of the additives. Figure 6 shows the indentations present in the sample after the Vickers hardness test was performed. There are no signs of crack propagation at any of the indentations corners. This indicates the composites show high resistance to brittle fracture [12].

Figure 7 shows the results of the static compression test for the examined composite samples. They all proved to have good elastic properties and high resistance to permanent deformations. The compression test stress-strain plots are typical to materials with characteristic inflection point occurring at low strain values and the stress increase as the strain grows [13-14]. The nature of the compression curve is often associated with the nature of the



epoxy resin

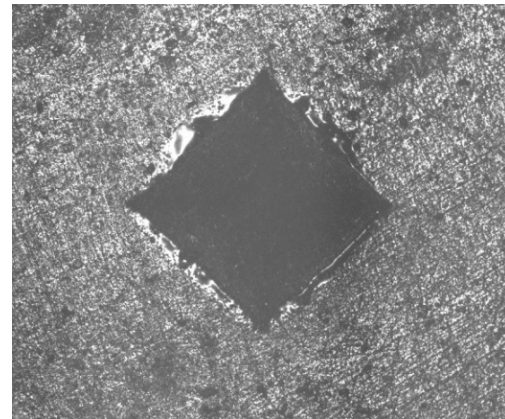

epoxy resin + 59,5wt%Cu

Fig. 6. Photographs of the indentations after Vickers hardness tests

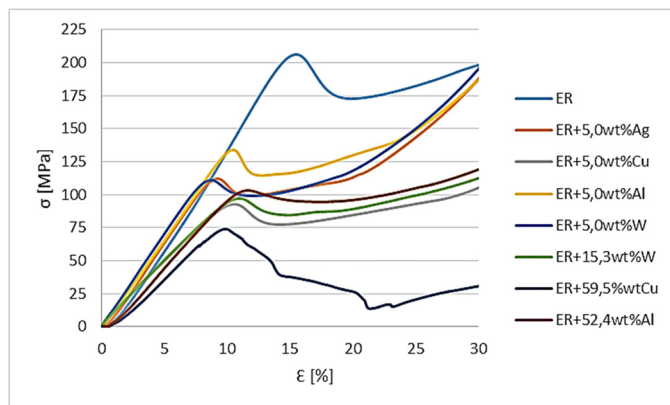

Fig. 7. Stress-strain curves for the composites in compression

crack propagation in the epoxy matrices – sometimes it is continuous and sometimes pulsating [15]. The addition of the metal phase accelerates permanent deformations of the composites.

4. Summary

The density of the matrix is substantially lower than the density of the metallic additives, which can result in a gravitational segregation of the particles and in the risk of uneven distribution of the reinforcing phase within the composite. The density difference between the polymer matrix and the reinforcement translates into the increased density of the final composite. Even substantial metal weight fractions result in their smaller volume fractions, and the latter largely determine the properties of the composite. It is thus difficult to obtain composites with significantly different properties than the matrix, especially with small amounts of the additives.

Despite the aforementioned issues, the addition of non-ferrous metals to the epoxy matrix allows for producing adhesives with a significant utilitarian potential. The metallic additives substantially increase the Young's modulus and to some extent, the hardness of the composite. This is an added value in case the adhesives are subject to mechanical loads during operation.

They can be utilized to combine elements made from materials with different thermal expansion coefficients used in the hybrid solar collectors (the operating temperature for those ranges from -30°C to $+100^{\circ}\text{C}$). With the better mechanical properties the thickness of the adhesive layer in the joint can be reduced. Furthermore, the metallic phase in epoxy metal composites can increase its thermal conductivity that in combination with the thinner layer of composite in multilayer partition can positively impact the heat exchange.

Due to the nature of the synthesis process and the type of substrates, the examined polymer-metal composites constitute a mixture of two components, in which the combination of the two phases is physical. In this respect, the basic properties of these composites can be estimated using classical models based on the rule of mixtures.

Acknowledgements

This paper was produced as part of PBS3/B9/27/2015 project financed by the National Research and Development Centre

REFERENCES

- [1] Y. Takezawa, M. Akatsuka, C. Farren, High thermal conductive epoxy resins with controlled high order structure, Proceedings of the 7th International Conference on Properties and Applications of Dielectric Materials, Nagoya, Japan, June 1-5, 1146-1149 (2003).
- [2] F.F.T. Araujo, H.M. Rosenberg, The thermal conductivity of epoxy-resin/metal-powder composite materials from 1.7 to 300K, Journal of Physics D: Applied Physics **9**, 665-676 (1974).
- [3] I.A. Tsekmes, R. Kochetov, P.H.F. Morshuis, J.J. Smit, Thermal Conductivity of Polymeric Composites: A Review, 2013 IEEE International Conference on Solid Dielectrics, Bologna, Italy, June 30-July 4, 678-681 (2013).
- [4] S.I. Rokhlin, D.K. Lewis, K.F. Graaf, L. Adler, Real-time study of frequency dependence of attenuation and velocity of ultrasonic

- waves during the curing reaction of epoxy resin, *The Journal of the Acoustical Society of America* **79**, 1786-1793 (1986).
- [5] Ł. Wierzbicki, A. Pusz, Thermal conductivity of the epoxy resin filled by low melting point alloy, *Archives of Materials Science and Engineering* **61**, 22-29 (2013).
- [6] F. Rondeaux, Ph. Bredy, J.M. Rey, Thermal Conductivity Measurements of Epoxy Systems at Low Temperature, *Cryogenic Engineering Conference (CEC)*, AIP Conf. Proc. 614, 197 (2002), July 16-20, Madison, Wisconsin, USA (2001).
- [7] A. Smith, S.D. Wilkinson, W.N. Reynolds, The elastic constants of some epoxy resins, *Journal of Materials Science* **9**, 547-550 (1974).
- [8] R. Hill, The elastic behaviour of a crystalline aggregate, *Proceedings of the Physical Society* **65**, 350-354 (1952).
- [9] C.L. Hsieh, W.H. Tuan, Elastic properties of ceramic-metal particulate composites, *Materials Science and Engineering* **393**, 133-139 (2005).
- [10] I.A. Tsekmes, R. Kochetov, P.H.F. Morshuis, J.J. Smit, Modelling the Thermal Conductivity of Epoxy Nanocomposites with Low Filler Concentrations, *Annual Report Conference on Electrical Insulation and Dielectric Phenomena*, Chenzhen, China, Oct 20-23, 699-702 (2013).
- [11] K. Pietrak, T.S. Wiśniewski, A review of models for effective thermal conductivity of composite materials, *Journal of Power Technologies* **95**, 14-24 (2015).
- [12] E. Rocha-Rangel, Fracture Toughness Determinations by Means of Indentation Fracture, *Nanocomposites with Unique Properties and Applications in Medicine and Industry*, Dr. John Cuppoletti (Ed.), ISBN: 978-953-307-351-4, 22-38 (2011).
- [13] J.A.V. Gonçalves, D.A.T. Campos, G.J. Oliveira, M.L.S. Rosac, M.A. Macêdo, Mechanical Properties of Epoxy Resin Based on Granite Stone Powder from the Sergipe Fold-and-Thrust Belt Composites, *Materials Research* **17**, 878-887 (2014).
- [14] J.L. Jordan, J.R. Foley, C.R. Siviour, Mechanical properties of Epon 826/DEA epoxy, *Mechanics of Time-Dependent Materials* **12**, 249-272 (2008).
- [15] S. Yamini, R.J. Young, Stability of crack propagation in epoxy resins, *Polymer* **18**, 1075-1080 (1977).