

**Adam Jan Zwierzyński*, Tomasz Wróblewski*,
Rafał Wiśniowski*, Stanisław Stryczek***

SELECTED METHODS OF MEASURING DRILLING MUD SETTLING**

1. INTRODUCTION

The mud circulation in a rig is sometimes compared to the blood circulation in a living organism because of the vital functions it plays. Drilling mud is important for a number of reasons, e.g. stabilizes wellbore walls, prevents uncontrollable inflow of reservoir fluid and consequently eruption, removes cuttings, lubricates and cools down the drill elements. It can be also used for driving the bit, analogous to the downhole drives. Changes of the mud pressure can be used for sending information. Drilling muds are frequently composed of many constituents to provide specific physical and chemical properties, adjusted to definite wellbore conditions. Frequently the composition is not revealed by the producer and remains confidential [1].

The basic criterium classifying drilling muds is its base, i.e. liquid phase [2, 3]. Water- and oil-based muds dominate in oil industry. The former can be easily prepared and maintained therefore they are most commonly used. They can be adjusted to definite wellbore conditions. Much more expensive are oil-based muds. Mud containing liquid phase usually have to be weighted to provide the appropriate density. For this reason a densifying agent is added in a proper proportion.

Among the most frequently applied densifiers is barite – barium sulfate BaSO_4 of density 4.3 to 4.6 g/cm^3 . This additive is delivered to the rig site in a powdered form (API grain size). Water- or oil-based muds usually have a suspended solid phase in them (liquid solutions of solid phase). Such systems tend to undergo a settling process which brings about a negative effect. Prior to settling the mud has uniform density. At all depth intervals of the wellbore the mud density remains constant.

Pressure exerted by the column of fluid h high is expressed by the formula (1).

* AGH University of Science and Technology, Faculty of Drilling, Oil and Gas Department of Drilling and Geoen지니어ing, Krakow, Poland

** Performed within a contract financed from research program “Badania Statutowe WwNiG AGH”

$$p = \rho \cdot g \cdot h \quad (1)$$

where:

- p – pressure at depth h ,
- ρ – density of fluid,
- g – acceleration of gravity,
- h – height of column of fluid.

With the progressing settling process the distribution of mud density changes in the wellbore. The settling material moves down decreasing the density of the upper layers and increasing the density of the lower layers. This has a disadvantageous influence on the stability of the wellbore and may cause drilling complications. Frequently, the change of mud density profile in a wellbore in the course of the settling processes results in a drop of hydrostatic pressure. If the pressure goes down below the value at which reservoir pressure can be outbalanced, an uncontrollable flux of reservoir fluid followed by eruption may take place.

Problems due to settling frequently appear after idle time, when the upward circulation is re-started. As a consequence of settling processes taking place in drilling mud, which motionlessly fills the wellbore, the upper mud layers have a lower density than the lower parts, where the weighting material has fallen. After re-starting the upward circulation, the denser mud layers from the bottom move up pushing out the thinner mud from the top layers. The obtained mud is treated and disposed in the mud tank, whereas the thick mud is gradually displaced with the new, nominal-density equivalent injected to the wellbore. At a certain point in time the top part of the wellbore is filled with old and highly dense mud and the remaining part is occupied by new mud of nominal density. This results in an increase of hydrostatic pressure, fracturing of absorptive layers and so lost circulations of drilling mud.

The settling processes taking place in the wellbore may also result in the loss of walls stability, mud circulation problems, cementing problems, local narrowing of wellbore diameter, seizures during casing and loss of control over the wellbore. This may lead to the string break-down and drilling of a rat hole (both of which make the undertaking more expensive), and as already mentioned, to the eruption of reservoir fluid. The settling may have a negative effect on the operations performed while drilling a wellbore, therefore many research works all over the world have been done to investigate this phenomenon. What is more, settling takes place not only in static conditions, when the mud does not move, but also when it circulates in the wellbore. In certain conditions this process may be even more intense than in static conditions.

2. MEASURING METHODS

When the mud is flowing, the suspended cuttings undergo settling. The knowledge of kinematics of the settling process is a basis for working out a sound drilling technology. The methods, thanks to which the kinematics of the settling of the cuttings can be investigated, are presented in this paper. The first [3, 4] is the simplest and most commonly applied

measuring method, i.e. static test method for weighting solids. In this method the mud is poured out to a steel container and then placed in a heating chamber. The temperature and time of heating are predefined. After the time elapses, the fluid density is measured in the upper and in the bottom layers. The settling factor SF expressed with equation (2) is defined on the basis of measured mud density values. The principle of this method is presented in Figure 1a. The settling factor $SF = 0.5$ signifies no settling trend for the solid phase. For $SF > 0.52$ the solid phase will have a settling propensity.

Another method [3, 4] lies in measuring settling particles of weighting material with the use of a rotational viscosimeter. In the literature it is abbreviated to VST (Viscosimeter Sag Test). It is used for measuring the dynamic settling of solid particles. It also allows for connecting the measurement result with standard rheological parameters of fluids, measured according to API standards. These parameters can be determined with a standard viscosimeter Fann 35. The density of the mud on the bottom of the cell, previously mixed for 30 minutes, was measured and the obtained value was compared with the entry density of fluid. Thus, the obtained results differ from the ones obtained with other methods and from the field ones. Therefore the method had to be modified. A “shoe” was disposed on the bottom of the cell. It had a sliding surface, which accelerated the settling of solid particles and the collecting of the material in the tank on the bottom of the cell. By using the “shoe” it was possible to increase the sensitivity of the measuring method and obtain more repeatable results. The settling factor expressed with equation (3) is used for determining the settling trend of the solid phase.

$$SF = \frac{MW_{\text{bottom}}}{MW_{\text{bottom}} + MW_{\text{up}}} \quad (2)$$

$$S_r = \exp\left(-k \frac{\Delta MW}{MW}\right) \quad (3)$$

where:

- SF – settling factor,
- S_r – sag tendency factor,
- MW_{bottom} – density of mud in the lower part of the tank,
- MW_{up} – density of mud in the top part of the tank,
- k – correlation constant, for modified test VST equals to 10.9, and for flow loop method 50,
- ΔMW – difference of fluid densities [g/cm^3],
- MW – entry density of fluid [g/cm^3].

The dynamic settling of solids with the use of a flow loop method [3, 4] is considered to be the best measuring technique applied in the oil industry. Thus, the obtained measured results are closest to the ones obtained in the wellbore conditions. The flow loop is presented in Figure 1b. It is a closed circulation system of drilled mud. The mud continuously circulates in the system, thus enhancing circulation in the wellbore conditions. Mud collected in the mixer tank is pumped to a test section, from which it returns to the tank.

The test section consists of two pipes: the first one of bigger diameter and the other one (of smaller diameter), which is placed inside of the first one. The inner pipe can be rotated, which stimulates the rotation of the string during drilling operation. The rotation rate can be predefined, analogous to the eccentricity of the pipes. The settling processes take place in the test section. Measuring devices recording the density of the flowing mud are installed at both ends of the section. With the ongoing settling, the density of mud will lower and the weighting material will settle in the test section. The data acquisition is realized continuously by a computer-controlled measuring system.

This method can be used for measuring the settling processes for various mud flow rates, rotational rates of inner pipe, tilts and degrees of eccentricity. The first such flow loops were construed in the early 1990s. Originally, they were used in experiments testing the cleaning of the wellbore bottom, and the settling of particles was observed only marginally. Presently the flow loops are used by mud companies and some universities in experiments oriented to new recipes of settling-resistant muds. According to the authors, this method has great potential and can be further improved by introducing additional measuring systems.

a)

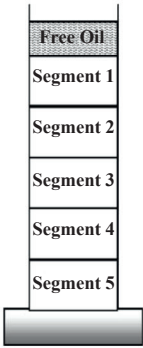

b)

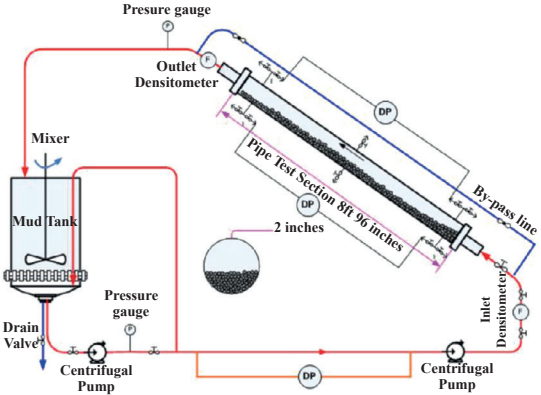

Fig. 1. The static [4] sag test is performed by measuring the density of fluid segment 1 and 5 that is placed in a steel cell which is exposed to relevant temperature (a). Instrumented [4] flow-loop used to determine sag as an effect of pipe eccentricity and rotation (b)

Another device [3, 4] used for measuring settling processes is the Dynamic High Angle Test Device (DHAST) – see Figure 2. It was designed for simulating actual wellbore conditions. It accounts for the influence of temperature, pressure and rotation of the string on the settling processes taking place in the drilling mud. The analyzed fluid is disposed in a settling pipe and subjected to the predefined temperature and pressure. The settling pipe is placed on a pin, and the angle of tilt can be regulated. Gradually as the solid particles settle down, the gravity center of the pipe containing the mud changes its position. This can be observed through a change of the moment of force acting in pins supporting the pipe under a given angle. Such changes are registered as a function of time. A function expressed as (4) is adjusted to the registered measurement data. If the measurement was realized in time $0 \leq t \leq \tau$, then the settling coefficient SC can be calculated from equation (5).

$$X_{cm}(t) = \frac{A}{B + t} \quad (4)$$

$$SC = \int_{t=0}^{\tau} X_{cm}(t) dt \quad (5)$$

where:

- A – maximum shift of gravity center,
- B – time needed for gravity center to reach position $A/2$,
- t – time from the beginning of measurement,
- SC – settling coefficient.

This corresponds to the total number of particles which had settled during the measurement time on the bottom of the pipe. The value of SC cannot be arbitrary. This is caused by the limited volume and geometry of the tank with the analyzed mud. For this reason SC has its lower and upper boundary.

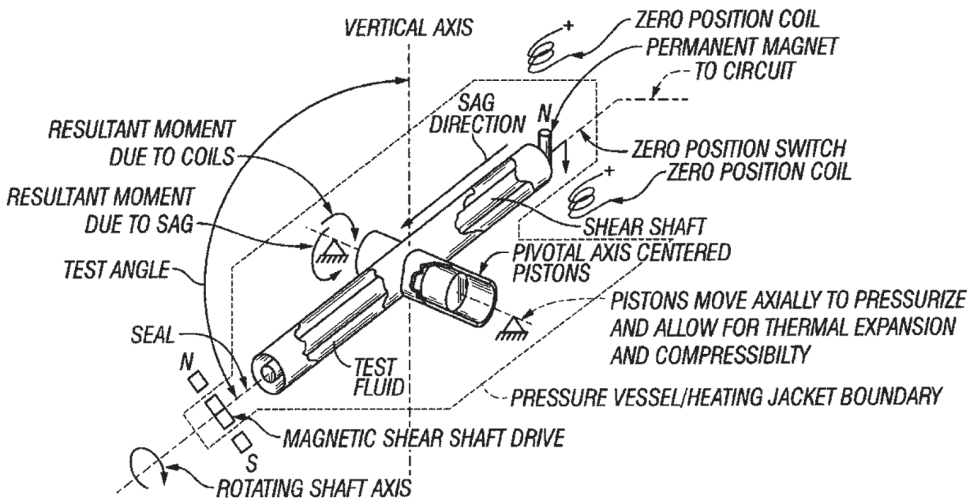

Fig. 2. The DHAST measures the change in center of mass providing information of the fluids sag stability [4]

Ultrasonic methods, which are very popular in food industry settling measurements, can be also employed for analyzing settling process in drilling mud [3, 4]. This type of method is based on a dependence between ultrasonic wave reflection and velocity of wave propagation in base liquid, density of liquid and also of transverse and longitudinal wave propagation in a liquid that reflects the signal. The magnitude, shape and concentration of solid particles dispersed in the fluid also have influence on the signal of the reflected ultrasonic wave. The principle of measurement is presented in Figure 3a. This method is commonly

applied in industry for settling measurements, however in the case of drilling muds which have a high concentration of solids the direct dependence between the concentration of these particles and dying of the acoustic wave in the analyzed fluid is difficult. This is caused by the fact that the acoustic wave is scattered by the interacting solid particles and also other complex effects. This created problems with the interpretation of obtained results. Investigations based on this method allow for finding out a spatial distribution of density of fluid in the closed tank. The accuracy of the results depends on the concentration of particles. This method can be useful as a supplement of measurements settling processes in drilling muds performed with other methods. In the case of highly concentrated drilling muds, this method seems problematic.

Still another method of measuring settling processes is the direct weight measurement method, which allows for simulating dynamic conditions and investigating the influence of temperature on the settling processes. With this method one can simulate the rotation of the string and analyze its influence on the settling. The schematic of the system is presented in (Fig. 3b). A sampling cup is suspended on a stiff string and attached to the laboratory sales where the solids collected in the cup are weighed. With the advancing settling process, the weight increases. The sampling cup is placed concentrically below the cylindrical settling chamber. The sampling cup is a place where only solids from the fluid in the settling chamber are collected. The outer rotating cylinder is used for simulating the rotation of the string. The measuring system is disposed in a water bath, thanks to which the settling process can be measured for a predefined temperature. The schematic of an exemplary measuring system is presented in Figure 4.

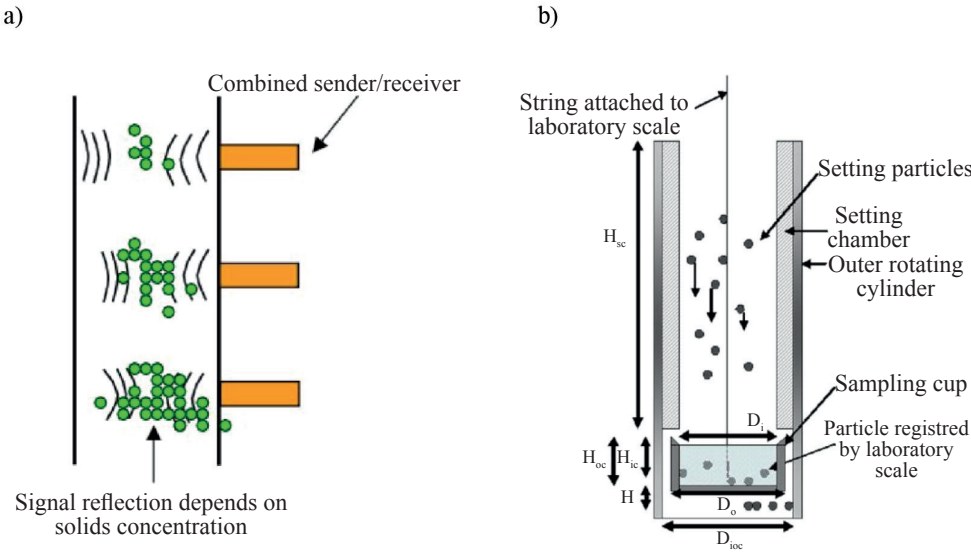
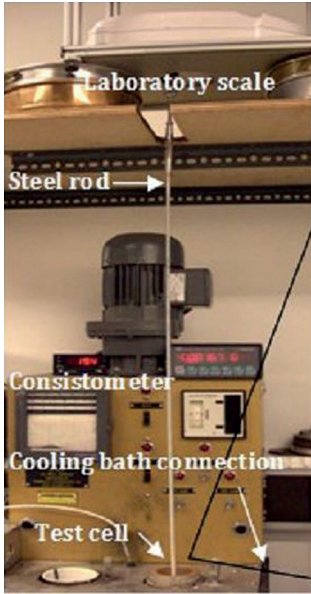

Fig. 3. The principle of ultrasonic measurement for sag determination. The amount of reflected energy is dependent on particle concentration. The technique can also be used to determine particle size distribution, flow regimes and displacement efficiency [4] (a); Direct weight measurement – equipment principle [4] (b)

a)



b)



Fig. 4. Measuring system used in direct weight measurement method:
a) measuring system; b) elements of measuring system: sampling cup
where settling solids are collected, settling chamber, and outer rotating cylinder [4]

Settling can be also measured with the Nuclear Magnetic Resonance (NMR). In this type of measurement the reaction of atomic nuclei on magnetic field is used. Most odd atomic nuclei have a non-zero magnetic moment. These moments are random, giving the resultant magnetization of a sample equal to zero. The external non-zero magnetic field B_0 results in the ordering of magnetic moments along the direction of the external magnetic field. This causes that the sample is magnetized. Under the influence of external magnetic field B_0 the precession of a vector describing the magnetic moment around the field B_0 takes place. This is visualized in Figure 5. The precession frequency is expressed with the formula (6):

$$\omega_0 = \gamma \cdot B_0 \quad (6)$$

where:

- ω_0 – Larmor frequency [Hz],
- γ – gyromagnetic coefficient [Hz/T],
- B_0 – external magnetic field [T].

There are possible two states: the direction of vector describing the nuclear magnetic moment is congruent or opposite to the direction of external magnetic field. Using a changing, pulsating magnetic field B_1 we evoke changes in the state of atomic nuclei. There are two impulses: 90° and 180° . In the first case the impulse changes the direction of the sample

magnetization vector by 90°, and in the other case by 180°. Field B_1 is a disturbing field. When it is switched off, the nuclei return to their initial state causing emission of a radio signal, which decayed exponentially and its relaxation time T_2 can be measured.

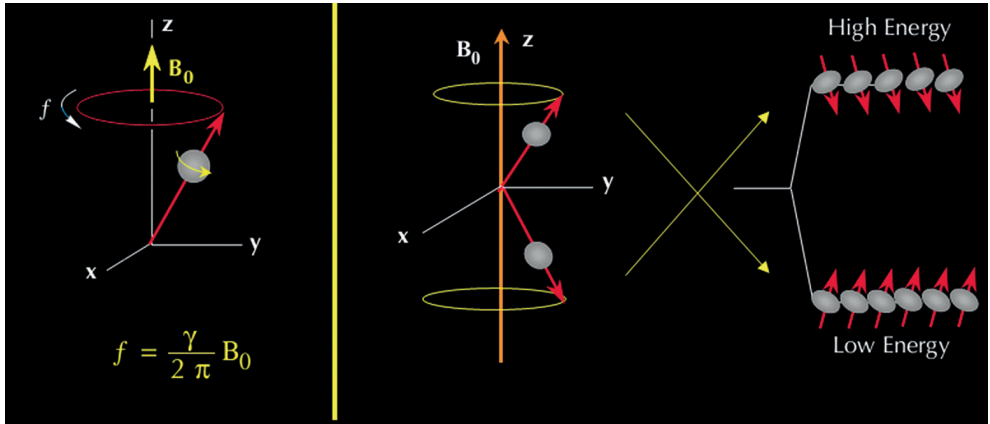

Fig. 5. Precession of nuclear magnetic moment around direction of external magnetic field B_0 [5]

The amplitude of the NMR signal from a sample depends on the concentration of atomic nuclei which react to the external magnetic field. Barite, which is frequently used as weighting material, has a lower concentration of such atoms than the surrounding fluid. By measuring changes of NMR signal amplitudes one can measure settling of drilling mud. Barite concentration also influences average time T_2 .

3. EXPERIMENTAL

Experiments [3] were performed on 4 drilling mud mixtures labeled as OBM1, and 4 mixtures labeled as OBM2. In both cases muds were based on oil. The mixtures differed in the weighting material content, i.e. 150, 250, 350 and 450 g, respectively. Drilling muds OBM1 and OBM2 differed in viscosity; in the case of OBM2 more agent increasing viscosity was used. The chemical composition of the applied mixtures is presented in Table 1.

Prior to the measurements on the analyzed muds, air bubbles were removed from them with the use of a vacuum chamber where the mud samples were disposed. Initially the dependence of shear stress τ [Pa] and shear rate $[s^{-1}]$ was investigated. For this reason the rheometer Physica UDS 200 by Anton Paar in concentric array Z3-C was applied. The measurements were performed at a temperature of 35°C and shear rates 0.1÷1200 s^{-1} . For each mixture 60 measuring points were obtained and various rheological models were adjusted to them. The Bingham model turned out to be the best described measurement data in all cases. The quality of fit was evaluated on the basis of the determined correlation coefficients R and the standard deviation σ . These parameters are described with equations (7) and (8), respectively. The obtained results are listed in Table 2.

$$R = \frac{\left| \sum_{i=1}^n (y_i - \hat{y}) \right|}{\sqrt{\sum_{i=1}^n (y_i - \hat{y})^2}} \quad (7)$$

$$\sigma = \sqrt{\frac{\sum_{i=1}^n (y_i - \hat{y})^2}{n}} \quad (8)$$

where:

y_i – measured value (i -th measuring point),

\hat{y} – expected value,

n – number of measurements.

Table 1

Chemical composition of analyzed mud mixtures (with name of the component, its function and content in grams) [3]

| Component | OBM1- -150 | OBM1- -250 | OBM1- -350 | OBM1- -450 | OBM2- -150 | OBM2- -250 | OBM2- -350 | OBM2- -450 |
|---|-------------------|---------------|---------------|---------------|---------------|---------------|---------------|---------------|
| EDC 95/11 (mineral oil) | 206 ml = 167.89 g | | | | | | | |
| Solution of CaCl ₂ (brine) | 60 ml = 68.4 g | | | | | | | |
| Paramul (emulsifier) | 3 ml = 2.87 g | | | | | | | |
| Parawet (emulsifier) | 9 ml = 8.02 g | | | | | | | |
| CaOH ₂ | 8.5 g | | | | | | | |
| Versa Vert Vis (agent increasing viscosity) | 0.5 g | | | | 5.0 g | | | |
| Versatrol (agent lowering viscosity) | 6.0 g | | | | | | | |
| Barite (weighting material) [g] | 150 | 250 | 350 | 450 | 150 | 250 | 350 | 450 |

Table 2

Determined Bingham rheological models for various mud mixtures [3]

| Mud mixture | Model | R | σ |
|-------------|---|--------|----------|
| OBM1-150 | $\tau = 0.0566 + 0.0214 \cdot \dot{\gamma}$ | 0.8782 | 2.9959 |
| OBM1-250 | $\tau = 0.3437 + 0.0300 \cdot \dot{\gamma}$ | 0.9283 | 2.8398 |
| OBM1-350 | $\tau = 1.2627 + 0.0468 \cdot \dot{\gamma}$ | 0.9657 | 2.6908 |
| OBM1-450 | $\tau = 1.4858 + 0.0647 \cdot \dot{\gamma}$ | 0.9721 | 2.9754 |
| OBM2-150 | $\tau = 1.7632 + 0.0440 \cdot \dot{\gamma}$ | 0.9647 | 2.5813 |
| OBM2-250 | $\tau = 2.1105 + 0.0552 \cdot \dot{\gamma}$ | 0.9748 | 2.6005 |
| OBM2-350 | $\tau = 2.7440 + 0.0705 \cdot \dot{\gamma}$ | 0.9792 | 2.8561 |
| OBM2-450 | $\tau = 3.5319 + 0.0929 \cdot \dot{\gamma}$ | 0.9796 | 3.5448 |

With the growing barite content in the analyzed muds, it is also the yield point and dynamic viscosity which increases. As expected, for the same amount of barite particles both parameters had higher values for OBM2 (where more agent increasing viscosity was added). The Bingham models best describe the measuring data only in global scale which is connected with the changing character of the analyzed fluids. For a shear rate under 800 s^{-1} they have properties of a pseudoplastic fluid. At high shear rates the apparent viscosity increases with the growing shear rate and fluid manifests its thickening by shearing (dilatation). For low shear rates the measuring data are best described by the Herschel–Bulkley model. The varying properties of drilling muds make the simulation of settling processes difficult.

After determining rheological models of analyzed muds, the settling processes were analyzed with the use of the direct weight method. Firstly, the measuring system was prepared. The settling cup was disposed inside the cylinder leaving a 2 to 4 mm gap. Moreover, the sampling cup was placed concentrically to avoid falling of the particles beyond the cup area. Prior to measuring, the measurement chamber was located in a water bath of 35°C . Next the mud was slowly poured out into the chamber to avoid new bubble formation (former have been already removed). Figures 6 and 7 illustrate the results of the measurements for mixtures OBM1 and OBM2. Considerable convergence of the obtained results was observed for the OBM1 muds (the measurement data form nearly smooth curves). Slight oscillations appear only after 10 hours, but even then the tendency is very distinct.

In the case of muds OBM2 the scatter of measuring data is huge. The differences between successive measuring points are bigger and they do not form smooth plots. Contrary to OBM1 muds, which had a strong incremental tendency, OBM2 muds have periods of drops and plateaus. Muds of OBM1 and OBM2 differ in the content of agents increasing viscosity. Presumably the rheology connected with the drilling mud composition significantly influences the quality of the obtained results. It was observed that the deterioration of the obtained results was associated with the increase in viscosity. Drilling industry makes use of fluids of higher rheological parameters than the analyzed muds. For this reason the applied method has to be modified when measurements are to be made on actual drilling muds used by industry.

Both in the case of OBM1 and OBM2 muds the solids settle down quickly in the initial period of the test. After some time the settling of OBM1 muds rapidly slows down till the moment one can consider the process is over. The observations correspond with predictions. In the initial period the biggest particles tend to settle first due to the gravity forces which act on them strongest. In a majority of cases some structure is formed in the idle-resting muds. It is formed only after some time causing that the forces counteracting settling processes will grow with time. The decrease in the number of settling particles after some time is also caused by the fact that the number of particles suspended in fluid decreases in the course of the settling processes. The fastest settling of the solid phase in OBM2 muds also takes place in the initial stage of measurement. Then the amount of settling particles decreases to the non-settling level. Opposite to OBM1 muds, there was registered a rapid increase of settling particles after 5 to 6 hours, which is visible in Figure 7. This may be the evidence of rapid structural changes in OBM2 muds, leading to avalanche settling. Operationally, this effect is very unfavorable as may lead to the rapid hydrostatic pressure exerted by the column of drilling mud, and consequently the flux of reservoir fluid to the wellbore. These observations do not refer to mud

OBM2-150, where a strong incremental tendency has been noted. However, despite the maintaining incremental tendency less solid phase had settled in this mud than in other OBM2 muds. It cannot be excluded that further in the measurement, these proportions could get reversed.

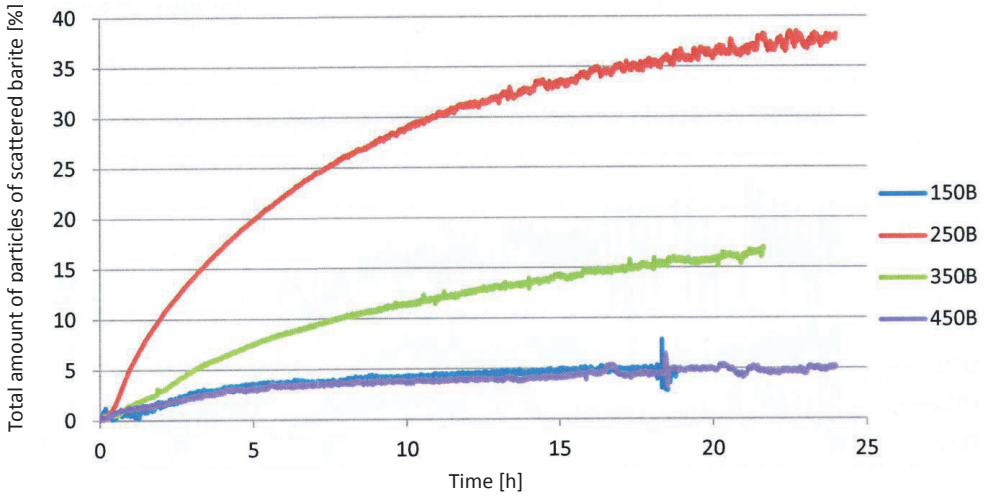

Fig. 6. Plot representing percentage of total amount of particles of scattered barite (weighting material) which falls down to the sampling cup in muds OBM1 in a function of time [3]

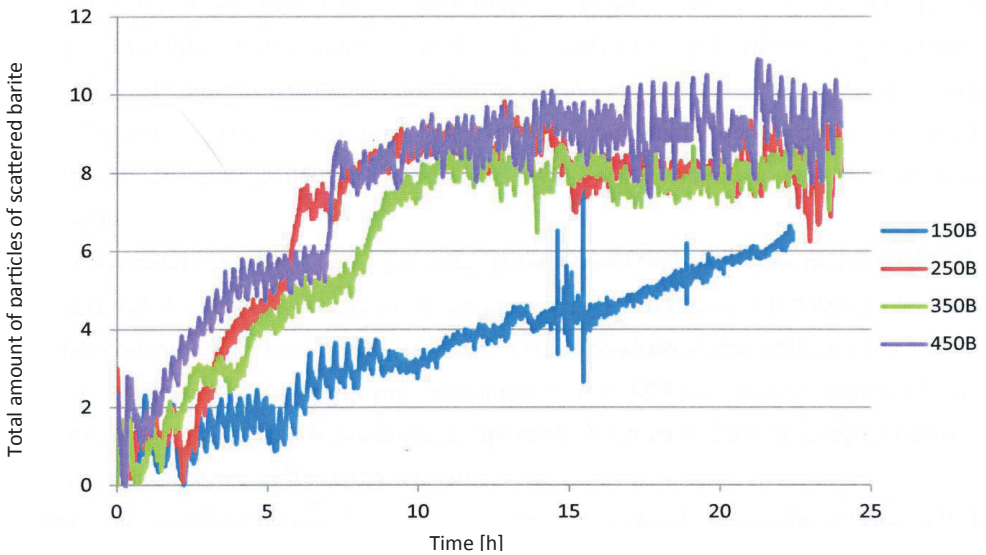

Fig. 7. Plot representing percentage of total amount of particles of scattered barite (weighting material) which falls down to the sampling cup in muds OBM2 in a function of time [3]

The analysis of plots in Figures 7 and 8 reveals that OBM1-50 and OBM1-450 muds are most resistant to settling as only 5% of the solid phase settled during the tests. In OBM2 muds the percentage of settled particles did not exceed 10%; among OBM1 muds there were mixtures for which this value was exceeded. As far as the resistance to settling goes, the OBM1 muds can be decreasingly ordered: OBM1-150, OBM1-450, OBM1-350, OBM1-250. Analogously for OBM2 muds we have: OBM2-150, OBM2-350, OBM2-250, OBM2-450. Measured parameters characterizing analyzed muds and the effect of barite settling are presented in Table 3.

Table 3

Parameters characterizing analyzed muds and settling of barite particles [3]

| Mud mixture | Total mass of solids [g] | Mass of settled material [g] | Percentage of settled solid material |
|-------------|-----------------------------|---------------------------------|---|
| OBM1-150 | 159.32 | 8.042 | 5.05 |
| OBM1-250 | 245.12 | 93.674 | 38.22 |
| OBM1-350 | 321.7 | 54.659 | 16.99 |
| OBM1-450 | 389.28 | 19.977 | 5.13 |
| OBM2-150 | 159.32 | 10.575 | 6.64 |
| OBM2-250 | 245.12 | 23.3 | 9.51 |
| OBM2-350 | 321.7 | 28.476 | 8.85 |
| OBM2-450 | 389.28 | 40.38 | 10.37 |

4. CONCLUSIONS

Settling taking place in a drilling mud in a wellbore creates a problem. The advancing process may lead to various drilling complications. Problems usually appear when mud circulation is temporarily stopped for technological reasons. However, settling may also take place in dynamic conditions with the on-going mud circulation. This is especially important in directional wells, where for certain well angles the risk of settling is higher, when the gathering solids may slide down and bury the bit. This problem is important to the drilling industry as the cost of fixing break-downs and drilling complications due to settling processes taking place in mud are really high. For this reason numerous research works and investigations addressing this issue have been conducted all over the world. Selected methods of investigating the settling processes in a drilling mud were described in this paper. Measuring methods to be used in static and dynamic conditions were presented. There were also discussed the results of measurements of 8 mud mixtures for which rheological models were selected. The settling of barite particles in these muds was analyzed with the use of direct weighting method. The measurements indicated a strong influence of methodological rheological parameters on the quality of the obtained results. The muds used by industry have higher rheological parameters than the analyzed muds, therefore this method should be preferably modified to open measurement possibilities also to such fluids. Muds OBM1-150 and OBM1-450 appeared to be most resistant to settling as they contained lower quantities

of viscosity enhancing agent than OBM2 muds. During measurement the OBM2 muds probably underwent some changes in their structure. As a result, after 5 to 6 hours of measurement, a rapid change in the amount of settled particles was observed. Attention should be paid to such phenomena as in the wellbore conditions they may lead to avalanche settling, a considerable change of hydrostatic pressure of the column of drilling mud and potentially flux of reservoir fluid to the wellbore. Bearing in mind the gravity of the problem, the new recipes of drilling mud are tested in mud laboratories with the use of presented (and other) methods. Further growth of interest in this subject matter is expected, especially the development of simulation methods, which due to the complex rheology, are still far from perfect.

REFERENCES

- [1] Amoco: *Drilling Fluids Manual*. 2002
- [2] Bielewicz D.: *Fluyny wiertnicze*. Wydawnictwa AGH, Kraków 2009.
- [3] Wróblewski T.: *Analysis of barite settling in oil-based drilling fluids*. AGH University of Science and Technology, Krakow 2012 [M.Sc. thesis].
- [4] Omland T.H.: *Particle Settling in non-Newtonian Drilling Fluids*. University of Stavanger, 2009 [Ph.D. thesis].
- [5] Coates G., Xiao L., Prammer M.: *NMR Logging Principles & Applications*. Halliburton Energy Services, Houston 1999.