

STANISŁAW CIERPISZ*[#], JAROSŁAW JOOSTBERENS****IMPACT OF FEED CONTROL ON THE COAL BED STABILITY IN A JIG****WPLYW REGULACJI NADAWY NA STABILNOŚĆ ŁOŻA WZBOGACANEGO WĘGLA W OSADZARCE**

The paper presents a simulation analysis of four control systems of the raw coal feed to a jig: stabilization of the volumetric flow of the feed, stabilization of the feed tonnage, stabilization of the feed flow with the additional measurement of the feed bulk density or the additional measurement of ash content in the feed. Analysis has been performed for the first and second compartments of a jig. The aim of the feed control was to stabilize the mass of the bed in the zone where the material stratifies; the mass may change due to changes in the washability characteristics of the feed. Such control should result in stable conditions in which material loosens during subsequent media pulsation cycles; stabilizing conditions minimizes the dispersion of coal particles in the bed. The best results have been achieved for the system of feed control where the ash content was measured in the first compartment, and for feed tonnage control in the second compartment.

Keywords: Coal separation, jig control, feed control, bed stabilization

Przedstawiono symulacyjną analizę czterech układów stabilizacji nadawy węgla surowego do osadzarki: stabilizację przepływu objętościowego nadawy, natężenia przepływu masowego, przepływu z dodatkowym pomiarem gęstości nasypowej oraz z pomiarem zawartości popiołu w nadawie. Analizę przeprowadzono dla pierwszego i drugiego przedziału osadzarki. Celem układów regulacji nadawy była stabilizacja masy materiału w strefie rozdziału osadzarki, która może zmieniać się na skutek zmian charakterystyki wzbogacalności węgla surowego. Układy stabilizacji nadawy powinny stabilizować warunki rozluźniania węgla w kolejnych cyklach pulsacji minimalizując rozproszenie ziaren węgla w łożu osadzarki. Najlepsze wyniki uzyskano dla układu stabilizacji nadawy z pomiarem zawartości popiołu (dla pierwszego przedziału osadzarki) oraz dla układu stabilizacji przepływu masowego dla drugiego przedziału osadzarki.

Słowa kluczowe: wzbogacanie węgla, sterowanie osadzarki, regulacja nadawy, stabilizacja łoża

* SILESIA UNIVERSITY OF TECHNOLOGY, 2 AKADEMICKA, 44-100 GLIWICE, POLAND

** SILESIA UNIVERSITY OF TECHNOLOGY, DEPARTMENT OF ELECTRICAL ENGINEERING AND AUTOMATION IN INDUSTRY, 2 AKADEMICKA, 44-100 GLIWICE, POLAND

Corresponding author: el.st.cierpisz@gmail.com

1. Introduction

Raw coal is a mixture of particles with varied content of mineral matter (ash content) determining the calorific value of the particle. The high quality product should consist of particles from the lowest up to the highest elementary ash content (called the “separation elementary ash”); the mean ash content is a weighted mean of all particles reporting to this product. Particles in which the ash content exceeds the value of the “separation elementary ash” report to refuse. In practice, the correlation between the ash content and the density of particles is used so, instead of the “separation ash”, we monitor the “separation density” to control a coal beneficiation process on-line.

Raw coal is often beneficiated in the gravitational processes where coal particles are stratified according to their densities in a pulsating water/coal medium in jigs (Fig. 1). They have been discussed by Lyman (2001), Diendonno et al. (2006) and Cierpisz (2012).

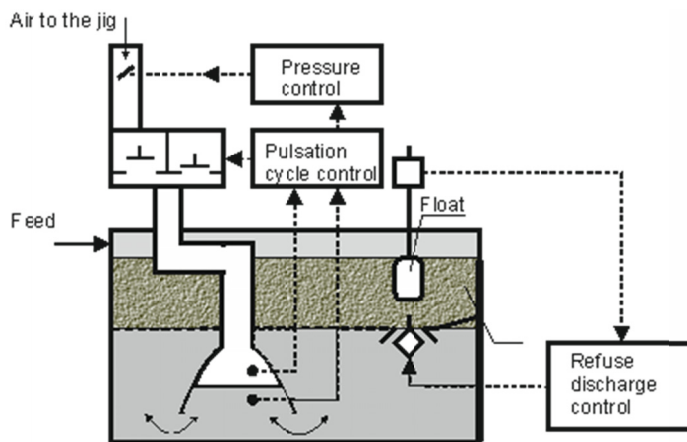

Fig. 1. Block scheme of the control of a pulsation cycle and refuse discharge

During the subsequent water pulsations induced by opening and closing of air valves, coal stratification occurs as particles begin to move upwards and downwards with varied velocity. Particles of low density migrate to upper material layers and particles of high density migrate to lower layers. The material is transported horizontally on the screen along the jig compartment with the flow of water. The stratification of coal particles due to their density is not ideal because the velocity of their upward and downward movement also depends on their diameters, shape and variations in the process of material loosening during the pulsation cycle. Stratified material is separated according to a chosen separation density, which is the density of a layer reporting in half to the upper product (concentrate) and in half to the discharged lower product (refuse). Refuse is removed through the discharge gate and concentrate overflows the splitting gate. The quality of product depends on the density of the separation layer.

Each compartment of a jig can be divided into three zones: the feed zone, the stratification zone and the product discharge zone (Fig. 2).

The stratification of raw material to produce concentrate, middlings and refuse takes place in the stratification zone as a result of pulsation of water/coal media. Fig. 3 shows how those

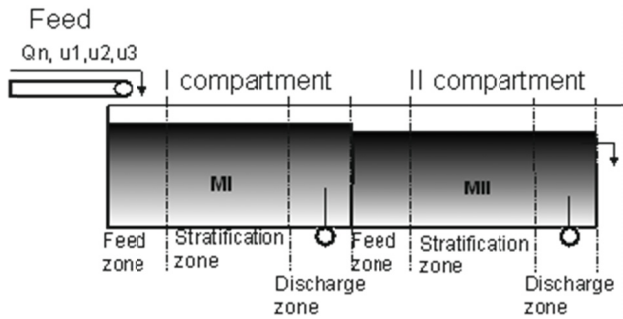

Fig. 2. Zones of the feed, stratification and product discharge in a jig

layers form in the stratification zone. Washability characteristics of the feed is represented by the yield of density fractions of raw coal in the feed $w(\rho)$. The dispersion of particles in the individual layers is defined by partition coefficients of the partition curve $f(\rho)$. Density layers travel horizontally with volumetric flows q_i and various velocities v_i , from the highest, at the top of the bed to the lowest, at the bottom of the bed. Varied velocities result in a highly nonlinear distribution of thickness h_i .

Effectiveness of a coal separation process depends on the dispersion of particles of varied density in the individual layers; the dispersion can be minimized when the material is properly

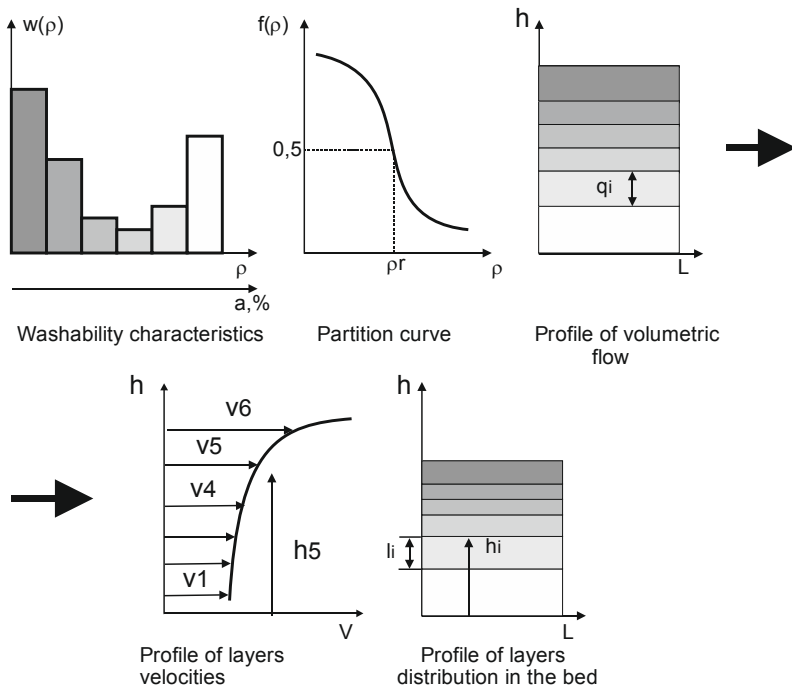

Fig. 3. Density layers forming in the bed

loosened during subsequent pulsations (Xia et al., 2007; Srinivasan et al., 1999). The process is hampered by changes in tonnage and washability characteristics of the feed which can be quite significant. One of the important conditions for stable material loosening is stable mass of material MI and MII in stratification zones in the first and second compartment (Fig. 2). This should be accomplished by feed control systems applied in industrial installations. In practice, four types of feed control systems are applied: stabilization of (1) volumetric or (2) mass flow of material to a jig with additional measurement of (3) bulk density of the feed or (4) ash content in the feed. Each of these control systems has a different reaction to changes in the feed and produces different fluctuations in the mass in stratification zones.

The aim of this paper is to compare the operation of the control systems against feed disturbances and to analyze effects of control. Such analysis is not available in open literature. The fluctuations in the mass of material in the stratification zone depend on changes in tonnage and quality of the feed and different velocities of density layers in the bed discussed in further sections of the paper.

2. Changes in parameters of the feed to a jig

The feed to a jig is mainly raw coal fines 20(30)–0.5(0) mm size usually transported from a bunker. Raw fines are often transported to a jig without screening, sometimes 3–0 (6–0) mm size is screened out from the feed. The effectiveness of coal beneficiation in a jig highly depends

2.1. Changes in the feed tonnage to a jig

Technological systems of coal preparation in jigs usually apply bunkers designed to stabilize the feed flow to a jig sensitive to variations in the load. In practice, however, despite the bunkers, significant fluctuations in the feed tonnage can appear; they are caused by breakdowns in coal transportation or disturbances in the coal flow from the bunker outlet due to changing size distribution or moisture content in raw fines. An example of such changes in the feed tonnage is presented in Figs. 4 and 5 (Cierpisz, 2012). Fig. 4 shows changes in the feed (average for 5 min.) over a period of 5 hours. The mean value was 343 t/h and the standard deviation was 105 t/h.

Changes in the feed tonnage change the bed height and alter the density profile of the material in the stratification zone.

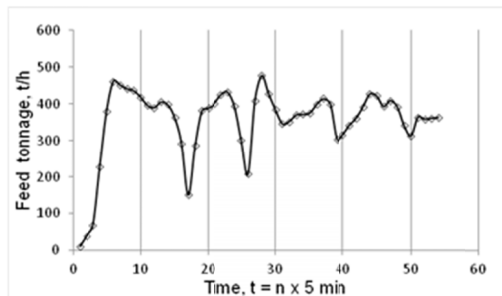

Fig. 4. An example of variations of the feed flow to a jig

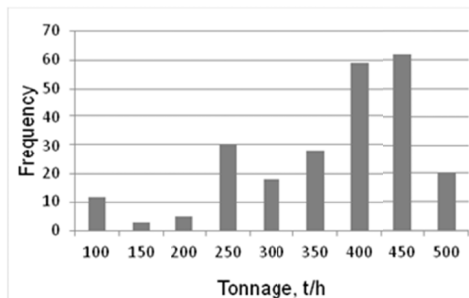

Fig. 5. A distribution of the feed flow

2.2. Changes in the ash content in the feed

Important coal quality parameters include ash content, which can be measured on-line by radiometric ash monitors. Ash content in raw coal depends mostly on amount of the concentrate (fraction of density $<1.5 \text{ g/cm}^3$) and on amount of refuse (fraction of density $>1.8 \text{ g/cm}^3$). Significant increase in ash content usually signals overload of refuse discharge system in a jig and worsening degree of bed loosening. Low ash content may mean small amounts of refuse, excessive degree of material loosening and an increase in imperfections in the jig. Fig. 6 shows an example of how ash content changes with time in the feed to a jig (Kowol, 2011) and Fig. 7 shows the distribution of ash content measurements.

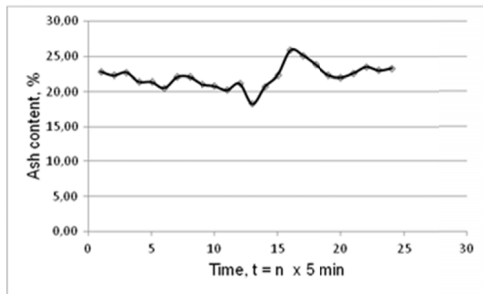

Fig. 6. An example of ash content variations in a jig feed

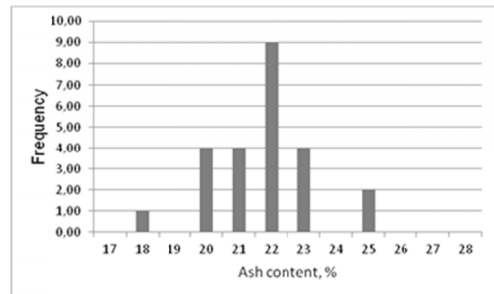

Fig. 7. A distribution of ash content

The mean value of ash content was $M_A = 22.2\%$ and the standard deviation was $\sigma_A = 1.8\%$. Table 1 presents the results of long term experiments on ash content fluctuations over the period of 4 months.

TABLE 1

Parameters of ash content changes in raw fines			
Experiment	Mean ash;%	Stand.dev.%	α ; 1/min
1	23.3	1.3	0.057
2	23.7	1.8	0.033
3	21.9	1.2	0.080
4	27.3	2.1	0,050

Each time-series of ash content have been approximated by a stationary process with the autocorrelation function $R(\tau) = \sigma^2 \exp(-\alpha|\tau|)$. For a long period of time the process appears to be a non-stationary process with the mean value varying between 21.9% and 27.3%, the standard deviation σ in the range of 1.2-2.1% and the decay coefficient α between 0.025 1/min and 0.080 1/min.

2.3. Washability characteristics

Washability characteristics of raw coal, defined by yields of density/ash fractions in the feed, is determined in time- and labour-consuming laboratory analysis of coal samples in heavy media tests. For these reasons, to estimate performance of the separation process, the detailed washability characteristics for 8-10 density fractions is periodically determined. In practice, the tests of raw coal feed to a jig are limited to heavy media routine tests performed once or twice a shift for three density fractions, typically $<1.5 \text{ g/cm}^3$, $1.5\text{-}1.8 \text{ g/cm}^3$, $>1.8 \text{ g/cm}^3$. The yield and ash content in these fractions is usually determined. Similar information can be gathered from belt weighers and ash monitors installed on belt conveyors transporting concentrates, middlings and refuse, but such installations are not always used in coal preparation plants. Fig. 8a-c shows an example of distribution of these three density fractions in the feed in one of the mines (Kowol, 2011).

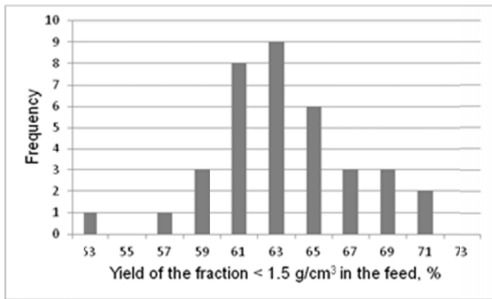

Fig. 8a. Yield of the density fraction $<1.5 \text{ g/cm}^3$

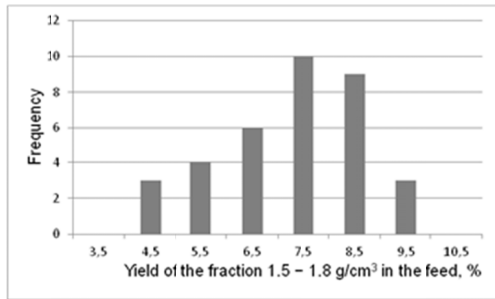

Fig. 8b. Yield of density fraction $1.5\text{-}1.8 \text{ g/cm}^3$

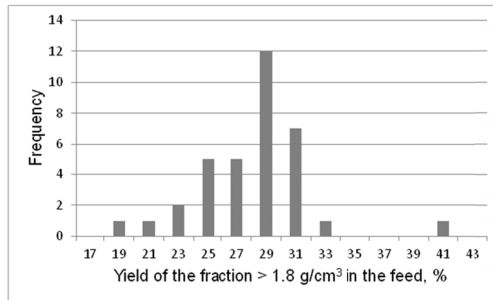

Fig. 8c. Yield of the density fraction $>1.8 \text{ g/cm}^3$

Table 2 presents examples of mean values and standard deviations for the three density fractions in three mines (Cierpisz, 2012; Kowol, 2011), monitored for a period of 4 months.

3. Horizontal transportation of material in a jig

Stratified coal particles form density layers which travel with various horizontal velocities towards the discharge zone. Fig. 9 shows the relation between particle density and particle veloc-

TABLE 2

Yields of density fractions in the feed to a jig					
Mine	Fraction	Yield of density fraction in the feed, %			
Mine 1	u_1	63.6	53	71	3.6
	u_2	8.3	4.5	9.5	1.5
	u_3	28.1	19	41	3.6
Mine 2	u_1	33.7	24.2	47.5	5.6
	u_2	10.6	5.9	12.9	0.9
	u_3	55.7	41.8	65.2	5.1
Mine 3	u_1	55.8	49.2	62.3	3.0
	u_2	8.8	4.5	13.5	2.1
	u_3	35.4	32.1	38.7	1.4

u_1 – fraction $<1.5 \text{ g/cm}^3$, u_2 – fraction $1.5\text{-}1.8\text{g/cm}^3$, u_3 – fraction $>1.8 \text{ g/cm}^3$

ity in a jig, as reported by Lyman (source: Coal Preparation in South Africa. The South African Coal Processing Society, 4th edition, 2002).

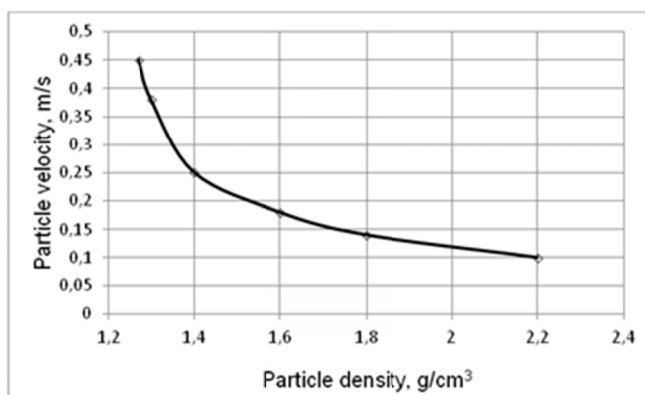

Fig. 9. Velocity of a particle as a function of a particle density

The stratification of particles in the bed has been investigated by King (2001) and recently Woollacott et al. (2015). King (2001) formulated a relation between the velocity v of particles and the position of the density layer h :

$$v(h) = k \cdot h - (1-k) \cdot h^2 \quad (1)$$

where: k – coefficient

Results of experiments performed by Kowol (2011) were used to estimate velocities for the selected density layers in a jig. The positions of layers were measured by three floats of specific densities. The first float (1.2 g/cm^3) measured the height of the whole bed, the second measured the position of the concentrate layer (1.5 g/cm^3) and the third the position of the middlings layer (1.75 g/cm^3). Experiments were performed in the technological system presented in Fig. 10.

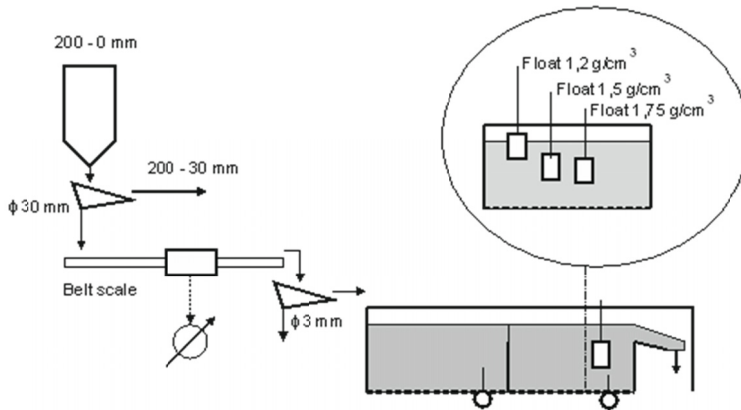

Fig. 10. Technological system (Kowol, 2011)

The results of measurements are shown in Fig. 11.

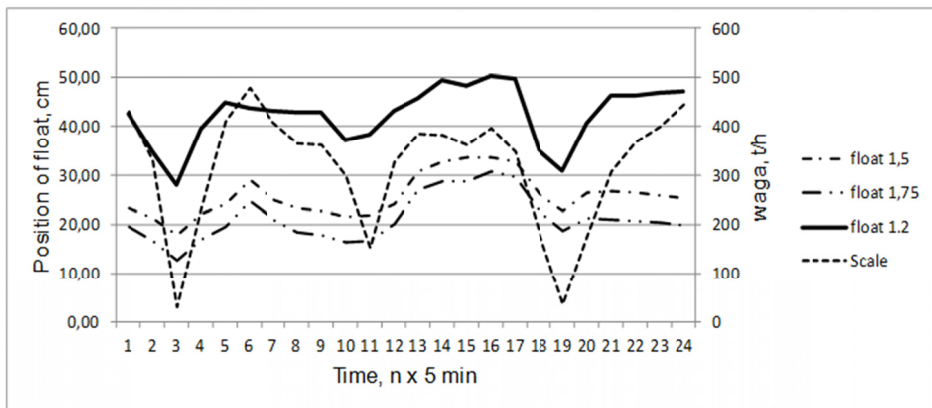

Fig. 11. Position of density layers in the jig's bed and changes in tonnage of the feed

Average thickness of layers based on float positions and indications of the belt scale during the experiment were as follows:

$Q_n = 316 \text{ Mg/h}$, layer (1) $< 1.5 \text{ g/cm}^3 - h_1 = 16.7 \text{ cm}$;

layer (2) $1.5\text{-}1.8 \text{ g/cm}^3 - h_2 = 4.5 \text{ cm}$;

layer (3) $> 1.8 \text{ g/cm}^3 - h_3 = 17 \text{ cm}$.

The parameters of the feed and the jig were as follows (Table 2, Mine 1):

- a) bulk density of the feed – 0.8 g/cm^3 (for the mean density of 1.5 g/cm^3);
- b) yield of density layers: – $u_1 = 63.6 \%$; $u_2 = 8.3 \%$; $u_3 = 28.1 \%$;
- c) mean densities of fractions: – $\rho_1 = 1.35 \text{ g/cm}^3$; $\rho_2 = 1.65 \text{ g/cm}^3$; $\rho_3 = 2.2 \text{ g/cm}^3$;
- d) width of the jig compartment: – $b = 3.0 \text{ m}$.

Mean velocities for two layers (1) and (2) can be calculated from equations (2) and (3):

$$v_1 = \frac{u_1 \cdot Q_n}{\rho_{n1} \cdot b \cdot h_1} = 0.15 \text{ m/s} \quad (2)$$

where: ρ_{n1} – bulk density of the fraction $<1.5 \text{ g/cm}^3$, ($\rho_{n1} = 0.72 \text{ g/cm}^3$),

$$v_2 = \frac{u_2 \cdot Q_n}{\rho_{n2} \cdot b \cdot h_2} = 0.061 \text{ m/s} \quad (3)$$

where: ρ_{n2} – bulk density of the fraction $1.5\text{-}1,8 \text{ g/cm}^3$, ($\rho_{n1} = 0.88 \text{ g/cm}^3$).

These velocities are much lower than those from the graph in Fig. 9. This is probably due to different parameters of jigs and the feed to jigs. The velocity of the third layer ($>1.8 \text{ g/cm}^3$) cannot be calculated from Fig. 11 as the majority of this fraction (unknown) is discharged in the first compartment. Interesting results of experiments were reported by Ciok et al. (1978) who applied radioactive tracers to measure the time particles take to travel in a jig. Velocities measured in this experiment for different particle sizes ranged respectively for concentrate: 0.1-0.3 m/s; middlings: 0.03-0.044 m/s; refuse: 0.02-0.03 m/s.

4. Control of the feed to a jig

This chapter discusses the results of a simulation analysis on the impact of feed control on conditions of a coal separation process in a jig using Matlab/Simulink software. The analyzed technological system consists of a bunker, belt conveyor with controlled belt speed or a vibrating feeder and a jig (Fig. 12).

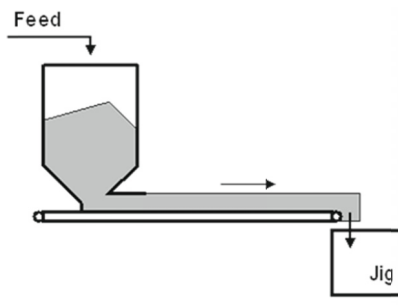

Fig. 12. Technological system of a bunker and a jig

The aim of the control system is to stabilize the mass of material in the stratification zone of the first compartment *MI* and in the second compartment *III*. To simplify the analysis let us disregard the interaction between the discharge zone and the stratification zone which influences the movement of stratified material. The following changes in the feed were accepted for the simulation purposes (Table 2, Mine 1):

- a) volumetric flow of the feed: $V_n = 395 \text{ m}^3/\text{h} \pm 15\%$ ($335 \text{ m}^3/\text{h}\text{-}455 \text{ m}^3/\text{h}$);

- b) tonnage of the feed: $Q_n = 316 \text{ t/h} \pm 15\%$ (270 t/h-363 t/h);
 c) yield of density fractions: $u_1 = 63.6\% \pm 3.6\%$ (of the feed); $u_2 = 8.3\% \pm 1.5\%$;
 $u_3 = 28.1\% \pm 3.6\%$ (Table 2, Mine 1);
 d) mean bulk densities of the feed fractions: $\rho_{n1} = 0.72 \text{ g/cm}^3$; $\rho_{n2} = 0.88 \text{ g/cm}^3$;
 $\rho_{n3} = 1.17 \text{ g/cm}^3$;
 e) mean densities of the feed fractions: $\rho_1 = 1.35 \text{ g/cm}^3$; $\rho_2 = 1.5 \text{ g/cm}^3$; $\rho_3 = 2.2 \text{ g/cm}^3$;
 f) mean velocities of density fractions in the bed: $v_1 = 0.2 \text{ m/s}$; $v_2 = 0.1 \text{ m/s}$; $v_3 = 0.03 \text{ m/s}$.

The mass of the stratified material in the stratification zone (length $l = 1 \text{ m}$) in the first compartment can be calculated, for an ideal separation process, as the sum of masses of three fractions with yields u_1, u_2, u_3 .

$$MI = M_1 + M_2 + M_3 \quad (4)$$

$$M_i = b \cdot l \cdot h_i \cdot \rho_{ni} \quad (5)$$

where: ρ_{ni} – bulk density of layers in the bed.

The thickness of the layer h_i is calculated from equation (2):

$$h_i = \frac{u_i \cdot Q_n}{\rho_{ni} \cdot b \cdot v_i} \quad (6)$$

$$M_i = u_i \cdot l \cdot \frac{Q_n}{v_i} = V_n \cdot \rho_n \cdot u_i \cdot l \cdot \frac{1}{v_i} \quad (7)$$

where:

$$\rho_n = 1 / \left(\frac{u_1}{\rho_{n1}} + \frac{u_2}{\rho_{n2}} + \frac{u_3}{\rho_{n3}} \right) \text{ is the bulk density of the feed} \quad (7a)$$

and

$$MI = V_n \cdot \rho_n \cdot l \cdot \left(\frac{u_1}{v_1} + \frac{u_2}{v_2} + \frac{u_3}{v_3} \right) \quad (8)$$

Assuming that the whole fraction $>1.8 \text{ g/cm}^3$ is discharged as a refuse in the first compartment, the mass III in the second compartment can be calculated from equation (8) for $u_3 = 0$:

$$III = V_n \cdot \rho_n \cdot l \cdot \left(\frac{u_1}{v_1} + \frac{u_2}{v_2} \right) \quad (9)$$

Mass of the material in stratification zones has been calculated for maximal changes in density fractions in the feed equal to two standard deviations 2σ (MIa and $MI Ib$):

a) $u_3 = 0.351$; $u_2 = 0.053$; $u_1 = 1 - (u_2 + u_3) = 0.596$

b) $u_3 = 0.211$; $u_2 = 0.113$; $u_1 = 1 - (u_2 + u_3) = 0.676$

$MIa = 1.19 \text{ t}$, $MI Ib = 0.86 \text{ t}$

$IIIa = 0.596 \text{ t}$, $IIIb = 0.336 \text{ t}$.

The relative change in the mass in stratification zones can be defined by relation (10):

$$\delta = \frac{M_a - M_b}{M_a} \cdot 100 \% \quad (10)$$

$$\delta I = 38.4\%, \delta II = 77.4\%$$

4.1. Control of the volumetric flow of the feed

The control system of the volumetric flow of the feed to the jig is shown in Fig. 13. The control system consists of a volume (surface contour) meter installed above the belt and a belt speed meter to calculate the volumetric flow (m^3/h) of the feed to a jig. The signal from the meter is compared with the desired value of the volumetric flow $V_{n(des)}$ and sent to the controller adjusting the speed of the belt or amplitude of the vibro feeder. The mass of material MI in the first compartment and MII in the second compartment can be calculated from equations (8) and (9) for $V_n = V_{n(des)}$. For the same disturbances in yields of density fractions in the feed (no control) we obtain:

$$\begin{aligned} MIa &= 1.41 \text{ t}; MIIb = 1.02 \text{ t}, \\ MIIa &= 0.397 \text{ t}; MIIb = 0.3 \text{ t}, \\ \delta I &= 38.2 \%; \delta II = 22.5 \%. \end{aligned}$$

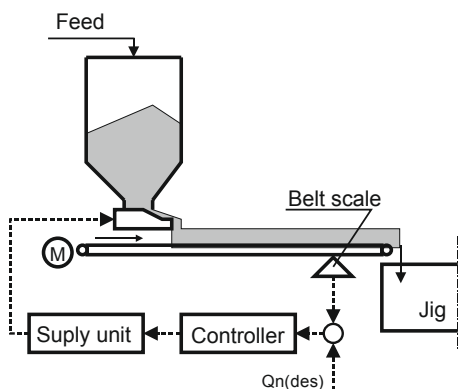

Fig. 13. System of the volumetric flow stabilization to a jig

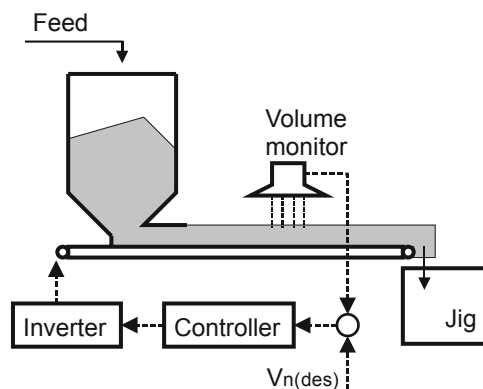

Fig. 14. System of the feed tonnage control

4.2. Control of the feed tonnage

Control system of the feed tonnage to a jig is shown in Fig. 14.

The control system consists of a belt scale, a controller and a controlled vibro feeder/inverter. The mass of material in stratification zones in the first and second compartments can be determined from equations (8) and (9) for $Q_n = V_n \cdot r_n = \text{const}$ ($Q_n = 316 \text{ t/h}$):

$$\begin{aligned} MIa &= 1.335 \text{ t}; MIIb = 1.1 \text{ t}, \\ MIIa &= 0.396 \text{ t}; MIIb = 0.308 \text{ t}, \\ \delta I &= 21.4\%; \delta II = 28.6\%. \end{aligned}$$

4.3. Control system with the measurement of bulk density

The control system with the measurement of bulk density of the feed is shown in Fig. 15. The bulk density of the feed is calculated from indications of the volumetric flow meter and the belt scale: $\rho_{n(calc)} = Q_n/V_n$. On this basis, yields of density fractions u_1 and u_3 can be estimated from equation (7a) if we accept constant yield of middlings $u_2 = u_{2(mean)}$. Then the required tonnage Q_n to ensure the desired mass of material MI can be calculated from equation (8):

$$Q_n = \frac{MI_{des}}{B_{calc}} \cdot l \quad (11)$$

where:

$$B_{calc} = \frac{u_1}{v_1} + \frac{u_{2(mean)}}{v_2} + \frac{u_3}{v_3} \quad (12)$$

The mass MI in the separation zone of the first compartment can be calculated now from equation (8):

$$MI = \frac{MI_{des} \cdot \rho_n \cdot B}{\rho_{n(calc)} \cdot B_{calc}} \quad (13)$$

where:

$$B = \frac{u_1}{v_1} + \frac{u_2}{v_2} + \frac{u_3}{v_3} \quad (14)$$

The bulk density $\rho_{n(calc)}$ is measured with the accuracy determined by errors in both meters which may range up to 2% (0.02 g/cm^3), therefore $\rho_{n(calc)} = \rho_n \pm 0.02 \text{ g/cm}^3$. For the above data we obtain the following changes in mass MI and MIl :

$$MIa = 0.968 \text{ t}; MIb = 1.053 \text{ t},$$

$$MIla = 0.221 \text{ t}; MIlb = 0.411 \text{ t},$$

$$\delta I = 8.8\%; \delta II = 87.3\%.$$

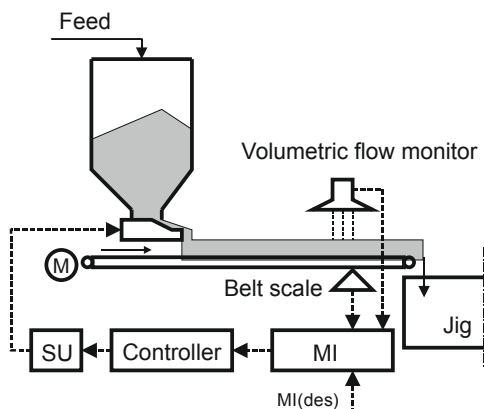

Fig. 15. Control system with the measurement of bulk density

A volumetric flow meter in Fig. 15 can be replaced by a radiometric ash monitor often used to monitor quality of the feed. The signal from this meter can be used in a way similar to the function of the volumetric flow meter and calibrated in raw coal density units. In this case the accuracy of the measurement is better and can be estimated in the range of $\pm 1\%$ (ca. 0.01 g/cm^3). Within this system, changes in mass MI and MII are the following:

$$\begin{aligned} MIIa &= 0.969 \text{ t}; MIIb = 1.01 \text{ t}, \\ MIIa &= 0.224 \text{ t}; MIIb = 0.406 \text{ t}, \\ \delta I &= 4.2\%; \delta II = 81.2\%. \end{aligned}$$

Table 3 summarises the effects of stabilization for three different washability characteristics defined in Table 2.

TABLE 3

Stabilization	Maximum relative change in the mass of material in compartments I and II δ , %					
	Mass	No control	V_n	Q_n	Bulk density	Ash content
Mine 1	MI	88.2	45.0	36.0	7.6	6.0
	MII	48.3	17.2	22.6	63.0	62.9
Mine 2	MI	81.3	49.7	32.5	5.0	2.6
	MII	63.6	35.3	35.3	95.3	95.3
Mine 3	MI	41.7	18.3	14.9	7.6	6.9
	MII	46.4	25.0	15.9	26.5	29.1

Fig. 16 shows changes in the mass of material in the first compartment for Mine 1 (Table 2). The simulated disturbances as functions of time were:

$$\begin{aligned} u_3 &= 0,281 + 0,07 \sin(1,5t), \\ u_2 &= 0,083 - 0,03 \sin(1t), \\ u_1 &= 1 - u_2 - u_3, \\ V_n &= 395 + 60 \sin(2t). \end{aligned}$$

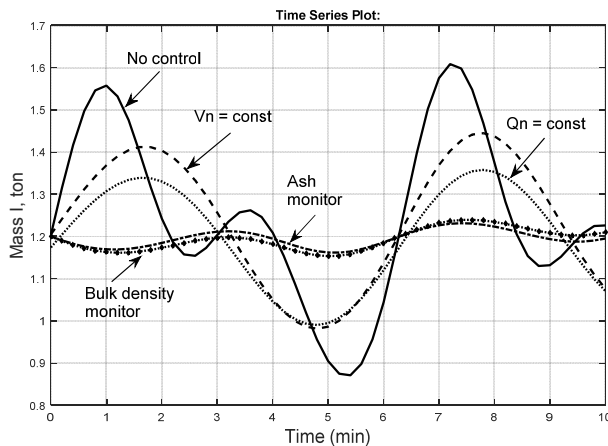

Fig. 16. Changes in the material mass in the bed (I compartment) produced by changes in the feed parameters and errors of measurement

Error of measurement for the bulk density as a function of time was simulated by:
 $\Delta\rho_n(t) = 0,01 \sin(0,5t)$ for volumetric flow meter,
 $\Delta\rho_a(t) = 0,005 \sin(0,5t)$ = for radiometric ash monitor.

Fig. 17 shows changes in the mass of material in the second compartment of a jig.

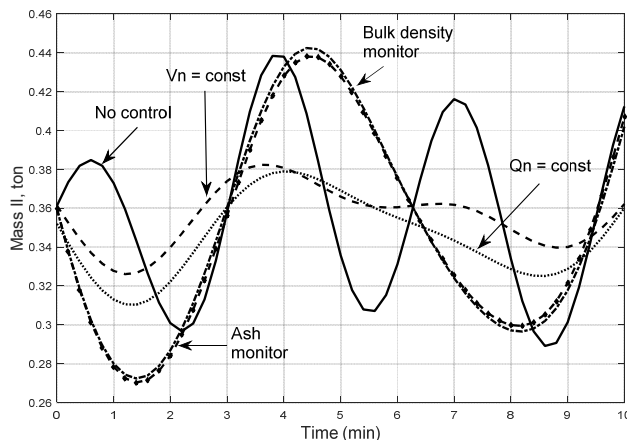

Fig. 17. Changes in the material mass in the bed (II compartment) produced by changes in the feed parameters and errors of measurement

5. Conclusions

Control systems of the feed to a jig aim to stabilize conditions of material stratification in compartments according to particle density. Mostly they achieve that by stabilizing the mass M of material in stratification zones. The main sources of disturbance in control systems are the tonnage of the feed and its density composition (washability). The impact of variations in the density composition is augmented by different horizontal velocities of the individual density layers in the bed from 0.2(0.3) m/s for the upper layers (concentrate) to 0.02(0.03) m/s for the bottom layers. That is why variations in refuse have a greater impact in the first compartment, while variations in concentrate influence the process in the second (third) compartment. Variations in the feed tonnage affect all compartments to roughly the same degree; for this reason stabilizing the volumetric flow or tonnage of the feed limits variations in mass M in both compartments. M changes in the first compartment can be further significantly decreased by controlling the tonnage of the feed as a function of its bulk density (or density) measured by a volumetric flow meter and a belt scale or a radiometric ash monitor. Unfortunately, this method simultaneously leads to significant increase of M variations in the second (third) compartment. The results of control for four control systems, when compared, show the advantage of tonnage control as it decreases M variations in both compartments to ca. 15-35%. Therefore, to select the optimal type of feed control for a given situation, first we need to analyse the type of feed disturbances and the type of a jig.

Acknowledgements

The authors would like to thank Faculty of Mining, Safety Engineering and Industrial Automation for providing financial support under the statutory research no. BK 268/RG1/2019.

References

- Cierpisz S., 2012. *Control of coal separation process in jigs*. Silesian University of Technology, Monography 403, Gliwice (in Polish).
- Ciok K. et al., 1978. *Investigations of the material flow in a jig using radioactive tracers*. Mechanization and Automation in Mining 3 (in Polish).
- Coal Preparation in South Africa. The South African Coal Processing Society, 4th edition, 2002.
- Diendonne V., Jonkers A., Loveday G., 2006. *An approach to confidently predicting jigging performance*. The Journal of the South African Institute of Mining and Metallurgy 106.
- Kowol D., 2011. *Influence of fluctuations of the feed on operation of a float-based discharge control system in a jig*. PhD thesis, Silesian University of Technology, Gliwice.
- King R.P., 2001. *Modeling and simulation of mineral processing systems*. Butterworth & Heinemann.
- Srinivasan R., Mishra B.K., Mehrotra S.P., 1999. *Simulation of particle stratification in jigs*. Coal Preparation 20.
- Xia Y., Peng F.F., Wolfe E., 2007. CFD simulation of fine coal segregation and stratification in jigs. International Journal of Mineral Processing 82.
- Woollacott L.C., Bwalya M., Mabokela L., 2015. A validation study of the King stratification model. J. S. Afr. Inst. Min. Metall. 115, 2, Johannesburg.