



Residence Time Distribution Model of Dual Phase Fluid Flow in the Mixer Settler

Mehdi ALIZADEH¹⁾, Mostafa HOSSEINZADEH²⁾

¹⁾ Materials and Energy Research Center; Tehran, Karaj, Iran; e-mail: mehdializadeh@merc.ac.ir

²⁾ Materials and Energy Research Center; Tehran, Karaj, Iran; e-mail: mostafac12@yahoo.com

Summary

In this study, the residence time distribution of the fluid stream in a mixer settler was simulated in order to achieve the optimal extraction time and the best performance. The aqueous and organic phases were water and kerosene, respectively; and the salt tracer changes were recording continuously by using a conductivity meter. Initially, experiments were performed at different mixing times in the phase ratio of 1:1. Then, results were analyzed applying Matlab software and Weller and N-Mixer models in RTDWEN software. Finally, for the mixing period of 5 min, the mean residence time was obtained 4.86 min by Matlab, and 6.44 and 6.62 min by RTDWEN, respectively for Weller and N-Mixer models. Furthermore, setting the mixing period at 5 min, the effect of mixer settler units was investigated by using N-Mixer model, and it was found that it was beneficial to increase the number of units, and set the residence time distribution close to extraction time at 6 min. It was also shown that under these conditions, the removed material from the mixer before the mean residence time was minimum, and both phases have an enough time for mixing and settling.

Keywords: Simulation, RTD model, RTDWEN, Matlab, Mixer Settler

1. Introduction

Residence time is one of the most important issues in the industrial and engineering projects such as, Mineral Processing, Metallurgy, chemistry and etc. (Levenspiel, 1999). In general, when a fluid flows into a container with a fixed volume, depending on the type of flow into container, each particle is removed from it after a certain time of arrival. This time is not constant for different particles. In fact, mean residence time means average of substances residence time of fluid in the reaction container. (Dell Villar et al, 1984; Kelly and Spattiswood, 1989; Nasset, 1988). To obtain information about the fluid flow pattern and residence time distribution (RTD) of substances in it, one of the basic factors is in the design and control of the reaction containers. Ideally, there are the two methods for determination of residence time distribution (Levenspiel, 1999):

1. When there is no mixing during fluid flow (plug flow),
2. When there is complete mixing in the reaction container (perfect mixer).

Most systems performance in real situation is between the plug flow and the perfect mixer. In these cases, residence time distribution in system cannot

be obtained by using the basic principles. It is usually determined by testing. Thus, the reagent is added at the input of the system then the concentration is measured at different times. Finally, mean residence time is determined by mathematical models. Usually, models are composed of a series of containers that are arranged in series. The most common models used in this field include: Weller and N-mixer models (Levenspiel, 1999; King, 2001).

1.1. Weller model

This model has composed of a container with plug flow (τ_{PF}), two small containers with perfect mixer flow (τ_S) and a big container with perfect mixer flow (τ_L) in series. Residence time distribution function for this model represented by the equation 1.

1.2. N-Mixer model

This model also has composed of a container with plug flow (τ_{PF}) and n containers with perfect mixer flow (τ). Residence time distribution function for this model represented by the equation 2.

Knowing the substance residence time in the reaction container has an important effect on the efficiency and increase productivity system and also improves extraction operations. Thus, in this study

$$RTD(t) = \left[-\frac{t - \tau_{PF}}{\tau_S} \exp\left(-\frac{t - \tau_{PF}}{\tau_S}\right) - A \exp\left(-\frac{t - \tau_{PF}}{\tau_S}\right) + A \exp\left(-\frac{t - \tau_{PF}}{\tau_L}\right) \right] \left(\frac{A}{\tau_L} \right) \quad A = \frac{\tau_S}{\tau_S - \tau_L} \quad (1)$$

$$RTD(t) = \frac{n^n (t - \tau_{PF})^{n-1} \exp\left(\frac{-n(t - \tau_{PF})}{\tau_{\Sigma}}\right)}{(\tau_{\Sigma})^n (n-1)!} \quad \tau_{\Sigma} = n\tau \quad (2)$$

simulation of residence time distribution of substances in a mixer settler system was performed in the phase ratio 1:1 of aqueous phase to the organic phase and was tested different flows and mixing times. In finally, an optimum flow and residence time was obtained.

2. Materials and methods

NaCl was used as the detector reagent in aqueous phase to obtain the residence time distribution of substances in the mixer settler (Fig. 1). The aqueous and organic phases were water and kerosene, respectively.

The aqueous and organic phases have been transferred to mixer settler by using peristaltic pumps Ismatec (ISM831C model) made in U.S. The salt

tracer changes were recorded continuously by using an electrical conductivity meter (model 712), made in Metrohm Co. in Switzerland.

After the aqueous and organic phases were adjusted in phase ratio 1:1, the mixer settler was turned on until it reaches a steady state then two ml of saturated salt solution was added to the output of mixer in a second and Measurement of electrical conductivity of the aqueous phase of the output of the mixer was performed continuously by using electrode conductivity meter (Fig. 2). The amount of salt added to the water was so that the changes in the electrical conductivity of solution could be 5–6 times the electrical conductivity of water. To ensure that all the reagents in the mixer were measured, Meas-

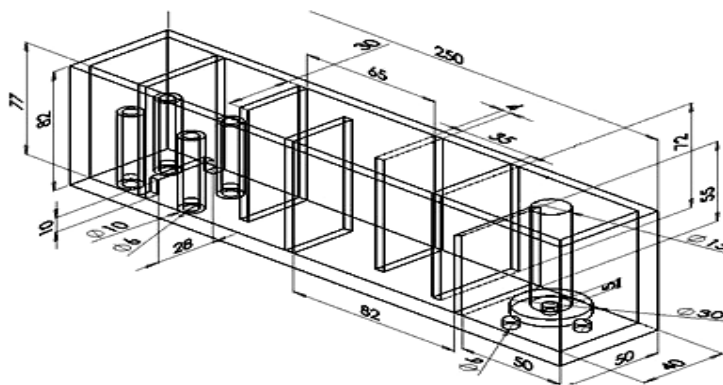

Fig. 1. Schematic picture of the mixer settler used in the experiments (dimensions in mm)

Rys. 1. Schemat osadnika użytego w eksperymentach (wymiary w mm)

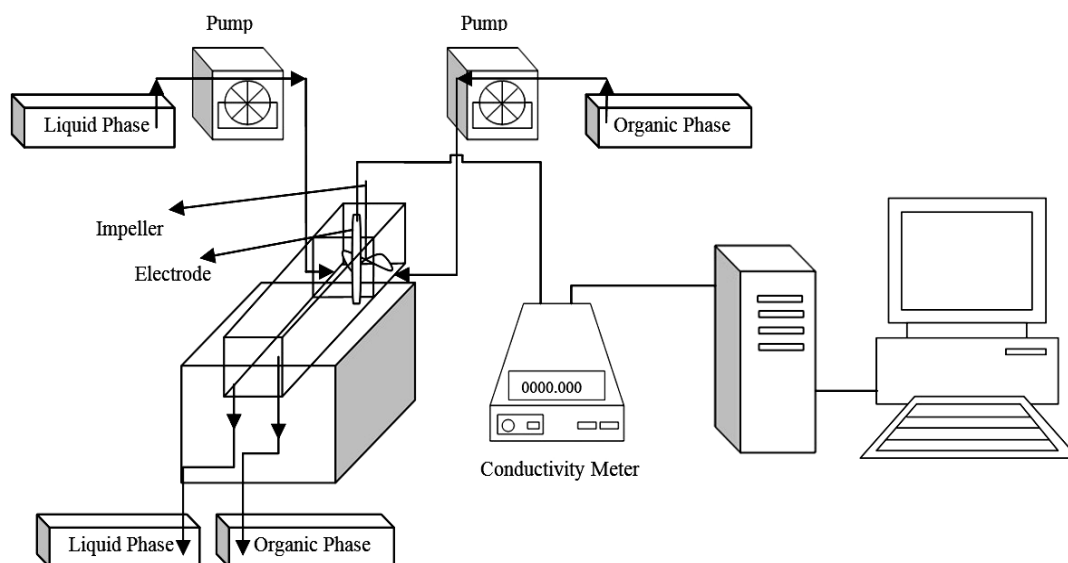

Fig. 2. Schematic picture of the tracing method used for RTD measurement in the mixer settler

Rys. 2. Schemat metody śledzenia użytej w pomiarze RTD w osadniku

urement of the electrical conductivity of the aqueous phase output was performed 2–3 times the mixing time considered for each test.

According to the obtained experimental results during the our previous work in the batch mode (data not published), After 6 minutes of the start of the mixing process of two –phase, The extraction rate has been fixed at 95%. Thus, the experiments were performed until the mixing period of 7 min to achieve an optimum fluid flow rate and residence time for extraction operations in continuously mode in the mixer settler. Having electrical conductivity data at different times in all experiments, results were analyzed applying Matlab software and Weller and N-Mixer models in RTDWEN software and were showed in the form of statistical parameters.

3. Results and discussion

3.1. Residence time distribution experiments in the mixer settler

Table 1 lists the results of the analysis of the electrical conductivity data at the different mixing periods of the simulation experiments in Weller and N-Mixer models in RTDWEN software.

The results indicated that mean residence time of mixing period of 5 min in both Weller and N-Mixer models could provide sufficient time to perform extraction process and mass transfer from the aqueous phase to the organic phase in the mixer (Fig. 3).

Matlab software also showed a great fit (fitted with 95%) based on data obtained from the electrical conductivity vs. mixing period of 5 min with the equation 3.

Therefore, the Matlab software showed a suitable condition with the sum of squares error of 0.02, standard deviation of 3.4 and the mean time of 4.86 min for mixing of two phases at 5 min (Fig. 4).

Based on these results for the mixing period of 5 min, N-Mixer model was chosen to show the movement pattern of fluid flow inside the mixer settler. So, considering the operational volume of mixer (120 ml) and by using the equation of the volumetric flow rate in the phase ratio of 1:1 (Equation 4).

3.2. Effect of mixer settler units

N-Mixer model was used to evaluate the effect of the number of cells in the substances residence in the

Table 1. RTD results in RTDWEN software in simulation experiments

Tabela 1. Wyniki symulacji RTD w programie RTDWEN

Weller									N-Mixer								
Parameter	Time (min)								Parameter	Time (min)							
	0.5	1	2	3	4	5	6	7		0.5	1	2	3	4	5	6	7
τ_{PF}	0	0	0.08	0.03	0.01	0.04	0.1	0.01	τ_{PF}	0	0.15	0	0	0.67	0.67	0	1.25
τ_L	0.59	1.11	1.1	3.24	4.53	3.99	7.18	8.52	N=	3	1.25	1.1	1.03	1.01	1.01	1.13	1.01
τ_S	0.03	0.05	0.14	0.16	0.2	0.2	0.23	0.33	τ_{PM}	0.56	0.99	2.1	3.31	4.52	5.96	7.09	8.6
τ_{ave}	0.64	1.2	2.53	3.58	4.95	6.44	7.88	9.19	τ_{ave}	0.56	1.15	2.11	3.31	5.20	6.62	7.09	9.85
Var. ¹	0.35	1.24	4.02	10.5	20.6	35.9	51.7	72.8	Var.	0.93	1.23	4.78	11.3	20.7	35.9	57	75.1
R.V. ²	0.84	0.86	0.72	0.82	0.84	0.87	0.83	0.86	R.V.	0.33	0.63	0.93	0.97	0.75	0.80	0.88	0.75
R.R.E ³	0.1	0.1	0.06	0.09	0.11	0.14	0.1	0.09	R.R.E	0.30	0.04	0.19	0.17	0.05	0.09	0.15	0.04
S.S.E ⁴	0.05	0.02	0.12	0.1	0.05	0.09	0.12	0.07	S.S.E	0.03	0.01	0.02	0.04	0.02	0.06	0.03	0.04

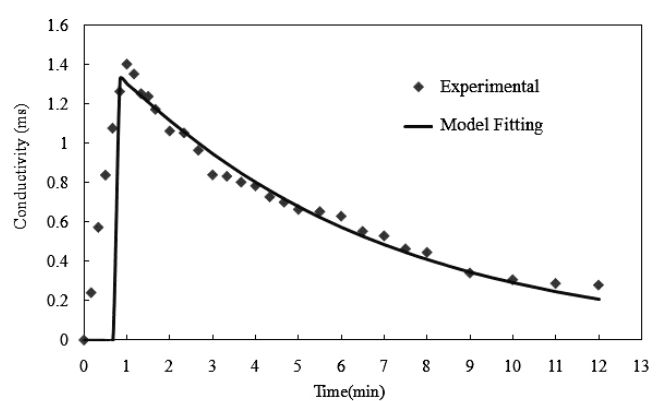
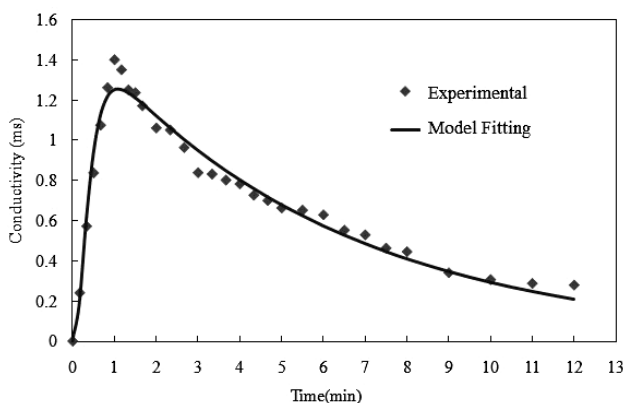

Fig. 3. RTD in mixer by Weller model (left-hand) and N-Mixer model (right-hand) at the mixing period of 5 min

Rys. 3. Model RTD w mieszalniku według modeli Weller (po lewej) i N-Mixer (po prawej) w czasie mieszania równym 5 min

$$f(x) = (51.36x^2 + 67.44x + 13.09) / (x^4 - 7.987x^3 + 110.2x^2 - 93.83x + 79.68) \quad (3)$$

$$Q_{\text{total}} = \frac{V_{\text{ope.}}}{\tau_{\text{ave.}}} = 18.13 \text{ ml/min} \rightarrow Q_{\text{aq}} = Q_{\text{org}} \square 9 \text{ ml/min} \quad (4)$$

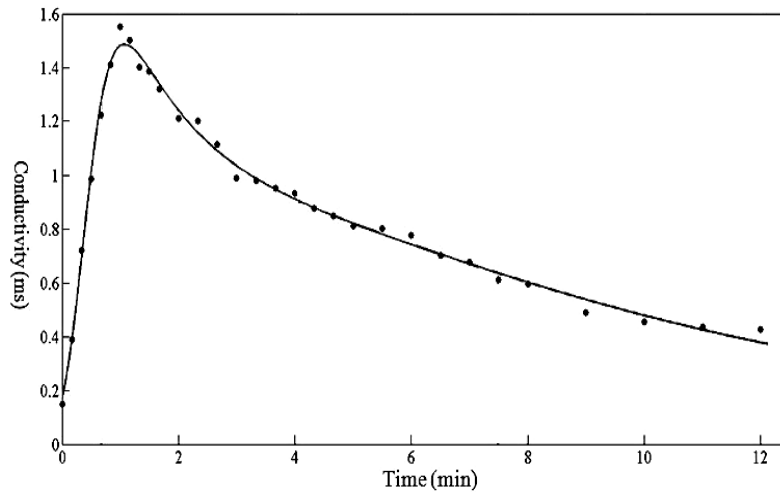

Fig. 4. RTD in mixer in Matlab software at the mixing period of 5 min

Rys. 4. RTD w mieszalniku w programie Matlab w czasie mieszania równym 5 min

mixer due to having infinity perfect mixer containers (n) and its good fitting. In all calculations were used of the results of mixing period of 5 min of N-Mixer model in table 1 (Fig. 5).

As can be seen from Figure 8, with increasing the number of perfect mixer containers, flow performance could be like the plug flow and substances residence time in the mixer are close to each other. In fact, in this case it is reduced rate of substances that are existed earlier or later of mean residence time. As a result, short circulating is decreased and increased system efficiency.

3.3. Mixer settler system performance

3.3.1. N-Mixer model

In N-Mixer model, to understand how much substances earlier or later of mixing period of 5 min will be removed from mixer, it was got integration from residence time distribution function of N-Mixer model by Matlab software. Thus, in the lower range of the mean residence time for $n=1$ represented by the equation 5, (Fig. 6).

It means 69.88% substances are removed from mixer in time range zero to mean residence time in N-Mixer Model (This value decreases with increase

$$\int_0^{6.62 \text{ min}} \text{RTD (NMixer)} = 0.6988 \quad (5)$$

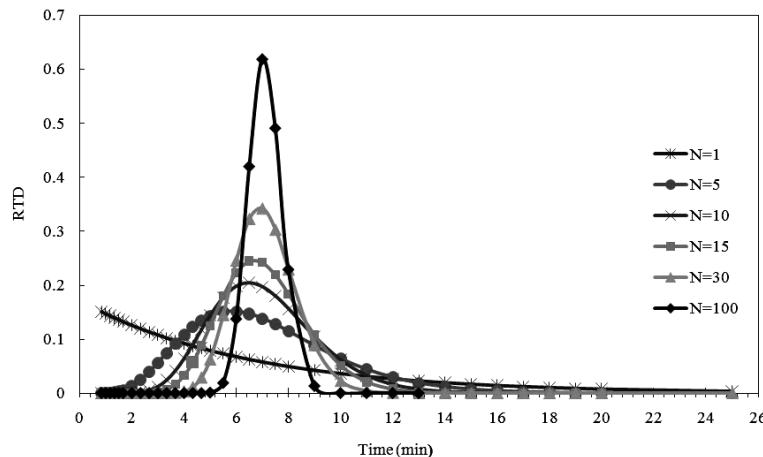

Fig. 5. Effect of the number of perfect mixer containers (n) in N-Mixer model on RTD in mixer

Rys. 5. Wpływ ilości mieszalników doskonałych (n) w modelu N-Mixer na RTD w mieszalniku

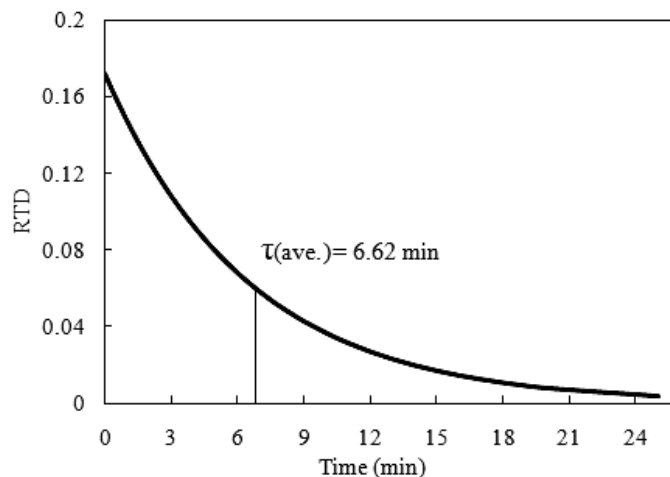

Fig. 6. RTD in N-Mixer model at the mixing period of 5 min with $n=1$
 Rys. 6. RTD w modelu N-Mixer w czasie mieszania równym 5 min i $n=1$

$$\int_0^{2\text{min}} \text{RTD}(\text{NMixer}) = 0.2882 \rightarrow 28.82\% \quad (6)$$

of n). Based on our previous work (data not published), after 30 second of start of extraction process has been obtained extracting up to 90%. So, it can be expected that has been performed the mass transfer operations.

In these experiments, when the two -phase mixing time was less than 2 min was formed relatively stable emulsion that it was required several hours for the complete separation and settling. Therefore, if it is been more the substance that are removed of mixer in this time range, length and thickness of band dispersion increases in the settler, so it is needed to more space and place for complete separation of the two phases. Substance removed in this time range in N-Mixer model for $n=1$ represented by the equation 6.

If it is chosen $n=4$, the result reduces to 78%. Thus, it is seen that is decreased the substance that is removed of mixer in less than mixing period of two min by increasing the number of cells. Therefore, less stable emulsion is formed and is reduced the required time for complete separation and settling.

4. Conclusion

The results showed that N-Mixer model can be used as movement pattern of fluid flow in the mixer

settler and provides the required time for extraction process and mass transfer at the mixing period of 5 min. Also, the values obtained from the simulation data at the time of incorporation in Matlab software confirmed results of RTDWEN software. With increasing n in the N-Mixer model was determined that mean residence time of substances in mixer are closed to each other and experimental extraction time of 6 min. So, if the numbers of mixer settler units are been more, the fluid flow is closed to plug flow. It was also shown that under these conditions, it is decrease the substances that are caused the formation of stable emulsion and increase of separation and settling time, Due to lack of sufficient time for mixing. Thus, thickness band dispersion decreases and both phases have an enough time for separation and settling.

Acknowledgements

The Authors wish to thank Materials and Energy Research Center (MERC) management for their cooperation in this study.

Literatura – References

1. Levenspiel O.: *Chemical reaction engineering, 3rd edition. U.S.A. : John Wiley and sons, 1999, p. 90-120, ISBN 0-471-25424-X.*
2. Dell Villar, R. et al. *Residence time distributions in closed circuit ball mills, 23rd Aannual Conference of Met., Quebec, Canada, 1984, p. 19-22.*

3. Kelly, E. G. & Spattiswood, D. J. *Introduction to Mineral processing*, 1989, 152, p. 52-57.
4. Nasset, J. E. *The application of residence time distributions to flotation and mixing circuits*, *CIM Bull*, 1988, 81, p. 75-78.
5. King, R. P. *Modeling and simulation of mineral processing systems*. 1st edition. U.S.A.: Butterworth-Heinemann, 2001, p. 174-186, ISBN 0-7506-4884-8.

Model RTD (Rozkład Czasu Przebywania) do opisu dwufazowego przepływu w osadniku

W badaniu zasymulowano rozkład czasu przebywania strumienia płynu w osadniku w celu osiągnięcia optymalnego czasu ekstrakcji i najlepszej wydajności procesu. Fazami wodnymi i organicznymi były odpowiednio woda i nafta; zmiany wskaźnika kwasowości były rejestrowane w sposób ciągły dzięki użyciu konduktometru. Początkowo eksperymenty przeprowadzono przy różnych czasach mieszania przy stosunku faz 1:1. Następnie wyniki analizowano stosując środowisko programu Matlab oraz modele Weller i N-Mixer w programie RTDWEN. Finalnie, dla czasu mieszania wynoszącego 5 minut, otrzymano 4,86 min w programie Matlab oraz 6,44 i 6,62 min w programie RTDWEN odpowiednio dla modeli Weller i N-Mixer. Co więcej, po ustawieniu czasu mieszania na 5 min badano efekt jednostek osadnika przez użycie modelu N-Mixer i dowiedziono, że korzystne było zwiększenie liczby jednostek oraz nastawienie czasu rozkładu zbliżonego do czasu ekstrakcji wynoszącego 6 min. Pokazano również, że w tych warunkach materiał usunięty z mieszalnika zanim właściwy czas przebywania był minimalny, a obie fazy miały wystarczająco dużo czasu na mieszanie i osadzanie.

Słowa kluczowe: symulacja, model RTD, Rozkład Czasu Przebywania, RTDWEN – oprogramowanie, Matlab, osadnik