



---

**Article citation information:**

Olczykowski, Z., Wojciechowski, J., Młyńczak, J. Reliability and quality of the power supply for rail transport. *Scientific Journal of Silesian University of Technology. Series Transport*. 2017, **96**, 139-149. ISSN: 0209-3324. DOI: <https://doi.org/10.20858/sjsutst.2017.96.13>.

Zbigniew OLCZYKOWSKI<sup>1</sup>, Jerzy WOJCIECHOWSKI<sup>2</sup>, Jakub MŁYŃCZAK<sup>3</sup>

## RELIABILITY AND QUALITY OF THE POWER SUPPLY FOR RAIL TRANSPORT

**Summary.** The subject of this paper deals with the reliability of the power supply and quality of electricity on the railway networks. The paper discusses the impact of changes in the area of traction substation load on parameters characterizing the quality of electricity. It analyses the quality of electricity in supply networks for the traction substation, as well as on auxiliary lines and in trackside power supply. Particular attention is given to the propagation of interference caused by traction DC appliances for the trackside power supply. This is important due to the fact that these networks provide the power supply for devices that are responsible for the safety of train traffic. The paper also discusses the impact of major failures (blackouts) in power systems on transport, especially rail transport.

**Keywords:** rail transport; power supply reliability; blackout power quality

### 1. INTRODUCTION

Electric traction, being one of the largest consumers of electricity, requires power to be supplied from two independent sources. Once converted to DC, a significant part of the

---

<sup>1</sup> Faculty of Transport and Electrical Engineering, Kazimierz Pulaski University of Technology and Humanities, Malczewskiego 29 Street, 26-600 Radom, Poland. E-mail: [z.olczykowski@uthrad.pl](mailto:z.olczykowski@uthrad.pl)

<sup>2</sup> Faculty of Transport and Electrical Engineering, Kazimierz Pulaski University of Technology and Humanities, Malczewskiego 29 Street, 26-600 Radom, Poland. E-mail: [j.wojciechowski@uthrad.pl](mailto:j.wojciechowski@uthrad.pl)

<sup>3</sup> Faculty of Transport, The Silesian University of Technology, Krasińskiego 8 Street, 40-019 Katowice, Poland. E-mail: [jakub.mlynczak@polsl.pl](mailto:jakub.mlynczak@polsl.pl)

energy supplied from the power system to a traction substation is used for driving the traction units. The remainder is used for the substation's auxiliaries and for operating trains. Surpluses are sold to other customers; the trackside power supply is used for this purpose.

Due to the nature of the substation, which includes non-linear elements (rectifiers) and considerable loads, electric traction impacts on the power system from which it is powered. By pulling deformed currents, it introduces higher harmonics in the network. Rapid power changes, resulting from starting up a train set, for example, cause further fluctuations and voltage dips. These disturbances are felt both in the substations' supplying systems and in the auxiliary lines and trackside power supply. The propagation of disturbances in the trackside power supply affects the equipment supplied from this supply. This is particularly important, since the trackside power supply supplies train traffic control equipment. Railway interlocking devices have a direct impact on rail transport safety [9,17].

A very important issue concerning all transport areas, especially rail transport, is power supply reliability. The lack of electricity supply completely immobilizes trains that use electric traction. The longer the power outage, the more severe impact it has on passengers. When power systems covering large areas fail for a period of several days (blackout), a massive transport chaos ensues. From rail, air, public to individual forms of transportation, everyone depends on electricity supply. This is particularly detrimental in large metropolitan areas, where a large number of passengers must be carried at one time. In the case of a failure lasting several days, rail transport based on diesel locomotives can be one of the main measures to ensure delivery of food, medicines and fuel for cities deprived of electricity. In such a case, it is very important to provide power for railway interlocking.

## **2. ELECTRIC POWER QUALITY ASSESSMENT CRITERION**

The norm EN-50160 [5] was assumed to be an assessment criterion of electric power quality. This norm concerns the parameters of supplying voltage occurring in public distribution networks. This norm also determines the voltage parameters of low (up to 1 kV) and medium (from 1 to 35 kV) voltage networks. The norm specifies voltages measured in supplying points (connectors) and conditions of nominal operation of supplying networks. Presented in the norm recommendations are the following allowable values of voltage parameters of low- and medium-voltage networks: frequency of voltage, value of voltage, the change of voltage, fast changes in voltage, subsidence of voltage, short-term interruptions in supplying voltage, long-term interruptions in supplying voltage, instantaneous overvoltage between wires of networks and the earth, transient overvoltage between wires of the networks and the earth, asymmetry of supplying voltage, the influence of the harmonics of voltage and the voltage signal on supplying voltage, and their use in transmitting information.

On the basis of the EN 50160 norm, Polish regulations determining the basis parameters of electric power quality have been elaborated [11,13].

## **3. ANALYSERS AND PLACES FOR THE MEASUREMENT OF ELECTRIC POWER QUALITY**

Measurements of electricity quality indicators, analysed in the article, were carried out on the power supply networks of various traction substations. According to the EN 50160 norm, devices having special certificates and meeting the norm of network parameters should be

used to record parameters. The records should be performed over at least a period of one week. Power quality indicators were also recorded during short measurement intervals. This allowed us to assess the impact of dynamic substation load changes on energy quality. Fig. 1 shows the part of the substation supplying system along with the places of meter connection.

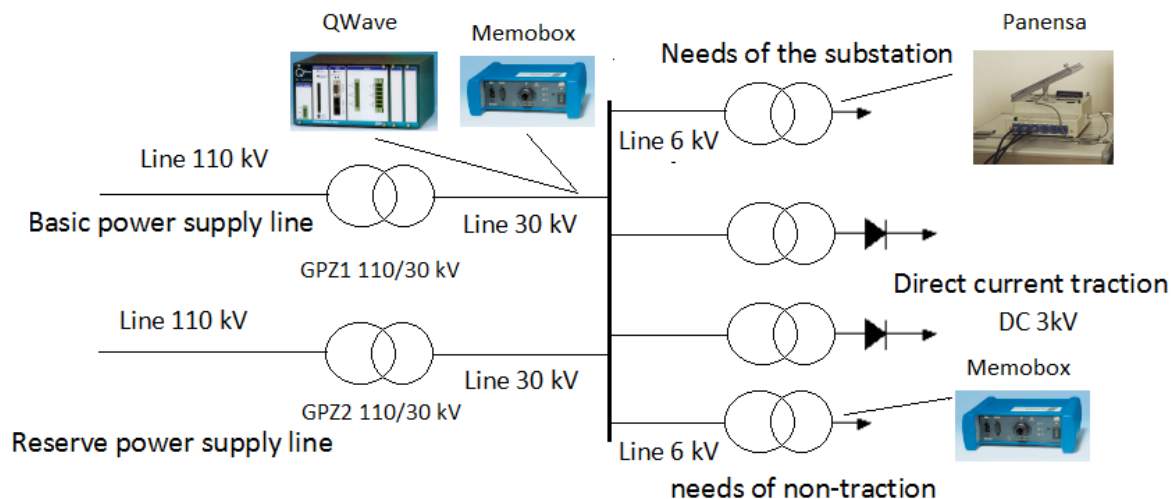

Fig. 1. Places of measurement of electric power quality

Two kinds of electric power quality meters (Memobox 800 and QWave), as well as the Panensa-MEF flickermeter, were used for measurement purposes. The analysers were connected by current and voltage transformers to the following circuits: supply lines for the substation; line of own needs; and non-traction networks.

#### 4. ANALYSIS OF MEASUREMENT DATA

The traction system is closely linked to the supply system of power lines. No voltage in the power grid automatically affects the traction line, which makes power redundancy a must. However, there is an inverse relationship present. A system of rectifier units or substation load changes on the DC side affect(s) the quality of electricity in substation feeders, and may cause interference in electric appliances on the low-voltage side, powered from auxiliary transformers and trackside transformers. Below is an analysis of changes in the basic electricity quality indicators.

##### 4.1. Power lines for the traction substation

The power system is connected to the DC traction in the traction substation supply grids. Most of the substations are powered by medium-voltage lines. For a single-stage transformation of energy, the traction's impact on the power system is smaller. This is due to the higher short-circuit capacity at the interconnection point.

An analysis of measurement results recorded in the substation feeders with six-pulse rectifier systems is given below.

Fig. 2 shows a summary of the electricity quality indicators recorded during a week-long measurement cycle.

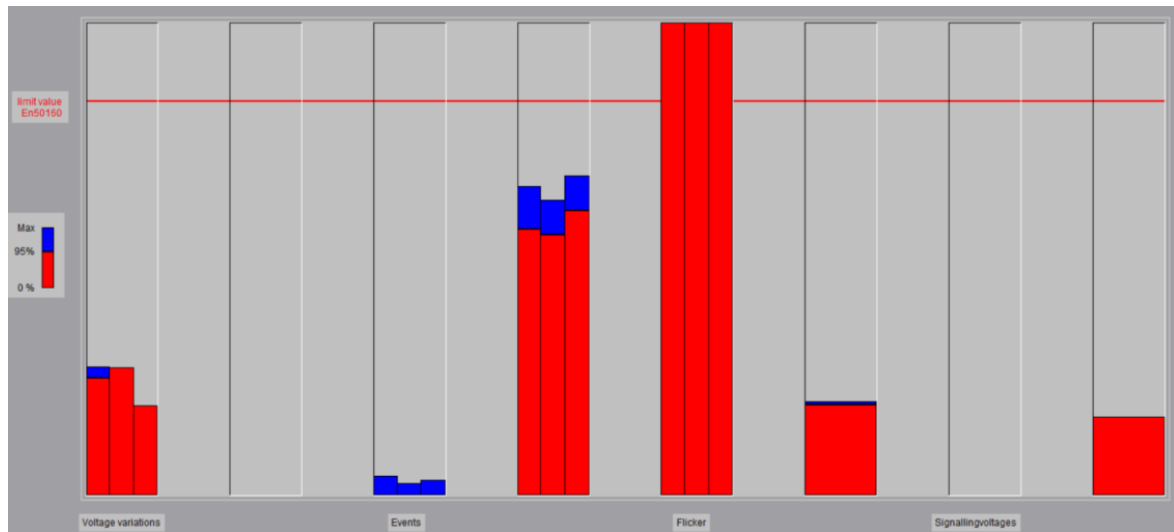

Fig. 2. Summary of the electricity quality indicators recorded during a week-long measurement cycle

During measurements, the higher harmonics of the supply voltage were recorded (see Fig. 3). This is due to the influence of rectifiers installed at the substation. On the voltage spectrum, there are harmonics (5,7,11,13,17,19,23,25) that are characteristic for six-pulse rectifiers.

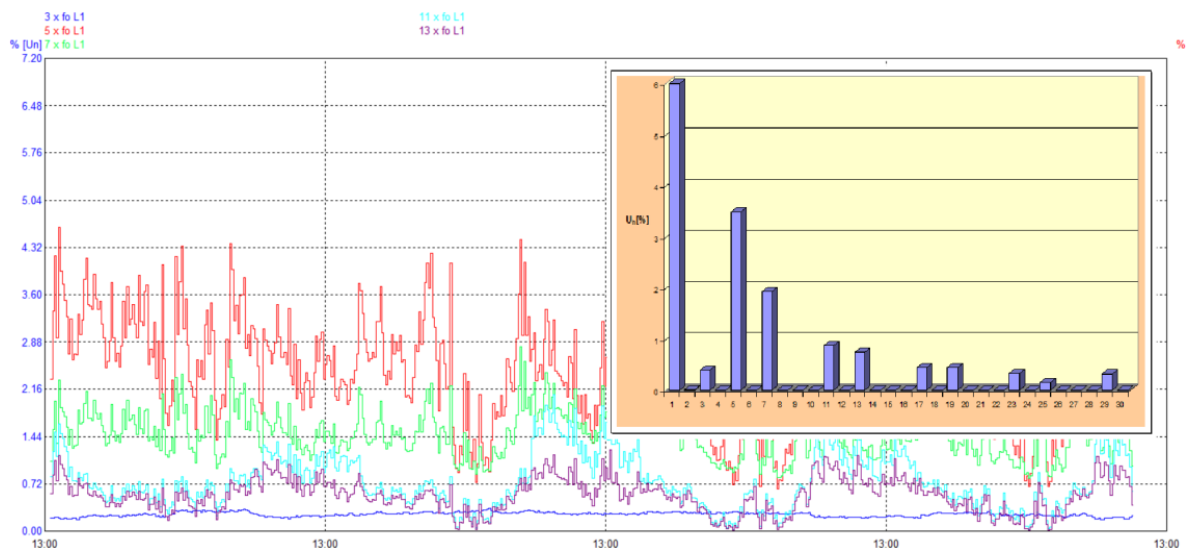

Fig. 3. The higher harmonics of the voltage in the power supply line of the traction substation

The measurements also registered higher flicker indicators (Fig. 4), which is indicative of fluctuations or voltage dips (see Table 1).

Tab. 1

## Voltage dips measurements in the power supply line of the traction substation

Phase L1, L2, L3	< 20 ms	20...< 100 ms	100...< 500 ms	0.5...< 1 s	1...< 3 s	3...< 20 s	20...< 60 s	>= 1 min
Surge > 10.00%	5	2	2					
Dip > 10.00%								
10...< 15 %								
15...< 30 %	1							
30...< 60 %	1		1					
60...< 99 %								
Interruption								

Recording as events from -10.00/+10.00% of the nominal voltage  
 Dip according to UNFPEDE measurement guide

Number of surges	9
Number of Dips	3
Number of short interruptions (<3 min)	0
Number of long interruptions (>=3 min)	0
Number of interruptions	0
Total events and interruptions	12
Total number of allowed events	100
Total number of allowed interruptions	100

The measurements also registered higher flicker indicators (Fig. 4), which is indicative of fluctuations or voltage dips (see Table 1). During one of the events, the substation's supply voltage decreased by more than 40%, down to 17,906 V.

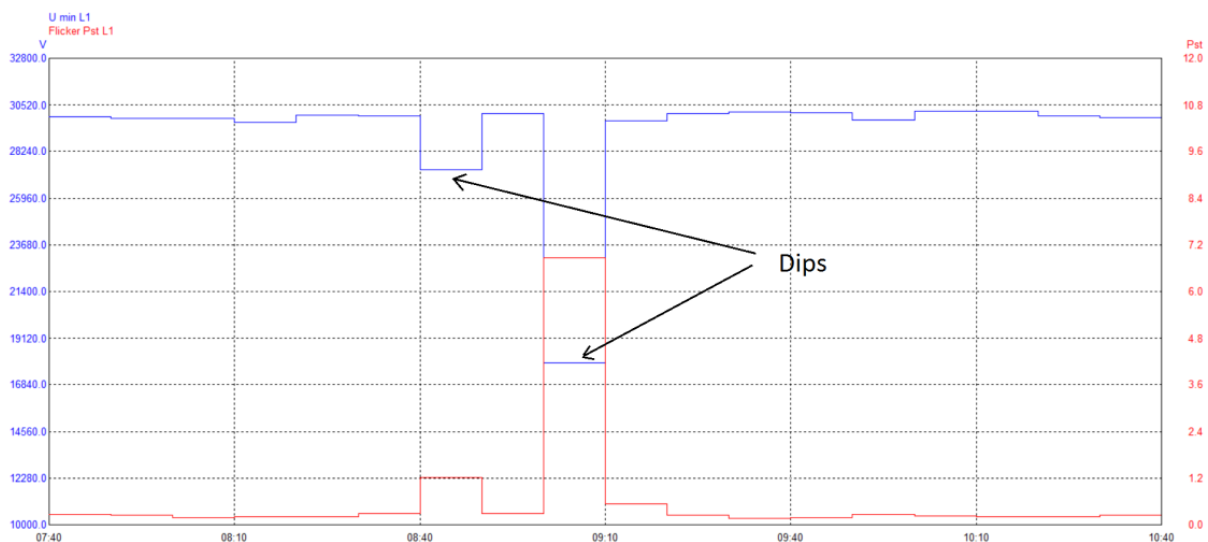
Fig. 4. Voltage changes and short-term light flicker  $P_{st}$ 

#### 4.2. Line of traction substation needs

The main task of a traction substation is to convert AC voltage to DC voltage, as well as deliver it to the railway traction network. An additional task of the traction substation is powering different non-traction objects with, for example, AC 230/400 V electricity for powering its auxiliaries, which is provided by two auxiliary transformers. These transformers supply auxiliary circuits, which are essential for the operation of the traction substation (e.g., safeguards, control and signalling circuits), most of which are powered by DC voltage. The operation of these devices (especially older ones) is slightly affected by the quality of power that supplies the substation, alongside disturbances associated with the substation's variable load. However, the introduction of modern safeguard equipment, control devices and data transmission devices increases power quality requirements.

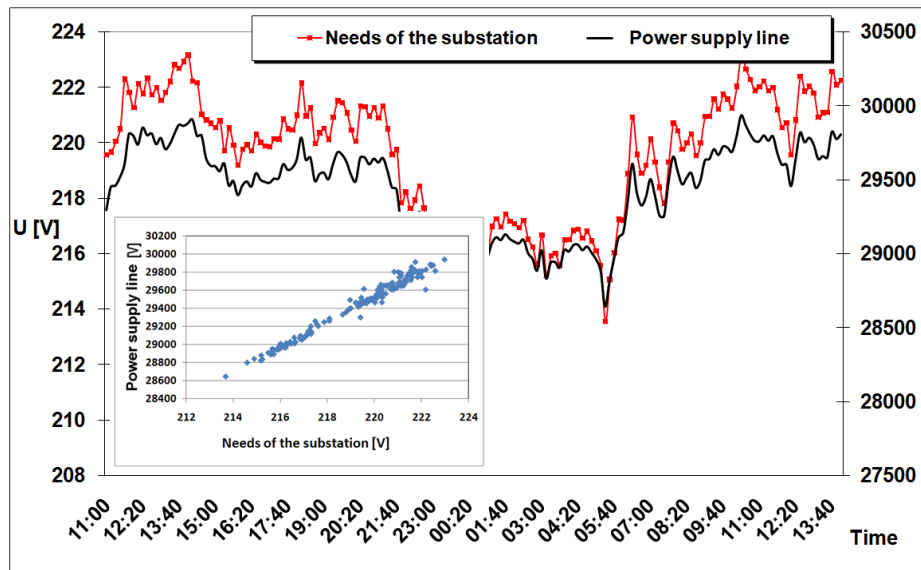

Fig. 5. Voltage fluctuations on power lines of the traction substation and its line of own needs

Voltage fluctuations in the own-demand circuits are closely related to voltage changes in the supply line of the substations (see Fig. 5). The correlation coefficient between the voltages is 0.989 (Fig. 5 in decreasing order).

#### 4.3. Trackside power supply

Unlike the devices connected to the auxiliary circuits, the trackside power supply supplies various appliances (with variable power input, pulling deformed currents, sensitive to disturbances). For this reason, appropriate supply voltage parameters must be guaranteed to a greater extent than in auxiliary circuits. As shown later in this paper, the trackside power supply circuits are also affected by disturbances resulting from the rectifier units (limitation of the fifth and seventh harmonics for 12-pulse sets) and changing substation load. In addition, we have disturbances caused by appliances connected to the trackside power supply circuits. This is particularly important for small short-circuit capacities at the interconnection point.

PKP Energetyka holds licences issued by the Energy Regulatory Office for the distribution, transmission and trading of electricity. Using trackside power supplies, it sells electricity to other consumers in the energy market. For this, an appropriate quality of electricity must be ensured [11].

Fig. 6 shows the voltage waveform in one phase of the trackside power supply. There were three voltage dips, as confirmed by the UNIPEDE table and the waveform of one of the dips in reduced size (see Fig. 6). The voltage dips were caused by rapid changes in the load of the traction substation.

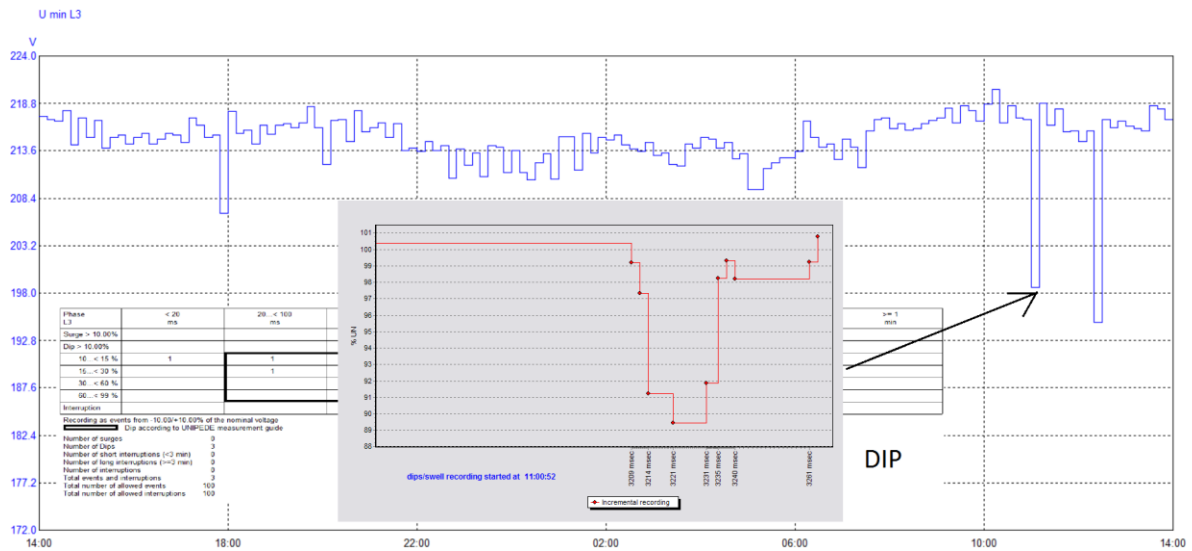

Fig. 6. Changes and dip voltage in the network of non-traction needs

Voltage dips and short power cuts are one of the most common disruptions in power grids. Being highly random, they are virtually impossible to eliminate. Limiting the effects of these disruptions requires large financial outlays. For computer equipment used to supervise railroad traffic control systems, an uninterrupted power supply becomes a must. In trackside power networks, the main cause of voltage dips is the dynamically changing load of the traction substation.

As in the case of auxiliary networks, the non-linear nature of the traction substation causes the propagation of higher harmonics. Depending on the rectifier units used, characteristically higher harmonics are generated. Fig. 7 shows the percentage change in voltage higher harmonic content, recorded during one of the measurement cycles. In the smaller box, the higher harmonics spectrum for the measured voltage is shown.

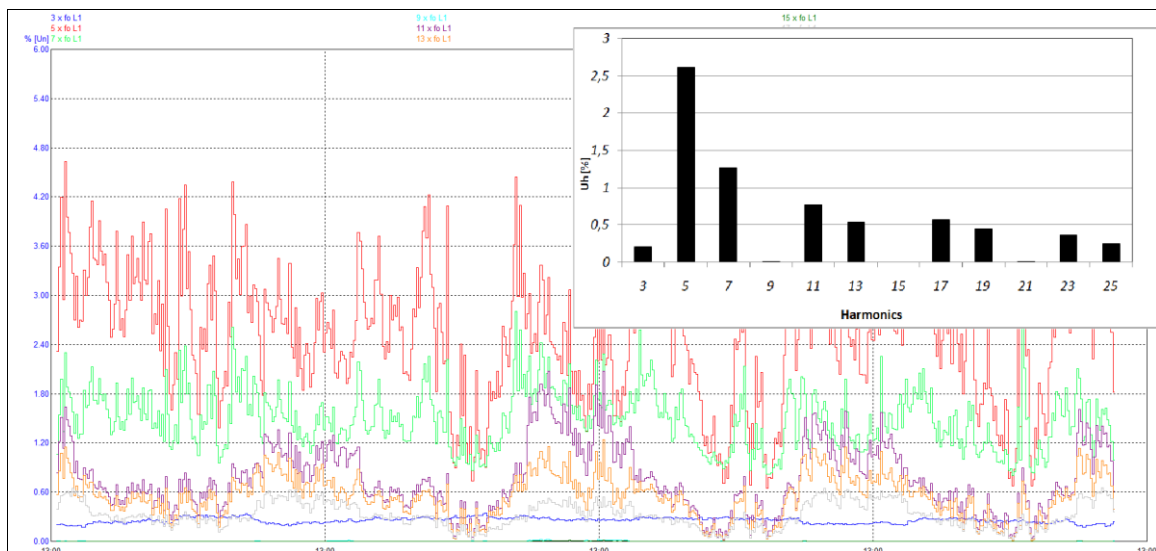

Fig. 7. Higher harmonics and voltage spectrum recorded on the line of non-traction needs



The voltage harmonics spectrum is characteristic for six-pulse rectifier units. This spectrum is similar to the spectrum of voltage measured on the traction substation's auxiliary circuits. Voltage waveform deformation directly affects the lifespan of electricity appliances. It is assumed that a voltage deformation of THD=10% will reduce the lifespan of single-phase motors by approximately 30%. Substantial voltage distortions also cause many other risks.

## 5. RELIABILITY OF POWER SUPPLY FOR RAIL TRANSPORT

Electric traction is one the appliances requiring increased supply reliability. This is secured by two independent power lines fed into the traction substation (see Fig. 1). If the primary power supply fails, the substation automatically switches to the backup line. Feeding power into the substation in this way makes operating trains possible if one of the power lines fails.

However, there are more and more situations where consumers without power are in the order of thousands or even millions. During a blackout in the US and Canada between 14 and 16 August 2003, more than 55 million people had no power [7,2,1]; in Italy, on 23 September 2003, more than 57 million were affected [8,9]; and in Brazil, between 14 and 15 March 1997, more than 97 million were affected. During the biggest blackout in India from 30 to 31 July 2012, more than 700 million people were affected [14,15,16]. Moreover, these power cuts were so prolonged that they endangered human life and caused substantial financial loss. One of the areas of the economy that depends on electricity to a large extent is transportation. Once we could distinguish between transport sectors that are directly dependent on electricity, such as rail transport. Now, when there are system failures (blackouts), we are dealing with a major transport chaos (see Fig. 8).



Fig. 8. Looking like a scene from a post-apocalyptic film, droves of people walked were forced to cross the Brooklyn Bridge to get in and out of Manhattan [8]

Following the many blackouts around the world, restoring the power was not be achieved swiftly. Thousands of passengers had to be evacuated from subway cars and passenger trains. Many were stranded at stations and airports (see Fig. 9).





Fig. 9. Passengers sit on a railroad track in India waiting for power to return after a massive blackout in late July 2012 [4]

Poland experienced a major power system failure between 7 and 8 April 2008. Severe ice build-up damaged power lines supplying the Szczecin agglomeration, leaving more than 650,000 people without power. As in the case of other incidents, the lack of energy supply caused traffic chaos in all transport sectors. The costs of the failure were estimated at over PLN 100 million [12].

## 6. CONCLUSION

Rail transport is highly dependent on electricity supplies from the power system. Disturbances and failures in traction substation supply lines directly affect the operation of trains and the entire railway infrastructure. IT equipment and railway control engineering are particularly sensitive to these disturbances [10]. If a power failure affects a large area of the national power system, resulting in a blackout, railway transport is brought to a virtual halt. It is then that diesel engine train sets must be used, with railroad traffic control being provided by backup power, given that electricity generators provide power to traffic control equipment.

Given its power and load, electric traction brings into the system all kinds of disturbances. These disturbances are also propagated within auxiliary networks and trackside power supplies. These are mainly higher harmonics that result from using rectifiers in traction substations, as well as voltage fluctuations and dips. They reduce the quality of electricity. The right power quality must be guaranteed, especially in trackside power supplies. These supplies provide power to traffic safety equipment and other non-railway consumers. Improving the voltage parameters is very expensive in many cases. Replacing old rectifier units with new ones or using single-stage energy transformation will often limit the traction's impact on the power system. Increasing the cost towards improving the railway infrastructure responsible for operating trains seems to be inevitable.

## References

1. DeBlasio Allan J., J. Regan Terrance, Margaret E. Zirker, Katherine S. Fichter, Kristin Lovejoy. 2003. *Effects of Catastrophic Events on Transportation System Management and Operations. Final Report DOT-VNTSC-FHWA-04-04*. Cambridge, MA: U.S. Department of Transportation John A. Volpe National Transportation Systems Center.
2. Andersson G., P. Donalek, R. Farmer, N. Hatzargyriou, I. Kamwa, P. Kundur, N. Martins, J. Paserba, P. Pourbeik, J. Sanchez-Gasca, R. Schulz, A. Stankovic, C. Taylor, V. Vittal. 2005. "Causes of the 2003 major grid blackouts in North America and Europe, and recommended means to improve system dynamic performance." *IEEE Transactions on Power Systems* 20: 1922-1928.
3. Corsi S., C. Sabelli. 2004. "General blackout in Italy Sunday September 28, 2003, h. 03:28:00." *IEEE Power Engineering Society General Meeting 1 & 2*: 1691-1702.
4. CNN Money. Available at: <http://money.cnn.com/2012/08/08/news/economy/blackout-india/>
5. EN 50160:2010: *Voltage Characteristics of Electricity Supplied by Public Electricity Networks*.
6. UCTE. 2004. *Final Report of the Investigation Committee on the 28 September 2003 Blackout in Italy, UCTE – Report*. 2004. Available at: [http://www.rae.gr/old/cases/C13/italy/UCTE\\_rept.pdf](http://www.rae.gr/old/cases/C13/italy/UCTE_rept.pdf).
7. U.S.-Canada Power System Outage Task Force. 2004, *Final Report on the August 14, 2003 Blackout in the United States and Canada: Causes and Recommendations*. Available at: <http://energy.gov/sites/prod/files/oeprod/DocumentsandMedia/BlackoutFinal-Web.pdf>.
8. Daily News. Available at: <http://www.nydailynews.com/new-york/northeast-blackout-2003-back-10-years-gallery1.1426456?pmSlide=1.1426535>.
9. Kusminska-Fijalkowska A., Z. Lukasik. 2015. "Information and communication technologies in the area with a complex spatial structure." In: Adam Weintrit, Tomasz Neumann, eds., *Information Communication and Environment. Marine Navigation and Safety of Sea Transportation*: 131-134. Boca Raton, FA: CRC Press/Taylor & Francis Group.
10. Nowakowski W., Z. Łukasik, P. Bojarczak. 2016. "Technical safety in the process of globalization." In: *16th International Scientific Conference on Globalization and its Socio-economic Consequences. Rajcke Teplice, Slovakia. Proceedings*. Part IV: 1571-1578.
11. PN-EN 50160:2014: *Parametry Napięcia Zasilającego w Publicznych Sieciach Elektroenergetycznych*. Warszawa: Polski Komitet Normalizacyjny. [In Polish: PN-EN 50160:2014 *Parameters of the Supply Voltage Within Public Power Networks*. Warsaw: Polish Committee of Standardization.]
12. PSE-Operator S.A., ENEA Operator. 2008. *Protocol Study Committee on Power Failures in the Szczecin Metropolitan Area on 7-8 April 2008*. Warsaw: PSE-Operator S.A., ENEA Operator.
13. Rozporządzenie Ministra Gospodarki z dnia 4 maja 2007 r. w sprawie szczegółowych warunków funkcjonowania systemu elektroenergetycznego (Dz. U. Nr 93, poz. 623). 2007. [In Polish: Ordinance of the Minister of Economy of 4 May 2007 on detailed conditions for the functioning of the power system.]

14. Zeng Boa, Ouyang Shaojie, Zhang Jianhua, Shi Huib, Wu Geng, Zeng Ming. 2015. "An analysis of previous blackouts in the world: lessons for China's power industry." *Renewable and Sustainable Energy Reviews* 42: 1151-1163.
15. Ittmann Hans W. 2017. "Private-public partnerships: a mechanism for freight transport infrastructure delivery?" *Journal of Transport and Supply Chain Management* 11: 1-13. DOI: <http://doi.org/10.4102/jtscm.v11i0.262>. ISSN 2310-8789.
16. Saruchera Fanny. 2017. "Rail freight transportation concerns of developing economies: a Namibian perspective." *Journal of Transport and Supply Chain Management* 11: 1-9. DOI: <http://doi.org/10.4102/jtscm.v11i0.288>. ISSN 2310-8789.
17. Lentink Ramon M., Dick Middelkoop, Douwe de Vries. 2017. "A comparison of different configurations of a centrally guided train operation system in Dutch railway operations." *Public Transport* 9(1-2): 155-176. ISSN 1866-749X.

Received 12.04.2017; accepted in revised form 19.07.2017



Scientific Journal of Silesian University of Technology. Series Transport is licensed under a Creative Commons Attribution 4.0 International License