

M. PRAŻMOWSKI*

MECHANICAL PROPERTIES OF ZIRCONIUM/STEEL BIMETAL FABRICATED BY MEANS OF EXPLOSIVE WELDING AT VARIED DETONATION VELOCITIES

WŁASNOŚCI MECHANICZNE BIMETALU CYRKON/STAL WYKONANEGO TECHNOLOGIĄ ZGRZEWANIA WYBUCHOWEGO PRZY RÓŻNYCH PRĘDKOŚCIACH DETONACJI

This paper assesses the effect of various values of detonation velocity on the quality of the bond zone, and thus the properties of bimetal zirconium (Zr 700) – steel (P355NL). The research was carried out for as-bonded welds, i.e. immediately following explosion welding. The results of shearing, peeling and tensile tests as well as macro-scale structural analyses were presented. In order to determine the changes in the value of strain hardening, the microhardness measurements across the interface were carried out. Based on the performed analyses it can be claimed that, depending on the applied technological settings of welding, most cases displayed wavy bond with highly diversified parameters of the wave. The changes observed with the detonation velocity are non-monotonic. High detonation velocities favored the formation of waves with large height and length and strongly affect the increase of the volume of brittle melted zones. Increased volume of the melted regions results in strong decrease of strength properties of the clad. The analysis of strength test results allows claiming that a small volume of melted regions in the bond considerably improves the strength of the bond.

As a result of explosion welding, strain hardening of the joined materials occurs near the interface. In the case of clad fabricated using high technological parameters the increase of strengthening and the depth of its influence in the interface area is observed.

Keywords: explosive welding, Zr/carbon steel clad, hardening, melted zone, intermetallic phases

W pracy poddano ocenie wpływ zróżnicowanych wartości prędkości detonacji na jakość strefy połączenia, a tym samym własności bimetalu w układzie cyrkon (Zr 700) – stal (P355NL). Badania prowadzono dla złączy w stanie wyjściowym, tj. bezpośrednio po zgrzewaniu wybuchowym. Przedstawiono wyniki badań mechanicznych (próba ścinania, zginania bocznego, odrywania oraz rozciągania) oraz strukturalnych w skali makro. Obserwacje strukturalne w pobliżu strefy połączenia umożliwiły określenie charakterystyki granicy połączenia. W celu określenia zmian w wielkości umocnienia wykonano pomiary mikrotwardości w obszarze złącza, jak i warstwy nakładanej oraz podstawowej.

W zależności od zastosowanych parametrów technologicznych procesu spajania uzyskano połączenie faliste o silnie zróżnicowanych parametrach fali. Zmiany obserwowane wraz ze wzrostem prędkości detonacji są niemonotoniczne. Duże prędkości detonacji sprzyjały tworzeniu się fali o dużej wysokości i długości oraz wyraźnemu wzrostowi udziału twardych i kruchych obszarów przetopień w strefie połączenia. Zwiększony udział obszarów przetopień powodował drastyczny spadek własności wytrzymałościowych platerów. Układy o optymalnej charakterystyce granicy połączenia oraz odpowiednio wysokich własnościach wytrzymałościowych otrzymano przy niskich wartościach prędkości detonacji. W wyniku procesu spajania następowało umocnienie obydwu łączonych materiałów w pobliżu granicy rozdziału.

1. Introduction

Reactive metals like titanium, zirconium, niobium and tantalum are being more and more widely applied in building process apparatus - in chemical and power industry. It follows from their high resistance to corrosion in various environments. Zirconium and its alloys are metals with a very low factor of hot neutron absorption which explains their common use in the construction of some nuclear reactors' elements. Moreover zirconium is a metal with the highest reflection of electromagnetic radiation coefficient therefore Zr sheets are used as indoor protection against radiation. Taking into con-

sideration the high cost of these materials and the fact that just a thin layer provides appropriate protection, it can be used in many application as clad materials (most often two-layered). Such bimetal perfectly meet requirements concerning strength properties, chemical, physical, etc.

Despite the fact that explosion welding has been in place for many years, still many associated physicochemical phenomena is unidentified. It results from specific conditions of the process such as: high speed of deformation (1600 – 2700m/s), pressure at contact point up to a few GPa, collision velocities up to a few hundred m/s. The right choice of these parameters ensures obtaining a bond with the right geometry

* OPOLE UNIVERSITY OF TECHNOLOGY, FACULTY OF MECHANICS, 5 MIKOŁAJCZYKA STR., 46-020 OPOLE, POLAND

and morphology and determines the right strength properties. The literature of the field offers publications regarding multiple aspects of joining various combinations of metals, i.e. [1,2]. However, when it comes to welding Zr (and its alloys) with other metals, the literary data are rather sparse; the few published papers regards mainly a numerical analysis of the process, e.g. [3].

Optimal bonding parameters, affecting equally the quality of the bond and mechanical properties of the resulting clad, must be correctly selected at the stage of designing the blast arrangement. Explosion welding parameters include the quality and quantity of the explosive material, the method of detonation initiation, and the geometry of the welding structure as well as mechanical and physical properties of the joined metals. The phenomenon that determines the joining of materials during explosion welding is the collision of the flyer plate with the base plate. Key parameters which are decisive for obtaining a 'proper' bond during explosion welding are the collision point speed v_C and the impact angle of sheets β . They are strongly dependent on the detonation velocity of the explosive (v_D) and the stand-off distance between the sheets (h) [1-3]. The collision velocity may be adjusted by selecting respectively the detonation energy and detonation velocity of the explosive charge; both parameters strongly dependent on the type and quantity of the explosive material [5,6].

This paper undertakes to analyse changes in a broadly termed bond zone in test plates of zirconium (flyer plate) and carbon steel (base plate) joined by explosion welding with variable detonation velocity and it also deals with the effect of these changes on macroscopic mechanical properties of the clad.

2. Research techniques

2.1. Research material

Research presented in this work was carried out on bimetal plates produced by explosion welding by EXPLOMET High-Energy Techniques Works in Opole. Explosion bonding was performed in a parallel arrangement where the base material was a sheet of carbon steel (thickness of 20 mm) designed for operation in elevated temperatures whereas the deposited material (flyer plate) was a sheet of Zr700 alloy (thickness of 3.175 mm). The chemical composition of both materials was shown in Table 1 and 2, whereas their initial mechanical properties were collected in Table 3.

TABLE 2

The chemical composition of zirconium sheets, as per the supplier's certificate

Basic Material	Chemical composition [%]						
	C	FeCr	H	Hf	N	O	Zr+Hf
Zr 700	<0.002	0.05	<0.0003	0.4	<0.002	0.05	>99.2

TABLE 3

Mechanical properties of materials before cladding

Materials	R_m (MPa)	$R_{0.2}$ (MPa)	A (%)
Zr 700	280	143	35
P355LN	551	402	26.7

Figure 1a shows the structure of Zr700 sheet in as-is state, i.e. before bonding in section perpendicular to lateral direction (KP). It is evident that the material is characterized by the structure of α phase grains of size ranged between 70 μm and 170 μm . Figure 1b presents the P355NL carbon steel microstructure in as-is state characterized by an equiaxed structure of middle-sized grains in the range of 4 to 11 μm for pearlite and 10-20 μm for ferrite. For pearlite, we can see a band structure of fine grains, typical for materials that underwent hot forming.

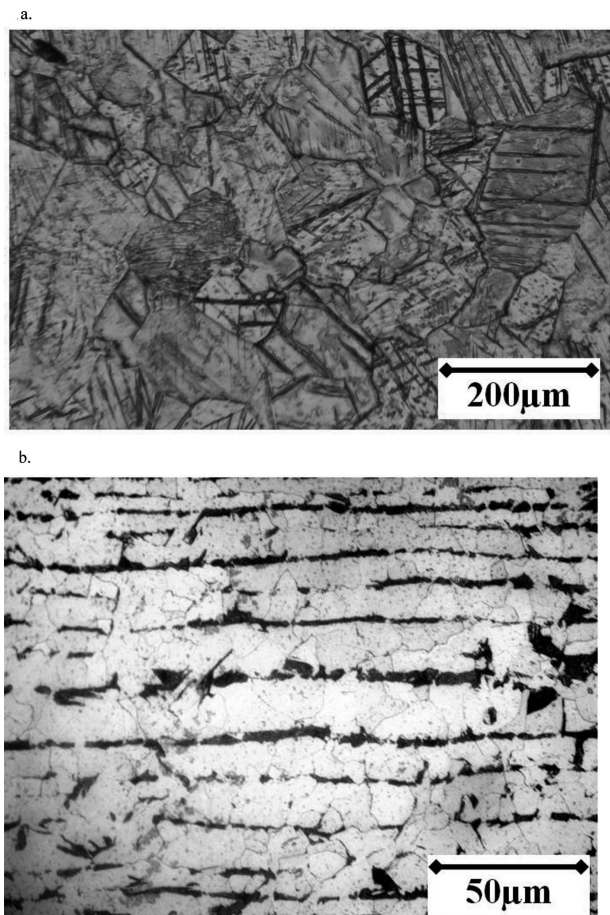

Fig. 1. The initial microstructure of (a) Zr700 – polarized light image, (b) steel P355NL

TABLE 1

The chemical composition of steel sheets, as per the supplier's certificate

Basic Material	Chemical composition (%)						
	C	Mn	Si	P	S	Cr	Cu
P355LN	0.170	1.130	0.345	0.008	0.001	0.150	0.170
	Ni	Mo	Al	N	Nb	Ti	Fe
	0.285	0.035	0.045	0.004	0.019	0.005	rest

Bimetals were produced with a combination of ammonite group explosive charges with a diverse explosion energy, which allowed obtaining 3 different detonation velocities and bimetals with different characteristics of the bonds zone as a result, Figs. 2a-c.

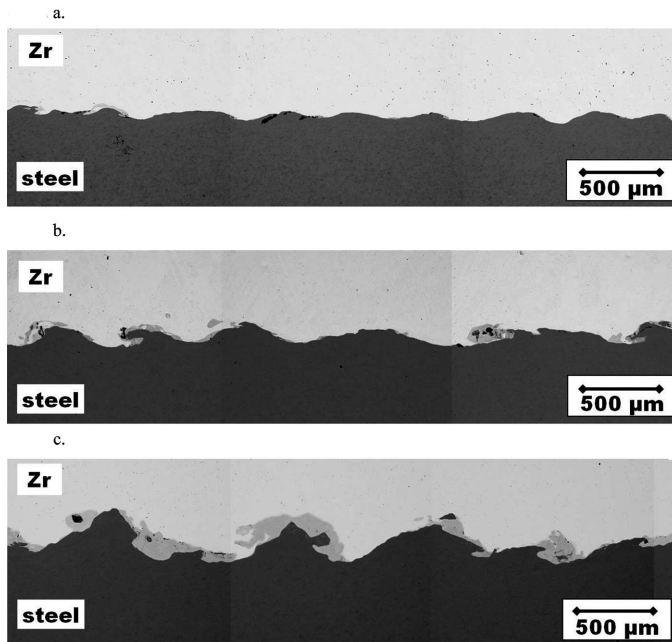

Fig. 2. The influence of detonation velocity on changes near the interface: (a) $1.0v_D$, (b) $1.1v_D$, (c) $1.3v_D$

In all cases a constant stand-off distance between the joined plates similar to the thickness of deposited sheet was applied ($h=3$ mm). The designation of the analysed plates and the relations between process parameters were presented in Table 4. The obtained testing plates with dimension of $235\text{ mm}\times 455\text{ mm}$ were subjected to mechanical examinations and metallographic analysis.

TABLE 4
Designation of the produced plates and the relations between process parameters

Plate	Detonation velocity v_D [m/s]	Stand off distance h [mm]
$1.0v_D$	2200	3.0
$1.1v_D$	2500	3.0
$1.3v_D$	2800	3.0

2.2. Mechanical properties and the 'quality of the bond'

The qualitative assessment was performed using non-destructive and mechanical methods in accordance with the current standards. Ultrasonic test enabled to examine the continuity of the weld whereas the assessment of mechanical and technological properties was based on shearing, peeling, tensile tests and lateral bending. Ultrasonic tests were performed on the bimetal's surface on the side of the deposited material using Starman's DiO 652LC ultrasonic flaw detector. The marked discontinuities were presented in Fig. 3 and the results obtained were collected in Table 5.

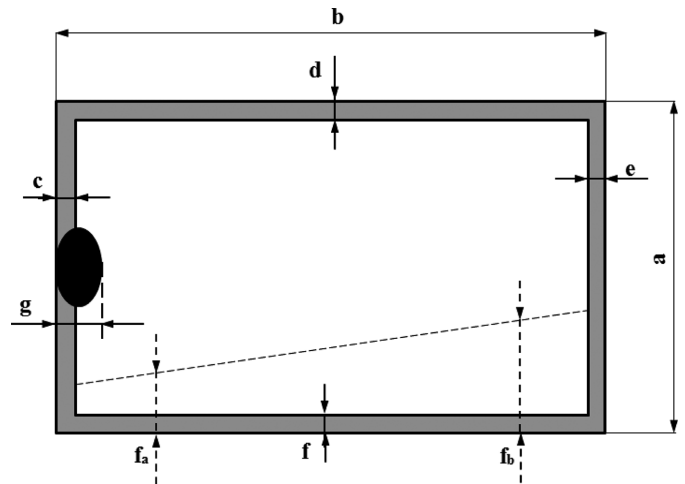

Fig. 3. Marking of discontinuity regions in the tested clad: grey area (c, d, e, f) the region of so called working margin, g – discontinuity region linked to the initiation point, f_a and f_b – discontinuities in the 'correct' joint area

TABLE 5
Parameters and ultrasonic test results of the joint continuity

Plate	Plate size [mm]		Discontinuity size [mm]				
	g_1+g_2	$a\times b$	C	d	e	f	G
$1.0v_D$	20+3.175	235×445	30	90	40	50	35
$1.1v_D$	20+3.175	235×445	15	15	15	20	40
$1.3v_D$	20+3.175	235×445	20	25	15	20	30

The first trial of the joint interface was a lateral bending test. Flat specimens of 10×23.2 mm cross-section and the length of 200 mm sampled perpendicular to the detonation wave propagation were selected for the tests. The specimens were bent by 180° on a $d=40$ mm diameter rod.

Since the bending test may be faulty in many instances due to the wavy nature of the bond, peeling test was additionally carried out to evaluate resistance to splitting (and Ro value determination). The diagram of the performed peeling tests was presented in Fig. 4a.

The assessment of the joint strength was performed based on shearing test. The specimens were sampled from the clad in such a way that the shearing plane was parallel to the direction of the detonation propagation wave. The shape and dimensions of the specimens were given in Fig. 4b. The shearing and peeling trials were performed until the total separation of the material occurred, recording the maximum force needed for the separation to happen.

For peeling and shearing, the spot of the sample destruction was macroscopically observed. For strong bimetals, the characteristic place of destruction is the area in the deposited or base material (typically the weaker one). The destruction of the specimen at the joint interface indicates poor strength properties of the analysed clad.

Within the research tests, tensile strength (R_m) was analysed based on tensile tests of the specimens with shapes and dimensions presented in Fig. 4c. Specimens with $23.2\times 10\text{ mm}\times 2\text{ mm}$ dimensions were sampled. (Fig. 4c). The necking down of the specimen was done by means of a cylindrical

cutter with a diameter of $\Phi = 3$ mm and the corner radius $R=0.5$ mm.

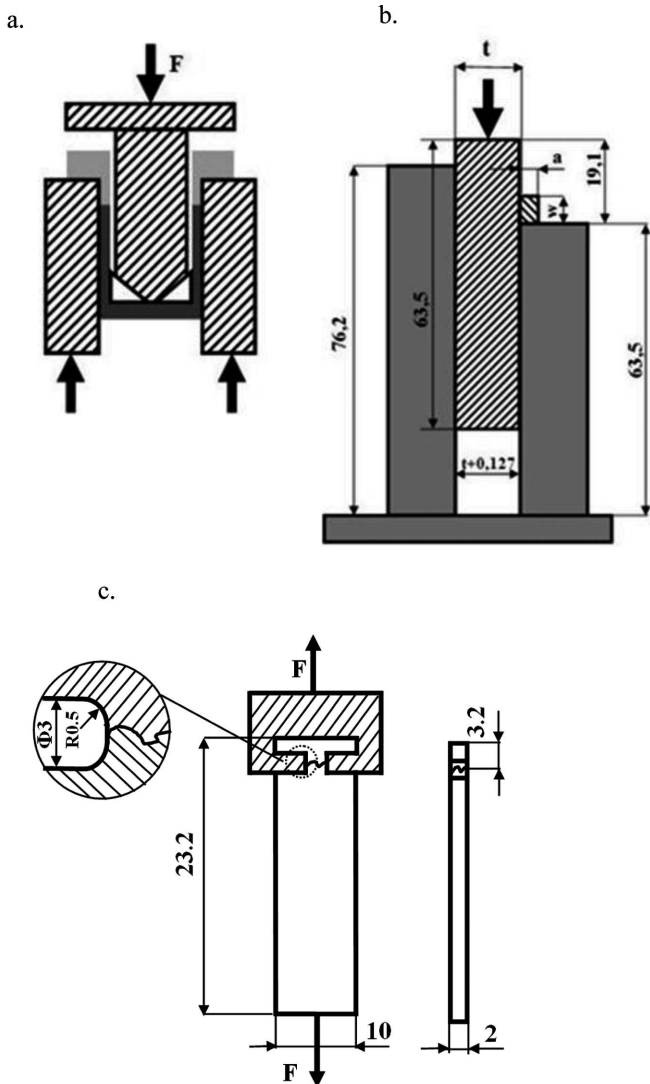

Fig. 4. Mechanical properties tests. Shape and dimensions of the sample for: a) peel test, b) shearing test, c) tensile strength test

2.3. Macroscopic analysis of the interface bond – optical microscopy

The microscopic specimens were sampled from the as-is sheets and welded bimetals. In the case of clads the polished specimens were produced as sections perpendicular to sheet surface and parallel to the detonation front motion. The metallographic specimens were made through mechanical grinding and polishing (abrasive papers and diamond pastes with descending grade), and then polishing and etching with LectroPol 5 polisher using Struers™A3 electrolyte.

By means of LECO IA 32 image analysis system a macro-analysis of the prepared specimens was made for the purpose of the general description of the bond and the quantitative calculation of the fraction of the melt layer. In order to determine the interface of the joined plates, measurements were made of the length of the bond line (L), height (H) and wave length (n) as well as the area of the melt surface P (Fig. 5). Based on average values of the above parameters, equation 1 was

used to determine RGP coefficient describing the melt depth equivalent:

$$RGP = \frac{S}{L} \quad [\mu m] \quad (1)$$

where: S – the sum of P_i surface of fusion regions in μm^2
 L – the length of the bond line μm .

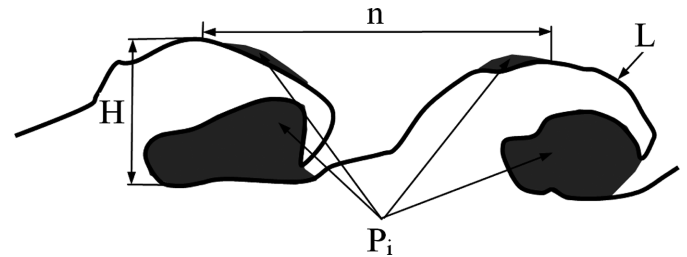

Fig. 5. Basic bond parameters: H – height of the wave, L – length of the bond line, n – wave length, P – 'fusion' surface area

2.4. Microhardness measurements

Changes in the strength close to the weld zone, in the longitudinal section of the joined sheets, were analysed by microhardness measurement by Vickers method using LECO MHT Series 200 microhardness tester under the load of 50G. The measurements were performed along the line perpendicular to the interface (3 series). Impresses were made from the joint interface, outside melt regions, locating the first measurement at 0.02 mm from the bottom of the wave for each of the materials in the bimetal. The results presented in the paper are a mean value of three parallel measurements. The obtained average results for the tested bimetals were compared to the hardness of the input material as shipped (prior welding).

3. Results and discussion

3.1. Structural observations

The analysis of the bond zone was carried out by means of scanning electron microscopy on the longitudinal section (in the direction of detonation front movement). Based on the performed measurements of the wave settings (Fig. 3) and microstructural analysis of the bond zone (Fig. 2a-c) it can be concluded that a wavy bond was obtained in all three cases.

On the basis of the performed observations it can be concluded that the detonation velocity strongly influences bond-defining parameters. In the case of a specimen made with a lower detonation velocity ($1.0v_D$) the wave height is $64 \mu m$, whereas a 10% increase in the detonation velocity ($1.1v_D$) caused the increase in the wave height by 80% ($H=122 \mu m$) compared to the specimen with lowest speed. An even greater increase in the wave height was observed for the specimen with the greatest detonation velocity ($1.3v_D$), where a 3.5-fold wave height increase occurred ($H=234 \mu m$) compared to the height obtained at the lowest detonation velocity (Fig. 6). An analogous situation could be observed analysing the wave length. For the bimetal with a medium detonation velocity ($1.1v_D$) the length of the wave increased slightly by about 20% ($n=468 \mu m$) compared to the wave length obtained with

the lowest detonation velocity ($1.0v_D$), which reached $n=468 \mu\text{m}$. For the specimen made at $1.3v_D$ detonation velocity an 80% increase of the wave length occurred ($n=881 \mu\text{m}$) compared to $1.0v_D$ specimen – Fig. 6. The same Figure analyses the effect of the applied detonation velocities on the intensity of the melt layer occurrence. It was noticed that the increase in the detonation velocity caused the surge of the melted layer fraction in the bond, and the rise in the 'RGP' factor (melt depth equivalent). Its highest value – $21 \mu\text{m}$ was received for the bimetal with the highest detonation velocity ($1.3v_D$), whereas the lowest of $5 \mu\text{m}$ for a bimetal of the lowest detonation velocity ($1.0v_D$). For $1.1v_D$ detonation velocity, the fraction of the melt layer was $\text{RGP}=12 \mu\text{m}$.

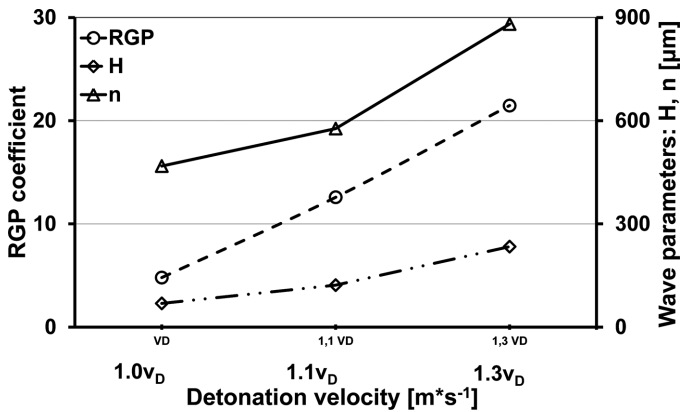

Fig. 6. Parameters describing wave shape and the quantity of the melted zone

The analysis of the melt layer ratio based on the melt depth equivalent changes RGP (Fig. 6) allows determining a linear increase of the melt layer in the joint as the detonation velocity increases.

3.2. Mechanical tests

All the specimens in lateral bending were bent by 180° angle and no cracks or splitting was noticed.

The average values of parameters resulting from strength tests were presented in Fig. 7. The highest values of shear strength R_s was received from bimetals of low detonation velocities. For $1.0v_D$ specimen the value was $R_s = 369 \text{ MPa}$, whereas for $1.1v_D$ it was $R_s = 395 \text{ MPa}$. The rise in the detonation velocity up to the maximum value of $1.3v_D$ caused about 40% drop in strength ($R_s = 247 \text{ MPa}$) as compared to the highest value obtained. During the peel test the value of R_o was noticed to decrease along with the increase of the detonation velocity.

The highest R_o value of 376 MPa was obtained for specimens welded using the lowest detonation velocity ($1.0v_D$) – Fig. 7. Increasing the detonation velocity by 10% ($1.1v_D$) and 30% ($1.3v_D$) caused a 30% (down to 278 MPa) and 60% (down to 160 MPa) drop in peeling strength as compared to the maximum result obtained.

The tensile strength test R_m proved, similarly to shearing test, high values of samples made at the detonation velocity of $1.0v_D$ and $1.1v_D$, which were at a similar level of 495 MPa and 465 MPa respectively. In the case of the highest detonation velocity of $1.3v_D$ the tensile strength R_m fell 2.5-fold and

reached 198 MPa . Worsening the strength properties can be connected to the above-mentioned phenomenon of the formation of hard and brittle melted layers at the bond interface. As can be noted in Fig. 7, the largest fraction of the melted layer ($\text{RGP}=21.5 \mu\text{m}$) was recorded for the $1.3v_D$ specimen which had the worst results in the performed strength tests. Very high strength properties were obtained for the specimen with the lowest detonation velocity $1.0v_D$ and very little participation of the melt layer in the bond ($\text{RGP}<5$).

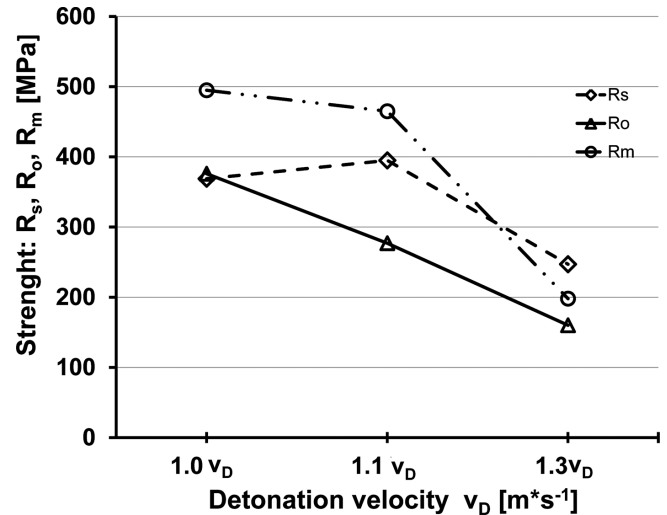

Fig. 7. The strength properties of bimetal Zr700/P355NL

3.3. Microhardness measurements

Changes in the distribution of hardening were analysed through microhardness measurement in the bond zone in the section perpendicular to the joint surface and parallel to the propagation of the detonation front. The measurements were recorded on the entire section of the clad, along the "scan lines" perpendicular to the surface of the bond. Microhardness changes were compared to the measured average value of microhardness of steel and zirconium before the explosion (horizontal line in Fig. 8). An analysis of the effect of the detonation velocity on the hardening 'penetration depth' was performed through the measurement of microhardness on the entire section of the joined plates (Fig. 8a).

In all of the analysed cases it can be concluded that, the highest hardening, both on the side of the base and flyer plate occurs in the direct vicinity (around 0.02 mm) of the joint interface. The measurements of the zirconium plate showed that for the $1.0v_D$ specimen at 0.5 mm from the joint interface the hardness reaches values similar to the average microhardness of Zr in the initial state. Higher detonation velocities ($1.1v_D$ and $1.3v_D$) caused a rise in microhardness at a much greater distance from the bond surface. In this case the microhardness in zirconium reached values characteristic for the material in initial state only at about 2.5 mm from the interface, Fig. 8a. In the case of steel we observe both the deeper penetration of the hardening and a greater impact of the detonation velocity on the microhardness values in respective layers. The pattern of changes for all specimens is similar, whereas there is a pronounced tendency of hardening rise for higher detonation velocities. In all cases, there is a 15% fall of hardness at the distance of about 0.1 mm from the bond interface. From that

point up to about 2.5 mm from the bond interface a systematic decrease of microhardness with a similar course can be observed. From that point a mild decrease of microhardness down to values close to base material's values prior to welding. Despite a similar pattern of hardness curves for all three analysed cases, a correlation between the hardening and the detonation velocity can be clearly noticed. It manifests itself in shifting the curves describing the progression of hardness towards higher values for greater detonation velocities (Fig. 8a).

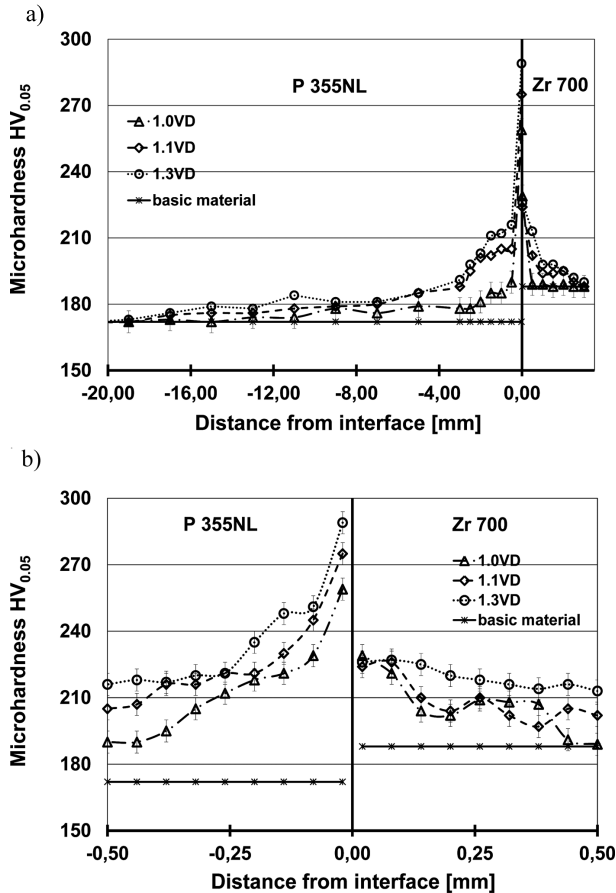

Fig. 8. Microhardness changes for different detonation velocities, along the 'scan lines' a) through the whole section of the joined plates, b) through bond zone (starting 0.5 mm from the joint interface)

The analysis of hardening in the area directly adjacent to the joint interface (up to 0.5 mm) proved that for zirconium plate (micro)hardness near the surface of the bond increased relatively mildly as compared to the initial state material (Fig. 8b). The greatest increase of hardness (about 20%) was observed directly near the joint interface for all analysed cases. The hardening remained constant throughout the whole area only for the 1.3v_D specimen. In the other two cases (1.0v_D and 1.1v_D) the hardening decreased systematically and at about 0.5 mm from the interface it reached the hardness of the deposited material (Zr) in initial state for the 1.0v_D specimen. Significantly larger changes were observed in the bond zone of the base material i.e. steel where the hardening rose markedly along with the increase in the detonation velocity. For the specimen welded with the lowest detonation velocity (1.0v_D),

the microhardness measured in the direct vicinity of the joint interface increased by about 50% as compared to the initial state material and by 70% for the bimetal welded with the highest detonation velocity (1.3v_D).

4. Conclusions

The present study analyses the effect of the detonation velocity (v_D) during explosion welding on the properties of the obtained clad Zr700/P355NL. The performed research allowed the formation of the following conclusions:

- The mechanical properties of the fabricated bimetals i.e. shear strength, peel strength and tensile strength strongly depend on the process settings (stand-off distance between plates and the detonation velocity); their values rise with the increase of the detonation velocity.
- Characteristic bond zone parameters, in particular the amount of melt in the bond, are determined by the selection of the process settings; for a given stand-off distance, increasing the detonation velocity causes the increase of the 'RGP' factor, i.e. the extension of the melt volume in the bond zone occurs.
- However, the increase of the melted layer in the bond zone adversely affect the strength properties of the bimetal.

As a result of explosion welding, hardening of the joined materials occur near the interface. Nevertheless, it is more pronounced in steel and less in Zr. The volume of the hardened area heavily depend on the detonation velocity. The greatest hardening both in the steel plate and Zr occurs in the areas adjacent to the boundary.

Acknowledgements

The research study was financed from the state funds for science in 2010-2013 as a research project no NN507 457839.

REFERENCES

- [1] W. Walczak, Zgrzewanie wybuchowe metali i jego zastosowanie, Warszawa 1989, WNT (in polish).
- [2] Explosive welding, forming and compaction, edited by Blazynski T.Z., Applied Science Publishers, London and New York.
- [3] M. Mazar A t a b a k i, Microstructural evolution in the partial transient liquid phase diffusion bonding of Zircalloy-4 to stainless steel 321 using active titanium filler metal, Journal of Nuclear Materials **406**, 330-344 (2010).
- [4] H. D y j a, A. M a r a n d a, R. T r e b i n s k i, Technologie wybuchowe w inzynierii materialowej, Czestochowa 2001, Wydawnictwo Wydziału Metalurgii i Inzynierii Materialowej Politechniki Czestochowskiej (in polish).
- [5] H. P a u l, M. F a r y n a, M. P r a z m o w s k i, R. B a n s k i, Changes in the bonding zone of explosively welded sheets, Archives of Metallurgy and Materials **56**, 443-474 (2011).
- [6] M. P r a z m o w s k i, H. P a u l, The effect of stand-off distance on the structure and properties of zirconium – carbon steel bimetal produced by explosion welding, Archives of Metallurgy and Materials **57**, 4, 1201-1210.