

DEVELOPMENT OF SHEAR CONNECTIONS IN STEEL- CONCRETE COMPOSITE STRUCTURES

Antoni BIEGUS¹, Wojciech LORENC
Wrocław University of Technology, Poland

Abstract

Different types of shear connectors and modelling techniques are presented. Basic research conducted or presented after year 2000 is taken into consideration, following the idea of concrete dowel implemented in the form of perfobond strip at the beginning of the 1980s by F. Leonhardt. The latest research in the field of continuous shear connectors applied in bridges is highlighted with special focus at the composite dowel shear connection, as it seems to be the most modern solution being strongly introduced to the industry. Final shape of composite dowel shear connection is presented.

Keywords: shear connection, composite beam, composite dowels

1. INTRODUCTION

Not all of existing shear connectors can be used in building as well as in bridges. The important factor is that because of fatigue problems some structural solutions applied in buildings are not to be used for bridges. Continuous shear connectors are rather inadequate for applicable to buildings if profiled steel sheeting is used. Some kinds of discrete connectors are not to be used in bridges because of aspects of behaviour under cyclic loads, especially solutions for composite slabs based on nails coming through steel profiled sheeting [16, 10] that are simple and economic solutions in buildings (figure 1).

¹ Corresponding author: Wrocław University of Technology, Faculty of Civil Engineering, Wybrzeże Wyspiańskiego 27, 50-377 Wrocław, Poland, e-mail: antoni.biegus@pwr.edu.pl, tel.+48713203766

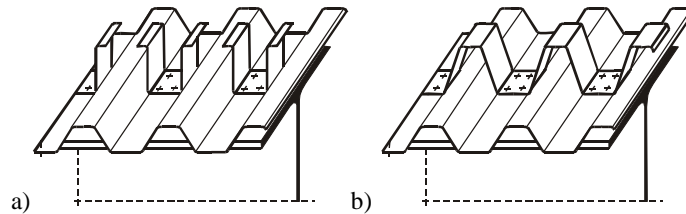

Fig. 1. Proposals for shear connections using: a) hat profile [16], b) corrugated strip [10]

Different types of shear connectors are presented in figure 2. Welded studs and screws (figure 2d) are of course universal solutions. Screws are mainly used for strengthening of existing structures if problem arises with welding to existing steel elements. Future solutions for bridges are rather expected to be based on the idea of a continuous shear connection and the latest research programs [21, 19] confirm this direction of development.

2. TYPES OF SHEAR CONNECTORS AND MODELLING ASPECTS

2.1. Shear connectors in bridges: from perfobond strip to composite dowels

The latest research in the field of continuous shear connectors applied in bridges is shortly presented, with special focus at the composite dowel shear connection, as it seems to be the most modern solution being strongly introduced to the industry. Basically research conducted or presented after year 2000 is taken into consideration, following the idea of concrete dowel (implemented in the form of perfobond strip at the beginning of the 1980s by F. Leonhardt [11]) with work completed by Wurzer [22] at the Munich University of Technology assumed as a initial point for following study.

After year 2000 concrete dowels were studied by different researchers [15, 8, 23, 4, 9] but no spread industrial applications were rather achieved. The important step in the development of concrete dowels was made by Zapfe [24], who continued investigations started by Wurzer [22], as he established three fundamental concrete failure mechanisms for concrete dowels (concrete crushing by local compression, pry-out of concrete coverage by a cone, concrete failure by shearing) and gave empirical formulas for calculations.

Different approach is presented in [6]; it is assumed that the resistance of concrete dowels is established by sum of two factors: the resistance of concrete (failure by shearing) and cohesion between concrete and steel elements (plate with dowels and upper flange). The steel failure was considered also during

research programs concerned with the implementation of high strength materials at RWTH Aachen [21]. Simple formulae for the resistance were presented and fatigue problems in steel dowels during testing of innovative puzzle shaped concrete dowels became visible and studied - it was also noticed earlier during cyclic tests [24]. In the middle of the year 2006, an international research project PreCo-Beam [19] financed by Research Fund for Coal and Steel started; the work conducted can be found reported in [1, 18, 12]. During this project, the development of fatigue resistant shape and theoretical background supported by advanced FE approaches and testing programs at universities in Munich, Liege and Wrocław were achieved; both steel and concrete design formulas based on mechanical models were established.

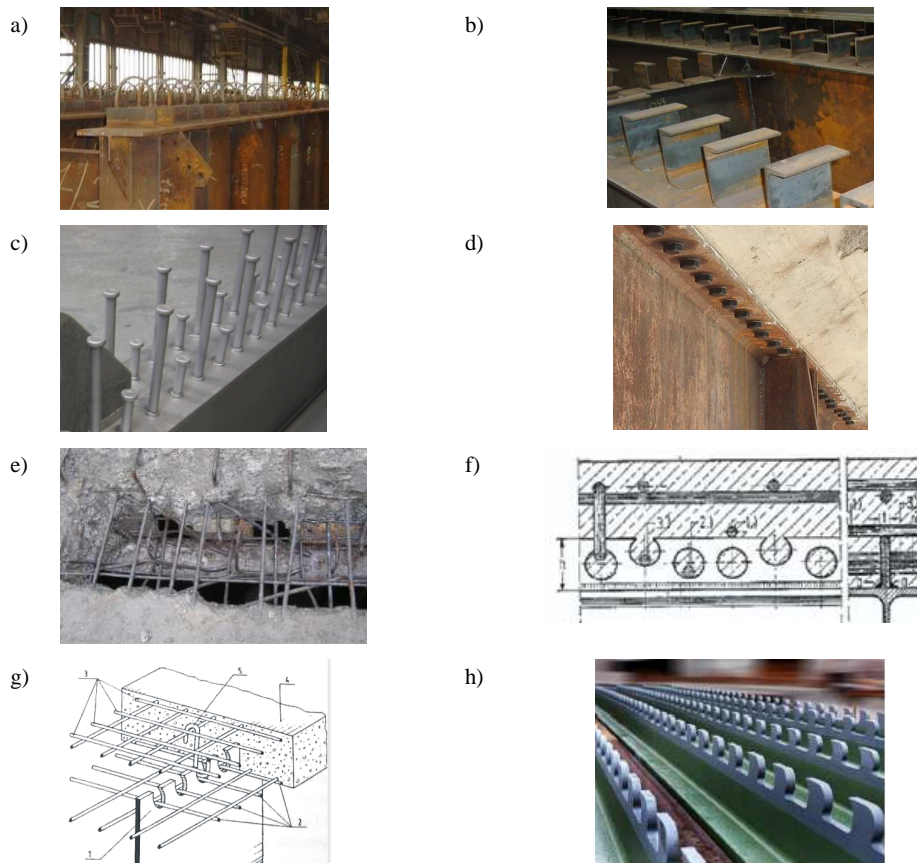

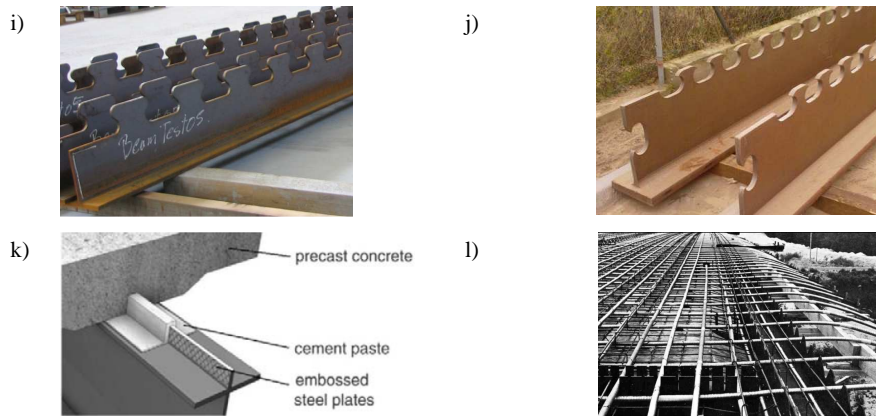

Fig. 2. Different types of shear connectors: a,b) block connectors, c) welded studs, d) screws, e) welded bars, f) perfobond strip (concrete dowels) [11], g) kombi (concrete dowels) [22], h) shark fin shape (composite dowels) [19], i) puzzle shape (composite dowels) [19], j) final CL shape (composite dowels), k) shear connection based on friction [20], l) shear connection based on friction by prestressed cables [7]

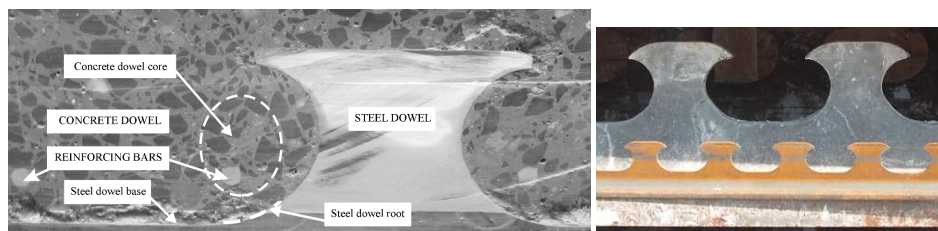

Fig. 3. Composite dowel shear connection: nomenclature and its final shape

The terminology “composite dowels” was proposed for the new shear connection as it was proved that both steel and concrete failure mechanisms govern the behaviour of this kind of shear connection. Hence composite dowel shear connection is combined out of a steel dowel and a concrete dowel (figure 3). The basic issue is the determination of the state of stresses in steel dowels and it is especially important in fatigue analysis, hence appropriate shape of cutting line is crucial [1]. The surrounding concrete and reinforcing bars must ensure the confining effect for concrete dowels [18]. Efficient technology of fabrication with single cutting line [1] enables realization of robust and economic composite girders. Final shape used nowadays in composite bridges is presented in figure 3; different sizes of dowels are possible because, what is important, only shape is the factor in design of steel part of shear connection if shear resistance per unit length is considered [12]. The main question currently is the influence of friction between steel and concrete and how it can be

considered in design, one can find a connection to the solutions presented in figure 2 k, l.

2.2. Modelling aspects

Different approaches are used for modelling the shear connection behaviour and hence the behaviour of composite beams. The behaviour in local scale can be handled easily with FEM (figure 4) and global scale effects can be handled with strut-and-tie models, FEM or with prismatic beam approaches and appropriate displacement fields taking the weak shear connection into consideration (figure 5).

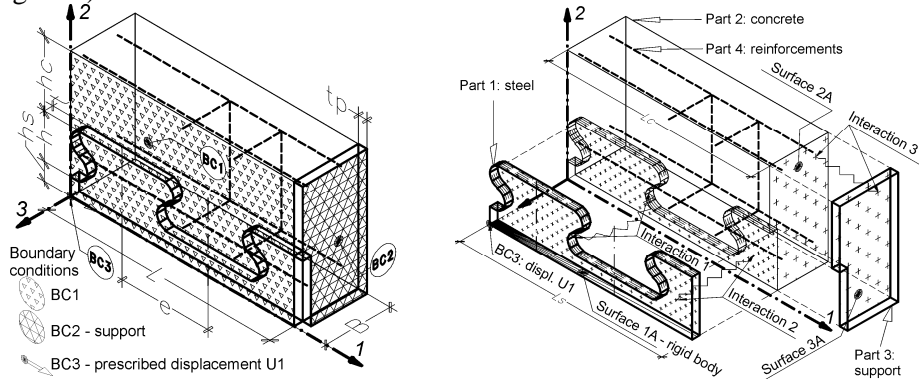

Fig. 4. Structure of simple FE model of shear connector (single connector embedded in concrete)

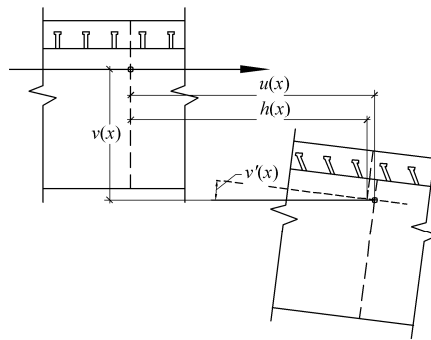

Fig. 5. Weak shear connection

The used approach depends on what is the aim of the study. Usually the aim is to study the behaviour of steel connectors in concrete in details in order to get particular nonlinear force-slip relationship at the end.

In general for beams in 2D space, the most common approach is to include a weak shear connection by introduction of third function next to those describing

horizontal and vertical displacements of the centroid of composite beam [2] (figure 6). In this way, the displacement field is described by means of three functions of displacements:

$u(x)$ - displacement of points of the composite beam in the horizontal direction, i.e. in x-direction (the composite beam axis consist of the points initially lying on the x-axis),

$h(x)$ - the relative due to slip: $u(x) - h(x)$

$v(x)$ - displacement of points of the composite beam in the vertical direction, i.e. in y-direction.

Such a displacement field provides only the axial strain in the steel beam and concrete slab, and the slip deformation component. The three functions enable modelling of the structure with nonlinear constitutive laws for steel, concrete and shear connection, as the nonlinear distribution of stud forces along the beam. The other solution is an approximation of displacements by assumed type of functions [13]. The method proposed is the Ritz method which, in approximation, consists of the solution with a finite set of shape functions selected from orthonormal base. It allows to analyse monosymmetrical beams in nonlinear range, both simply supported and continuous.

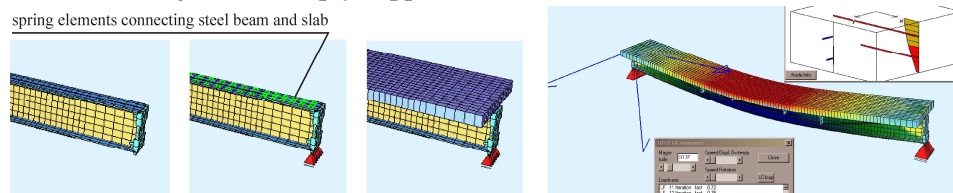

Fig. 6. Implementation of spring elements into finite element model

The other solutions are mainly based on the introduction of nonlinear spring elements and handling the problem by finite elements. It is presented in figure 6 how spring elements with nonlinear force-slip relationships are introduced to connect flange of steel beam and reinforced concrete slab (modelled by shell elements) in steel-concrete composite beam prestressed with external cables.

2.3. Studies of force-slip relationship

The force-slip relationship under monotonic load, which is the key point of study of composite structures, can be experimentally measured by push-out test, what is recognized as a simple procedure. Failure of steel connectors can be considered with the assumption of fully yielded section. Concrete failure can be based on strut-and-tie model which is possible to be established even in situations of its complex behaviour [17]. Extensive study concerning handling the concrete failure by mechanical models can be found in [18]. The most common solution for detailed studies is nowadays the FEM-based approach. An

example is presented in figure 7. It can be applied of course for different shear connectors, such as for studs in slabs with profiled steel sheeting [3] and for composite dowels [14]. Last decade research programs were conducted at different universities concerning numerical models of complicated structural solutions of shear connections. Very advanced approaches using ABAQUS software to be mentioned herein were conducted within independent research programs carried out by Wrocław University of Technology and Vienna University of Technology - results can be found in [4, 19, 1, 12, 14, 5].

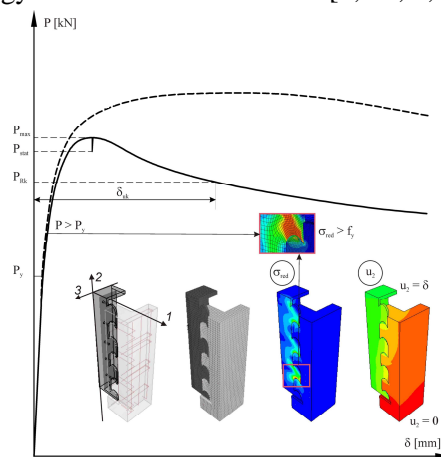

Fig. 7. Presentation of simulation by FE push-out test for composite dowels: dashed line represents situation with “infinitely strong concrete” and steel failure only, continuous line represents realistic situation with failure of steel and concrete, P_y represents level of force describing situation when first yielded point appears in steel dowels

3. CONCLUDING REMARKS

On the background of different types of shear connections presented, specific types of connectors to be used in buildings and bridges have been highlighted. As interesting development in the field of continuous shear connectors has been observed during the last decade, the different solutions have been proposed and research programs conducted, leading to the composite dowel shear connection which seems to be the most promising solution for the connections of this type for future. It is very important for design purposes, but not only, that under certain circumstances the resistance of steel dowels in composite dowel shear connections per meter does not depend on size of connectors, but on shape only, and ductility can be assumed as a linear function of the size of connectors.

REFERENCES

1. Barthelley J., Hechler O., Lorenc W., Seidl G., Viefhues E. : *Premiers résultats du projet de recherche européen Precobeam de connexion par découpe d'une tôle*, Construction métallique, CTICM, 46, 3 (2009) 3-26.
2. Dall'Asta A., Dezi L., Leoni G.: *Failure mechanisms of externally pre-stressed composite beams with partial shear connection*, Steel & Composite Structures 2, 2002, 315-330.
3. Ellobody E., Young B.: *Performance of shear connection in composite beams with profiled steel sheeting*. Journal of Constructional Steel Research 62, 2006, 682-694.
4. Fink J., Petraschek Th.: *Novel shear connectors experimental investigations and numerical comparisons*, in: R. Eligehausen, G. Genesio, W. Fuchs, P. Grosser (eds): Proceedings of the 2nd International Symposium on Connections between Steel and Concrete, ibidem-Verlag, ISBN-10:3-89821-807-4, Stuttgart 2007, 1327-1336.
5. Fink J., Petraschek Th., Ondris L.: *Push-Out Test Parametric Simulation Study of a New Sheet-Type Shear Connector*, in: Projekte an den zentralen Applikationsservern. Berichte 2006, Zentraler Informatikdienst (ZID) der Technischen Universität Wien, Wien 2007, 131-153.
6. Furtak K.: *Composite bridges*, PWN, [in Polish], Warszawa 1999.
7. Grelu H.: *Association dans les ponts de la précontrainte et de la charpente métallique*, Bulletin de liaison "ponts métallique", 6, 1975.
8. Hyeong-Yeol Kim, Youn-Ju Jeong: *Experimental investigation on behaviour of steel-concrete composite bridge decks with perfobond ribs*, Journal of Constructional Steel Research 62, 2006, 463-471.
9. Jurkiewicz B., Hottier J.M.: *Static behaviour of a steel-concrete composite beam with an innovative horizontal connection*. Journal of Constructional Steel Research 61, 2005, 1286-1300.
10. Kania P., Kucharczuk W.: *Shear connection of steel-concrete composite beam by nails*. Konstrukcje Stalowe, [in Polish], 6, 2007.
11. Leonhard F. et al., Neues, vorteilhaftes Verbundmittel für Stahlverbund-Tragwerke mit hoher Dauerfestigkeit.: *New advantageous shear connection for composite structures with high fatigue strength*, Beton- und Stahlbetonbau, Heft, 12, 1987.
12. Lorenc W.: *The design concept for the steel part of composite dowel shear connection in steel-concrete composite structures*, Wrocław University of Technology Publishing Office, [in Polish], Wrocław 2010.

13. Lorenc W., Kubica E.: *Nonlinear modelling of composite beams prestressed with external tendons*, Archives of Civil and Mechanical Engineering 4, 1, 2004, 83-93.
14. Lorenc W., Ignatowicz R., Kubica E., Seidl G.: *Numerical model of shear connection by concrete dowels*, Recent Developments in Structural Engineering Mechanics and Computation, Millpress, Rotterdam 2007.
15. Mareczek J., Chromiak P., Studnicka J.: *Numerical model of perforated shear connector*, Progress in Steel, Composite and Aluminium Structures - M.A. Gizejowski, A. Kozłowski, L. Ślęczka and J. Ziółko (eds), Taylor & Francis, ISBN-0-415-40120-8, London 2006.
16. Nawrot J., Kucharczuk W.: *Experimental tests on ultimate resistance of new shear connectors for steel-concrete composite slabs*, Inżynieria i Budownictwo, [in Polish], 12, 2004.
17. Petraschek T, Fink J.: *Shear force capacity of crown dowel*. Models for calculation. EUROSTEEL, Graz 2008.
18. Seidl G.: *Behaviour and load bearing capacity of composite dowels in steel-concrete composite girders*. Wrocław University of Technology, Institute of Building Engineering, Report no. PRE 4/2009, PhD Thesis,
19. Seidl G., E. Viefhues, J. Berthelley, I. Mangerig, R. Wagner, W. Lorenc, M. Kozuch, J.-M. Franssen, D. Janssen, J. Ikäheimonen, R. Lundmark, O. Hechler, N. Popa.: *Research Fund for Coal and Steel, Contract N° RFSR-CT-2006-00030. 01/07/2006 - 30/06/2009. PreCo-Beam: Prefabricated enduring composite beams based on innovative shear transmission*, Final Report [to be published by EC], 2009.
20. Thomann M.: *Connexions par Adhérence pour les Ponts Mixtes Acier-Béton*. École Polytechnique Fédéral de Lousanne, Thésis Nr 3381, 2005.
21. *Untersuchungen zum Trag- und Verformungsverhalten von Verbundmitteln unter ruhender und nichtruhender Belastung bei Verwendung hochfester Werkstoffe*, AiF 13867N, FOSTA P621, Abschlussbericht, RWTH Aachen 2007.
22. Wurzer O.: *Zur Tragfähigkeit von Betondübeln*, Dissertation, Universität der Bundeswehr, München 1998.
23. Valente I., Cruz P.J.S.: *Experimental analysis of Perfobond shear connection between steel and lightweight concrete*, Journal of Constructional Steel Research 60, 2004, 465-479.
24. Zapfe C.: *Trag- und Verformungsverhalten von Verbundträgern mit Betondübeln zur Übertragung der Längsschubkräfte*, Dissertation, Universität der Bundeswehr, München 2001.

ROZWÓJ POŁĄCZEŃ ŚCINANYCH W STALOWO-BETONOWYCH KONSTRUKCJACH ZESPOLONYCH

Streszczenie

Przedstawiono typy łączników ścinanych oraz sposoby modelowania. Odniesiono się do badań prowadzonych po 2000 r., pokazano, jak rozwijał się pomysł, wprowadzony w postaci tzw. listwy perfobond, którego autorem był w 1980 r. F. Leonhardt. Najnowsze aplikacje ciągłych łączników ścinanych w mostach wykorzystują łączniki w formie tzw. composite dowels. Ostateczny kształt tego typu łączników przedstawiono w pracy.

Słowa kluczowe: połączenie ścinane, belka zespolona, composite dowels

Editor received the manuscript: 3.11.2014