

## Dynamic Vehicle Age-Based Cohort Model to Estimate the Emission from the Transportation Sector in Jakarta

Merita Gidarjati<sup>1\*</sup>, Toru Matsumoto<sup>2</sup>

<sup>1</sup> Graduate Programs in Environmental Systems, Graduate School of Environmental Engineering, University of Kitakyushu, 1-1 Hibikino, Wakamatsu-ku, Kitakyushu, Fukuoka, 808-0135, Japan

<sup>2</sup> Faculty of Environmental Engineering, University of Kitakyushu, 1-1 Hibikino, Wakamatsu-ku, Kitakyushu, Fukuoka, 808-0135, Japan

\* Corresponding author's e-mail: [mgidarjati@gmail.com](mailto:mgidarjati@gmail.com)

### ABSTRACT

Jakarta had a congestion level of 53% in 2019, ranking 10th among the most traffic jams globally. Therefore, the transportation sector is the largest contributor to air pollution in the special area of the capital city Jakarta (DKI Jakarta). In this study, a vehicle age cohort was analyzed using dynamic models. Several factors, such as emission standards, vehicle speed, as well as fuel quality and type, were included to drive the models. The emission inventory for air pollutants, such as carbon monoxide (CO), hydrocarbons (HC), nitrogen oxides (NO<sub>x</sub>), and particulate matter (PM<sub>10</sub>) can be calculated using this model. The results showed that motorbikes were the major contributor to the increase in the four pollutants in DKI Jakarta from 2007 to 2018 and will still be a significant contributor until 2040. In 2018, the major contributors to CO, HC, NO, and PM<sub>10</sub> were motorbikes (52.7%), motorbikes (79.6%), buses (63.9%), and motorbikes (74.7%), respectively. It is predicted that in 2040, using the business-as-usual (BAU) scenario, motorbikes will also be the primary contributors of air pollutants (CO, HC, and PM) 70.2%, 91.4%, and 82.9%, respectively. Diesel passenger cars will become a lesser contributor to air pollutants than all vehicles from 2018 to 2040 in DKI Jakarta.

**Keywords:** air pollution, auto cohort model, emission inventory, transportation sector.

### INTRODUCTION

DKI (Daerah Khusus Ibukota) – literally: special area of the capital city Jakarta – is one of the top cities with the worst air pollution in Southeast Asian countries and Asia in 2021. The particulate matter (PM<sub>10</sub>), ozone (O<sub>3</sub>), and carbon monoxide (CO) values in 2018 were above the international standardized limits based on the WHO standards (Kusumaningtyas et al., 2018). From 2001 to 2015, the index of PM<sub>10</sub> concentration in Jakarta, according to the Air Quality Management System (AQMS), had a yearly average about three times higher than the WHO standard values, which was 20 µg/m<sup>3</sup> on average (Rita et al., 2016). Although the WHO recommends an annual mean value of less than 20 µg/m<sup>3</sup> for PM<sub>10</sub> and 10 µg/m<sup>3</sup> for

PM<sub>2.5</sub>, the latest data retrieved in April 2018 for Jakarta demonstrated that PM<sub>10</sub> was 82 and PM<sub>2.5</sub> was 45 µg/m<sup>3</sup>. On the basis of the air quality data from Open Data Jakarta from January to October 2018, the CO, PM<sub>10</sub>, and O<sub>3</sub> concentrations were above the WHO standards limit (Kusumaningtyas et al., 2018). Vehicles burn gasoline or diesel fuel in their engines and emit CO, nitrogen oxides (NO<sub>x</sub>), unburned hydrocarbons (HC), as well as air toxics. The amount of PM is higher in diesel engines than in gasoline ones (Rita et al., 2016).

The transportation sector is the primary source of air pollution in cities, because it emits nitric oxide (NO) and carbon dioxide (CO<sub>2</sub>) in amounts corresponding to at least 30% and 14% of the total global air pollution emissions, respectively (Réquia et al., 2015). Jiang et al. (2016) revealed

that vehicular emissions are the most significant contributors to air pollution in China, which has arisen due to the increasing number of vehicles in the last decade owing to economic development and urbanization. Moreover, the PM emissions from vehicles are produced during fuel burning in vehicle machines. While the increase in the population (approximately 1%) and road length (less than 1%) is low, the number of vehicles has increased significantly (approximately 10%) in DKI Jakarta (BPS Catalogue, 2010-2017). The total number of vehicles in DKI Jakarta exceeds the total human population, as shown in Figure 1 and Figure 2 (BPS Catalogue, 2010, 2013, 2018).

Energy consumption in the transportation sector is estimated to increase at an average rate of 5.9% per year in 2012–2035, driven by the rising demand for mobility and subsidies. The low quality of public transport is expected to underlie the significant expansion in vehicle ownership.

According to previous studies, transportation has the highest contribution to the emission inventory of CO<sub>2</sub> in DKI Jakarta, in particular (Rahmawati, 2009 and Mungkasa et al., 2018). An emission test conducted in Jakarta in 2005 found that 57% of vehicles did not pass the emission standard. In 2017, the emission tests conducted on approximately 12,024 vehicles in DKI Jakarta (92% with a vehicle age range of 1–10 years, 7% 11–20 years, and 1% over 20 years old) found that almost 12% (approximately 1,400) of vehicles did not pass the standard. More than 50% of the cars tested with over 10 years of age failed the test. Vehicles aged > 40 years were also observed on the road (Open Data Jakarta).

The Government attempted to reduce air pollutants by introducing Euro 4 to replace Euro 2 fuel for passenger cars starting in October 2018, as stated in the Environment Minister’s Regulation No. 20/Setjen/Kum.1/3/2017, and by implementing

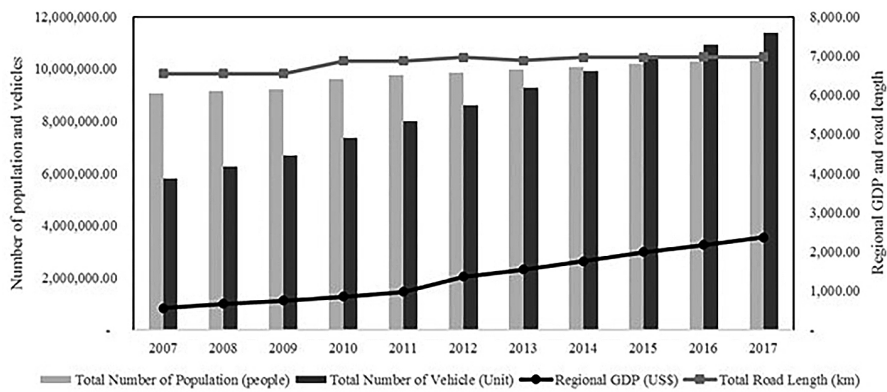

Figure 1. Total number of population, vehicle, and gross domestic product (GDP) of DKI Jakarta (2007–2017) derived from Badan Pusat Statistik/National Statistical Agency (BPS) and Samsat Polda Metro Jaya

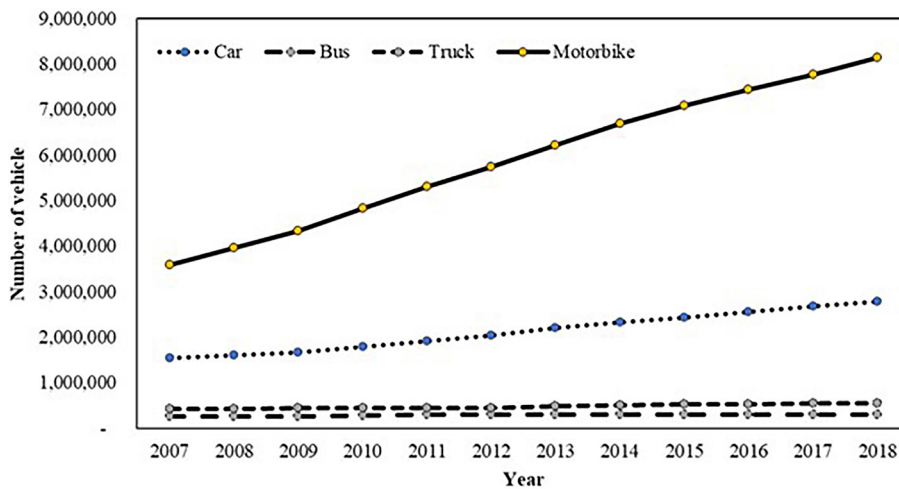

Figure 2. Total number of vehicles registered in DKI Jakarta (2007–2018) based on data from Samsat Polda Metro Jaya (received Aug 2019)

massive vehicle emission tests. Therefore, applying strict policy standards for vehicle emissions could reduce these levels (Huo et al., 2012). Converting to the Euro standard for all vehicles, including those over ten years old, the CO, NO<sub>x</sub>, HC, and PM emissions will be significantly decreased (Batjargal, 2017). The change from Euro 2 to Euro 4 is considered an essential solution for decreasing air pollutants. The emission level declines significantly as vehicle technology improves (Huo et al., 2012). The better the technology and the newer the vehicles, the better the emission levels. Therefore, vehicle emission tests are also essential for reducing the pollutants released by vehicles to preserve the air quality of the environment.

Before moving forward on whether the change from Euro 2 to Euro 4 will result in better air quality in DKI Jakarta, identifying and understanding the significant contributors to the current air pollution is crucial. Most studies in Indonesia calculated CO<sub>2</sub> emissions using total fuel consumption (Batjargal, 2017, Adhi et al., 2018, and PT. Delima Laksana Tata, 2012). The vehicle age is rarely included as a critical factor in calculating CO<sub>2</sub> emissions. Therefore, this study used dynamic models that imply the vehicle age cohort using the STELLA application to calculate the total emissions of key air pollutants. With this model, the emissions inventory for important air pollutants, particularly CO, HC, NO<sub>x</sub>, and PM<sub>10</sub>, could be calculated in more detail. Air pollutant emissions in 2040 were also predicted. To assess whether the current strategy is effective enough and to identify a possible new strategy to enable the local Government of DKI Jakarta to reach its goal in CO<sub>2</sub> emission and other essential air pollutant reduction, this study aimed to (1) determine the main contributor of air pollution from road transportation sources in DKI Jakarta from 2007 to 2018; (2) analyze the total air pollutant emissions from road transportation sources in DKI Jakarta in 2040 under the business-as-usual (BAU) scenario; and (3) understand the current implementation of the Euro 4 standard emissions.

## METHODS

Mobile emissions are influenced by several factors, including machine characteristics, driving patterns, and vehicle usage (maintenance and fuel characteristics). Developing models for emission inventories can help predict the total emissions

from mobile sources. These models should test and evaluate regulatory mechanisms for mobile source pollution control (Rita et al., 2016).

There are several ways to calculate vehicle emissions. However, in this study, a bottom-up approach using the vehicle kilometer traveled (VKT) was used to calculate the total vehicle emissions in DKI Jakarta. Vehicle emissions were estimated by calculating the sum of the aggregate emissions using vehicle population statistical data, average annual VKT, or average annual vehicle miles traveled (VMT) as emission factors of key air pollutants. The following formula was used to calculate the emissions:

$$E_i = \sum_j V_j \cdot VKT_j \cdot EF_{ij} \quad (1)$$

where  $E_i$  – the total emissions of pollutant  $i$  (grams/year);  $V_j$  – the total number of vehicles of type  $j$  on the road during that year (vehicles);  $VMT_j$  or  $VKT_j$  – the average annual miles/km traveled by vehicles of type  $j$  (mile/vehicle/year or kilometer/vehicle/year);  $EF_{ij}$  – the average emissions of pollutant  $i$  for vehicle type  $j$  (g/mile or g/km).  $EF$  – often referred to as the vehicle “emission factor” (Deaton et al., 2000).

Deaton (2000) stated that vehicle age could significantly impact emissions because when the vehicle ages, the chances of the efficiency loss of the catalytic converters increase, which may produce higher emissions. The increase in emissions over the lifetime of a vehicle is called emissions deterioration (Deaton et al., 2000). Age cohorts were used to capture the relationship between vehicle age and dynamic modeling. VKT was used according to the cohort models since vehicle emissions are mainly influenced by the emission factor of the vehicle and the frequency of vehicle usage. However, several other factors also influence vehicle emissions, which are included in the dynamic model, such as the emission standards in the studied areas, vehicle speed, fuel quality, and vehicle type.

The total vehicle population data was collected from SAMSAT Polda Metro Jaya from 2007 to 2018, whereas the vehicle categories in DKI Jakarta were retrieved from the *Badan Pusat Statistik*/National Statistical Agency (BPS). On the basis of the local regulation, the vehicle categories consisted of passenger cars (gasoline and diesel), motorbikes (gasoline), trucks (diesel), and buses (diesel). The vehicle population and the scrapped rate were

divided into three cohorts, including “age type 1” (from 2018 to 2014), “age type 2” (from 2013 to 2010), and “age type 3” (from 2009 to 2007). These cohorts of the vehicle population were determined based on the study conducted by Batjargal et al. (2017) in Ulaanbaatar. The emission standards utilized for this study derived from references in Japan. Given the underlying data for the vehicle population spanned from 2007 to 2018 (refer to Fig.2), the emission standards selected were anchored to three basis years in the Japan emission standards, namely 2005, 2009 and 2018. Because finding the annual VKT and purchase rate data is difficult, it was determined by the average value of VKT and purchase rate in the studied years.

In this study, vehicle population, age, and leakage (moved out of DKI Jakarta) were acquired from the *Sistem Administrasi Manunggal Satu Atap/One Roof Administration System (SAMSAT Office)* of Polda Metro Jaya or the Police Corps of the DKI Jakarta area. Owing to the lack of data on detailed vehicle accidents or scrapped vehicles, only the total number of vehicles that moved out from DKI Jakarta were used (Data Information on Vehicles in DKI Jakarta, SAMSAT). A constant VKT across all cohorts was used to determine VKT owing to the lack of data on VKT for each vehicle cohort category. The VKT number for passenger cars and motorbikes was acquired from the website of a major car dealer called Carmudi Indonesia (Carmudi.co.id), focusing on used cars and motorbikes sold in DKI Jakarta. VKT of buses and trucks was derived from the previous research conducted by Adhi (2018). Under the regulations of the Indonesian Government, emissions standards are differentiated only by vehicle category and not by vehicle age. Therefore, Emission Standards of Japan from dieselnets.com were used as emission standards for cars, buses, and trucks (DieselNet). The motorbike emission standards were

obtained from the transport policy.net. The accuracy of vehicle emissions calculations is highly dependent on the age distribution of the vehicle. Some regulations state vehicle scrappage when vehicles reach a certain age or have been used for a specific number of kilometers in certain areas. An increase in the number of scrapped vehicles usually follows an increase in the vehicle population. Changes in the population of vehicles result in changes in the vehicle age distribution annually. In this study, STELLA, utilized as a dynamic modelling software, has played an important role to understand the influence of the environment and make predictions of how it will evolve in the future. Leveraging the available vehicle population data and emission inventories, the software supported the development of vehicle age cohort modelling when estimating emissions. The emissions sub model in the analysis was used to calculate the total emissions produced by each type of vehicle more accurately. For this study, STELLA used 20 similar dynamic models (five vehicle categories assessing four key pollutants).

## RESULTS AND DISCUSSION

### The contributors of air pollution from road transportation

Table 1 lists the input data of the STELLA application for each vehicle classification. The data in Table 2 were used to estimate the number of emissions emitted by each vehicle type and age. As shown in Table 1, the highest VKT values were from bus. However, this was not as significant as that for motorbikes and gasoline cars. Therefore, motorbikes have the highest purchase rate among vehicles. The older the vehicle, the higher the scrap rate. The three cohorts were determined based on the available vehicle data and chosen emission

**Table 1.** Vehicle population by age cohort, and purchased and scrapped rates by age cohort

Vehicle Classification	VKT (km/year)	Vehicle population by age cohort (V)			Purchased rate	Scrapped rate by age cohort		
		Type 1	Type 2	Type 3		Type 1	Type 2	Type 3
Motorbike	2,203.24	37,111,977	26,432,833	7,548,371	0.075	0.00015	0.00153	0.00291
Passenger car - gasoline	10,631.06	11,962,622	8,987,522	2,954,544	0.053	-0.00042	0.00137	0.00317
Passenger car - diesel	12,741.47	824,788	619,663	203,707	0.053	0.00048	0.00187	0.00326
Bus	60,590.00	1,178,379	1,180,049	1,045,830	0.013	0.00048	0.00187	0.00326
Truck	12,775.00	2,642,949	2,255,341	841,637	0.024	0.00106	0.00163	0.00220



**Table 2.** Emission factor by vehicle type and age

Vehicle classification	Type of age	Emission factor (g/km)			
		CO	NO <sub>x</sub>	HC	PM
Motorbike	Type 1	2.000	0.150	0.800	0.100
	Type 2	5.500	0.300	1.200	0.100
	Type 3	5.500	0.300	1.200	0.200
Passenger car – gasoline	Type 1	1.150	0.050	0.100	0.005
	Type 2	1.150	0.050	0.050	0.005
	Type 3	1.150	0.050 </td <td>0.050</td> <td>0.005</td>	0.050	0.005
Passenger car – diesel	Type 1	0.630	0.150	0.024	0.005
	Type 2	0.630	0.080	0.024	0.005
	Type 3	0.630	0.150	0.024	0.014
Bus	Type 1	2.220	0.400	0.170	0.010
	Type 2	2.220	0.700	0.170	0.010
	Type 3	2.220	2.000	0.170	0.027
Truck	Type 1	2.220	0.400	0.170	0.010
	Type 2	2.220	0.700	0.170	0.010
	Type 3	2.220	2.000	0.170	0.027

standards. “Flow 1,” “Flow 2,” and “Final scrap” are the leakage fraction, meaning the number of vehicles being scrapped either due to accidents or breakdown or moved to other areas. On the basis of the age cohorts, the youngest vehicles contributed to emissions per kilometer. For instance, type 1 motorbikes produce half the lower emissions of CO, NO<sub>x</sub>, and HC than types 2 and 3 motorbikes. The type 1 gasoline cars, diesel cars, buses, and trucks have lower NO<sub>x</sub> emissions. These vehicles have lower PM emissions than motorbikes. The dynamic model presented in Figure 3 was used to

determine and connect the impact of each factor on the pollutants emitted. In this study, the key pollutants emitted from vehicles, including CO, HC, NO<sub>x</sub>, and PM<sub>x</sub> were calculated. Table 3 summarizes the contributions of each vehicle category/classification level to the key pollutant emissions.

Table 3 shows that the significant contributors to the air pollutants measured from 2007 to 2018 were motorbikes for CO, HC, and PM as well as buses for NO pollutants. The major contributors for CO in Jakarta among all types of vehicles from 2007 to 2018 were motorbike, a type 1 or

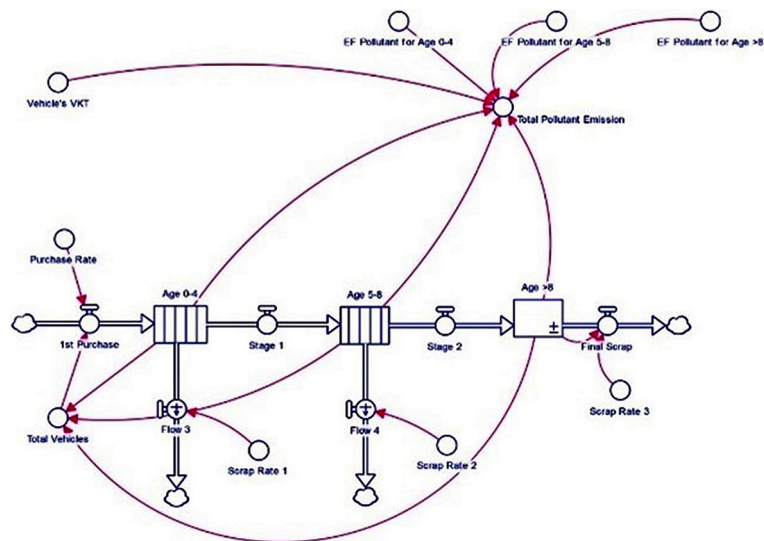

**Figure 3.** The dynamics sub-models of a vehicle using carbon monoxide (CO) as the key pollutant (similar models are drawn for other types of pollutants and vehicle categorization)

**Table 3.** Order of vehicles types contributing to air pollution in DKI Jakarta

Order	2018				2040			
	CO	HC	NO	PM	CO	HC	NO	PM
1 <sup>st</sup>	Motorbike	Motorbike	Bus	Motorbike	Motorbike	Motorbike	Bus	Motorbike
2 <sup>nd</sup>	Car gasoline	Bus	Motorbike	Car gasoline	Car gasoline	Car gasoline	Motorbike	Car gasoline
3 <sup>rd</sup>	Bus	Car Gasoline	Truck	Bus	Bus	Bus	Truck	Bus
4 <sup>th</sup>	Truck	Truck	Car Gasoline	Truck	Truck	Truck	Car Gasoline	Truck
5 <sup>th</sup>	Car diesel	Car diesel	Car diesel	Car diesel	Car diesel	Car diesel	Car diesel	Car diesel

the youngest age group due to their greatest unit number compared to other vehicle age cohorts. Réquia et al. (2015) showed that light-duty vehicles (LDV) were the major contributor to CO emissions, resulting in as much as 68.9%, and heavy-duty vehicles (HDV) were the major contributor for NO emission, resulting in as much as 90.7%. Therefore, the primary contributor to air pollutants in DKI Jakarta will be CO, among the other pollutants in 2040, using the BAU scenario. Gasoline cars will be the second contributor to CO, HC, and PM pollutants until 2040. Diesel cars have the lowest number of emissions compared to other vehicle categories. Therefore, they will be the minor contributor to all pollutants.

From 2007 to 2018, the CO emissions from motorbikes were the highest of the total CO emissions in DKI Jakarta, followed by those from gasoline, buses, trucks, and diesel cars. The relationship between the total number of vehicles and their contribution to air pollution was relatively strong. Between 2007 and 2018, motorbikes accounted for

almost 67% of all vehicles in DKI Jakarta, followed by gasoline cars (approximately 23%), trucks, buses, and diesel cars, consecutively. Among all types of vehicles, the major contributors were motorbikes and buses, followed by trucks. In 2040, buses will be the primary contributor to NO emissions. However, car gasoline is predicted to produce higher HC emissions in 2040 than buses in 2018. This situation may be due to the annual increasing number of gasoline-passenger cars as well as the decreasing number of buses, because most buses are considered public transportation, and they need to follow the regulation on age limitation for the bus to operate, which is a maximum of 10 years. Table 4 shows the significant contributors of air pollutants in 2007, 2018, and 2040.

**Total emission estimation from transportation sources**

From 2007 to 2040, LDVs, such as cars and motorbikes, are significant contributors to CO

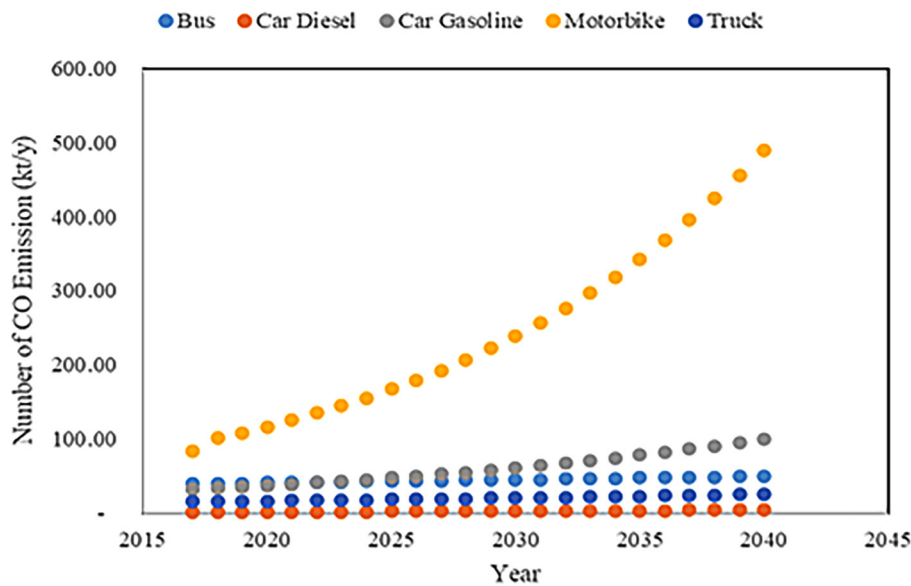

**Figure 4.** Predicted CO emission in DKI Jakarta from 2018 to 2040

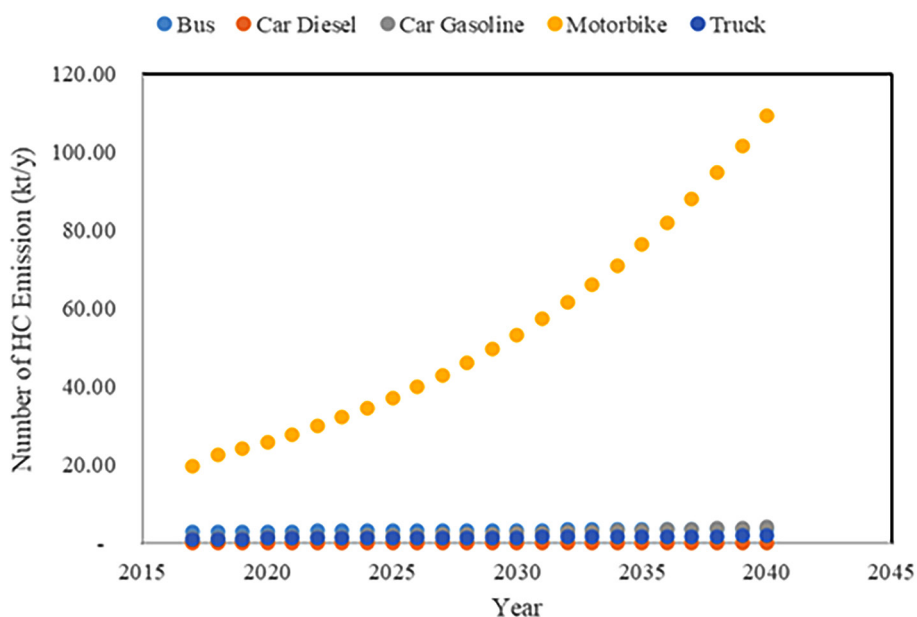

Figure 5. Predicted HC emission in DKI Jakarta from 2018 to 2040

Table 4. Major contributors to CO, HC, NO, and PM in DKI Jakarta in 2007, 2018, and 2040

Year	Parameter	Bus	Car Diesel	Car Gasoline	Motorbike	Truck
2007	CO	30.2%	0.9%	19.4%	38.8%	10.7%
	HC	15.8%	0.2%	8.6%	69.8%	5.6%
	NO	65.9%	0.8%	4.1%	11.4%	17.7%
	PM	13.5%	0.5%	5.5%	76.5%	3.9%
2018	CO	20.9%	0.8%	17.5%	52.7%	8.2%
	HC	10.8%	0.2%	5.1%	79.6%	4.2%
	NO	63.9%	0.6%	2.6%	10.0%	23.0%
	PM	0.4%	0.0%	24.8%	74.7%	0.1%
2040	CO	7.4%	1.0%	21.3%	70.2%	8.9%
	HC	3.2%	0.1%	3.6%	91.4%	1.6%
	NO	44.7%	1.1%	4.4%	27.4%	22.4%
	PM	0.1%	0.0%	17.0%	82.9%	0.1%

Note: CO, carbon monoxide; HC, hydrocarbons; NO, nitric oxide; PM, particulate matter.

emissions (61.29%). The significant contributors to NO pollutant emissions were HDV, such as buses, accounting for 44.70% (Wang et al., 2019). Previous studies also showed similar results, where HDV contributed to 50% of NO pollutant emissions. Air emissions are directly correlated with the dominant vehicle type (Jiang et al., 2016 and Tao et al., 2018). If the vehicle type with the highest number of vehicles is HDV, the highest emissions will be from the pollutants NO<sub>x</sub> and PM. Souza et al. (2013) stated that gasoline vehicles were the most significant contributors to CO pollutants (74%), whereas diesel vehicles were the most significant contributors to PM (91%).

These vehicles were the most significant contributors to total hydrocarbons (THC) by as much as 61.4%. Bellagio et al. (2007) stated that gasoline-fueled cars were the most significant contributors to CO pollutant (72.7%), PM (36.5%), and NO<sub>x</sub> (32.1%), whereas motorbikes were minor contributors to CO pollutants.

However, the use of alternative fuels does not significantly reduce the number of pollutants. Gasoline-fueled LDVs were minor contributors of NO<sub>x</sub> pollutants, and passenger cars with liquefied petroleum gas (LPG) as a fuel were minor contributors of PM (Bellagio et al., 2007). Mishra et al. (2014) concluded that cars with alternative

fuels to methane, such as compressed natural gas (CNG), were the most significant contributors to  $\text{NO}_x$  pollutant (29.38%) in 2012. In this research, the total number of motorbikes (LDV) increased significantly compared to buses (HDV) and other vehicle types (see Fig. 4(a–d)); it can be predicted that the most significant contributor of air pollutants in DKI Jakarta will be motorbikes until the end of the predicted year.

From 2007 to 2018, the major contributor to CO in the motorbike category among the three age cohorts was type 1 or the younger/newest motorbikes. Younger motorbikes had enormous numbers among the other two age cohorts, based on vehicle population data. If there are no interventions for the population, the air pollution contributors will be the same. Dill (2004) stated that a scrapping program for vehicles based on vehicle age could reduce emissions, but not as much as it was predicted. In the worst-case scenario, the CO emissions reduction could only reach 20%. In DKI Jakarta, there was already a local regulation issued in 2019 by the governor on limiting the age of vehicles to 10 years for private vehicles starting in 2025. If implemented, this regulation will undoubtedly help reduce the CO emissions in DKI Jakarta. However, national laws need to be revised to enable the implementation of local regulations in the field.

Moral et al. (2019) demonstrated that the emission of  $\text{NO}_x$  from a new vehicle was lower than that from a scrapped vehicle (assumed to

be the same as that of 10-year-old cars). The total emission of  $\text{NO}_x$  for a new car was 12.63 tons while that for the scrapped car was 18.65 ton (Moral et al., 2019). Lumbreras et al. (2008) also mentioned that vehicle renewal was the most effective alternative policy for decreasing  $\text{NO}_x$  emissions (24.70%),  $\text{PM}_{10}$  (17.63%),  $\text{PM}_{2.5}$  (21.19%), and CO (21.19%). The older the vehicle, the higher the emissions which will be released by the vehicle. Wang et al. (2019) found that a policy for scrapping yellow tags decreased air pollution emissions. The yellow-tagged vehicle (TVs) is an LDV that fulfills the emission standards of China III. The implementation of TVs saw decreased emission of  $\text{PM}_{2.5}$ ,  $\text{PM}_{10}$ ,  $\text{NO}_x$ , CO, and HC as much as 16.46 kt (kilotons), 18.12 kt, 174.44 kt, 669.11 kt, and 91.64 kt, respectively, from year 2008 to 2015 (Wang et al., 2019). Wee et al. (2011) demonstrated that the scrapping policy for vehicles is effective because of its the low cost. This policy can be applied to the areas with a high population and to vehicles with old technology for emission control. Limiting old private vehicles running on the streets of DKI Jakarta would be an excellent intervention for improving air quality.

From 2007 to 2040, gasoline cars will be the second-largest contributors to CO and PM pollutants after motorbikes (Figure 7). The total number of cars using gasoline was considerably lower than that of motorbikes. The total number of cars in DKI Jakarta in 2018 was four times

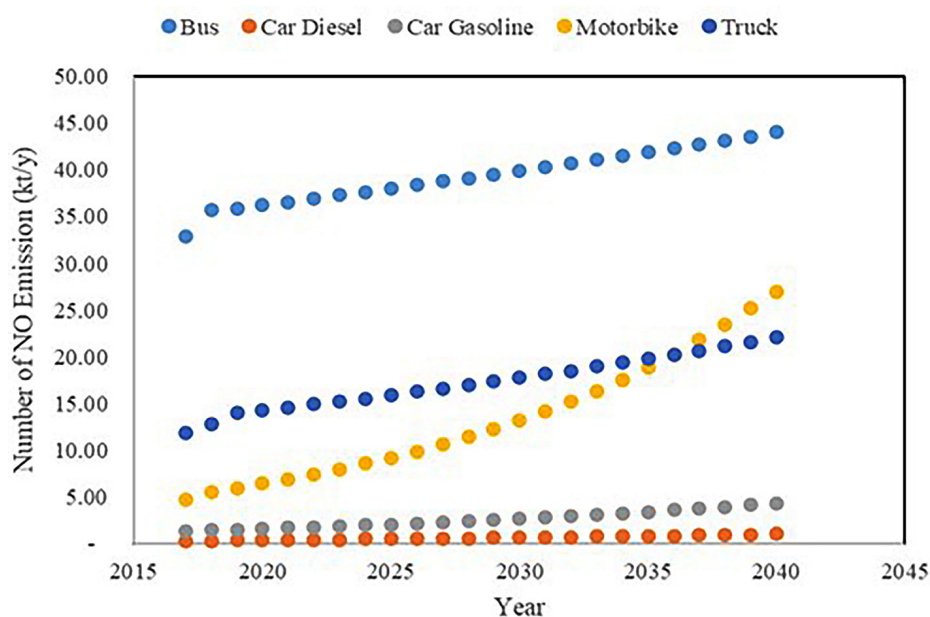
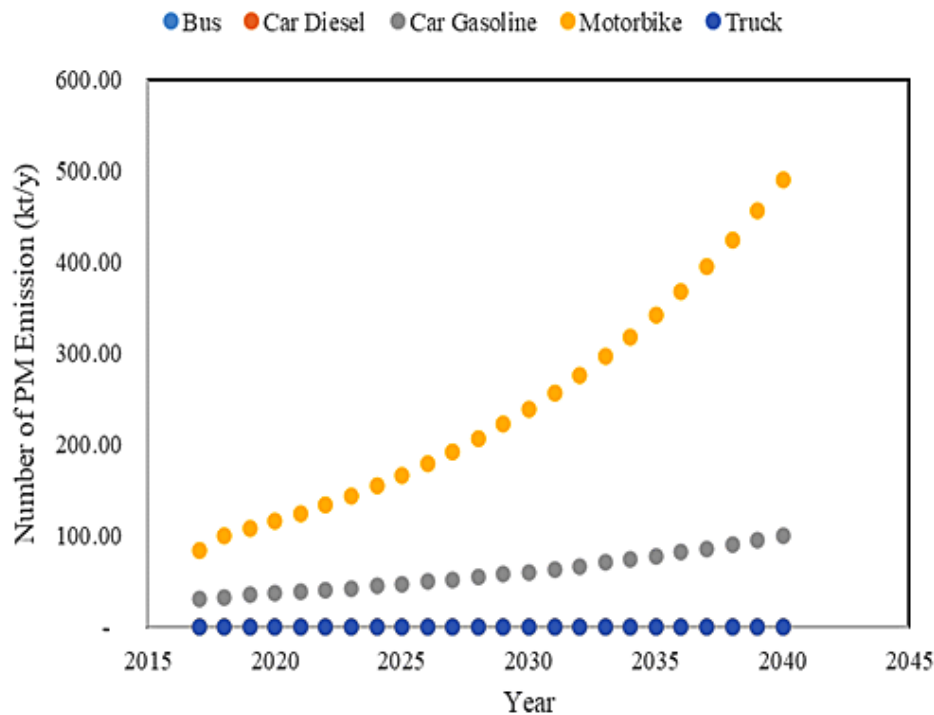

Figure 6. Predicted NO emission in DKI Jakarta from 2018 to 2040





**Figure 7.** Predicted PM emission in DKI Jakarta from 2018 to 2040

that in 2007, whereas the number of motorbikes was five. The percentage of motorbikes increasing annually is also much higher than that of gasoline-powered cars. Therefore, even though car emissions are more significant than those of motorbikes, the total number of pollutants from motorbikes remains far higher than that of gasoline cars. If there is no intervention to decrease the number of vehicles (cars or motorbikes), pollution in DKI Jakarta will worsen.

Vehicle age and number are significant factors when recommending policies to reduce emissions. Pastorello et al. (2017) stated that the PM emissions from vehicles with gasoline and diesel as fuels would decrease by approximately 20% after applying the vehicle scrapping policy with a certain VKT. They also found in their study that the average mileage traveled for a 10-year-old car was approximately 40% of the same car (gasoline or diesel) in its first year or decreased to 10% of the 20-year-old car (Pastorello et al., 2017). Consequently, the PM emissions of a passenger vehicle decrease by more than 20% because the average kilometers traveled by an older car decreases. This finding demonstrates the importance of estimating the average kilometers traveled for every vehicle category and age.

Several policies have been implemented to improve the air quality and reduce air pollution

in cities. These policies are implemented by limiting the number of vehicles on the streets, applying odd and even vehicle plate numbers, limiting the type of vehicles passing on certain roads, improving fuel quality, limiting vehicle age, or applying scrappage policies. Li et al. (2018) explained the policy to limit the number of vehicles in Langfang, China, based on vehicle plate numbers or License plate recognition (LPR), which was implemented by two methods, one-day-per-week (ODPW) and odd-and-even (OAE). The shift from the ODPW policy to the OAE has significantly increased the vehicle speed on the more prominent streets, whether during peak hours or not. This policy has also directly influenced a reduction in traffic volumes. Traffic volume was reduced by approximately 8.74% after the implementation of the OAE policy (replacing the previous ODPW policy). DKI Jakarta has already regulated odd and even numbers of vehicles since 2016. This is due to the increasing number of vehicles, particularly LDV. DKI Jakarta may need to learn from other countries, such as Brazil, and their programs. Szwarcfiter et al. (2005) demonstrated that the Brazilian Motor Vehicle Air Pollution Control Program (PROCONVE) policy implemented from 2003 to 2010 targeted LDV. The program reduced the CO, HC, and NO<sub>x</sub> emissions by 51%, 47%, and 50%, respectively (Szwarcfiter et al., 2005).

## The current situation of euro 4 implementation in Jakarta

Full implementation of the Euro 4 standard fuel was postponed until 2022 in DKI Jakarta. Although all gas stations in DKI Jakarta have Euro 4, there is insufficient fuel to meet this demand. Moreover, a facility for conducting emission tests on vehicles is under construction. The residents of DKI Jakarta are not following the local government regulation to switch to Euro 4 gasoline, because its promotion by the local government is lacking; there are many residents who do not know the emission impact of using Euro 4 gasoline on air quality and weak law enforcement by the local government (Purwanto, 2021).

As reported by Hirota and Kashima (2020), the introduction of Euro 4 was postponed twice: in 2013 and 2017. The implementation of Euro 4 standard vehicles was also postponed twice, from 2018 to 2022. Simultaneously, the share of production was relatively low. It seems impossible for only 1.4% of the Indonesian fuel market to achieve the national target in the following years (Hirota, 2020). Therefore, if the total number of gasoline cars and motorcycles used the Euro 4 standard in DKI Jakarta in 2018 and the emission factors were collected from Huo et al. (2012), then the CO, HC, and NO<sub>x</sub> emissions in 2022 would be nine times lower (Fu et al., 2013). Because the data on the current implementation of Euro 4 is lacking and the entire project implementation has been postponed, this research was limited to the existing use of Euro 2 standard vehicles.

Fu et al. (2013) found that the emission of NO<sub>x</sub> from HDV became the primary pollutant source influencing the air quality in Chinese cities. The emission factors of NO<sub>x</sub> measured from buses were 1.60-, 1.16-, 1.77-, 1.27-, 2.49- and 2.44- times higher than the NO<sub>x</sub> predicted by the Euro 4 model for vehicles in the city, suburb, and highway (Huo et al., 2012). Therefore, adjusting the essential emission factor from a local study is highly encouraged in the Euro 4 model to improve emission estimation. Wang et al. (2018) found that the elimination of old vehicles and upgrading fuel quality contributed to a decrease in emissions in Tianjin, Beijing, and Hebei City, China (Wang et al., 2018). Lee et al. (2019) stated that the emission factor of NO<sub>x</sub> for Euro 4 for LDV only estimated 27–31% of the NO<sub>x</sub> emissions on the street. This weak representation was caused by low acceleration during the driving cycle and

limited monitoring tools (valve degradation of EGR/exhaust gas recirculation). This condition also proved that the standard emission for Euro 4 for the LDV was highly dependent on vehicle age. If the vehicle is already old (as is the case in Korea today), then the measurement of emission of NO<sub>x</sub> with this standard would be accurate and helpful in increasing the effectiveness of emission control. If the vehicle is still new, then a complete change is required to the diagnostic system and the valve tools for its EGR. Therefore, the Euro 4 emissions policy for passenger cars has high uncertainty (Kraan et al., 2014).

## CONCLUSIONS

Identifying the specific contributors of each pollutant is essential to better address the air pollution problem. On the basis of the results of this study, motorbikes were the primary contributors to the emission of air pollutants CO, HC, and PM, and buses were the primary contributors to NO from 2007 to 2018 in DKI Jakarta. If there is no intervention to address this issue shortly or until 2040, the primary contributor will still be motorbikes, followed by passenger gasoline cars. This study also concluded that LDVs are major contributors to air pollutants in DKI Jakarta. Significant interventions to reduce LDVs in DKI Jakarta will improve the air quality. Using the auto cohort with emission sub-model enabled this study to confirm that the age of the vehicles is essential. However, the increased number of vehicles in DKI Jakarta is an even more critical issue to address. Knowing the source of the problem will help produce a better solution to address each specific problem. For instance, if the source of the problem is the increasing number of motorbikes, then some regulations, such as the limitation of motorbike ownership, limiting the area where people can ride a motorbike, and intensive emission tests for motorbikes produced before 2013, can be applied. The author also believes that the Indonesian Government needs to produce more detailed emission factors that fit the local situation. Implementing Euro 4 will likely decrease the air pollution caused by private passenger cars, because some of the data used in this study were collected using references from other countries. Therefore, a future study is required to determine the actual emissions of different vehicle categories and fuels. Future studies should focus on how the implementation of the Euro 4 in Indonesia could work as planned.

## Acknowledgment

The authors express their gratitude to the Matsumoto Laboratory, Graduate Programs in Environmental Systems, Graduate School of Environmental Engineering, The University of Kitakyushu, Japan, for their valuable support and assistance in facilitating this research endeavor.

## REFERENCES

1. Kusumaningtyas, S.D.A., Aldrian, E., Wati, T., Atmoko, D., Sunaryo, S. 2018. The Recent State of Ambient Air Quality in Jakarta. *Aerosol and Air Quality Research*, 18(9), 2343–2354.
2. Rita, R., Lestiani, D.D., Panjaitan, E.H., Santoso, M., Yulinawati, H. 2016. Kualitas Udara (PM<sub>10</sub> dan PM<sub>2.5</sub>) [Air Quality (PM<sub>10</sub> dan PM<sub>2.5</sub>)], Untuk Melengkapi Kajian Indeks Kualitas Lingkungan Hidup, *Ecolab*, 10(1), 1–7.
3. Open Data Jakarta: Indeks Standar Pencemar Udara Di Provinsi DKI Jakarta Tahun 2018. 2018. <http://data.jakarta.go.id/dataset/indeks-standar-pencemar-udara-di-provinsi-dki-jakarta-tahun-2018>.
4. Deaton, Michael L. & James J. Winebrake. 2000. *Dynamic Modeling of Environmental Systems*. Textbook, 142–157.
5. Réquia, W.J., Koutrakis, P., and Roig, H.L. 2015. Spatial Distribution of vehicle emission inventories in the federal district, Brazil. *Atmospheric Environment*, 112, 32–39.
6. Jiang, W., Sun, S., and Gao, W. 2016. Vehicle emission trends and spatial distribution in Shandong Province, China, from 2000 to 2014. *Atmospheric Environment*, 147, 190–199.
7. Badan Pusat Statistik/BPS Provinsi DKI Jakarta (2010–2017), Statistik Daerah Prov DKI Jakarta 2010–2017 (Local Statistics of DKI Jakarta Province 2010–2017), BPS Catalogue.
8. Badan Pusat Statistik/BPS Provinsi DKI Jakarta (2010, 2013, 2018), Statistik Transportasi DKI Jakarta Tahun 2010, 2013, 2018 (Transportation Statistics of DKI Jakarta 2010, 2013, 2018), BPS Catalogue.
9. Rahmawati. 2009. *Analisa Penerapan Kebijakan Pengendalian Pencemaran Udara dari Kendaraan Bermotor Berdasarkan Estimasi Beban Emisi (Studi Kasus: DKI Jakarta) (Analysis of Policy Implementation on Controlling the Air Pollution from Vehicle Based on the Estimation of Emission Load)*, Thesis of Post Graduate School of IPB.
10. Mungkasa, Dr.Ir. Oswar Muadzin, Andono Warih. 2018. *Air Quality of Jakarta: Conditions, Challenges and Priorities*, Presentation.
11. Open Data Jakarta. 2018. Data Hasil Uji Emisi Tahun 2017 (Data of Emission Test Result in 2017), <http://data.jakarta.go.id/dataset/data-hasil-uji-emisi>, Local Government website.
12. Huo, H., Yao, Z., Zhang, Y., Shen, X., Zhang, Q, Ding, Y., He, K. 2012. On-board measurements of emissions from light-duty gasoline vehicles in three mega-cities of China. *Atmospheric Environment*, 49, 371–377.
13. Batjargal, Bayasgalan, Matsumoto, Toru. 2017. Emission and prediction of road traffic emissions in Ulaanbaatar. *Journal of Japan Society of Civil Engineers Ser G (Environmental Research)*, 73(5), 183–190.
14. Nur, Yusratika, Puji Lestari, & IGA Uttari. 2008. Inventori Emisi Gas Rumah Kaca (CO<sub>2</sub> and CH<sub>4</sub>) Dari Sektor Transportasi Di DKI Jakarta Berdasarkan Konsumsi Bahan Bakar [Emission Inventory of GHG (CO<sub>2</sub> and CH<sub>4</sub>) of Transportation Sector in DKI Jakarta Based on the Fuel Consumption], <https://www.academia.edu/>.
15. Adhi, Rizky Pratama. 2018. Top-Down and Bottom-Up Method on Measuring CO<sub>2</sub> Emission from Road-Based Transportation System (Case Study: Entire Gasoline Consumption, Bus Rapid Transit, and Highway in Jakarta, Indonesia), *Jurnal Teknik Lingkungan. Environmental Engineering Journal*, 19(2), 249–258.
16. PT. Delima Laksana Tata. 2012. *Studi Perhitungan Emisi CO<sub>2</sub> Pada Setiap Kendaraan Bermotor Transportasi Jalan (Study on CO<sub>2</sub> emission calculation for every vehicle on road transportation)*. Final Report of Project Document for Transportation Department in Indonesia.
17. DKI Jakarta Local Government Regulation. 2014. *Perda No 5 the Year 2014 on Transportation*, Local Government's Regulation.
18. Data Information on Vehicles in DKI Jakarta, SAM-SAT (*Sistem Administrasi Manunggal Satu Atap/ One roof administration system*) of Polda Metro Jaya or Police Corps for DKI Jakarta area, Received 20th Aug 2019.
19. Anonymous. [carmudi.co.id](http://carmudi.co.id), Retrieved 20th Aug 2019.
20. DieselNet: Emission Standards, <https://www.dieselnet.com/standards/jp/ld.php>, Ecopoint Inc., Retrieved 10th September 2019.
21. Transport Policy: Vietnam Motorcycles Emissions, <https://www.transportpolicy.net/standard/vietnam-motorcycles-emissions/> Retrieved 27th September 2019.
22. Wang, P., Sun, S., Zao, G., Wanfg, T., Jin, J., Lin, Y., Li, H., Ying, Q., and Mao, H. 2019. Past and future trends of vehicle emissions in Tianjin, China, from 2000 to 2030. *Atmospheric Environment*, 209, 182–191.
23. Tao, J., Qi, L., and Wenzhong, S. 2018. Estimation and analysis of emissions from on-road vehicles in mainland china for the period 2011 – 2015. *Atmospheric Environment*, 191, 500–512.
24. Souza, C.D.R., Silva, S.D., Silva, M.A.V., D'Agosto,

- M.A., and Barboza, A.P. 2013. Inventory of conventional air pollutants emissions from road transportation for the state of Rio de Janeiro. *Energy Policy*, 53, 125–135.
25. Bellagio, R., Bianconi, R., Corda, G., and Cucca, P. 2007. Emission inventory for the road transport sector in Sardinia (Italy). *Atmospheric Environment*, 41, 677–691.
  26. Mishra, D. and Goyal, P. 2014. Estimation of vehicle emissions using dynamics emission factors. A Case Study of Delhi, India. *Atmospheric Environment*, 98, 1–7.
  27. Dill, J. 2004. Estimating Emissions Reductions from accelerated vehicle retirement program. *Transportation Research Part D: Transport and Environment*, 9(2), 87–106.
  28. Moral, M.J., and Laborda, J. 2019. Scrappage by age: cash for clunkers matters!. *Transportation Research Part A: Policy and Practice*, 124, 488–504.
  29. Lumbreras, J., Valdés, M., Borge, R., and Rodríguez, M.E. 2008. Assessment of vehicle emission projections in Madrid (Spain) from 2004 to 2012 considering several control strategies. *Transportation Research Part A: Policy and Practice*, 42(4), 646–658.
  30. Wang, J., Jiang, H., Zhou, J., Cheng, X., Lu, Y., Zhang, W., Bi, J., Xue, W., and Liu, N. 2019. cost-benefit analysis of yellow-label vehicles scrappage subsidy policy: a case study of Beijing-Tianjin-Hebei region of China. *Journal of Cleaner Production*, 232, 94–103.
  31. Wee, B. V., Jong, G. D., and Nijland, H. 2011. Accelerating car scrappage: a review of research into the environmental impacts. *Transport Reviews*, 31(5), 549–569.
  32. Pastorello, C., Caserini, S., Gaifami, P., and Ntziachristos, L. 2017. Impact of the dropping activity with vehicle age on air pollutant emission. *Atmospheric Pollution Research*, 4, 282–289.
  33. Li, R., Liu, Z., Wang, X., and Shang, P. 2018. Effects of vehicle restriction policies: analysis using license plate recognition data in Langfang, China. *Transportation Research Part A: Policy and Practice*, 118, 89–103.
  34. Szwarcfiter, L., Mendes, F.E, and Rovere, ELL. 2005. Enhancing the effects of the Brazilian program to reduce atmospheric pollutant emissions from vehicles. *Transportation Research Part D: Transport and Environment*, 10(2), 153–160.
  35. Purwanto, A.J.: Synchronizing Indonesia’s Diesel Fuel Policy. <https://www.eria.org/news-and-views/synchronizing-indonesias-diesel-fuel-policy/>. Retrieved 19th August 2021.
  36. Hirota, K., Kashima, S. 2020. How are automobile fuel quality standards guaranteed? Evidence from Indonesia, Malaysia and Vietnam. *Transportation Research Interdisciplinary Perspectives*, 4, 100089.
  37. Fu, M., Ge, Y., Wang, Y., Tan, J., Yu, L., and Liang, B. 2013. NO<sub>x</sub> Emission from Euro IV Buses with SCR systems associated with urban, suburban, and freeway driving patterns. *Science of the Total Environment*, 452–453, 222–226.
  38. Wang, X., Yang, W., Yu, C., Yuan, W., Wu, X., and Zhang, W. 2018. High-resolution vehicle emission inventory and emission control policy scenario analysis, a case in the Beijing-Tianjin-Hebei (BTH) region, China. *Journal of Cleaner Production*, 203, 530–539.
  39. Lee, T., Shin, M., Lee, B., Chung, J., Kim, D., Keel, J., Lee, S., Kim, I., and Hong, Y. 2019. Rethinking NO<sub>x</sub> emission factors considering on-road driving with malfunction emission control systems: a case study of Korean Euro 4 light-duty diesel vehicles. *Atmospheric Environment*, 202, 212–222.
  40. Kraan, T.C., Ligterink, N.E., and Hensema, A. 2014. Uncertainties in emission of road traffic: Euro-4 diesel NO<sub>x</sub> emissions as case study. TNO Report 2012 R11316, 13–17.