

10.24425/acs.2018.125487

*Archives of Control Sciences*  
Volume 28(LXIV), 2018  
No. 4, pages 635–682

# A comparative study of 2DOF PID and 2DOF fractional order PID controllers on a class of unstable systems

KISHORE BINGI, ROSDIAZLI IBRAHIM, MOHD NOH KARSITI, SABO MIYA HASSAN and VIVEKANANDA RAJAH HARINDRAN

The proportional-integral-derivative (PID) controllers have experienced series of structural modifications and improvements. Example of such modifications are set-point weighting and fractional ordering. While the former is to achieve two-degree-of-freedom (2DOF) ability of set-point tracking and disturbance rejection, the latter is to ensure smooth control action. Therefore, this paper reviews various forms of PID controllers and provides a comparative analysis of 2DOF PID and 2DOF fractional order PID (FOPID) controllers. The paper also discusses the conversion of one PID form to another. For the comparative analysis of the various controllers, a class of unstable systems are considered. Simulation result shows that in most cases the conversion from one form to another does not significantly affect the performance of the system. It is also observed that the 2DOF controllers (2DOF PID and 2DOF FOPID) improved significantly the performance of the ordinary PID controllers.

**Key words:** fractional order controller, set-point weighting, 2DOF PID, process control; unstable systems

## 1. Introduction

PID controllers are the most widely used for low-level control in the process industry. The main aim of these controllers is to achieve good set-point tracking and disturbance rejection response. PID controllers gain this popularity owing to their simple structure and ease of tuning [1–6]. Over the time, many modifications of PID are proposed by various researchers. This is due to the failure of conventional PID structure to achieve robust performance under conditions such

---

K. Binti, the corresponding author (E-mail: bingi.sai\_g03426@utp.edu.my) and R. Ibrahim, M. Noh Karsiti, S. Miya Hassan are with Department of Electrical and Electronics Engineering, Universiti Teknologi PETRONAS, Seri Iskandar, 32610 Tronoh, Perak, Malaysia.

V. Rajah Harindran is with PETRONAS Group Technical Solutions, Dayabumi Complex, Jalan Sultan Hishamuddin, 50050 Kuala Lumpur, Malaysia.

This research was supported by Universiti Teknologi PETRONAS (UTP) through the Award of Yayasan UTP Fundamental Research under Grant No: 0153AA-H16.

Received 11.11.2017.

as the change in process dynamics, variation in set-point, high external disturbance, long deadtime etc. Among the various modifications of PID are fractional order PID (FOPID), Two-degree-of-freedom (2DOF) PID, Predictive PI, Smith predictor, Non-linear PID, PI-PD, Enhanced PID, etc. Of these PID variants, the 2DOF PID and FOPID received the most attention recently. This is because, compared to conventional PIDs, the 2DOF PIDs have the advantage of handling both set-point tracking and load regulation while the fractional order controllers provide robust control performance [7–14].

Currently, there are a few reported works on 2DOF FOPID controllers. For example, Fabrizio Padula et al. [15], proposed an analytical set-point weight tuning rules for FOPID controllers. The proposed tuning rules are used to optimize the disturbance rejection performance of the first order plus deadtime (FOPDT), integrator plus dead time (IPDT), unstable first order plus dead time (UFOPDT) and higher order systems. In another work by Richa Sharma et al. [8], a parallel 2DOF FOPID controller was implemented for a two-link robotic manipulator. The parameters of the controller are tuned using cuckoo search (CS) algorithm. Similarly, the authors of [9] and [10] implemented 2DOF FOPID controller for the underactuated rotary single inverted pendulum and magnetic levitation system respectively. In both papers, the authors used frequency domain analysis to tune fractional order parameters while the set-point weighting parameters are tuned using pole placement method. Kishore Bingi et al. [7] designed a fractional order set-point weighted PID controller ( $SWPI^\lambda D^\mu$ ) for pH neutralization process plant. The parameters of the controller are tuned using accelerated particle swarm optimization algorithm. A common feature of the works in [8, 9, 15] and [10] is the use of standard configuration of 2DOF FOPID while [7] used both standard and industrial forms.

The pre-filter configuration of the 2DOF FOPID have also been considered by Sanjoy Debbarma et al. in [12–14]. The controller was designed for automatic generation control of three area thermal power system. Here, the controller parameters are tuned using CS and firefly algorithms. Using similar configuration, Roohallah Azarmi et al. [11] implemented the controller on a laboratory scale CE 150 twin rotor helicopter. Here, the authors tuned the controller using an analytical method. This type of tuning method for the 2DOF FOPID is also reported in [16] where it is used to control vertical magnetic flux in Denmavand tokamak using component separated configuration. In a related development, Mingjie Li et al. [17] designed 2DOF FOPID controllers for fractional order processes with dead-time using internal model control (IMC) based design. However, the analytical tuning method considered here is based on maximum sensitivity ( $M_s$ ) function instead of pole placement methods considered in [11, 16]. Thus, this paper presents a comprehensive analysis of various PID structures and comparative study of various forms of FOPID, 2DOF PID and 2DOF FOPID controllers. It should be noted that the 2DOF FOPID structures are developed based on our earlier work reported in [7].

The rest of the paper is organized as follows: Section 2 gives the basic definitions of fractional differintegral operator, fractional derivative and refined Oustaloup filter. In Section 3, various forms of PID controllers with block diagrams and conversion formulas to get the controller parameters from one specific PID to another are provided. In Section 4, the 2DOF forms of PID controllers derived from Section 3 with conversion formulas and the books related to these 2DOF PID are presented. The fractional order forms of PID controllers and the MATLAB based toolboxes for implementing these controllers are given in Section 5. In Section 6, the fractional forms of 2DOF PID controllers derived from Section 4, equivalent configurations of 2DOF FOPID and the parameters of various controllers are presented. A comparative study on a class of unstable systems with all the controllers considered are given in Section 7. Finally, concluded in Section 8. The complete content organization of the article is shown in Figure 1.

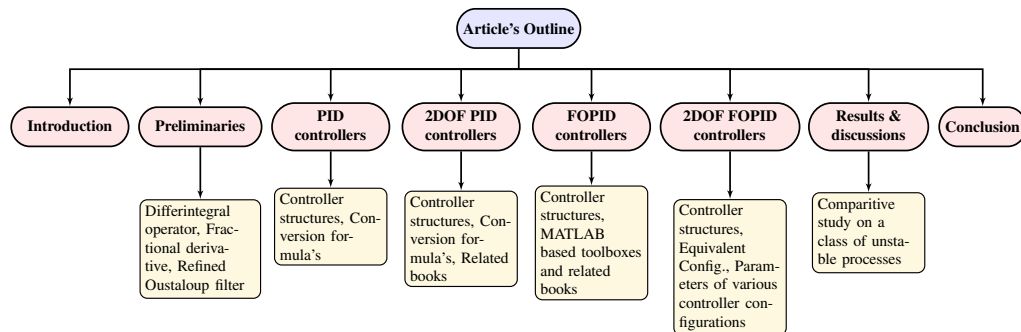

Figure 1: Content organization of the article

## 2. Preliminaries

### 2.1. Differintegral operator ( $\mathcal{D}_i^q$ )

The fractional order differintegral operator (a combined differentiator/integrator)  $\mathcal{D}_i^q$  for the function  $f(t)$  of order  $q \in \mathbb{R}$ , that generalizes the notations for derivatives ( $q > 0$ ) and integrals ( $q < 0$ ) according to [2, 18, 19] is defined as

$$\mathcal{D}_i^q(f(t)) = \begin{cases} \frac{d^q f(t)}{dt^q} & q > 0, \\ f(t) & q = 0, \\ \int_0^t f(\tau) d\tau^q & q < 0. \end{cases} \quad (1)$$

## 2.2. Definitions of fractional derivative

The fractional derivative in (1) can be defined in many forms such as Liouville, Riemann-Liouville, Weyl, Marchaud, Cauchy, Marchaud, Fourier, Davidson-Essex, Coimbra, Canavati, Jumarie, Riesz, Cossar, Osler, Hadamard, Grünwald-Letnikov, Abel, Chen, Caputo, [2, 19–22] etc. However, the Caputo definition is the most widely used in control engineering applications [11, 23, 24] and is defined as follows

$$\mathcal{D}_t^q(f(t)) = \frac{1}{\Gamma(n-q)} \int_0^t \frac{f^{(n)}(\tau)}{(t-\tau)^{q-n+1}} d\tau, \quad (2)$$

where  $f^{(n)}(\cdot)$  is the  $n^{\text{th}}$  derivative of the function  $f(t)$ , such that  $n-1 < q < n$ ,  $n \in \mathbb{N}$  and the gamma function,  $\Gamma(n)$  is defined as

$$\Gamma(n) = \int_0^t \tau^{n-1} e^{-\tau} d\tau = (n-1)!. \quad (3)$$

The Laplace transform of (2) at zero initial conditions is given as

$$\mathcal{L}\{\mathcal{D}_t^q(f(t)); s\} = s^q F(s). \quad (4)$$

## 2.3. Refined oustaloup filter

The fractional order operator  $s^q$  in (4) can be approximated to integer order using various techniques such as continued fraction expansions, power series expansions, Carlson, Chareff, Wang, SC Dutta Roy, Matsuba, Oustaloup recursive approximation, refined Oustaloup filter, least square method, Prony, Euler, Tustin etc [25, 26]. However, the refined Oustaloup filter technique is a very flexible and most reliable approximation method [19, 27, 28] which is defined in a frequency range  $(\omega_l, \omega_h)$  as follows

$$s^q \approx K \left( \frac{bs^2 + a\omega_h s}{b(1-q)s^2 + a\omega_h s + bq} \right) \prod_{k=-N}^N \frac{s + \omega'_k}{s + \omega_k}, \quad (5)$$

where

- $q \in (0, 1)$  is the fractional order parameter,
- $N$  is the order of approximation,
- $\omega_l, \omega_h$  are the lower and higher order frequency bounds,
- $a, b \in \mathbb{Z}^+$  are performance improvement constants chosen for good response as 10 and 9 respectively [29].

The gain ( $K$ ), zeros ( $\omega'_k$ ) and poles ( $\omega_k$ ) of  $s^q$  in (5) are given as follows:

$$\begin{aligned}
 K &= \left( \frac{b\omega_h}{a} \right)^q \\
 \omega'_k &= \omega_l \left( \frac{\omega_h}{\omega_l} \right)^{\frac{k+N+0.5(1-q)}{2N+1}} \\
 \omega_k &= \omega_l \left( \frac{\omega_h}{\omega_l} \right)^{\frac{k+N+0.5(1+q)}{2N+1}}
 \end{aligned} \tag{6}$$

### 3. PID controllers

Consider the block diagram of a single loop feedback control system of Figure 2,  $P(s)$  is the process plant,  $C(s)$  is a controller,  $D(s)$  and  $N(s)$  are external disturbance and noise respectively [1, 30–34]. In the figure,  $R(s)$  is the reference signal,  $Y(s)$  is the output signal and  $E(s)$  is the error signal given as

$$E(s) = R(s) - (Y(s) + N(s)). \tag{7}$$

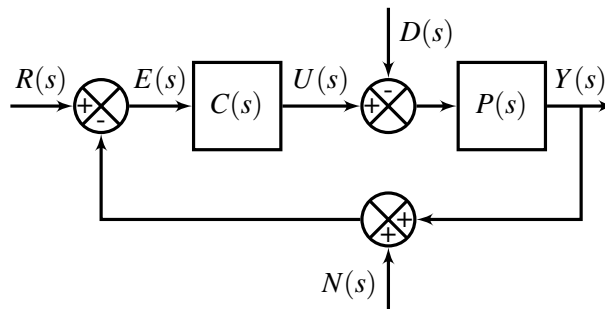

Figure 2: General closed loop block diagram of a control system

Assuming the controller  $C(s)$  is a PID controller that is widely used in process industries [6, 35–39] for the control of temperature, flow, level, pressure, pH, etc. The main objectives of such controller is [1, 40]:

- To keep  $Y(s)$  as close to  $R(s)$  (i.e., set-point tracking).
- To ensure  $Y(s)$  follows variations in  $R(s)$  (i.e., variable set-point tracking or servo-control).
- To ensure quick recovery of  $Y(s)$  from effect of  $D(s)$  (i.e., disturbance rejection or regulatory control).
- To generate  $U(s)$  that is free from undesired oscillations and immune to  $N(s)$  (i.e., smoother control action).

The PID controller comes in different forms such as standard (or textbook), ideal, parallel (or independent) and industrial (or interacting or series) [3, 6, 31, 36]. The control action of these structures and the conversion formula to get the controller parameters from one specific PID form to another is given in the subsequent subsections.

### 3.1. Standard PID controller

The control action of standard or textbook version of PID controller is given as

$$U(s) = K_p \left( 1 + \frac{1}{T_i s} + \frac{T_d s}{\alpha T_d s + 1} \right) E(s), \quad (8)$$

where

- $K_p$  is proportional gain,
- $T_i$  is integral time constant,
- $T_d$  is derivative time constant and
- $\alpha$  is the derivative filter constant.

Thus, we denote the controller parameters as  $\theta_{cp} = \{K_p, T_i, T_d \text{ \& } \alpha\}$ . The block diagram of the PID based on (8) is shown in Figure 3. The list of possible controllers obtainable from (8) are given in Table 1 [41]. For  $\alpha = 0$ , the standard PID reduces to ideal PID with control action given as follows

$$U(s) = K_p \left( 1 + \frac{1}{T_i s} + T_d s \right) E(s). \quad (9)$$

Table 1: PID control family

Controller	Control signal ( $U(s)$ )	Controller parameters ( $\theta_{cp}$ )
P	$K_p E(s)$	$K_p$
I	$\frac{1}{T_i s} E(s)$	$T_i$
D	$\left( \frac{T_d s}{\alpha T_d s + 1} \right) E(s)$	$T_d \text{ \& } \alpha$
PI	$K_p \left( 1 + \frac{1}{T_i s} \right) E(s)$	$K_p \text{ \& } T_i$
PD	$K_p \left( 1 + \frac{T_d s}{\alpha T_d s + 1} \right) E(s)$	$K_p, T_d \text{ \& } \alpha$

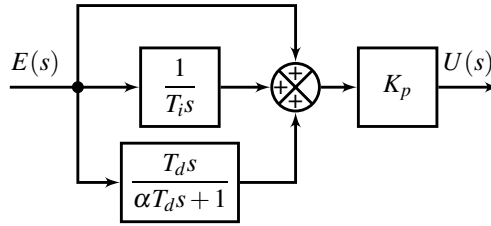

Figure 3: Standard PID controller structure

### 3.2. Ideal PID controller with filter

The control action of an ideal PID controller with external filter is given as

$$U(s) = K_p^* \left( 1 + \frac{1}{T_i^* s} + T_d^* s \right) \left( \frac{1}{T_f s + 1} \right) E(s), \quad (10)$$

where  $T_f$  is the filter time constant.

Thus, the controller parameters  $\theta_{cp} = \{K_p^*, T_i^*, T_d^* \& T_f\}^1$ . The implementation of PID based on (10) is shown in Figure 4. The filter is essentially to filter the control signal of the ideal PID [6, 42–44].

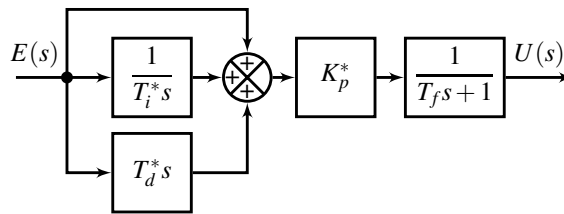

Figure 4: Ideal PID controller structure with filter

### 3.3. Parallel PID controller

The control action of parallel or independent PID controller is given as

$$U(s) = \left( K_p + \frac{K_i}{s} + \frac{K_d s}{\alpha_p K_d s + 1} \right) E(s), \quad (11)$$

where

- $K_p$  proportional gain,
- $K_i$  integral gain,

<sup>1</sup>The \* notation is to differentiate the various parameters of PID and it is for analysis purpose only.

- $K_d$  is derivative gain and
- $\alpha_p$  is the derivative filter constant.

It should be noted that, unlike the standard PID where the  $K_p$  appears in all actions, here,  $K_p$  is independent of integral and derivative actions. Therefore, the controller parameters is given as  $\theta_{cp} = \{K_p, K_i, K_d \& \alpha_p\}^2$ . The implementation of (11) is shown in Figure 5.

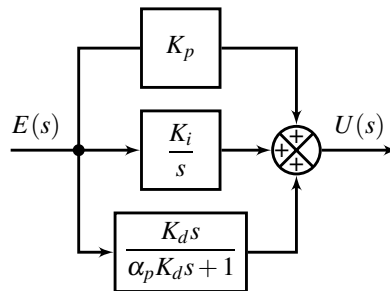

Figure 5: Parallel PID controller structure

### 3.4. Industrial PID controller

The control action of industrial or interacting or series PID controller is given as

$$U(s) = K'_p \left( 1 + \frac{1}{T'_i s} \right) \left( \frac{T'_d s + 1}{\alpha' T'_d s + 1} \right) E(s). \quad (12)$$

In (12), it can be seen that this type of controller is synonymous to having PI and PD in series for easy implementation in industry. Thus, the controller parameters is given as  $\theta_{cp} = \{K'_p, T'_i, T'_d \& \alpha'\}^3$ . The implementation of PID based on (12) is shown in Figure 6.

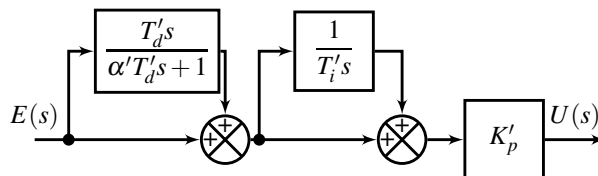

Figure 6: Industrial PID controller structure

<sup>2</sup>The  $_p$  notation for parallel is used to differentiate the various parameters of PID and it is for analysis purpose only.

<sup>3</sup>The  $'$  notation is to differentiate the various parameters of PID and it is for analysis purpose only.



**3.5. Conversion of one PID form to another**

The conversion of one PID form to another including formulas is given in Figure 7 [3, 6, 45, 46]. In the figure,  $F$  denotes the conversion factor and all the conversions are based on standard PID structure. Furthermore, it can also be seen from the figure that the conversion from ideal PID to standard PID holds if  $T_d^* > F^* T_f$ . Similarly, the conversion from standard to industrial and vice versa

is only possible if  $1 - \frac{(4 + 2\alpha)T_d}{T_i} + \frac{\alpha^2 T_d^2}{T_i^2} > 0$  and  $\alpha' < 1 + \frac{T_i'}{T_d'}$  respectively.

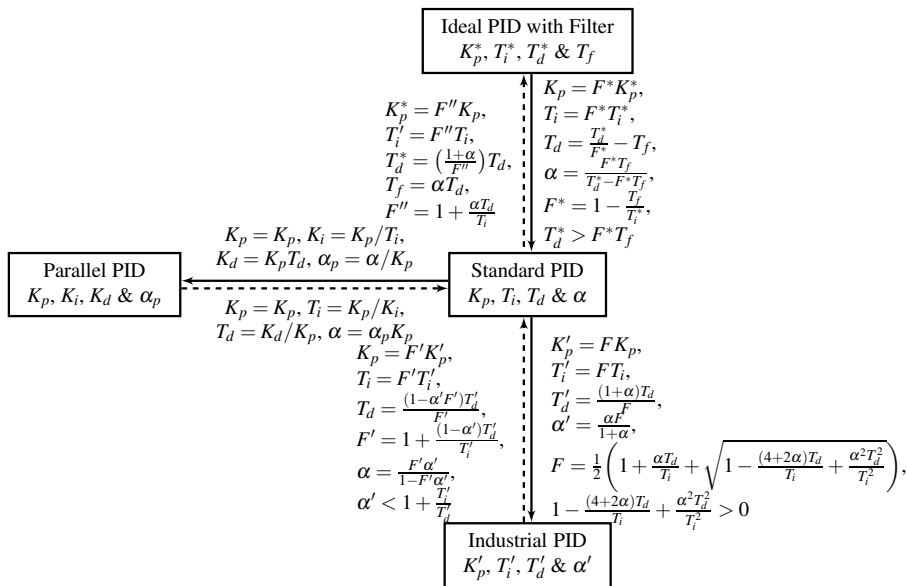

Figure 7: Conversion of PID controller parameters

**4. 2DOF PID controllers**

In this section, the 2DOF versions of PID controllers given in Section 3 are derived. The section will also give the conversion formula for converting one form of 2DOF PID to another.

In PID controller, the proportional and derivative actions in the forward paths causes rapid changes in the control signal during set-point change. These effects are called proportional and derivative kick effects [30–32, 34, 47, 48]. In order to avoid these effects, 2DOF PID or set-point weighted PID (SWPID) structures are used in the industry [49–60]. The advantage of these controllers is that they respond to set-point changes and load disturbances separately.

The four forms of 2DOF PID controllers [3, 6, 61, 62] are given below.

#### 4.1. Standard 2DOF PID controller

The control action of standard 2DOF PID controller is achieved by weighting the reference signal of the proportional and derivative actions of standard PID in (8) as follows

$$U(s) = K_p \left( E_p(s) + \frac{1}{T_i s} E_i(s) + \frac{T_d s}{\alpha T_d s + 1} E_d(s) \right). \quad (13)$$

The error terms associated with each of the proportional, integral and derivative actions of (13) are given as follows:

$$E_p(s) = bR(s) - Y(s), \quad (14)$$

$$E_i(s) = R(s) - Y(s), \quad (15)$$

$$E_d(s) = cR(s) - Y(s), \quad (16)$$

where  $b$  and  $c$  are the proportional and derivative set-point weighting parameters respectively. These weights are both chosen between 0 and 1. As shown in (15), to avoid steady-state control error the error associated with the integral action is not weighted. Substituting (14), (15) and (16) in (13), the control action is written as

$$U(s) = K_p \left( b + \frac{1}{T_i s} + \frac{c T_d s}{\alpha T_d s + 1} \right) R(s) - K_p \left( 1 + \frac{1}{T_i s} + \frac{T_d s}{\alpha T_d s + 1} \right) Y(s). \quad (17)$$

Thus, 2DOF PID is synonymous to having two PID controllers; one for set-point tracking and the other for disturbance rejection. The block diagram implementation of (17) is given in Figure 8. Here, for small values of  $b$  re-

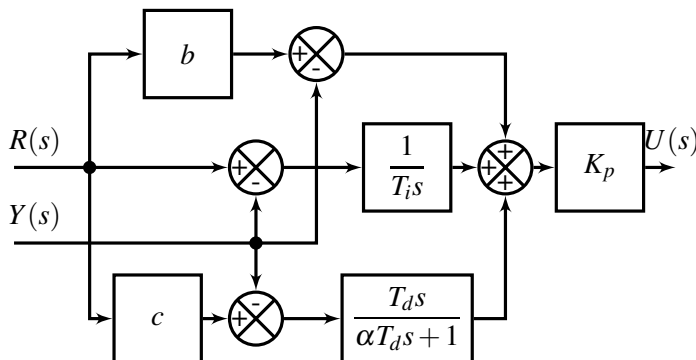

Figure 8: Standard 2DOF PID controller structure

duces overshoot but results in a slower response to set-point changes. Furthermore, the weight  $c$  is usually set to zero in order to avoid derivative kick effect [31, 32, 34, 47, 48]. In this case (17) reduces to

$$U(s) = K_p \left( b + \frac{1}{T_i s} \right) R(s) - K_p \left( 1 + \frac{1}{T_i s} + \frac{T_d s}{\alpha T_d s + 1} \right) Y(s). \quad (18)$$

Therefore, (18) is implemented in a closed loop control structure of Figure 9.

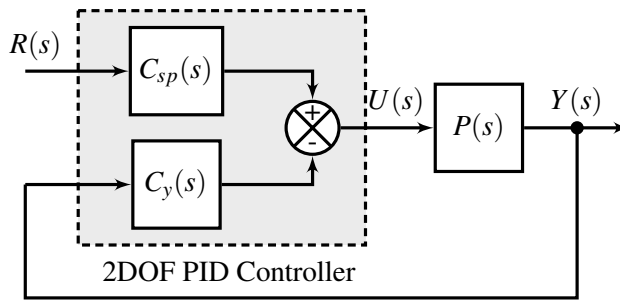

Figure 9: Implementation of 2DOF PID controller

The parameters of this 2DOF PID controller are now  $\theta_{cp} = \{K_p, T_i, T_d, \alpha, b$  and  $c = 0\}$ . In the figure,  $C_{sp}(s)$  and  $C_y(s)$  are the respective controllers applied to  $R(s)$  for set-point tracking and  $Y(s)$  for disturbance rejection given as

$$C_{sp}(s) = K_p \left( b + \frac{1}{T_i s} \right), \quad (19)$$

$$C_y(s) = K_p \left( 1 + \frac{1}{T_i s} + \frac{T_d s}{\alpha T_d s + 1} \right). \quad (20)$$

#### 4.2. Ideal 2DOF PID controller with filter

The control action of an ideal 2DOF PID controller with external filter derived from (10) is given as

$$\begin{aligned}
 U(s) = & K_p^* \left( b^* + \frac{1}{T_i^* s} + c^* T_d^* s \right) \left( \frac{1}{T_f s + 1} \right) R(s) \\
 & - K_p^* \left( 1 + \frac{1}{T_i^* s} + T_d^* s \right) \left( \frac{1}{T_f s + 1} \right) Y(s). \quad (21)
 \end{aligned}$$

The reduced form of the controller i.e. for  $c^* = 0$ ,

$$U(s) = K_p^* \left( b^* + \frac{1}{T_i^* s} \right) \left( \frac{1}{T_f s + 1} \right) R(s) - K_p^* \left( 1 + \frac{1}{T_i^* s} + T_d^* s \right) \left( \frac{1}{T_f s + 1} \right) Y(s). \quad (22)$$

Figure 9 can also be used for implementation of (22) with parameters  $\theta_{cp} = \{K_p^*, T_i^*, T_d^*, T_f, b^*$  and  $c^* = 0\}$  in a similar way to the earlier considered standard 2DOF PID. Thus, the controllers  $C_{sp}(s)$  and  $C_y(s)$  are given as

$$C_{sp}(s) = K_p^* \left( b^* + \frac{1}{T_i^* s} \right) \left( \frac{1}{T_f s + 1} \right), \quad (23)$$

$$C_y(s) = K_p^* \left( 1 + \frac{1}{T_i^* s} + T_d^* s \right) \left( \frac{1}{T_f s + 1} \right). \quad (24)$$

A key difference between  $C_{sp}(s)$  and  $C_y(s)$  of standard 2DOF PID and the ideal 2DOF PID is that in the former, the filter action is inbuilt with derivative action while in the latter, the filter action is implemented through external filter.

### 4.3. Parallel 2DOF PID controller

In the same vein, the control action of parallel 2DOF PID controller derived from (11) is given as

$$U(s) = \left( b_p K_p + \frac{K_i}{s} + \frac{c_p K_d s}{\alpha_p K_d s + 1} \right) R(s) - \left( K_p + \frac{K_i}{s} + \frac{K_d s}{\alpha_p K_d s + 1} \right) Y(s). \quad (25)$$

For  $c_p = 0$ , (25) is reduced to

$$U(s) = \left( b_p K_p + \frac{K_i}{s} \right) R(s) - \left( K_p + \frac{K_i}{s} + \frac{K_d s}{\alpha_p K_d s + 1} \right) Y(s). \quad (26)$$

Similarly, the controller is implemented using Figure 9 with controller parameters  $\theta_{cp} = \{K_p, K_i, K_d, \alpha_p, b_p$  and  $c_p = 0\}$ . Thus, the controllers  $C_{sp}(s)$  and  $C_y(s)$  are given as

$$C_{sp}(s) = b_p K_p + \frac{K_i}{s}, \quad (27)$$

$$C_y(s) = K_p + \frac{K_i}{s} + \frac{K_d s}{\alpha_p K_d s + 1}. \quad (28)$$

The set-point weighting parameters of various controllers derived from (25) are given in Table 2 [54]. Graphically, the relationship between these controllers can be shown on  $b - c$  plane in Figure 10.

Table 2: Parameters of various controllers derived from (25)

Controller	$b$	$c$
I-PD	0	0
ID-P	0	1
PI-D	1	0
PID	1	1
PI-PD	$0 < b < 1$	0

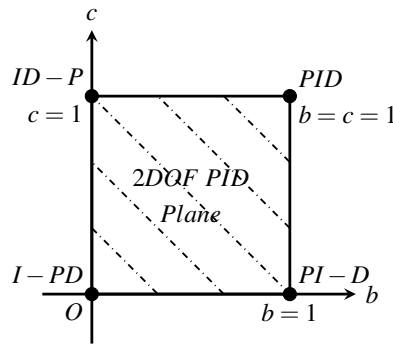
Figure 10: Graphical representation of 2DOF PID controllers on  $b - c$  plane

#### 4.4. Industrial 2DOF PID controller

The 2DOF industrial PID can be derived in a similar way to all other controller. Thus, the control action of this controller based on (12) is given as

$$\begin{aligned}
 U(s) = & K_p' \left( b' + \frac{1}{T_i' s} \right) \left( \frac{c' T_d' s + 1}{\alpha' c' T_d' s + 1} \right) R(s) \\
 & - K_p' \left( 1 + \frac{1}{T_i' s} \right) \left( \frac{T_d' s + 1}{\alpha' T_d' s + 1} \right) Y(s). \quad (29)
 \end{aligned}$$

The same assumption of  $c' = 0$  is done here. Thus, the reduced form of the controller is given in (30) while Figure 9 is used for its implementation. Consequently, the parameters of the controller are given as  $\theta_{cp} = \{K_p', T_i', T_d', \alpha', b'$  and  $c' = 0\}$ .

$$U(s) = K_p' \left( b' + \frac{1}{T_i' s} \right) R(s) - K_p' \left( 1 + \frac{1}{T_i' s} \right) \left( \frac{T_d' s + 1}{\alpha' T_d' s + 1} \right) Y(s). \quad (30)$$

Now, breaking the controller into its  $C_{sp}(s)$  and  $C_y(s)$  as in the other controllers gives (31) and (32) respectively.

$$C_{sp}(s) = K'_p \left( b' + \frac{1}{T'_i s} \right), \quad (31)$$

$$C_y(s) = K'_p \left( 1 + \frac{1}{T'_i s} \right) \left( \frac{T'_d s + 1}{\alpha' T'_d s + 1} \right). \quad (32)$$

#### 4.5. Conversion of One 2DOF PID Form to Another

The relationships for converting the proportional set-point weighting parameter  $b$  from one specific structure of 2DOF PID to another is shown in Figure 11. It can be seen from the figure that in order to avoid derivative kick effect,  $c$  is set to zero for all configurations. The conversions factors  $F$  are available in Figure 7.

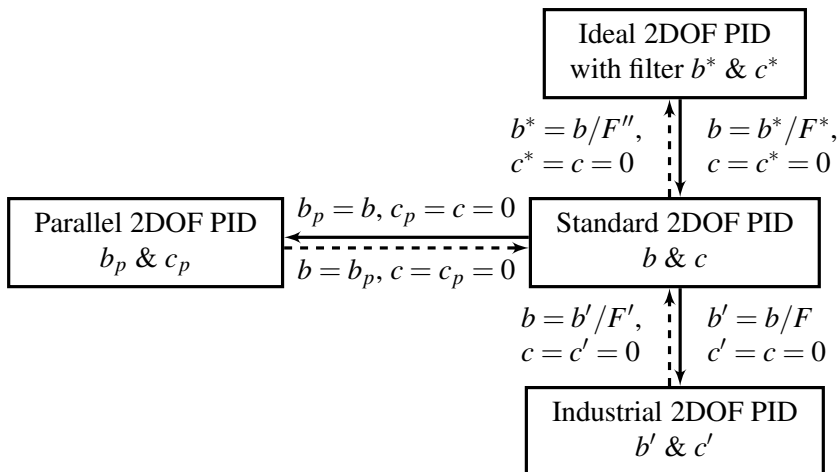

Figure 11: Conversion of 2DOF PID controller parameters

#### 4.6. Books related to 2DOF PID controllers

Up to this moment, there is no single reported book specifically dedicated to 2DOF PID controllers only. However, topics relating to these controllers are covered extensively as part of general books on PID controllers. Thus, in order to fully understand 2DOF PID one will have to consult these general books. Here, we summarize the content of some of these books in Table 3.

Table 3: Books related to 2DOF PID controllers

No.	Title	Topics	Ref
1	Advanced PID Control	Set-point weighting Feedforward design PI-PD controller structure	[34]
2	PID Controllers for Time Delay Systems	PI-PD controller structure	[63]
3	Practical PID Control	Constant, variable and fuzzy set-point weighting Causal and noncausal feedforward action	[31]
4	Control of Dead-time Processes	2DOF forms of PID, smith predictor and IMC Filter configuration of 2DOF PID controller	[64]
5	Control of Integral Processes with Dead Time	Noncausal feedforward action for continuous and discrete time systems PI-PD control structure Filter configuration of 2DOF PID controller Robust stability analysis	[65]
6	Feedback Systems: An Introduction for Scientists and Engineers	Set-point Weighting Cruise control with set-point weighting of PID controllers based on operational amplifiers	[66]
7	PID Control in the Third Millennium: Lessons Learned and New Approaches	Set-point weighting PID (SWPID) controllers unstable systems Robustness in SWPID controllers Feedforward, feedback and filter configurations of 2DOF PID controllers	[32]
8	Model-Reference Robust Tuning of PID Controllers	2DOF PID controllers structures 2DOF PID controllers for integrating, overdamped and unstable processes Model reference robust tuning of 2DOF PID controllers	[6]
9	PID Controller Tuning Using Magnitude Optimum Criterion	Filter configuration of 2DOF PID controller Robust tuning of 2DOF PID controllers using magnitude optimum criterion	[67]

## 5. FOPID controllers

The FOPID (or  $PI^\lambda D^\mu$ ) controller is an extension of classical or integer-order PID discussed in Section 3. The FOPIDs have advantages of being robust and stable even with varying process parameters. The FOPID performs better

especially for higher order systems characterized by high nonlinearities and delays [2, 19, 28, 29, 68–70]. Another benefit of using the controller is that it can attain the property of iso-damping<sup>4</sup> easily. Thus, this section discusses the fractional order forms of the controllers presented in Section 3. Furthermore, MATLAB based simulation toolboxes as well as books relating to FOPID will be briefly discussed.

### 5.1. FOPID controller structures

The control action of standard FOPID controller is obtained by replacing the integer-order of the integral and derivative actions of (8) with fractional orders  $\lambda$ ,  $\mu$  as follows

$$U(s) = K_p \left( 1 + \frac{1}{T_i s^\lambda} + \frac{T_d s^\mu}{\alpha T_d s^\mu + 1} \right) E(s), \quad (33)$$

where  $\lambda$ ,  $\mu \geq 0$  are the order of integration and derivation respectively.

The  $\lambda$  and  $\mu$  parameters of various forms of FOPID controllers derived from (33) are given in Table 4. The relationship between these controllers can be shown graphically on a  $\lambda - \mu$  plane in Figure 12.

Table 4: Parameters of various controllers derived from (33)

Controller	$\lambda$	$\mu$
P	0	0
PI	1	0
PD	0	1
PID	1	1
FOPI	$0 < \lambda < 1$	0
FOPD	0	$0 < \mu < 1$
FOPID	$0 < \lambda < 1$	$0 < \mu < 1$

Similarly, the control actions of ideal, parallel and industrial FOPID controllers also derived from Eqs (10), (11) and (12) are given as follows:

$$U(s) = K_p^* \left( 1 + \frac{1}{T_i^* s^\lambda} + T_d^* s^\mu \right) \left( \frac{1}{T_f s + 1} \right) E(s), \quad (34)$$

<sup>4</sup>A desirable property of the system referring to a state where the open-loop phase Bode plot is flat



$$U(s) = \left( K_p + \frac{K_i}{s^\lambda} + \frac{K_d s^\mu}{\alpha_p K_d s^\mu + 1} \right) E(s), \quad (35)$$

$$U(s) = K'_p \left( 1 + \frac{1}{T'_i s^\lambda} \right) \left( \frac{T'_d s^\mu + 1}{\alpha' T'_d s^\mu + 1} \right) E(s). \quad (36)$$

The difference between the controller parameters  $\theta_{cp}$  of the FOPID and PID controllers is addition of fractional order terms  $\lambda$  and  $\mu$ .

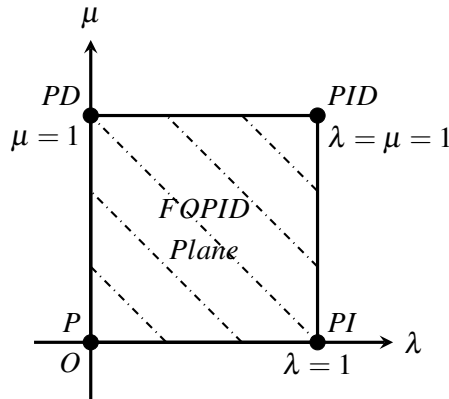

Figure 12: Graphical representation of FOPID controllers on  $\lambda - \mu$  plane

Other forms of FOPID controller besides the reported forms here are available in the literature. Example of such controllers include Fractional order PI-PD [71–73], FO[PI] and FO[PD] [74], IMC based FOPID [75, 76], Modified FO-PID with filter [77, 78] and Nonlinear FOPID [79, 80].

## 5.2. MATLAB Based Toolboxes and Books for FOPID Controller

For the implementation of FOPID controller, there are many MATLAB based toolboxes are available in the literature. The most used among these toolboxes are summarized in Table 5. A more detailed survey on these toolboxes can be found in [2, 18]. Meanwhile, the related books on FOPID controllers including topics are summarized in Table 6.

Table 5: MATLAB based toolboxes for FOPID controllers

No.	Toolbox	Features	Ref
1	Commande robuste d'ordre non entier (CRONE)	Fractional order differentiation Fractional order differential systems Fractional order system identification Laplace transforms and inverse Laplace transforms Fractional order CRONE control	[27, 81, 82]
2	Ninteger	Approximation methods of fractional order derivative Graphical user interface for controller design Fractional order system identification Bode, Nyquist and Nichols plots	[83]
3	Fractional states-space toolkit	Fractional order approximation methods Step, Bode and Measurement noise plots Performance analysis and criteria	[84]
4	Sysquake interactive software tool	Analysis and design of FOPID controllers	[85]
5	Fractional order modeling and control (FOMCON)	Fractional order System Identification FOPID design, tuning and optimization tools Step, Bode, Nyquist and Nichols plots Implementation of FOPID in digital and analog Approximation methods for the fractional derivatives	[86–88]
6	Digital fractional order differentiator/integrator	Finite impulse response (FIR) type Infinite impulse response (IIR) type	[28, 69, 89]
7	FOPID tool	Tuning of FOPID controller Step, Bode, Nyquist and Nichols plots Approximation methods for fractional orders systems	[84]

Table 6: Books related to FOPID controllers

No.	Title	Topics	Ref
1	Linear Feedback Control: Analysis and Design with MATLAB	Fractional order calculus and its computations Frequency and time domain analysis of fractional order systems FOPID controller and its implementation using MATLAB Oustaloup's recursive filter approximation	[29]
2	Advances in Fractional Calculus: Theoretical Developments and Applications in Physics and Engineering	Fractional order derivatives Tuning of FOPID controllers Fractional order modeling and control of practical systems Implementation of FOPID on field programmable gate arrays (FPGA)	[90]
3	Fractional-order Systems and Controls: Fundamentals and Applications	Fundamentals of fractional order systems and control FOPID controllers for time delay systems Tuning of FOPID controllers MATLAB implementation for fractional order controllers Fractional order modelling and controller for real time applications	[19]
4	Fractional Order Systems: Modeling and Control Applications	Numerical methods for calculations of fractional order operators FOPID controller for delay systems Implementation of FOPID using FPGA Fractional order chaotic systems	[89]
5	Fractional Order Nonlinear Systems: Modeling, Analysis and Simulation	Fractional order nonlinear systems and its stability analysis Fractional order chaotic systems and its control	[28]
6	Fractional Dynamics and Control	Fractional model predictive control Neural network assisted FOPID control Fractional order modeling Stabilization of fractional order chaotic system	[91]
7	Intelligent Fractional Order Systems and Control: An Introduction	Tuning of fractional order controllers using optimization algorithms Gain and order scheduling of fractional order controllers Fractional order fuzzy PID controllers	[92]
8	Fractional Order Control Systems: Fundamentals and Numerical Implementations	Computation algorithms of fractional order operators Modelling and analysis of fractional order transfer function FOPID controller design and tuning for delay systems Design of fuzzy FOPID controllers	[93]
9	An Introduction to Fractional Control	Fractional calculus: real and complex order Fractional order PID, Fractional order reset control Fractional order H2 and H-infinity ( $H_\infty$ ) control Fractional order sliding mode control	[70]

## 6. 2DOF FOPID controllers

This section discusses the fractional order forms of 2DOF PID controllers presented in Section 4. Furthermore, the equivalent configurations of standard 2DOF FOPID as well as parameters of various controllers derived from 2DOF FOPID will be briefly discussed.

### 6.1. 2DOF FOPID controller structures

In this subsection, the various controller structures are developed based on our earlier work reported in [7].

#### 6.1.1. Standard 2DOF FOPID

The control action of standard 2DOF FOPID controller is obtained by replacing the integer-order integral and derivative actions of (13) with fractional orders  $\lambda$  and  $\mu$  as follows

$$U(s) = K_p \left( b + \frac{1}{T_i s^\lambda} + \frac{c T_d s^\mu}{\alpha T_d s^\mu + 1} \right) R(s) - K_p \left( 1 + \frac{1}{T_i s^\lambda} + \frac{T_d s^\mu}{\alpha T_d s^\mu + 1} \right) Y(s), \quad (37)$$

where the controller parameter term is given as  $\theta_{cp} = \{K_p, T_i, T_d, \alpha, b, c = 0, \lambda, \mu\}$ . As mentioned earlier,  $c$  is set to zero to avoid derivative kick effect. In this case, (37) reduces to

$$U(s) = K_p \left( b + \frac{1}{T_i s^\lambda} \right) R(s) - K_p \left( 1 + \frac{1}{T_i s^\lambda} + \frac{T_d s^\mu}{\alpha T_d s^\mu + 1} \right) Y(s) \quad (38)$$

Thus, (38) can be decomposed into two controllers  $C_{sp}(s)$  and  $C_y(s)$  are given as

$$C_{sp}(s) = K_p \left( b + \frac{1}{T_i s^\lambda} \right), \quad (39)$$

$$C_y(s) = K_p \left( 1 + \frac{1}{T_i s^\lambda} + \frac{T_d s^\mu}{\alpha T_d s^\mu + 1} \right). \quad (40)$$

#### 6.1.2. Ideal 2DOF FOPID with Filter

Similarly, the control action of ideal 2DOF FOPID with filter derived from (21) is given as follows

$$U(s) = K_p^* \left( b^* + \frac{1}{T_i^* s^\lambda} + c T_d^* s^\mu \right) \left( \frac{1}{T_f s + 1} \right) R(s) - K_p^* \left( 1 + \frac{1}{T_i^* s^\lambda} + T_d^* s^\mu \right) \left( \frac{1}{T_f s + 1} \right) Y(s), \quad (41)$$

where the controller parameters are  $\theta_{cp} = \{K_p^*, T_i^*, T_d^*, T_f, b^*$  and  $c^* = 0\}$ .

The reduced form of  $C_{sp}(s)$  and  $C_y(s)$  for  $c = 0$

$$C_{sp}(s) = K_p^* \left( b^* + \frac{1}{T_i^* s^\lambda} \right) \left( \frac{1}{T_f s + 1} \right), \quad (42)$$

$$C_y(s) = K_p^* \left( 1 + \frac{1}{T_i^* s^\lambda} + T_d^* s^\mu \right) \left( \frac{1}{T_f s + 1} \right) \quad (43)$$

### 6.1.3. Parallel 2DOF FOPID

In the same way as to standard and ideal 2DOF FOPID, the control action of parallel 2DOF FOPID derived from (25) is given as follows

$$U(s) = \left( b_p K_p + \frac{K_i}{s^\lambda} + \frac{c_p K_d s^\mu}{\alpha_p K_d s^\mu + 1} \right) R(s) - \left( K_p + \frac{K_i}{s^\lambda} + \frac{K_d s^\mu}{\alpha_p K_d s^\mu + 1} \right) Y(s). \quad (44)$$

The reduced form of  $C_{sp}(s)$  and  $C_y(s)$  for  $c = 0$

$$C_{sp}(s) = b_p K_p + \frac{K_i}{s^\lambda}, \quad (45)$$

$$C_y(s) = K_p + \frac{K_i}{s^\lambda} + \frac{K_d s^\mu}{\alpha_p K_d s^\mu + 1}, \quad (46)$$

where the controller parameters  $\theta_{cp} = \{K_p, K_i, K_d, \alpha_p, b_p, c_p = 0, \lambda, \& \mu\}$ . The effect of variation of these parameters on the steady state and transient response of the system is shown in Table 7 [5, 94].

Table 7: Effect of variation in controller parameters of parallel 2DOF FOPID

Parameter	Variation	Rise Time	Settling Time	Overshoot	Steady State Error	Stability
$K_p$	Increasing	Reduces	Minor Change	Increases	Reduces	Degrades
$K_i$	Increasing	Reduces	Increases	Increases	Eliminates	Degrades
$K_d$	Increasing	Minor Change	Reduces	Reduces	Minor Change	Improves
$b$	Decreasing	Increases	Minor Change	Reduces	Eliminates	Improves
$\lambda$	Decreasing	Minor Change	Increases	Reduces	Increases	Degrades
$\mu$	Decreasing	Minor Change	Increases	Reduces	Minor Change	Improves

#### 6.1.4. Industrial 2DOF FOPID

The control action of industrial 2DOF FOPID controller derived from (25) for an assumption of  $c = 0$  is given as follows

$$U(s) = K_p' \left( b' + \frac{1}{T_i' s^\lambda} \right) R(s) - K_p' \left( 1 + \frac{1}{T_i' s^\lambda} \right) \left( \frac{T_d' s^\mu + 1}{\alpha' T_d' s^\mu + 1} \right) Y(s), \quad (47)$$

where the controller parameters  $\theta_{cp} = \{K_p', T_i', T_d', \alpha', b', c' = 0, \lambda, \& \mu\}$ . From (47), the controllers  $C_{sp}(s)$  and  $C_y(s)$  are given as

$$C_{sp}(s) = K_p' \left( b' + \frac{1}{T_i' s^\lambda} \right), \quad (48)$$

$$C_y(s) = K_p' \left( 1 + \frac{1}{T_i' s^\lambda} \right) \left( \frac{T_d' s^\mu + 1}{\alpha' T_d' s^\mu + 1} \right). \quad (49)$$

## 6.2. Equivalent forms of 2DOF FOPID controllers

### 6.2.1. Standard form

The implementation of 2DOF PID controller shown in Figure 9 is similar to the implementation of 2DOF FOPID. The difference between the two is that the former is an integer-order while the latter is a fractional order. This type of implementation, is a two input and one output controller which can be decomposed into  $C_{sp}(s)$  and  $C_y(s)$  controllers. However, these type of the structure is not the only form that the 2DOF PID and 2DOF FOPID controllers can take. There are other configurations such as feedforward, feedback, pre-filter and component separated type [4, 32, 52, 54, 61, 95–98]. These additional configurations take the form of single input single output (SISO) controllers as explained subsequently. Here, only the 2DOF FOPID will be considered since it has similar structure with the 2DOF PID.

### 6.2.2. Feedforward configuration

In feedforward configuration, the 2DOF FOPID controller is decomposed into a FOPID controller  $C(s)$  and a fractional order feedforward controller  $C_f(s)$  as shown in Figure 13. The corresponding equations for these controllers are given as

$$C(s) = K_p \left( 1 + \frac{1}{T_i s^\lambda} + \frac{T_d s^\mu}{\alpha T_d s^\mu + 1} \right), \quad (50)$$

$$C_f(s) = K_p \left( (b - 1) + \frac{(c - 1) T_d s^\mu}{\alpha T_d s^\mu + 1} \right). \quad (51)$$

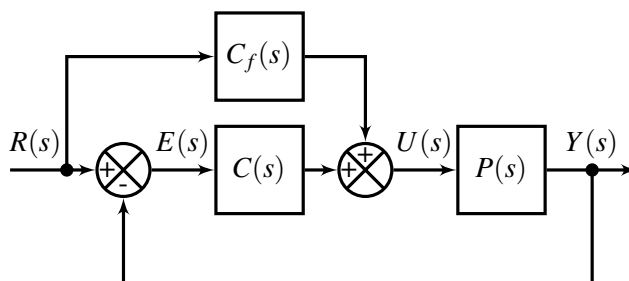

Figure 13: Feedforward type of 2DOF FOPID controller

For  $c = 0$ , (51) is reduced to

$$C_f(s) = K_p \left( (b - 1) - \frac{T_d s^\mu}{\alpha T_d s^\mu + 1} \right). \quad (52)$$

### 6.2.3. Feedback configuration

The 2DOF FOPID controller is decomposed into FOPID controller  $C(s)$  and a fractional order feedback controller  $C_b(s)$  in the feedback configuration as shown in Figure 14. Thus, the corresponding controller equations for  $c = 0$  are given as

$$C(s) = K_p \left( b + \frac{1}{T_i s^\lambda} \right), \quad (53)$$

$$C_b(s) = K_p \left( (1 - b) + \frac{T_d s^\mu}{\alpha T_d s^\mu + 1} \right). \quad (54)$$

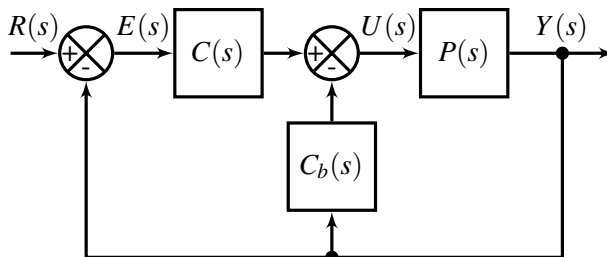

Figure 14: Feedback type of 2DOF FOPID controller

### 6.2.4. Pre-filter configuration

In this configuration, the 2DOF FOPID controller is decomposed into a FOPID controller  $C(s)$  and a fractional order pre-filter  $F(s)$  on the reference

signal as shown in Figure 15. From figure, the transfer functions of  $C(s)$  and  $F(s)$  for  $c = 0$  are given as

$$C(s) = K_p \left( 1 + \frac{1}{T_i s^\lambda} + \frac{T_d s^\mu}{\alpha T_d s^\mu + 1} \right), \tag{55}$$

$$F(s) = \frac{b\alpha T_i T_d s^{\lambda+\mu} + bT_i s^\lambda + \alpha T_d s^\mu + 1}{(\alpha + 1)T_i T_d s^{\lambda+\mu} + T_i s^\lambda + \alpha T_d s^\mu + 1}. \tag{56}$$

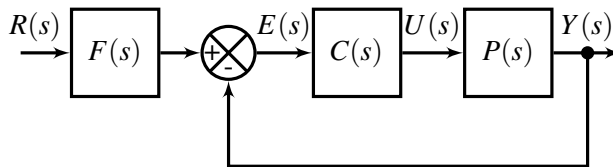

Figure 15: Pre-filter configuration of 2DOF FOPID

**6.2.5. Component separated type**

In component separated type, the proportional, integral and derivative actions are built separately as shown in Figure 16 [54, 58]. From figure, the controllers  $C_{sp}(s)$  and  $C_y(s)$  are given as

$$C_{sp}(s) = K_p \left( (1 - \alpha) + \frac{1}{T_i s^\lambda} + (1 - \beta) \frac{T_d s^\mu}{T_f s^\mu + 1} \right), \tag{57}$$

$$C_y(s) = K_p \left( 1 + \frac{1}{T_i s^\lambda} + \frac{T_d s^\mu}{T_f s^\mu + 1} \right), \tag{58}$$

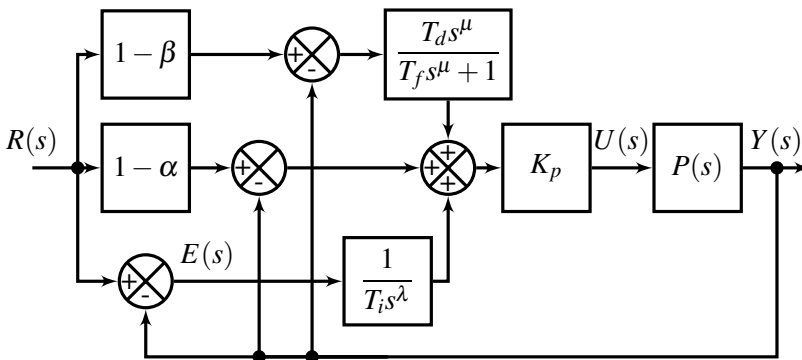

Figure 16: Component-separated type of 2DOF FOPID controller



where  $\alpha$  and  $\beta$  are the proportional and derivative set-point weighting parameters respectively. In order to avoid steady state error,  $\beta$  is set to one. Thus, the controller parameters are  $\theta_{cp} = \{K_p, T_i, T_d, T_f, \alpha, \lambda, \mu \text{ and } \beta = 1\}$ . In this case  $C_{sp}(s)$  is reduced to

$$C_{sp}(s) = K_p \left( (1 - \alpha) + \frac{1}{T_i s^\lambda} \right). \quad (59)$$

### 6.3. Parameters of various controller configurations

A summary of the parameters of various controllers derived from (37) is given in Table 8 [2, 7, 54]. Likewise, the graphical representation of these 2DOF FOPID controllers on a  $b - c$  plane are shown in Figure 17.

Table 8: Parameters of various controllers derived from (37)

Controller	Type	$b$	$c$	$\lambda$	$\mu$
PID	P	1	1	0	0
	PI	1	1	1	0
	PD	1	1	0	1
	PID	1	1	1	1
	I-PD	0	0	1	1
	ID-P	0	1	1	1
	PI-D	1	0	1	1
	PI-PD	$0 < b < 1$	1	1	1
2DOF PID	2DOF PD	$0 < b < 1$	$0 < c < 1$	0	1
	2DOF PI	$0 < b < 1$	$0 < c < 1$	1	0
	2DOF PID	$0 < b < 1$	$0 < c < 1$	1	1
	2DOF PI-D	$0 < b < 1$	0	1	1
FOPID	FOI-PD	0	0	$0 < \lambda < 1$	$0 < \mu < 1$
	FOID-P	0	1	$0 < \lambda < 1$	$0 < \mu < 1$
	FOPI-D	1	0	$0 < \lambda < 1$	$0 < \mu < 1$
	FOPI-PD	$0 < b < 1$	0	$0 < \lambda < 1$	$0 < \mu < 1$
	FOPI	1	1	$0 < \lambda < 1$	0
	FOPD	1	1	0	$0 < \mu < 1$
	FOPID	1	1	$0 < \lambda < 1$	$0 < \mu < 1$
2DOF FOPID	2DOF FOPI-D	$0 < b < 1$	0	$0 < \lambda < 1$	$0 < \mu < 1$
	2DOF FOID-P	0	$0 < c < 1$	$0 < \lambda < 1$	$0 < \mu < 1$
	2DOF FOPID	$0 < b < 1$	$0 < c < 1$	$0 < \lambda < 1$	$0 < \mu < 1$

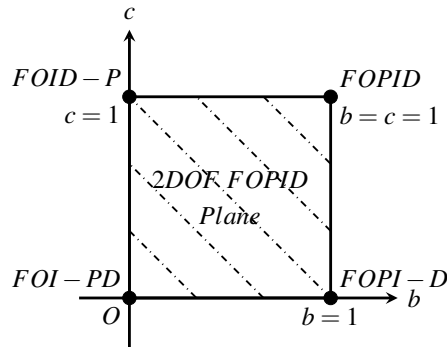

Figure 17: Graphical representation of 2DOF FOPID controllers on  $b - c$  plane

## 7. Results and discussions

In this section, to compare the performance of the various controllers discussed and their equivalent configurations, first, second and third order unstable systems as given in Table 9 are considered. These systems are reported in [54, 99–102] and [103]. The table summarizes the system parameters.

Table 9: Class of unstable systems considered for simulation

Transfer Function	Stable Poles	Unstable Poles	Dead Time
$G_1(s) = \frac{4}{4s-1}e^{-2s}$	–	0.25	2
$G_2(s) = \frac{1}{(2s-1)(0.5s+1)}e^{-s}$	–2	0.5	1
$G_3(s) = \frac{1}{(5s-1)(0.5s+1)(2s+1)}e^{-0.5s}$	–0.5, –2	0.2	0.5

For the first order system, comparison between ordinary PID controller structures will be given first. In the same way, the next comparison will be between 2DOF PID controllers. Then, another comparison between FOPID will be given. Subsequently, the comparison between 2DOF FOPID and equivalent configurations will also be given. Lastly, the standard configuration of each of the methods considered are compared. The PID parameters of the standard PID, as well as those of other controllers, obtained using conversion formulas in Figure 7 are given in Table 10. These parameters are used for all comparisons. Furthermore, in all cases, a disturbance ( $D(s)$ ) of 15% is injected at 100 sec. For the remaining

systems, the comparison between various standard form of the controllers will be given.

Table 10: Controller parameters of various PID configurations

Controller	Controller parameters ( $\theta_{cp}$ )			
Standard PID	$K_p = 0.4238$	$T_i = 30.9598$	$T_d = 0.4726$	$\alpha = 0.0254$
Parallel PID	$K_p = 0.4238$	$K_i = 0.0137$	$K_d = 0.2003$	$\alpha_p = 0.0600$
Industrial PID	$K'_p = 0.4172$	$T'_i = 30.4795$	$T'_d = 0.4922$	$\alpha' = 0.0244$
Ideal PID with Filter	$K_p^* = 0.4420$	$T_i^* = 30.9718$	$T_d^* = 0.4844$	$T_f = 0.0120$

## 7.1. UFOPDT

In this subsection, extensive comparison and analysis on the first order system is given. This is because many real time process dynamics can be adequately represented using first order system.

### 7.1.1. PID Controllers

The comparison of the response of the system with various controllers for set-point tracking and disturbance rejection is shown in Figure 18 while that

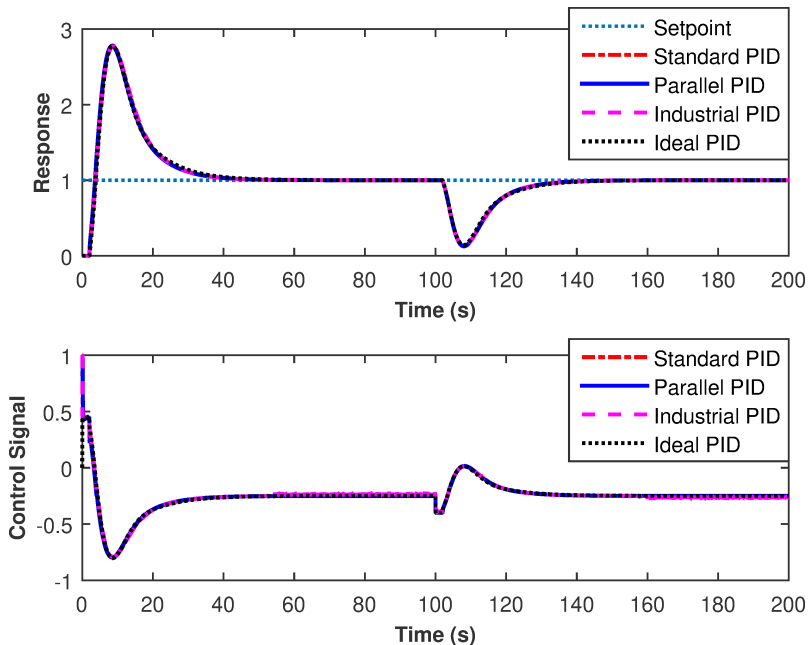

Figure 18: Set-point tracking and disturbance rejection performance comparison of various PID controllers

of variable set-point tracking is shown in Figure 19. From the figures, it can be observed that the responses are almost similar. Furthermore, the numerical assessment of Figure 18 given in Table 11 shows that the rise time ( $t_r$ ), settling time before and after the disturbance ( $t_{s1}$ ,  $t_{s2}$ ) and overshoot (%OS) of all the controllers are within a very small margin.

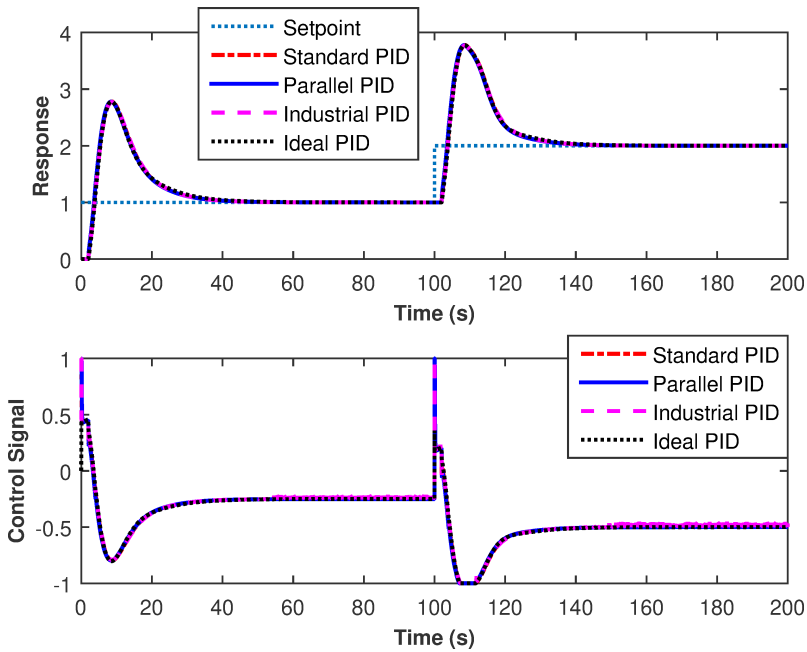

Figure 19: Variable set-point tracking performance comparison of various PID controllers

Table 11: Performance analysis of PID controllers

Controller	$t_r$	$t_{s1}$	$t_{s2}$	%OS
Standard PID	3.6992	38.7670	133.1913	178.1526
Parallel PID	<b>3.6189</b>	<b>38.5936</b>	133.1689	177.7878
Industrial PID	3.7464	38.7881	133.1943	<b>176.9530</b>
Ideal PID with Filter	3.7994	41.3460	<b>133.0575</b>	177.8186

### 7.1.2. 2DOF PID Controllers

The additional proportional set-point weighted parameter  $b$  for the standard 2DOF PID controller is 0.2558. The  $b$  parameter for other controllers derived using conversion formulas in Figure 11 are given in Table 12. As mentioned

earlier, the parameter  $c$  is set to zero in all cases to avoid derivative kick effect during set-point change.

Table 12: Set-point weighting parameter of various 2DOF PID configurations

Controller	$b$
Standard 2DOF PID	0.2558
Parallel 2DOF PID	0.2558
Industrial 2DOF PID	0.2598
Ideal 2DOF PID with Filter	0.2557

In a similar way to Section 7.1.1, the comparison of the response of the system with various controllers for set-point tracking with disturbance and variable set-point tracking are shown in Figure 20 and Figure 21 respectively. From both figures, it can be observed that the responses are almost similar except for the ideal case where it has less overshoot of 1.8413% and less settling time of 12.3565 s as compared to the around 5% and 17 s of other controllers (see Table 13). Furthermore, the control signals of all controllers for the two scenarios are almost similar. However, the only difference is that the control signal of the

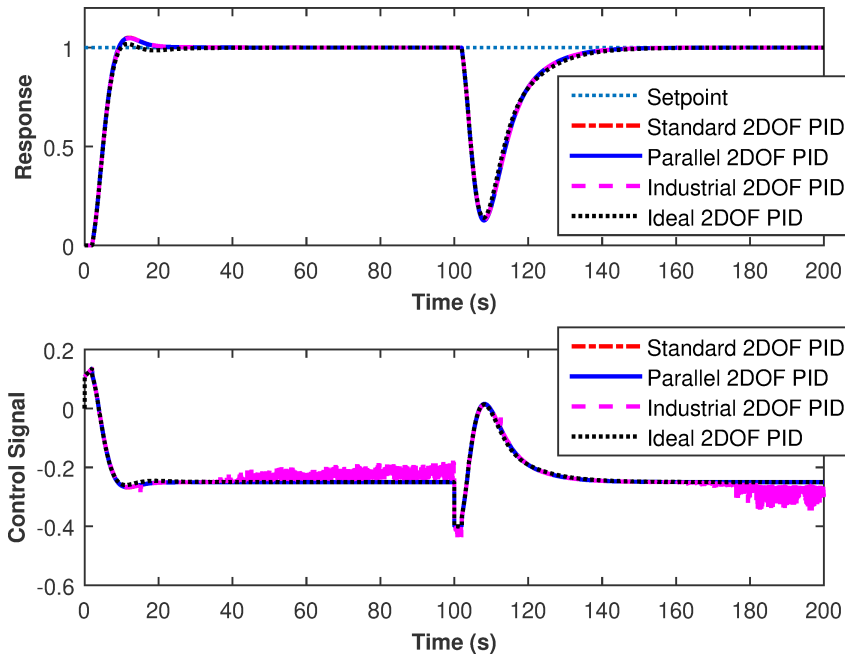

Figure 20: Set-point tracking and disturbance rejection performance comparison of various 2DOF PID controllers

industrial 2DOF PID signal is oscillatory. This is because the industrial PID is a series form that multiplies the effect of PI and PD. Thus, the noise amplification associated with the PD controller affects the final output. This type of structure is only used for its easy implementation not because it is better.

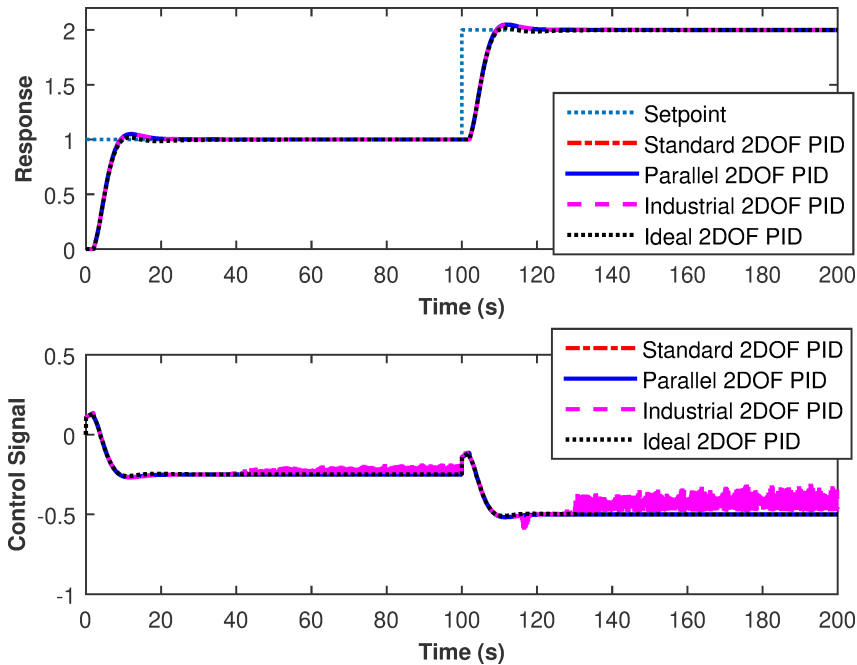

Figure 21: Variable set-point tracking performance comparison of various 2DOF PID controllers

Table 13: Performance analysis of 2DOF PID controllers

Controller	$t_r$	$t_{s1}$	$t_{s2}$	%OS
Standard 2DOF PID	4.9450	16.6458	137.5775	4.9966
Parallel 2DOF PID	4.9280	16.5741	137.5196	4.8496
Industrial 2DOF PID	5.0019	16.8929	137.5705	4.7265
Ideal 2DOF PID with Filter	5.0593	12.3565	139.9274	1.8413

### 7.1.3. FOPID controllers

The fractional order terms i.e.,  $s^\lambda$  and  $s^\mu$  are approximated using the refined Oustaloup method discussed in Sect. 2.3. The approximation parameters are  $a = 10$ ,  $b = 9$ ,  $\omega_l = 10^{-3}$ ,  $\omega_h = 10^3$  and  $N = 5$ . The fractional order parameters of

standard FOPID controller are  $\lambda = 0.98$  and  $\mu = 0.65$ . These values have been selected through MATLAB tuner and are used for all the FOPID variants.

In a similar fashion to Sections 7.1.1 and 7.1.2, the responses of the system with various controllers for set-point tracking and disturbance rejection are compared in Figure 22 while those of variable set-point tracking are shown in Figure 23. From the figures, it can be observed that the responses are almost similar to the other cases. Furthermore, the numerical assessment of Figure 22 given in Table 14 shows that the  $t_r$ ,  $t_{s1}$ ,  $t_{s2}$  and %OS of all the controllers are within a very small margin.

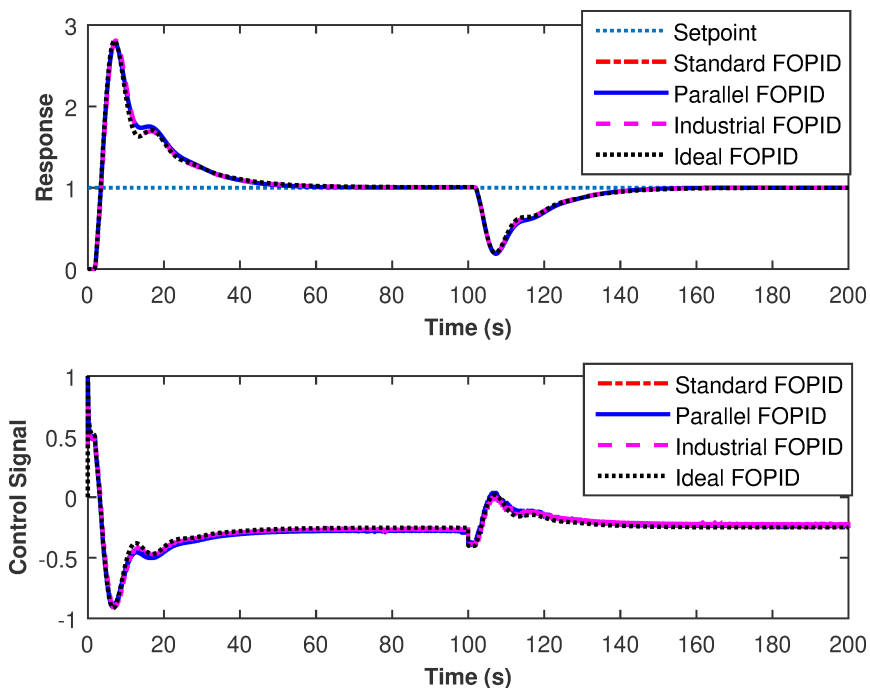

Figure 22: Set-point tracking and disturbance rejection performance comparison of various FOPID controllers

Table 14: Performance analysis of FOPID controllers

Controller	$t_r$	$t_{s1}$	$t_{s2}$	%OS
Standard FOPID	3.4294	48.3928	141.8261	176.8732
Parallel FOPID	3.4248	48.3528	141.7957	176.7757
Industrial FOPID	3.5302	50.3076	142.0789	180.2643
Ideal FOPID with Filter	3.3895	52.2939	143.4090	179.9968

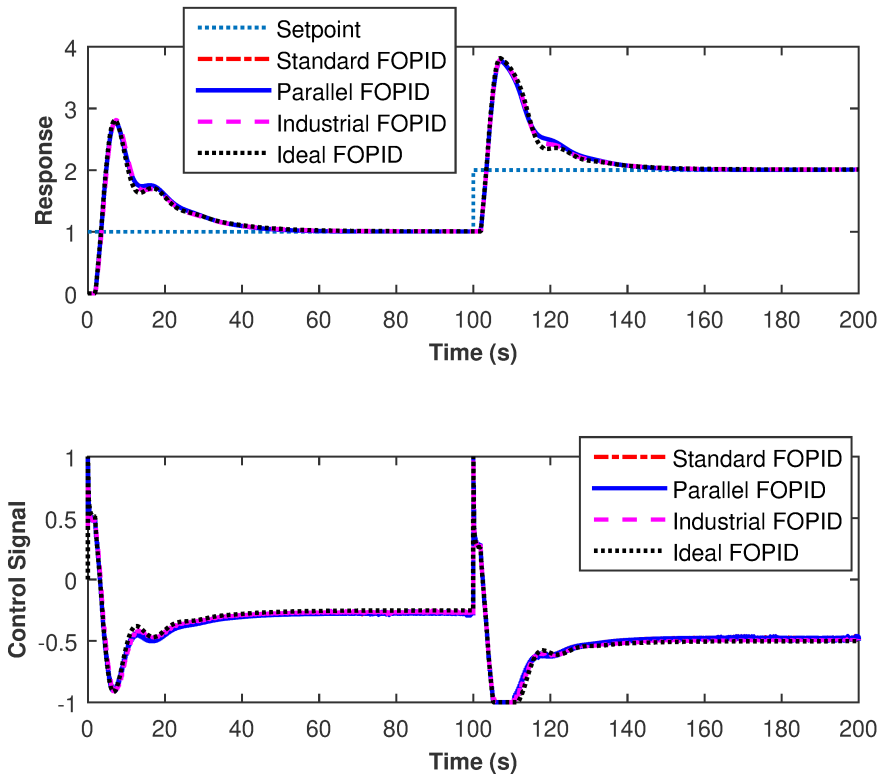

Figure 23: Variable set-point tracking performance comparison of various FOPID controllers

#### 7.1.4. 2DOF FOPID controllers

The controller parameters of Table 10 and 12 alongside fractional order parameters  $\lambda = 0.98$  and  $\mu = 0.65$  are used for simulation in this section.

Subsequently, the responses of the system with various controllers for set-point tracking and disturbance rejection are compared in Figure 24 while those of variable set-point tracking are shown in Figure 25. From the figures, it is observed that unlike in the previous cases, there is a slight difference in the respective responses. While both standard and parallel produced similar control signals and responses, the industrial and ideal configurations differ slightly with ideal producing the slowest response. This is further corroborated in Table 15. As shown in the table, the  $t_r$  of the industrial and ideal are 12.65 and 13.67 s respectively while the other two configurations are very close to each other at 5.15 and 5.16 s respectively. The %OS,  $t_{s1}$  and  $t_{s2}$  followed a similar pattern to the  $t_r$ .



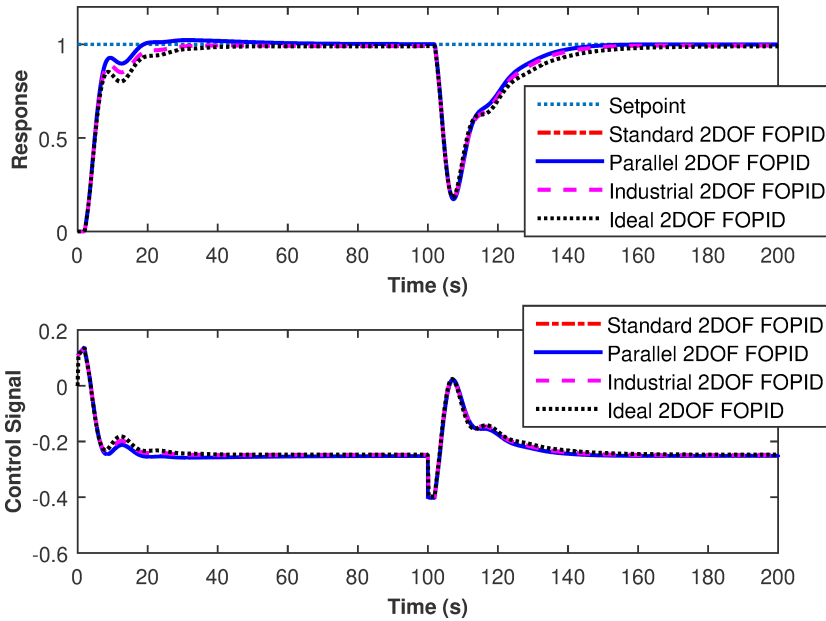

Figure 24: Set-point tracking and disturbance rejection performance comparison of various 2DOF FOPID controllers

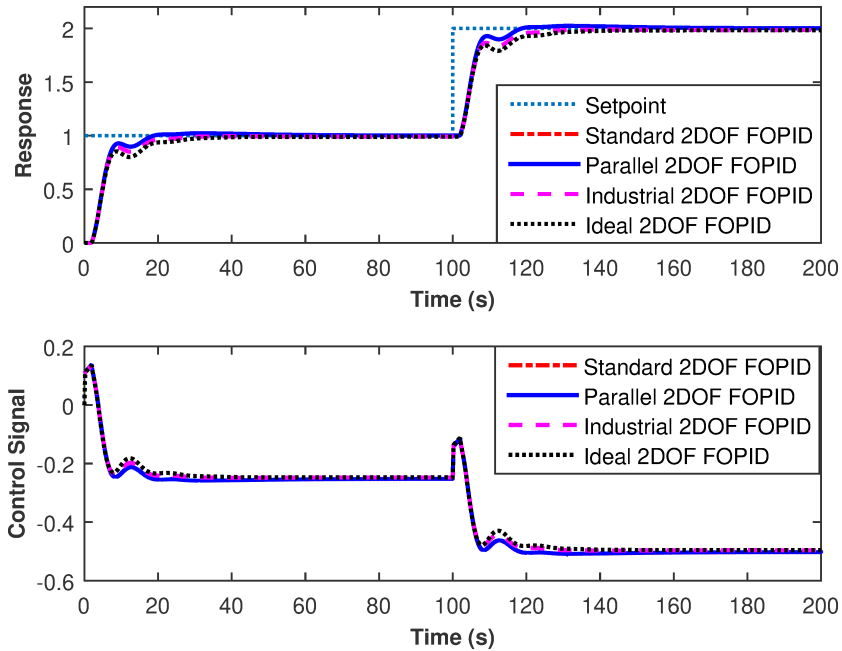

Figure 25: Variable set-point tracking performance comparison of various 2DOF FOPID controllers

Table 15: Performance analysis of 2DOF FOPID controllers

Controller	$t_r$	$t_{s1}$	$t_{s2}$	%OS
Standard 2DOF FOPID	5.1534	36.3904	141.6856	2.4008
Parallel 2DOF FOPID	5.1604	36.5544	141.6466	2.4145
Industrial 2DOF FOPID	12.6463	25.0293	143.6079	0.0630
Ideal 2DOF FOPID	13.6667	30.3422	151.2657	0.9903

### 7.1.5. Comparison between standard forms of PID, 2DOF PID, FOPID, 2DOF FOPID controllers

In this section, standard forms of all the controllers are compared. Similar controller parameters are used as in the previous sections i.e., parameters given in Table 10 and 12 alongside fractional order parameters  $\lambda = 0.98$  and  $\mu = 0.65$ .

The comparison of the responses of the system with various controllers for set-point tracking and disturbance rejection are given in Figure 26. From the figure, it can be clearly seen that the 2DOF based controllers (2DOF PID and 2DOF FOPID) produced responses with very little overshoots as compared to the PID and FOPID. This can be evaluated numerically by considering results in Table 16. The overshoot of the 2DOF based controllers ranges from 2 to 5%,

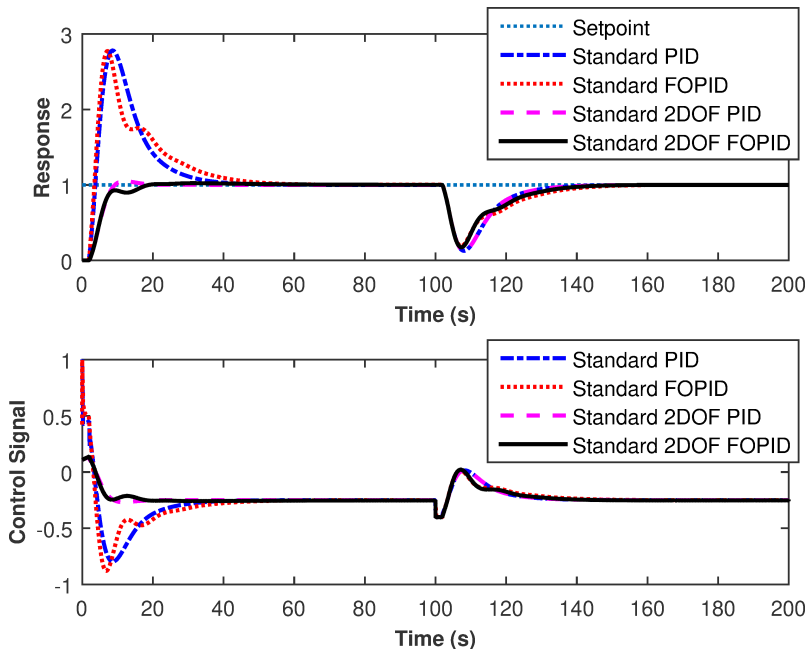

Figure 26: Set-point tracking and disturbance rejection performance comparison of various standard form of controllers

that of the other controllers ranges between 177 to 178%. While the 2DOF controllers have slower  $t_r$  of around 5 s each as compared to around 3.5 s of the PID and FOPID, they settled faster at 16.65 s for 2DOF PID and 36.40 s for 2DOF FOPID. The disturbance rejection of all controllers was found to be satisfactory with the standard PID having the fastest recovery with  $t_{s2}$  of 133.2 s. Furthermore, the 2DOF controllers produced smoother control signals to curtail the effect of overshoot.

Table 16: Performance analysis of various standard form of controllers

Controller	$t_r$	$t_{s1}$	$t_{s2}$	%OS
Standard PID	3.6992	38.7669	133.1913	178.1548
Standard FOPID	3.4294	48.3983	141.8285	177.5317
Standard 2DOF PID	4.9447	16.6453	137.5773	4.9966
Standard 2DOF FOPID	5.1534	36.3903	141.6856	2.4008

To evaluate the performance of various controllers to variation in reference signal, the plant is made to track variable set-point with various controllers as shown in Figure 27. From the responses, it can be observed during set-point

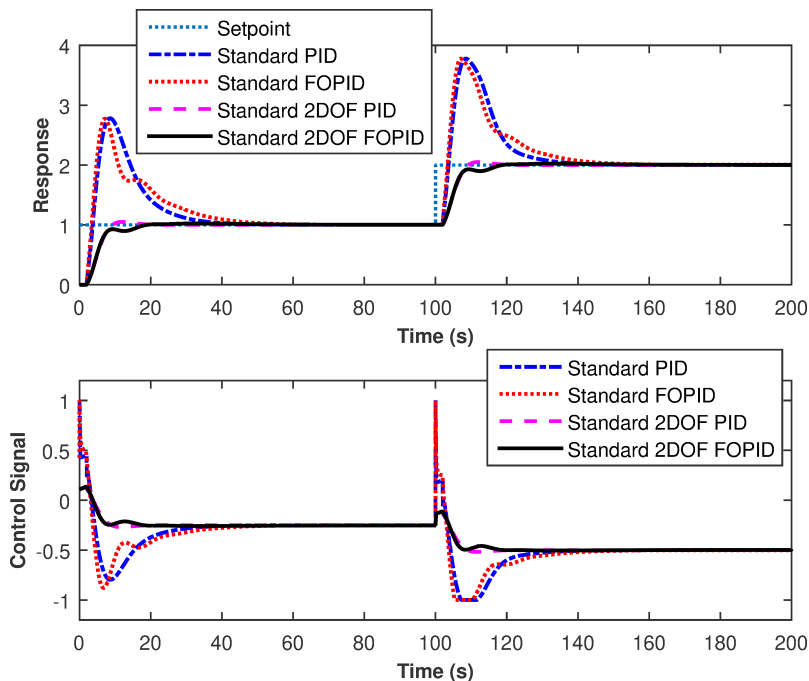

Figure 27: Variable set-point tracking performance comparison of various standard form of controllers

change (at 100 s), the PID and FOPID produced high overshoot while the 2DOF PID and 2DOF FOPID produced less overshoot. Observing the control signals of the controllers, it can be seen that the PID and FOPID have derivative kick effects. On the other hand, this effect is significantly reduced in the 2DOF PID and 2DOF FOPID controllers.

## 7.2. Unstable Second Order Plus Dead Time (USOPDT) System

Following similar fashion as to UFOPDT in Section 7.1.5, the tuned parameters of the standard PIDs compared are given in Table 17.

The comparison of the responses of the second order system with various standard form of PIDs for set-point tracking and disturbance rejection are given in Figure 28. Furthermore, numerical analysis of the performance of these controllers is given in Table 17. From both figure and table, it can be observed that the 2DOF based controllers (i.e., 2DOF PID and 2DOF FOPID) produced responses with very least overshoots of 0.2633 and 0.0005% as compared to the 187.7207 and 199.3169% of PID and FOPID respectively. While the 2DOF controllers have slower  $t_r$  of around 7 s each as compared to around 0.8 s of the PID and FOPID, they however settled faster at around 15 s compared to the respective 17.75 and 23.40 s of the PID and FOPID. Meanwhile, the disturbance rejection

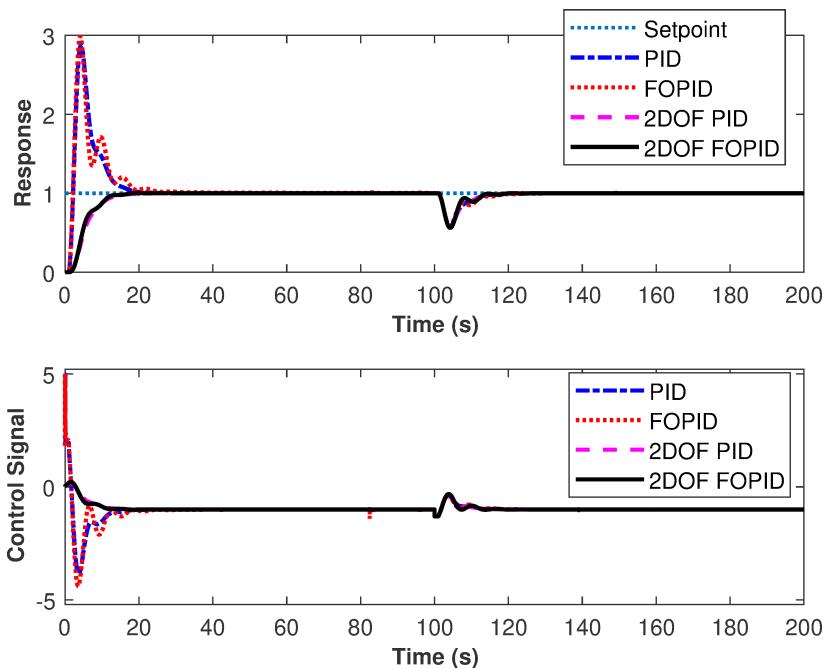

Figure 28: Set-point tracking and disturbance rejection performance comparison of various standard form of controllers

of all controllers was found to be satisfactory with the PID having the fastest recovery with  $t_{s2}$  of 112.75 s.

Table 17: Controller parameters and performance analysis of various standard form of controllers

Controller	$K_p$	$T_i$	$T_d$	$\alpha$	$b$	$c$	$\lambda$	$\mu$	$t_r$	$t_{s1}$	$t_{s2}$	%OS
PID	1.8294	13.7860	0.7181	0.0152	1.0	1.0	1.0	1.0	0.8316	17.7484	112.7530	187.7207
FOPID	1.8294	13.7860	0.7181	0.0152	1.0	1.0	0.97	0.92	0.7703	23.3838	115.8060	199.3169
2DOF PID	1.8294	13.7860	0.7181	0.0152	0.0186	0.0	1.0	1.0	7.8788	15.6226	114.8759	0.2633
2DOF FOPID	1.8294	13.7860	0.7181	0.0152	0.0186	0.0	0.97	0.92	7.8755	15.3824	113.3261	0.0005

To evaluate the performance of various controllers to variation in reference signal, the plant is made to track variable set-point with various controllers as shown in Figure 29. It is observed from the response that, during set-point change, the 1DOF based controller (i.e., PID and FOPID) produced higher overshoots while the 2DOF based controllers produced smaller overshoots. Observing the control signals of the controllers, it can be seen that the 1DOF based controllers have derivative kick effects while this effect is significantly reduced in the 2DOF based controllers.

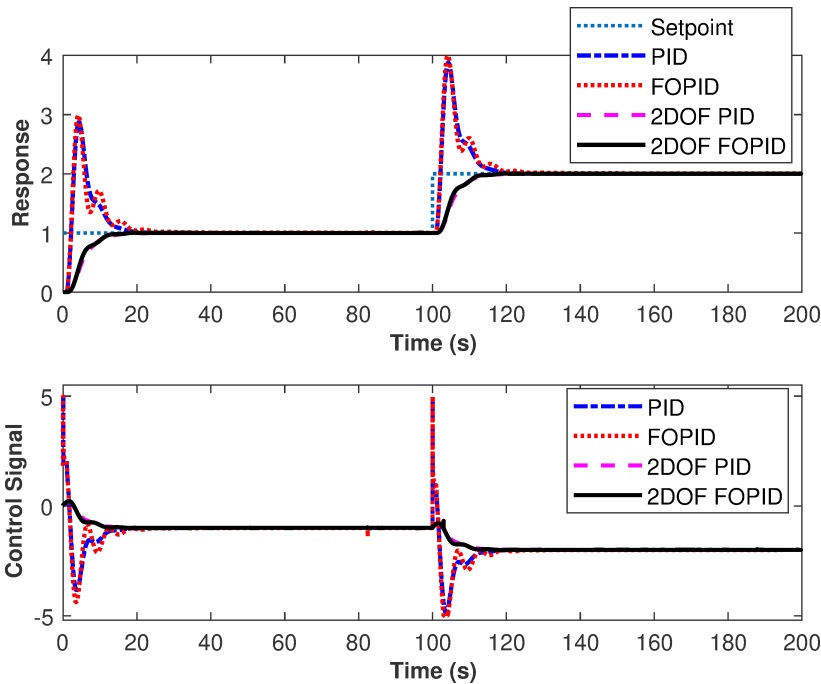

Figure 29: Variable set-point tracking performance comparison of various standard form of PIDs on USOPDT system

### 7.3. Unstable Third Order Plus Dead Time (UTOPDT) System

In a similar way to earlier systems in Section 7.1.5 and 7.2, the tuned parameters of the standard PIDs compared are given in Table 18.

Table 18: Controller parameters and performance analysis of various standard form of PIDs on UTOPDT system

Controller	$K_p$	$T_i$	$T_d$	$\alpha$	$b$	$c$	$\lambda$	$\mu$	$t_r$	$t_{s1}$	$t_{s2}$	%OS
PID	3.0326	14.6628	2.3592	0.0151	1.0	1.0	1.0	1.0	2.3607	28.0483	120.9497	60.8517
FOPID	3.0326	14.6628	2.3592	0.0151	1.0	1.0	0.98	0.95	2.0795	28.1442	120.5152	61.5605
2DOF PID	3.0326	14.6628	2.3592	0.0151	0.0175	0.0	1.0	1.0	12.3712	32.2013	120.9502	2.6492
2DOF FOPID	3.0326	14.6628	2.3592	0.0151	0.0175	0.0	0.98	0.95	14.2489	23.1937	123.2245	1.4885

The comparison of the responses of the third order system with various standard form of controllers for set-point tracking and disturbance rejection are given in Figure 30. Numerical analysis of the performance of the controllers is also given in Table 18. From the figure and the table, it is clearly seen that the 2DOF based controllers produced responses with very little overshoots compared to the 1DOF PID controller. However, the response times of the 1DOF controllers is

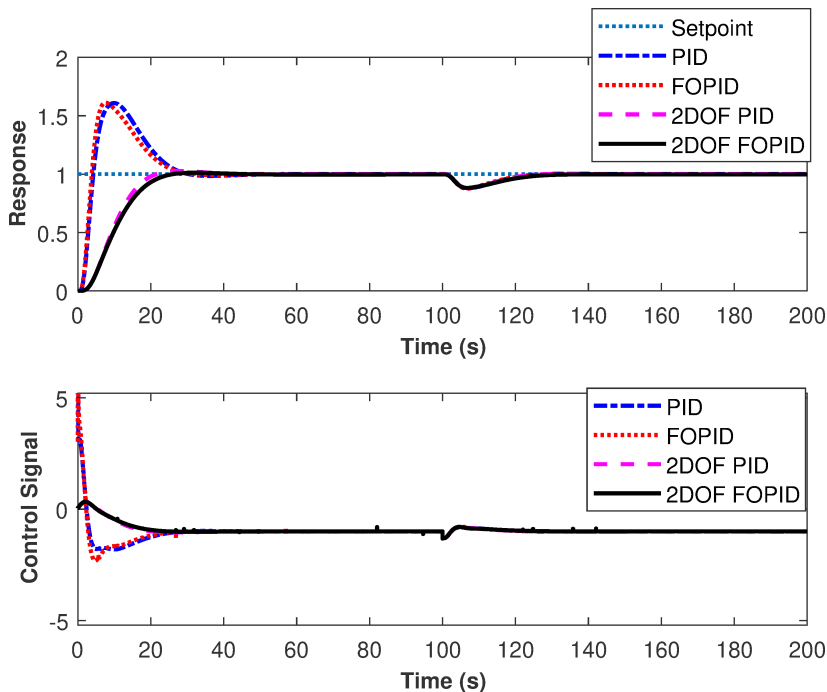

Figure 30: Set-point tracking and disturbance rejection performance comparison of various standard form of controllers

faster than the 2DOF controllers. This is at the expense of overshoot. It is also observed that all controllers recovered from the effect of disturbance at around 120 s. Furthermore, as shown in Figure 31, similar trend of variable set-point tracking is observed on this system as in the case of first and second order systems.

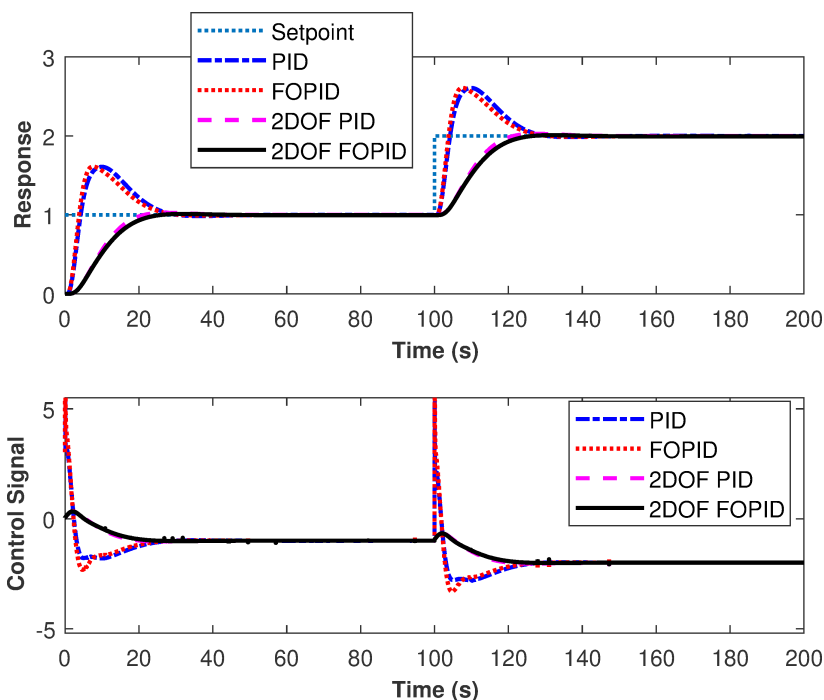

Figure 31: Variable set-point tracking performance comparison of various standard form of controllers

## 8. Conclusion

This paper has reviewed various PID controllers and their conversion from one form to another. From these forms, the control actions of 2DOF PID, FOPID and 2DOF FOPID controllers were derived. Furthermore, equivalent configurations of the standard 2DOF FOPID controller such as feedforward, feedback, pre-filter and component separated type have been presented.

As a proof of concept, comparative study on a class of unstable systems with all the controllers discussed has been undertaken. In the study, consideration has been given to set-point tracking, disturbance rejection and suppression of derivative kick effect. Simulation results show that the conversion from one form to another has little effect on the performance of the controllers. Results further

showed that the 2DOF controllers (2DOF PID and 2DOF FOPID) suppressed the effect of derivative kick more than the other variants of the PID. This effect is more noticeable with 2DOF FOPID variant. Another noticeable advantage of the 2DOF controllers is that they produced less overshoot and faster settling time. Hence, better set-point tracking performance.

### References

- [1] K.J. ÅSTRÖM and T. HÄGGLUND: The future of PID control, *Control engineering practice*, **9**(11) (2001), 1163–1175.
- [2] P. SHAH and S. AGASHE: Review of fractional PID controller, *Mechatronics*, **38** (2016), 29–41.
- [3] V.M. ALFARO and R. VILANOVA: Conversion formulae and performance capabilities of two-degree-of-freedom PID control algorithms, in *Emerging Technologies & Factory Automation (ETFA), 2012 IEEE 17th Conference on*. IEEE, 2012, pp. 1–6.
- [4] M. ARAKI and H. TAGUCHI: Two-degree-of-freedom PID controllers, *International Journal of Control Automation and Systems*, **1** (2003), 401–411.
- [5] K.H. ANG, G. CHONG, and Y. LI: PID control system analysis, design, and technology, *IEEE transactions on control systems technology*, **13**(4) (2005), 559–576.
- [6] V.M. ALFARO and R. VILANOVA: *Model-Reference Robust Tuning of PID Controllers*, Springer, 2016.
- [7] K. BINGI, R. IBRAHIM, M.N. KARSITI, and S.M. HASSAN: Fractional order set-point weighted PID controller for pH neutralization process using accelerated PSO algorithm, *Arabian Journal for Science and Engineering*, **43**(6) (2018), 2687–2701.
- [8] R. SHARMA, P. GAUR, and A. MITTAL: Performance analysis of two-degree of freedom fractional order PID controllers for robotic manipulator with payload, *ISA transactions*, **58** (2015), 279–291.
- [9] P. DWIVEDI, S. PANDEY, and A. JUNGHARE: Performance Analysis and Experimental Validation of 2-DOF Fractional-Order Controller for Underactuated Rotary Inverted Pendulum, *Arabian Journal for Science and Engineering*, **12** (2017), 1–25.



- [10] S. PANDEY, P. DWIVEDI, and A. JUNGHARE: A novel 2-DOF fractional-order  $PI\lambda-D\mu$  controller with inherent anti-windup capability for a magnetic levitation system, *AEU-International Journal of Electronics and Communications*, **79** (2017), 158–171.
- [11] R. AZARMI, M. TAVAKOLI-KAKHKI, A.K. SEDIGH, and A. FATEHI: Analytical design of fractional order PID controllers based on the fractional set-point weighted structure: Case study in twin rotor helicopter, *Mechatronics*, **31** (2015), 222–233.
- [12] S. DEBBARMA, L.C. SAIKIA, and N. SINHA: Automatic generation control of multi-area system using two degree of freedom fractional order PID controller: a preliminary study, in *Power and Energy Engineering Conference (APPEEC), 2013 IEEE PES Asia-Pacific*. IEEE, 2013, pp. 1–6.
- [13] S. DEBBARMA, L.C. SAIKIA, N. SINHA, B. KAR, and A. DATTA: Fractional order two degree of freedom control for AGC of an interconnected multi-source power system, in *Industrial Technology (ICIT), 2016 IEEE International Conference on*. IEEE, 2016, pp. 505–510.
- [14] S. DEBBARMA, L.C. SAIKIA, and N. SINHA: Automatic generation control using two degree of freedom fractional order PID controller, *International Journal of Electrical Power & Energy Systems*, **58** (2014), 120–129.
- [15] F. PADULA and A. VISIOLI: Set-point weight tuning rules for fractional-order PID controllers, *Asian Journal of Control*, **15**(3) (2013), 678–690.
- [16] H. RASOULI and A. FATEHI: Design of set-point weighting  $PI\lambda+D\mu$  controller for vertical magnetic flux controller in Damavand tokamak, *Review of Scientific Instruments*, **85**(12) (2014), p. 123508.
- [17] M. LI, P. ZHOU, Z. ZHAO, and J. ZHANG: Two-degree-of-freedom fractional order-PID controllers design for fractional order processes with dead-time, *ISA transactions*, **61** (2016), 147–154.
- [18] Z. LI, L. LIU, S. DEHGHAN, Y. CHEN, and D. XUE: A review and evaluation of numerical tools for fractional calculus and fractional order controls, *International Journal of Control*, **90**(6) (2017), 1165–1181, DOI: 10.1080/00207179.2015.1124290.
- [19] C.A. MONJE, Y. CHEN, B.M. VINAGRE, D. XUE, and V. FELIU-BATLLE: *Fractional-order Systems and Controls: Fundamentals and Applications*. Springer Science & Business Media, 2010.
- [20] E.C. DE OLIVEIRA and J.A. TENREIRO MACHADO: A Review of Definitions for Fractional Derivatives and Integral, *Math. Probl. Eng.*, 2014.

- [21] I. PETRÁŠ: Tuning and implementation methods for fractional-order controllers, *Fractional Calculus and Applied Analysis*, **15**(2) (2012), 282–303.
- [22] R. KHALIL, M. AL HORANI, A. YOUSEF, and M. SABABHEH: A new definition of fractional derivative, *Journal of Computational and Applied Mathematics*, **264** (2014), 65–70.
- [23] D. CAFAGNA: Fractional calculus: A mathematical tool from the past for present engineers [Past and present], *IEEE Industrial Electronics Magazine*, **1**(2) (2007), 35–40.
- [24] J. WANG, G. YANG, B. ZHANG, Z. SUN, Y. LIU, and J. WANG: Convergence analysis of Caputo-type fractional order complex-valued neural networks, *IEEE Access*, **5** (2017), 14560–14571, DOI: 10.1109/ACCESS.2017.2679185.
- [25] B. VINAGRE, I. PODLUBNY, A. HERNANDEZ, and V. FELIU: Some approximations of fractional order operators used in control theory and applications, *Fractional calculus and applied analysis*, **3**(3) (2000), 231–248.
- [26] D. VALÉRIO, J.J. TRUJILLO, M. RIVERO, J.T. MACHADO, and D. BALEANU: Fractional calculus: A survey of useful formulas, *The European Physical Journal Special Topics*, **222**(8) (2013), 1827–1846.
- [27] A. OUSTALOUP, P. MELCHIOR, P. LANUSSE, O. COIS, and F. DANCLA: The CRONE toolbox for MATLAB, in *Computer-Aided Control System Design, 2000. CACSD 2000. IEEE International Symposium on*, IEEE, 2000, pp. 190–195.
- [28] I. PETRAS: *Fractional-Order Nonlinear Systems: Modeling, Analysis and Simulation*, Springer Science & Business Media, 2011.
- [29] D. XUE, Y. CHEN, and D.P. ATHERTON: *Linear feedback control: analysis and design with MATLAB*, SIAM, 2007.
- [30] K.J. ÅSTRÖM and T. HÄGGLUND: *PID Controllers: Theory, Design, and Tuning*. ISA Research Triangle Park, NC, 1995.
- [31] A. VISIOLI: *Practical PID Control*, Springer Science & Business Media, 2006.
- [32] R. VILANOVA and A. VISIOLI: *PID Control in the Third Millennium: Lessons Learned and New Approaches*, Springer, 2012.

- [33] S. SKOGESTAD: Simple analytic rules for model reduction and PID controller tuning, *Journal of process control*, **13**(4) (2003), 291–309.
- [34] K.J. ÅSTRÖM and T. HÄGGLUND: *Advanced PID Control*. ISA-The Instrumentation, Systems and Automation Society, 2006.
- [35] N. KANAGARAJ, P. SIVASHANMUGAM, and S. PARAMASIVAM: Fuzzy coordinated PI controller: application to the real-time pressure control process, *Advances in Fuzzy Systems*, **8** (2008), p. 2.
- [36] S.W. SUNG, J. LEE, and I.-B. LEE: *Process identification and PID control*, John Wiley & Sons, 2009.
- [37] X. GAO, C. SHANG, D. HUANG, and F. YANG: A novel approach to monitoring and maintenance of industrial PID controllers, *Control Engineering Practice*, **64** (2017), 111–126.
- [38] I. BOIKO: Variable-structure PID controller for level process, *Control Engineering Practice*, **21**(5) (2013), 700–707.
- [39] C.-C. YU: *Autotuning of PID controllers: A relay feedback approach*, Springer Science & Business Media, 2006.
- [40] T. LIU and F. GAO: *Industrial process identification and control design: step-test and relay-experiment-based methods*. Springer Science & Business Media, 2011.
- [41] I. RUSNAK: *Family of the PID Controllers, Introduction to PID Controllers – Theory, Tuning and Application to Frontier Areas*, InTech, 2012.
- [42] T. HÄGGLUND: Signal filtering in PID control, *IFAC Proceedings Volumes*, **45**(3) (2012), 1–10.
- [43] V.R. SEGOVIA, T. HÄGGLUND, and K.J. ÅSTRÖM: Measurement noise filtering for PID controllers, *Journal of Process Control*, **24**(4) (2014), 299–313.
- [44] T. HÄGGLUND: A unified discussion on signal filtering in PID control, *Control engineering practice*, **21**(8) (2013), 994–1006.
- [45] K.K. TAN, Q.-G. WANG, and C.C. HANG: *Advances in PID control*. Springer Science & Business Media, 2012.
- [46] H.S. SÁNCHEZ and R. VILANOVA: Optimality comparison of 2DoF PID implementations, in *System Theory, Control and Computing (ICSTCC), 2014 18th International Conference*, IEEE, 2014, pp. 591–596.

- [47] V.M. ALFARO, R. VILANOVA, and O. ARRIETA: Considerations on set-point weight choice for 2-DoF PID controllers, *IFAC Proceedings Volumes*, **42**(11) (2009), 721–726.
- [48] A. VISIOLI: Adaptive tuning of fuzzy set-point weighting for PID controllers, *IFAC Proceedings Volumes*, **33**(4) (2000), 455–460.
- [49] R.K. SAHU, S. PANDA, and U.K. ROUT: DE optimized parallel 2-DOF PID controller for load frequency control of power system with governor dead-band nonlinearity, *International Journal of Electrical Power & Energy Systems*, **49** (2013), 19–33.
- [50] R. MANTZ: A PI controller with dynamic set-point weighting for nonlinear processes, *IFAC Proceedings Volumes*, **45**(3) (2012), 512–517.
- [51] L. MUSMADE and M. CHIDAMBARAM: Learning Automata based Set-point weighted parameter for unstable systems, *IFAC Proceedings Volumes*, **47**(1) (2014), 122–126.
- [52] A. GHOSH, T.R. KRISHNAN, P. TEJASWY, A. MANDAL, J.K. PRADHAN, and S. RANASINGH: Design and implementation of a 2-DOF PID compensation for magnetic levitation systems, *ISA transactions*, **53**(4) (2014), 1216–1222.
- [53] Q. JIN and Q. LIU: Analytical IMC-PID design in terms of performance/robustness tradeoff for integrating processes: From 2-Dof to 1-Dof, *Journal of Process Control*, **24**(3), (2014), 22–32.
- [54] V. RAJINIKANTH and K. LATHA: Setpoint weighted PID controller tuning for unstable system using heuristic algorithm, *Archives of Control Sciences*, **22**(4) (2012), 481–505.
- [55] A. DEGHANI and A. LANZON: Discussion on: “2-DOF Controller Design for Precise Positioning a Spindle Levitated with Active Magnetic Bearings”, *European Journal of Control*, **18**(2) (2012), 207–209.
- [56] A. RODRIGUEZ-MARTINEZ and R. GARDUNO-RAMIREZ: 2 DOF fuzzy gain-Scheduling PI for combustion turbogenerator speed control, *IFAC Proceedings Volumes*, **45**(3) (2012), 276–281.
- [57] N. PACHAURI, V. SINGH, and A. RANI: Two degree of freedom PID based inferential control of continuous bioreactor for ethanol production, *ISA transactions*, **68** (2017), 235–250.

- [58] R.K. MUDI and C. DEY: Performance improvement of PI controllers through dynamic set-point weighting, *ISA transactions*, **50**(2) (2011), 220–230.
- [59] F.D. BIANCHI, R.J. MANTZ, and C.F. CHRISTIANSEN: Multivariable PID control with set-point weighting via BMI optimisation, *Automatica*, **44**(2) (2008), 472–478.
- [60] R.K. SAHU, S. PANDA, U.K. ROUT, and D.K. SAHOO: Teaching learning based optimization algorithm for automatic generation control of power system using 2-DOF PID controller, *International Journal of Electrical Power & Energy Systems*, **77** (2016), 287–301.
- [61] V. ALFARO, R. VILANOVA, and O. ARRIETA: Robust tuning of two-degree-of-freedom (2-DoF) PI/PID based cascade control systems, *Journal of process control*, **19**(10) (2009), 1658–1670.
- [62] M. VITECKOVA and A. VITECEK: 2DOF PI and PID controllers tuning, *IFAC Proceedings Volumes*, **43**(2) (2010), 343–348.
- [63] G.J. SILVA, A. DATTA, and S.P. BHATTACHARYYA: *PID Controllers for Time-Delay Systems*, Springer Science & Business Media, 2007.
- [64] J.E. NORMEY-RICO: *Control of dead-time processes*, Springer Science & Business Media, 2007.
- [65] A. VISIOLI and Q. ZHONG: *Control of integral processes with dead time*, Springer Science & Business Media, 2010.
- [66] K.J. ÅSTRÖM and R.M. MURRAY: *Feedback systems: an introduction for scientists and engineers*, Princeton University press, 2010.
- [67] K.G. PAPADOPOULOS: *PID Controller Tuning Using the Magnitude Optimum Criterion*, Springer, 2015.
- [68] S.K. SWAIN, D. SAIN, S.K. MISHRA, and S. GHOSH: Real Time Implementation of Fractional Order PID Controllers for a Magnetic Levitation Plant, *AEU-International Journal of Electronics and Communications*, 2017.
- [69] I. PETRÁS: Fractional derivatives, fractional integrals, and fractional differential equations in MATLAB, in *Engineering Education and Research Using MATLAB*, InTech, 2011.
- [70] D. VALÉRIO and J. SÁ DA COSTA: *An introduction to fractional control*, Institution of Engineering and Technology, 2013.

- [71] C.I. MURESAN, E.H. DULF, and R. BOTH: Vector-based tuning and experimental validation of fractional-order PI/PD controllers, *Nonlinear Dynamics*, **84**(1) (2016), 179–188.
- [72] R. DE KEYSER, C.I. MURESAN, and C.M. IONESCU: A novel auto-tuning method for fractional order PI/PD controllers, *ISA transactions*, **62** (2016), 268–275.
- [73] P. ROY, B. KAR, and B.K. ROY: Fractional Order PI-PD Control of Liquid Level in Coupled Two Tank System and its Experimental Validation, *Asian Journal of Control*, **19**(5) (2017), 1–11, DOI: 10.1002/asjc.1487.
- [74] Y. LUO and Y. CHEN: Fractional order [proportional derivative] controller for a class of fractional order systems, *Automatica*, **45**(10) (2009), 2446–2450.
- [75] M. TAVAKOLI-KAKHKI and M. HAERI: Fractional order model reduction approach based on retention of the dominant dynamics: Application in IMC based tuning of FOPI and FOPID controllers, *ISA transactions*, **50**(3) (2011), 432–442.
- [76] T. VINOPRABA, N. SIVAKUMARAN, S. NARAYANAN, and T. RADHAKRISHNAN: Design of internal model control based fractional order PID controller, *Journal of Control Theory and Applications*, **10**(3) (2012), 297–302.
- [77] C.A. MONJE, B.M. VINAGRE, V. FELIU, and Y. CHEN: Tuning and auto-tuning of fractional order controllers for industry applications, *Control engineering practice*, **16**(7) (2008), 798–812.
- [78] F. PADULA and A. VISIOLI: Tuning rules for optimal PID and fractional-order PID controllers, *Journal of process control*, **21**(1) (2011), 69–81.
- [79] Y. SU, D. SUN, and B. DUAN: Design of an enhanced nonlinear PID controller, *Mechatronics*, **15**(8) (2005), 1005–1024.
- [80] H.-B. DUAN, D.-B. WANG, and X.-F. YU: Novel approach to nonlinear PID parameter optimization using ant colony optimization algorithm, *Journal of Bionic Engineering*, **3**(2) (2006), 73–78.
- [81] P. MELCHIOR, B. ORSONI, O. LAVIALLE, and A. OUSTALOUP: The CRONE toolbox for Matlab: fractional path planning design in robotics, in *Robot and Human Interactive Communication, 2001. Proceedings. 10th IEEE International Workshop on*, IEEE, 2001, pp. 534–540.

- [82] R. MALTI and S. VICTOR: Crone toolbox for system identification using fractional differentiation models, *IFAC-PapersOnLine*, **48**(28) (2015), 769–774.
- [83] D. VALERIO and J.S. DA COSTA: Ninteger: a non-integer control toolbox for MATLAB, *Proceedings of the Fractional Differentiation and its Applications, Bordeaux*, 2004.
- [84] N. LACHHAB, F. SVARICEK, F. WOBBE, and H. RABBA: Fractional order PID controller (FOPID)-toolbox, in *Control Conference (ECC), 2013 European*, IEEE, 2013, pp. 3694–3699.
- [85] E. PISONI, A. VISIOLI, and S. DORMIDO: An interactive tool for fractional order PID controllers, in *Industrial Electronics, 2009. IECON'09. 35th Annual Conference of IEEE*, IEEE, 2009, pp. 1468–1473.
- [86] A. TEPLJAKOV, E. PETLENKOV, and J. BELIKOV: FOMCON: a MATLAB toolbox for fractional-order system identification and control, *International Journal of Microelectronics and Computer Science*, **2**(2) (2011), 51–62.
- [87] A. TEPLJAKOV: Fractional-order calculus based identification and control of linear dynamic systems, *Tallinn University of Technology*, 2011.
- [88] A. TEPLJAKOV, E. PETLENKOV, and J. BELIKOV: Fomcon: Fractional-order modeling and control toolbox for matlab, in *Mixed Design of Integrated Circuits and Systems (MIXDES), 2011 Proceedings of the 18th International Conference*, IEEE, 2011, pp. 684–689.
- [89] R. CAPONETTO: *Fractional Order Systems: Modeling and Control Applications*, World Scientific, 2010, vol. 72.
- [90] J. SABATIER, O.P. AGRAWAL, and J.T. MACHADO: *Advances in fractional calculus*, Springer, 2007, vol. 4, no. 9.
- [91] D. BALEANU, J.A.T. MACHADO, and A.C. LUO: *Fractional Dynamics and Control*, Springer Science & Business Media, 2011.
- [92] I. PAN and S. DAS: *Intelligent Fractional Order Systems and Control: An Introduction*, Springer, 2012, vol. 438.
- [93] D. XUE: *Fractional-Order Control Systems: Fundamentals and Numerical Implementations*, Walter de Gruyter GmbH & Co KG, 2017, vol. 1.
- [94] A.J. MICHAEL and H.M. MOHAMMAD: *PID Control: New Identification and Design Methods*, 2005.



- [95] H. TAGUCHI and M. ARAKI: Two-degree-of-freedom PID controllers—their functions and optimal tuning, *IFAC Proceedings Volumes*, **33**(4) (2000), 91–96.
- [96] J. SÁNCHEZ, A. VISIOLI, and S. DORMIDO: A two-degree-of-freedom PI controller based on events, *Journal of Process Control*, **21**(4) (2011), 639–651.
- [97] R. GOREZ: New design relations for 2-DOF PID-like control systems, *Automatica*, **39**(5) (2003), 901–908.
- [98] F. PADULA and A. VISIOLI: Set-point filter design for a two-degree-of-freedom fractional control system, *IEEE/CAA Journal of Automatica Sinica*, **3**(4) (2016), 451–462.
- [99] P. PADHY and S. MAJHI: Relay based PI–PD design for stable and unstable FOPDT processes, *Computers & Chemical Engineering*, **30**(5) (2006), 790–796.
- [100] A. VISIOLI: Optimal tuning of PID controllers for integral and unstable processes, *IEE Proceedings-Control Theory and Applications*, **148**(2) (2001), 180–184.
- [101] G. PRASHANTI and M. CHIDAMBARAM: Set-point weighted pid controllers for unstable systems, *Journal of the Franklin Institute*, **337**(2) (2000), 201–215.
- [102] C.-C. CHEN, H.-P. HUANG, and H.-J. LIAW: Set-point weighted PID controller tuning for time-delayed unstable processes, *Industrial & Engineering Chemistry Research*, **47**(18) (2008), 6983–6990.
- [103] R.P. SREE and M. CHIDAMBARAM: Simple method of calculating set point weighting parameter for unstable systems with a zero, *Computers & Chemical Engineering*, **28**(11) (2004), 2433–2437.