

*KORNEL WARWAS \* , IWONA ADAMIEC-WÓJCIK \*\**

## MODELLING ARTICULATED VEHICLES WITH A FLEXIBLE SEMI-TRAILER

The paper presents a model of an articulated vehicle with a flexible frame of a semi-trailer. The rigid finite element method in a modified formulation is used for discretisation of the frame. In order to carry out effective numerical simulation, a reduced model with a considerably smaller number of degrees of freedom is proposed. The parameters of the reduced model are chosen in an optimization process by using a genetic algorithm. To this end, it is assumed that the full and reduced model have to be similar in the range of static deflections and frequencies of free vibrations. Numerical simulations are concerned with the influence of the flexibility of the frame on the motion of the articulated vehicle during an overtaking maneuver. Results are presented and discussed.

### 1. Introduction

Examination of the influence of the flexibility of elements, including the semi-trailer, on the motion of a vehicle is one of the important problems in dynamic analysis of articulated vehicles. Commercial packages, such as MSC.ADAMS, which enable complicated models of multibody systems to be formulated, can be used for modeling vehicles, as discussed in [1, 2, 3]. Authors' own models of vehicles are still developed in many research centers despite wide access to the commercial packages. Those models are often devoted to specific applications and analysis, for example friction models, choice of braking and drive moments or models of special vehicles [4, 5, 6, 7]. This paper presents a development of spatial models of articulated vehicles described in [8, 9]. A model of an articulated vehicle with consid-

---

\* *University of Bielsko-Biala, ul. Willowa 2, 43-309 Bielsko-Biala, Poland; E-mail: kwarwas@ath.eu*

\*\* *University of Bielsko-Biala, ul. Willowa 2, 43-309 Bielsko-Biala, Poland; E-mail: i.adamiec@ath.eu*

eration of flexibility of a semi-trailer is formulated, based on homogenous transformations and joint coordinates [8, 10]. The frame of the semi-trailer is discretised by means of the modified rigid finite element method [11, 12]. In order to obtain a numerically effective computer model, a procedure enables us to reduce the number of elements into which the frame is divided, and thus the number of generalized coordinates. To this end the algorithm presented uses genetic algorithms. Below the main elements of the model and results of simulation for a double change of lane maneuver are presented.

## 2. Equation of motion of the articulated vehicle

The equations of motion for the articulated vehicle are formulated using the Lagrange equations [13]. Nonlinear differential equations can be written in the following matrix form:

$$\mathbf{A}\ddot{\mathbf{q}} = \mathbf{f} \quad (1)$$

where:  $\mathbf{f} = \mathbf{Q} - \mathbf{h} - \mathbf{G} - \mathbf{K}\mathbf{q} - \bar{\mathbf{D}}\dot{\mathbf{q}}$  – vector of the right side of the equations of motion,

$\mathbf{A}$ ,  $\mathbf{h}$ ,  $\mathbf{G}$ ,  $\mathbf{K}$ ,  $\bar{\mathbf{D}}$ ,  $\mathbf{Q}$  – defined in [14].

Often the equations of motion have to be modified when during motion some degrees of freedom are fixed. Such a situation occurs when modeling phases of stick-slip friction between elements [6] or defining reaction forces between subsystems, for example between a fifth-wheel and semi-trailer. This approach is also used when we introduce into the system determined values, for example when the turning angle of vehicle wheels is known [14]. The constraint equations can be written in the acceleration form:

$$\mathbf{D}^T \ddot{\mathbf{q}} = \mathbf{W} \quad (2)$$

where:  $\mathbf{D} = (d_{ij})_{i=1, \dots, N, j=1, \dots, n_c}$  – matrix of coefficients of constraint reactions,

$\mathbf{W}$  – vector of the right side of the constraint equations,

$N$  – number of generalized coordinates of the system,

$n_c$  – number of constraint equations.

By completing equations (1) with constraint equations (2) the following is obtained:

$$\begin{cases} \mathbf{A}\ddot{\mathbf{q}} - \mathbf{D}\mathbf{R} = \mathbf{f} \\ \mathbf{D}^T \ddot{\mathbf{q}} = \mathbf{W} \end{cases} \quad (3)$$

where:  $\mathbf{R} = [R_1 \ \dots \ R_{n_c}]^T$  – vector of unknown reactions.

In the paper the rigid finite element method [11, 15] is used in order to model flexible links. A flexible body is divided into rigid finite elements (rfes) connected by mass-less and nondimensional spring-damping elements

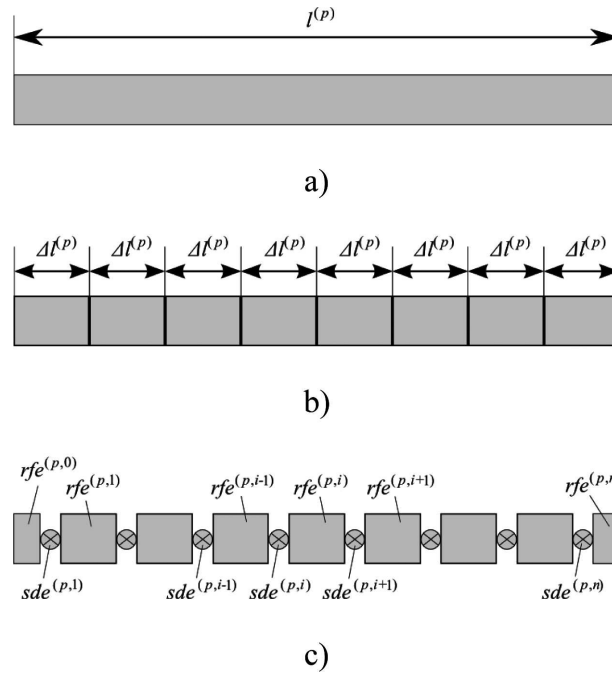

Fig. 1. Discretisation of a flexible link a) before discretisation, b) primary division, c) secondary division

in a two-stage discretisation process. Rfes reflect mass features of the body while sdes reflect its spring and damping features (Fig. 1).

It should be noted that in the rigid finite element method a rigid body can be treated as a specific case of a flexible body while a flexible body can be treated as an open chain of rigid bodies connected with spring elements. An advantage of such an approach is the possibility of obtaining equations in a similar form (3).

### 3. Model of an articulated vehicle

Fig. 2 presents a model of the articulated vehicle under consideration. It consists of a tractor, a fifth wheel and a semi-trailer. The semi-trailer can be treated either as a rigid or flexible body.

It is assumed that the tractor is a rigid body, the motion of which is described by means of six generalized coordinates with respect to the inertial frame of reference:

$$\tilde{\mathbf{q}}^{(1)} = [ x^{(1)} \quad y^{(1)} \quad z^{(1)} \quad \psi^{(1)} \quad \theta^{(1)} \quad \phi^{(1)} ]^T \quad (4)$$

where:  $x^{(1)}, y^{(1)}, z^{(1)}$  – coordinates of the center of mass of the tractor,  $\psi^{(1)}, \theta^{(1)}, \phi^{(1)}$  – ZYX Euler angles.



a)

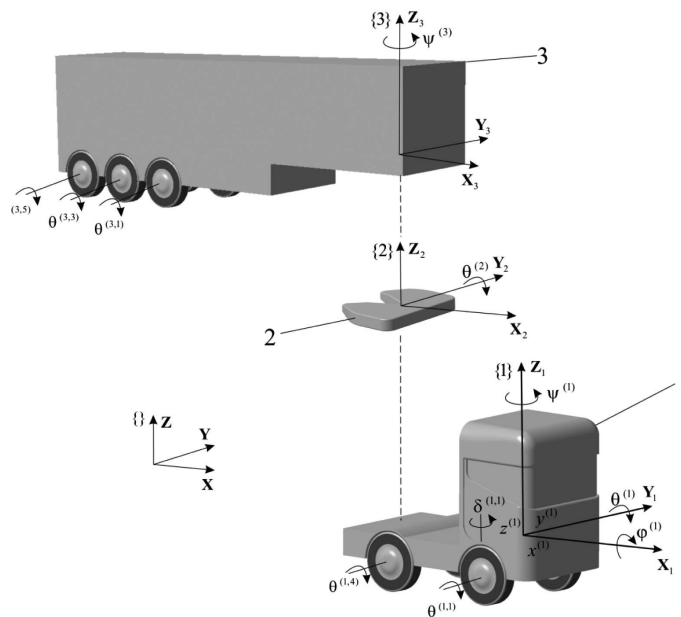

b)

Fig. 2. Model of the articulated vehicle a) vehicle, b) multibody system: 1 - tractor, 2 – fifth wheel, 3 – semi-trailer

The fifth wheel is also treated as a rigid body. Its motion with respect to the tractor is defined by a vector with one component:

$$\tilde{\mathbf{q}}^{(2)} = [\theta^{(2)}] \quad (5)$$

when:  $\theta^{(2)}$  – pitch angle.

The semi-trailer, when it is treated as a rigid body, has one degree of freedom with respect to the fifth wheel:

$$\tilde{\mathbf{q}}^{(3)} = [\psi^{(3)}] \tag{6a}$$

where:  $\psi^{(3)}$  – yaw angle of the semi-trailer.

When the semi-trailer is treated as a flexible body, this motion is described by the generalized coordinate of rfe 0:

$$\tilde{\mathbf{q}}^{(3,0)} = [\psi^{(3,0)}] \tag{6b}$$

where:  $\psi^{(3,0)} = \psi^{(3)}$ .

The relative motion of rfes 1- $n^{(3)}$  connected with their predecessor by spring-damping elements is described by components of the following vectors:

$$\tilde{\mathbf{q}}^{(3,i)} = [\psi^{(3,i)} \quad \theta^{(3,i)} \quad \varphi^{(3,i)}]^T \tag{7}$$

The tractor and the trailer are connected with a road by suspensions and wheels. Fig. 3 presents models of the independent and dependent suspensions considered.

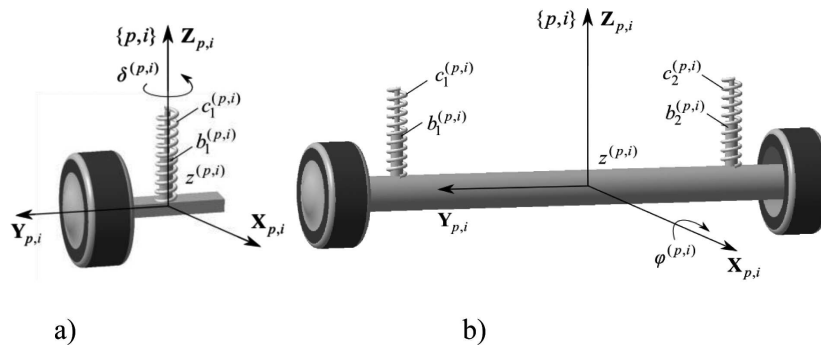

Fig. 3. Suspension models a) independent suspension, b) dependent suspension

The motion of the dependent suspension in relation to the body of the tractor or respective rfe of the semi-trailer is defined by the components of the vector:

$$\tilde{\mathbf{q}}^{(p,i)} = \begin{cases} [z^{(p,i)} \quad \delta^{(p,i)}]^T & \text{if the suspension is connected with} \\ & \text{the driven wheel} \\ z^{(p,i)} & \text{otherwise} \end{cases} \tag{8}$$

where:  $z^{(p,i)}$  – vertical displacement,  
 $\delta^{(p,i)}$  – known wheel angle,

$p$  – preceding body (1 – tractor, 3 – rfe of the semi trailer),  
 $i$  – number of the suspension.

The motion of the dependent suspensions is defined by the following vectors:

$$\tilde{\mathbf{q}}^{(p,i)} = \begin{bmatrix} z^{(p,i)} & \varphi^{(p,i)} \end{bmatrix}^T \quad (9)$$

where:  $z^{(p,i)}$  – vertical displacement,  
 $\varphi^{(p,i)}$  – roll angle,  
 $p, i$  – defined in (8).

The relative motion of the wheels with respect to the suspension is described by one degree of freedom:

$$\tilde{\mathbf{q}}^{(p,i)} = \begin{bmatrix} \theta^{(p,i)} \end{bmatrix} \quad (10)$$

where:  $\theta^{(p,i)}$  – rotation angle of the wheel,  
 $p$  – preceding body,  
 $i$  – number of the wheel.

Reaction forces of the road on the wheels are defined according to the Dugoff-Uffelman model described in [6, 16].

#### 4. Discretisation of the frame of the semi trailer

For box and flatbed semi-trailers the frame is the dominant element if we assume the mass as a criterion influencing the motion of the articulated vehicle. The model of the frame assumed for further considerations is presented in Fig. 4. Discretisation of links with a changing cross-section is carried out as described in [14].

The model presented above, called a full model, can be used for solving a static task in the initial problem and for analyzing linear vibrations; however, because of its complexity (more than 500 generalized coordinates for  $n^{(3)} = 170$ ) and long calculation time it is not useful for simulations of dynamics of the articulated vehicle.

Thus the algorithm for reduction of generalized coordinates and formulation of a reduced simplified model (Fig. 5) has been elaborated. The reduced model consists of a considerably smaller number of rigid finite elements connected by means of spring-damping elements with stiffness coefficients chosen in such a way that they reflect real features of the frame modeled.

It is assumed that the frame for the reduced model is divided into rigid finite elements formed by connecting elements with shapes shown in Fig. 6.

Masses, inertial moments and positions of the centers of mass of elements are calculated according to the number of rfes in the reduced model. Having calculated the mass parameters, we have to define stiffness coefficients for

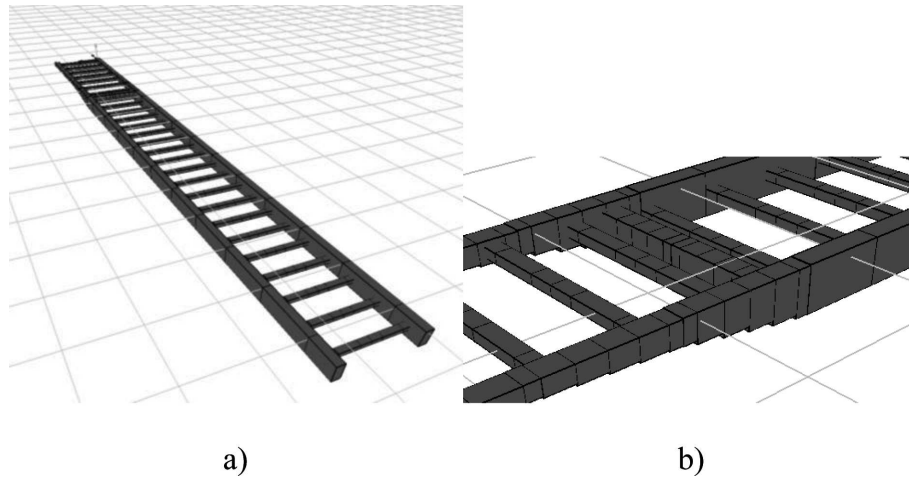

Fig. 4. Model of the frame of the semi-trailer a) discretisation into rfes b) discretisation for a changing cross-section

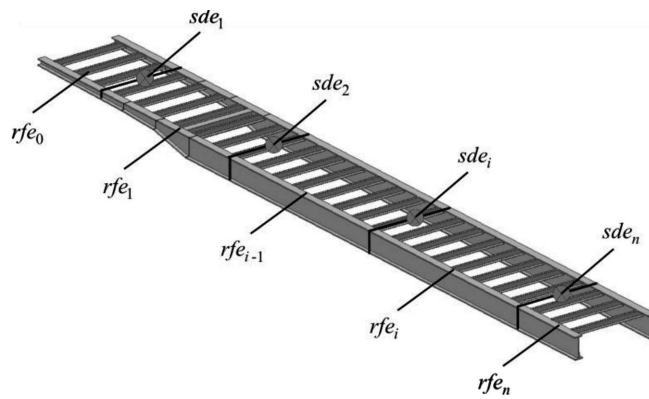

Fig. 5. Reduced model of the frame

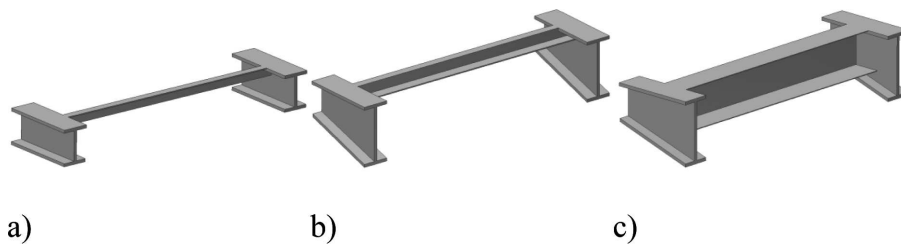

Fig. 6. Components of the frame for the reduced model, two double-tee bars a) connected by Z-bar, b) with changing cross-section connected by Z-bar, c) with changing cross-section connected by channel bar

sdes. To this end it is assumed that the reduced model is equivalent to the full model if the following parameters:

- mass,
  - maximal static deflections caused by an external force,
  - defined number of frequencies of free vibration,
- are the same or very close to each other.

The process of preparation of the reduced model, which will be then used for dynamic analysis, is presented in Fig. 7.

The first condition (mass) is not directly connected with the choice of stiffness coefficients of the spring, but it indicates correctness of the reduced model. Fulfillment of the two other conditions is not easy for a choice of the spring coefficients.

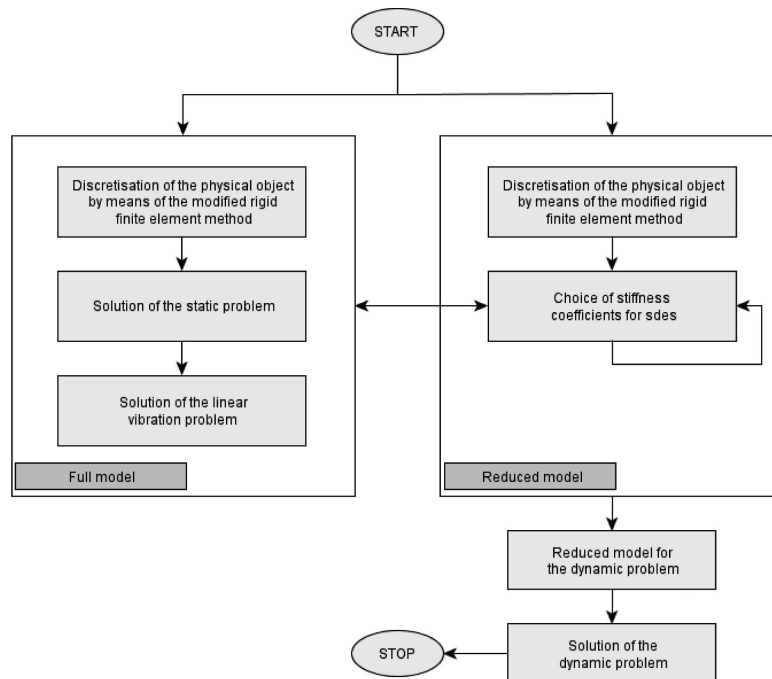

Fig. 7. Algorithm for preparation of the reduced model

To solve this problem, an optimization task has been formulated. Stiffness coefficients of sdes are decisive variables for this problem:

$$\mathbf{x} = \left[ \mathbf{c}^{(1)T} \quad \dots \quad \mathbf{c}^{(i)T} \quad \dots \quad \mathbf{c}^{(n_{est})T} \right]^T \quad (11)$$

where:  $\mathbf{c}^{(1)} = \left( c_j^{(i)} \right)_{j=1, \dots, \tilde{N}^{(i)}}$ ,  
 $c_j^{(i)} \in \{c_4^{(i)}, c_5^{(i)}, c_6^{(i)}\}$  – defined in [14],



$n_{est}$  – number of sdes in the reduced model,  
 $\tilde{N}_{est}^{(i)} \in \{1, 2, 3\}$  according to the number and type of the vibrations considered.

In the task of choice of parameters of sdes for the substitute model the following functional is minimized:

$$\Omega = w \left( 1 - \frac{f_z^{(z)}}{f_z^{(p)}} \right)^2 + \sum_{i=1}^{N_{est}} g_i \left( 1 - \frac{e_i^{(z)}}{e_i^{(p)}} \right)^2 \rightarrow \min \quad (12)$$

where:  $w, g_i$  – weights empirically chosen,

$f_z^{(p)}$  – maximal static deflection of the frame in the full model

$f_z^{(z)}$  – maximal static deflection of the frame in the reduced model,

$e_i^{(p)}$  – frequencies of free vibrations in the full model,

$e_i^{(z)}$  – frequencies of free vibrations in the reduced model,

$N_{est}$  – number of free vibrations compared.

Coefficients  $c_j^{(i)}$  are limited:

$$c_{\max} \leq c_j^{(i)} \leq c_{\min} \quad (13)$$

Optimization is carried out using genetic algorithms [18] with real-number representation of genes in chromosomes. The following genetic operators are used [19, 20]:

- natural selection – operator which is used for selection of chromosomes for reproduction according to the rule that the larger values of the fitness function is the most likely selection for the next population,
- crossover – operator which randomly chooses two chromosomes and changes their sequence of genes. In the paper the arithmetical one-point crossover is used in which a new chromosome is a linear combination of two vectors. Children  $\tilde{\mathbf{x}}_i$  and  $\tilde{\mathbf{x}}_j$  from parent chromosomes  $\mathbf{x}_i$  and  $\mathbf{x}_j$  are defined in the following way:

$$\begin{aligned} \tilde{\mathbf{x}}_i &= a\mathbf{x}_i + (1 - a)\mathbf{x}_j \\ \tilde{\mathbf{x}}_j &= (1 - a)\mathbf{x}_i + a\mathbf{x}_j \end{aligned} \quad (14)$$

where:  $a \in [0, 1]$  – random number,

- mutation – operator which randomly changes genes in the chromosome. In this paper we use a non-uniform mutation. If in epoch  $t$  gene  $c_i$  of chromosome  $\mathbf{x}^t = [c_1 \dots c_i \dots c_l]^T$  is chosen for mutation the result is:

$$\mathbf{x}^{t+1} = [c_1 \dots \tilde{c}_i \dots c_l]^T \quad (15)$$

$$\text{where: } \tilde{c}_i = \begin{cases} c_i + \Delta(t, c_{\max} - c_i) & \text{for } a = 0 \\ c_i - \Delta(t, c_{\max} - c_i) & \text{for } a = 1 \end{cases},$$

$a \in \{0, 1\}$  – random number,

$\Delta(t, c) = c(1 - r^{(1-t/T)^b}) \in [0, c]$ ,

$r \in [0, c]$  – random number,

$T$  – maximal number of epochs,

$b$  – constant,

$l$  – number of genes in the chromosome.

The algorithm for the choice of the stiffness coefficients in the reduced model is presented in Fig. 8.

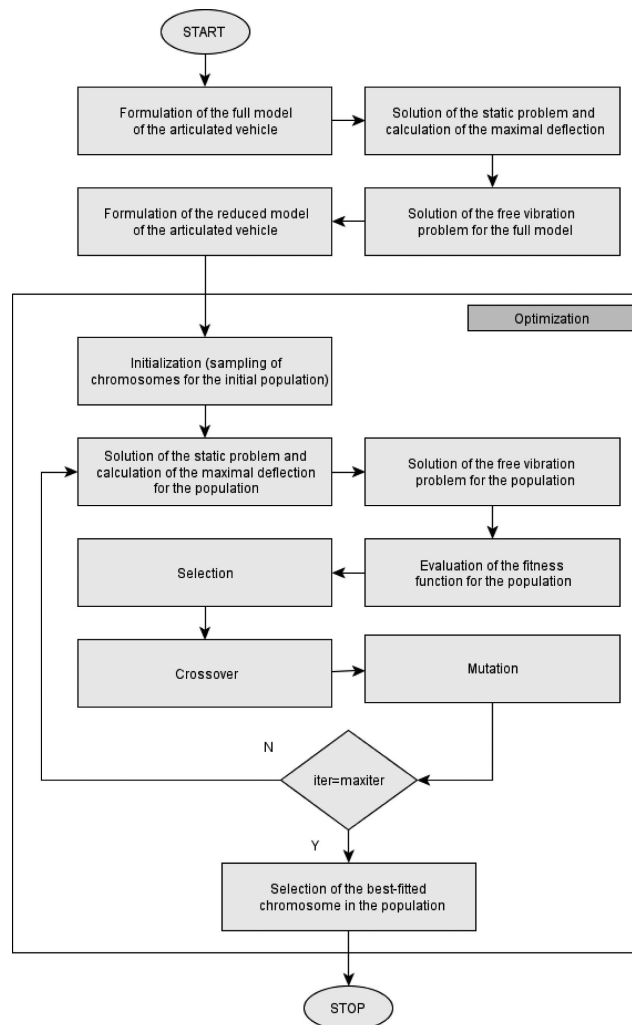

Fig. 8. Algorithm for choosing stiffness coefficients of sdes in the reduced model

The static problem is solved and frequencies of free vibrations are calculated in order to determine the fitness function for each chromosome. The fitness function is defined as follows:

$$F = \frac{w_g}{\Omega} \rightarrow \max \tag{16}$$

where:  $w_g$  – weight,  
 $\Omega$  – defined in (9).

Maximal and minimal values of stiffness coefficients are assumed to be:

- a)  $c_{\min} = 10^4$  N/rad,
- b)  $c_{\max} = 10^8$  N/rad.

Calculations have been carried out by assuming in the reduced model a different number of rfs (from 2 to 10) into which the frame was divided. The results obtained for the same tasks for the full model have been used as reference values. Exemplary values of fitness function for chosen chromosomes are presented in Fig. 9

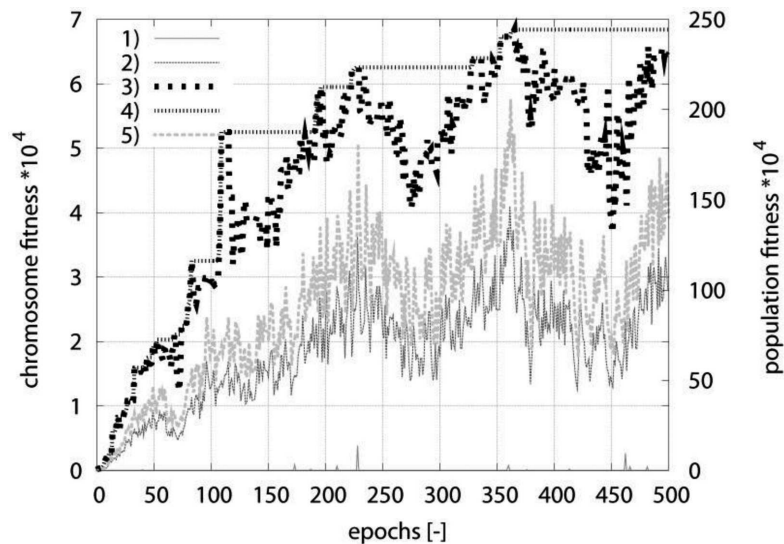

Fig. 9. Fitness function for chromosomes in successive epochs 1) the worst chromosome in the population, 2) average for all chromosomes in the population, 3) the best chromosome in the population, 4) the best chromosome in successive generations, 5) sum of fitness function for all chromosomes in the population

Tables 1 and 2 present results obtained and relative errors for the best chromosome in the population (for 6 rfs) in relation to the results obtained for the full model.

Table 1.

Maximal static deflections of the frame

Full model [m]	Reduced model [m]	Relative error [%]
0.02665	0.02575	3.382

Table 2.

Frequencies of free vibrations of the frame

Mode	Full model [Hz]	Reduced model [Hz]	Relative error [%]
1	0.660	0.632	4.242
2	1.574	1.523	3.219
3	2.327	2.466	5.976
4	7.021	6.802	3.114
5	9.061	8.951	1.210
6	10.171	10.340	1.663
7	12.737	12.657	0.626
8	20.872	19.933	4.495
9	24.187	24.072	0.476
10	25.047	25.429	1.525

Static deflections obtained from the authors' own program for the full model are shown in Fig. 10 while Fig. 11 shows the first ten modes of free vibrations.

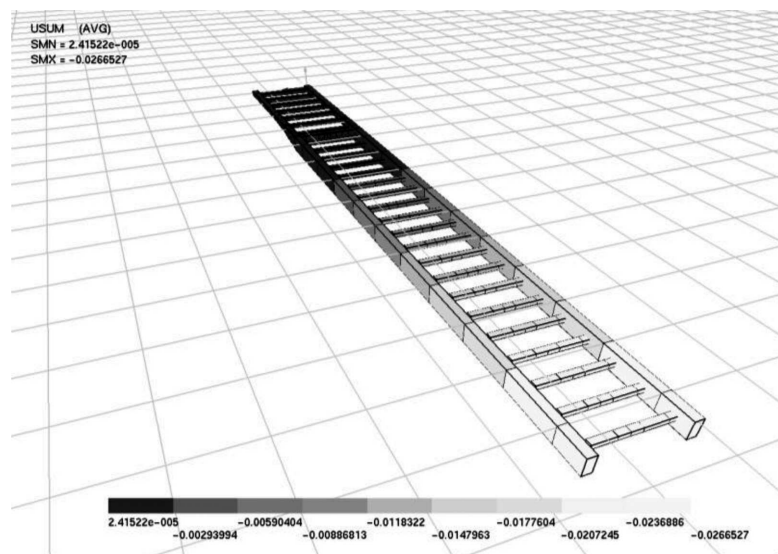
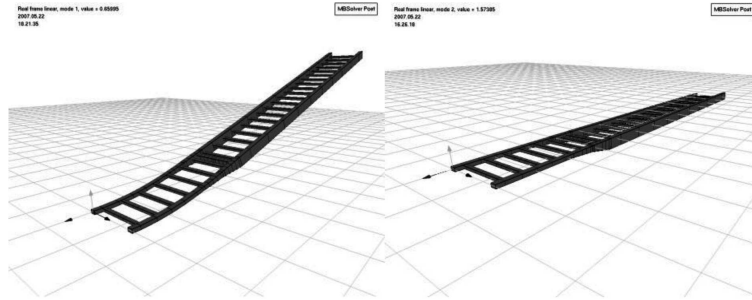
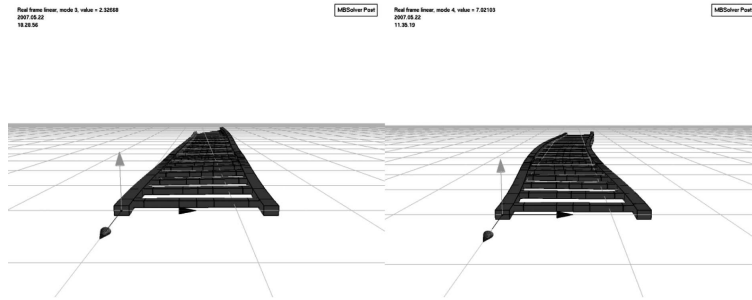

Fig. 10. Static deflections of the frame of the semi-trailer



Mode 1

Mode 2



Mode 3

Mode 4

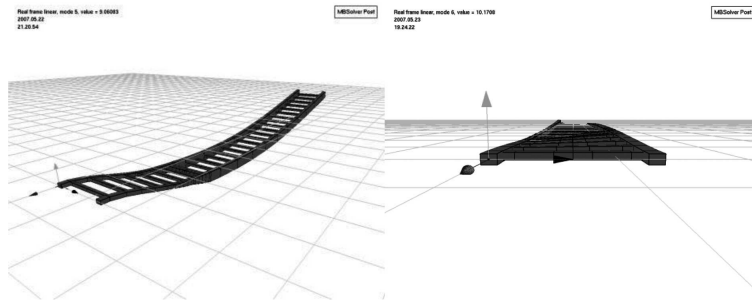

Mode 5

Mode 6

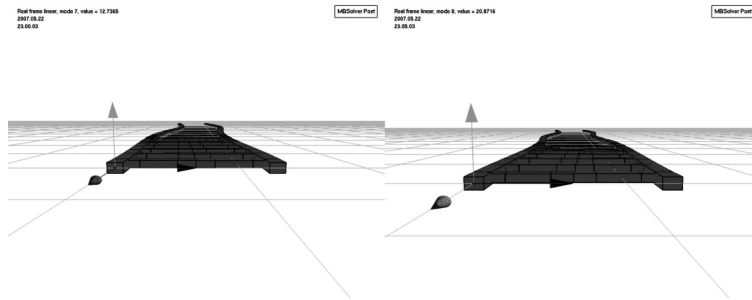

Mode 7

Mode 8

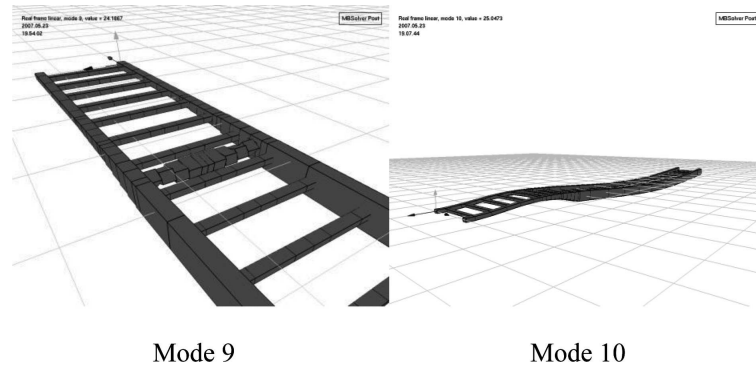

Mode 9 Mode 10

Fig. 11. Modes of free vibrations of the frame

Relatively small errors (below 6%) in comparison to the results obtained for the full model allow us to conclude that the reduced model can be used for further analysis of the motion of the articulated vehicle.

## 5. Numerical simulations

An overtaking maneuver is chosen for numerical simulations testing the influence of the semi-trailer flexibility on the motion of the vehicle. Fig. 12 presents the course of the turning angle of the front wheels of the tractor with the parameters as in [14] and the initial velocity  $v_0 = 60$  km/h. Numerical simulations have been carried out for two variants. In the first one, the articulated vehicle has not been loaded with any additional mass and the results are shown in Figs 13 and 14.

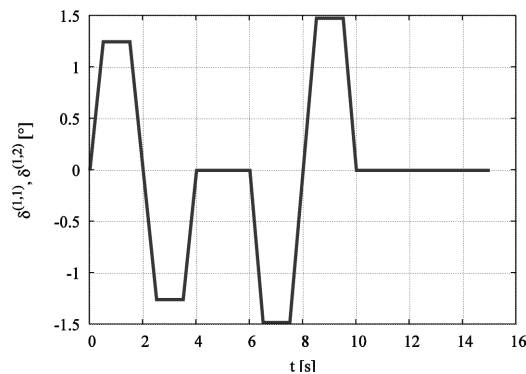

Fig. 12. Turning angle of the front wheels of the tractor

By analyzing graphs in Fig.13 it can be seen that the maximal difference in courses for transverse displacement of the vehicle with rigid and flexible frame divided into 10 rigid finite elements is 0.05 m, which is about 1% in

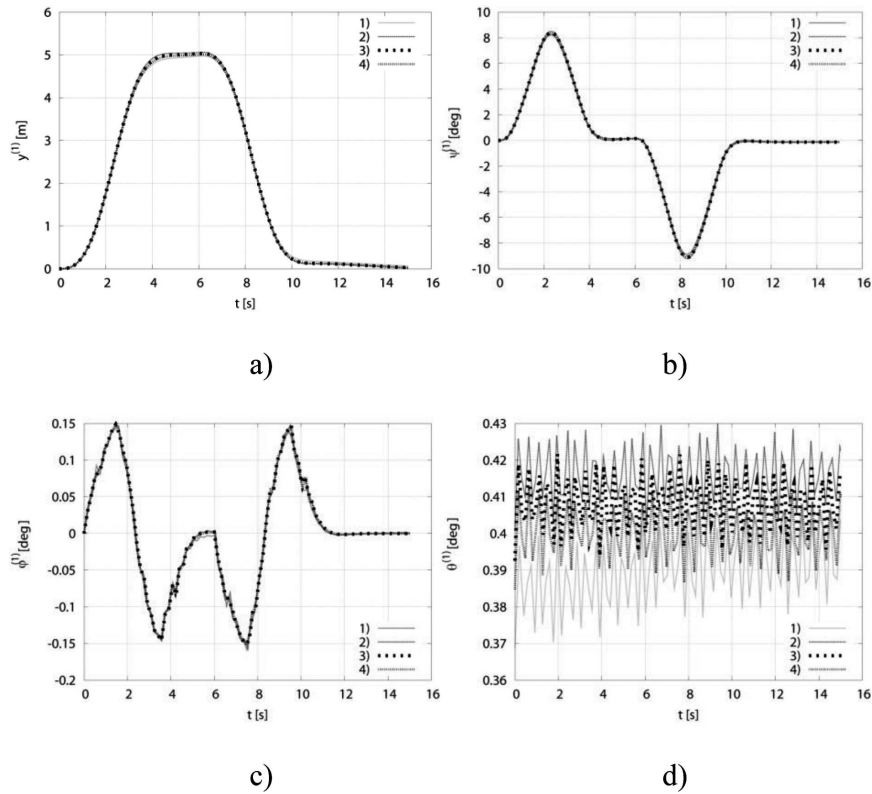

Fig. 13. Results of simulations with a semi-trailer 1) denotes the rigid frame, 2), 3) and 4) denote the flexible frame divided into 4, 6 and 10 elements respectively, a) transverse displacement of the tractor, b) yaw angle of the tractor, c) roll angle of the tractor, d) pitch angle of the tractor

comparison to the rigid model. The differences for a larger number of rfs cannot be observed and thus for further analysis it is assumed that the frame is divided into 6 rfs.

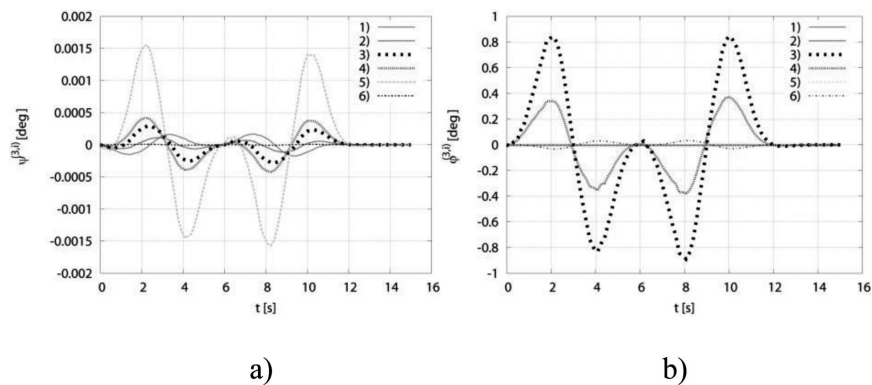

Fig. 14. Courses of a) yaw angle b) roll angle of rfs 1 to 6 of the frame

In the second variant it has been assumed that an additional load evenly spread increases the mass of the frame by 9000 kg. Calculation results are shown in Figs 15 and 16.

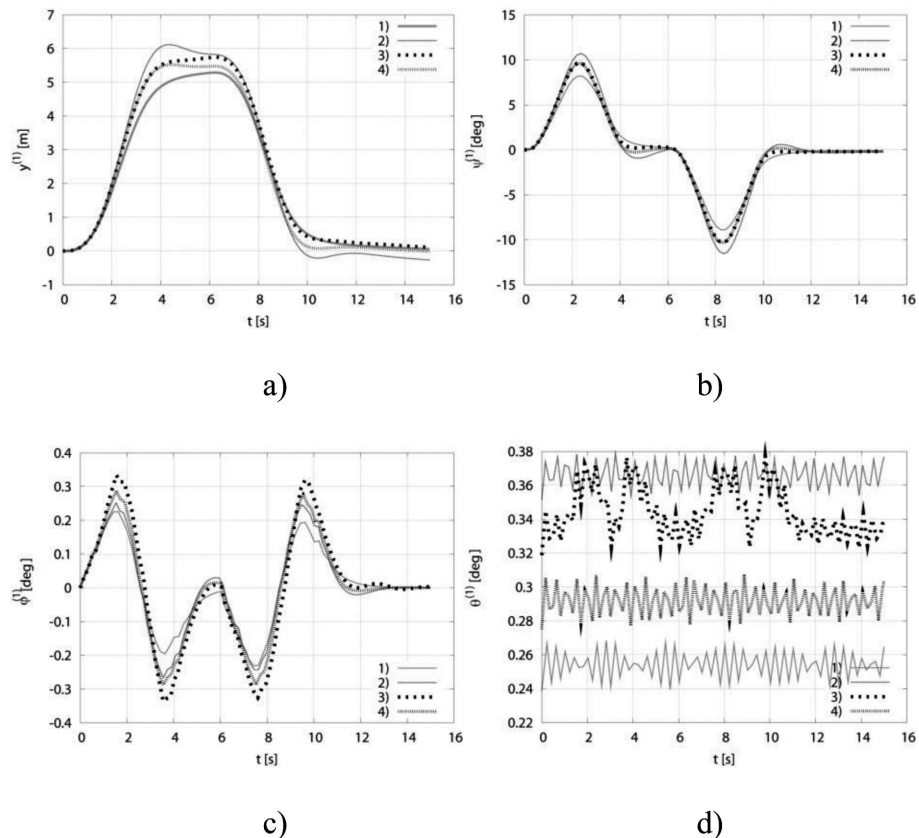

Fig. 15. Results of simulations with a semi-trailer with the additional mass of 9000 kg; 1) denotes the rigid frame, 2), 3) and 4) denote the flexible frame divided into 4, 6 and 10 elements respectively, a) transverse displacement of the tractor, b) yaw angle of the tractor, c) roll angle of the tractor, d) pitch angle of the tractor

By analyzing graphs 13 and 15 one can notice that the flexibility of the empty semi-trailer is insignificant for the motion of the whole vehicle, while the flexibility of the frame can considerably influence the motion of the articulated vehicles when the semi-trailer is additionally loaded.

The same conclusion one can draw by inspecting Fig.14 and 16, where large differences in the extreme values of the roll angle of the semi-trailer can be also noted for a vehicle without the additional load in comparison to that with additional mass of 9000 kg.

The analysis presented above and in [14] results in the conclusion that the influence of the flexibility on the motion of a vehicle increases in a



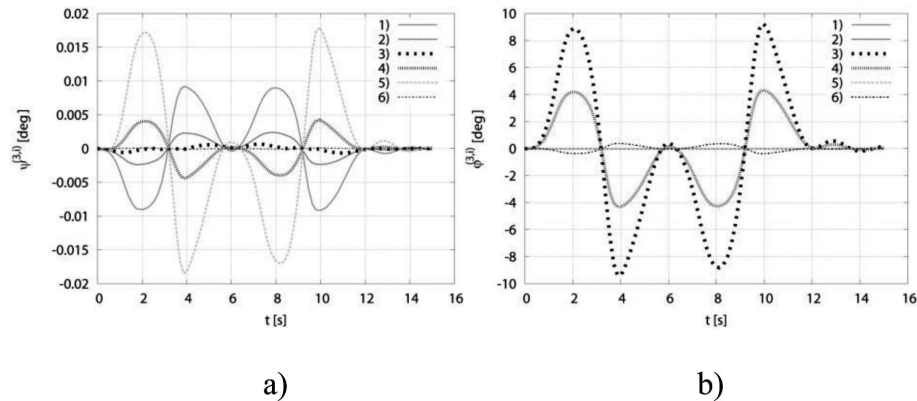

Fig. 16. Courses of a) yaw angle b) roll angle of rfs 1 to 6 of the frame

quasi-linear fashion with the increase of the mass of the semi-trailer. Linear increase can be also observed for courses of rotation angles of all rfs of the semi-trailer frame.

## 6. Final remarks

In order to carry out numerical simulations of an articulated vehicle with a flexible frame, the model prepared has to be numerically effective and reflect reality as closely as possible. The paper presents a process of formulation of such a model by creating a full model and replacing it by a simplified model. Having chosen appropriate parameters of the reduced model, numerical simulations enabling us to solve the dynamics of the vehicle with a flexible frame can be carried out. It should be noted that both models, full and reduced, have been obtained by means of the rigid finite element method. The results for the overtaking maneuver indicate that the influence of the flexibility of the frame with no additional loads is insignificant and may be omitted. However, in most cases articulated vehicles carry a load and thus consideration of the flexibility of the frame can be essential in computer simulations of dynamics of the articulated vehicles.

Manuscript received by Editorial Board, November 27, 2012;  
final version, March 12, 2013.

## REFERENCES

- [1] Adamski D., Schuster C., Hiller M.: The Toolset FASIM.C++ for the Simulation of Vehicle Dynamics, *Journal of the Brazilian Society of Mechanical Sciences*. 1999. vol.21, No. 4, pp. 683-698.

- [2] Anderson D., Schade G.: Tractor/Semi Trailer Ride Quality Prediction Using a Template Based Approach, Proc. North American MDI User Conference 2001, <http://www.mscsoftware.com/support/library/conf/adams/na/2001/papers.cfm>
- [3] Frączek J.: Modeling and dynamical analysis of flexible vehicle using FEM and MS approach, Proc. 16th European ADAMS User Conference 2001, [http://www.mscsoftware.com/support/library/conf/adams/euro/2001/proceedings/papers\\_pdf/Paper\\_19.pdf](http://www.mscsoftware.com/support/library/conf/adams/euro/2001/proceedings/papers_pdf/Paper_19.pdf)
- [4] Cole D.J., Cebon D.: Predicting Vertical Dynamic Tire Forces of Heavy Trucks, in Kulakowski B.T.(ed.): Vehicle-Road Interaction, ASTM STP 1225, Philadelphia, pp. 27-35, 1994.
- [5] Kim S.-S., Won M.: Development of a real-time multibody vehicle and control model for a low cost virtual reality vehicle simulator: an application to adaptive cruise control, in Schiehlen W., Valásek M., (eds.) Virtual Nonlinear Multibody Systems 2003, NATO Science Series, II. Mathematics, Physics and Chemistry, vol. 103, pp. 419-426.
- [6] Grzeżożek W., Adamiec-Wójcik I., Wojciech S.: Computer modelling of dynamics of vehicles, (in Polish: Komputerowe Modelowanie Dynamiki Pojazdów Samochodowych), Cracow University of Technology Publishing House, Kraków, 2003.
- [7] Yi T.Y.: Vehicle Dynamic Simulations Based on Flexible and Rigid Multibody Models, SAE Paper No. 2000-01-0114, Society of Automotive Engineers, Detroit, 2000.
- [8] Adamiec-Wójcik I.: Modelling dynamics of multibody systems using homogenous transformations, University of Bielsko-Biała Publishing House, Bielsko-Biała, 2003.
- [9] Lozia Z.A.: Analysis of biaxial car motion based upon dynamic models, (in Polish Analiza ruchu samochodu dwuosowego na tle modelowania jego dynamiki) Warsaw University of Technology Publishing House, Warszawa, 1998.
- [10] Gronowicz A.: Fundamentals of analysis of kinematical systems (in Polish Podstawy analizy układów kinematycznych), Wrocław University of Technology Publishing House, Wrocław, 2003.
- [11] Kruszewski J., (ed): Rigid finite element method (in Polish: Metoda sztywnych elementów skończonych), Arkady, Warszawa, 1975.
- [12] Wittbrodt E., Adamiec-Wójcik I., Wojciech S.: Dynamics of flexible multibody systems: rigid finite element method, Springer Verlag, Berlin, 2006.
- [13] Leyko J.: Mechanics (in Polish: Mechanika ogólna), PWN, Warszawa, 2006.
- [14] Warwas K.: Analysis and control of motion of articulated vehicles with consideration of flexible elements (in Polish: Analiza i sterowanie ruchem pojazdów wielocłonowych z uwzględnieniem podatności elementów), PhD Thesis, University of Bielsko-Biała, 2007.
- [15] Wojciech S.: Dynamic analysis of manipulators with flexible links, Archive of Mechanical Engineering 1990, Vol. XXXVII. No.3, pp. 169-188.
- [16] Grzeżożek W.: Modelling dynamics of a vehicle with stability control of braking forces, (in Polish: Modelowanie dynamiki samochodu przy stabilizującym sterowaniu siłami hamowania), Cracow University of Technology Publishing House, Kraków, 2003.
- [17] Kruszewski J., Sawiak S., Wittbrodt E.: Rigid finite element method in dynamics of construction (in Polish: Metoda sztywnych elementów skończonych w dynamice konstrukcji), WNT, Warszawa, 1999.
- [18] Goldberg D.E.: Genetic algorithms and their application, (in Polish: Algorytmy genetyczne i ich zastosowania), WNT, Warszawa, 1995.
- [19] Koza J.R.: Genetic Programming, On the Programming of Computers by Means of Natural Selection, The MIT Press, Cambridge, Massachusetts, 1998.
- [20] Rothlauf F.: Representations for Genetic and Evolutionary Algorithms, Springer-Verlag, Netherlands, 2006.

**Modelowanie pojazdów wielozłączonych z uwzględnieniem podatności naczepy****Streszczenie**

W artykule przedstawiono model samochodu wielozłączowego z uwzględnieniem podatnej ramy naczepy. Do dyskretyzacji ramy wykorzystano metodę sztywnych elementów skończonych. W celu przeprowadzenia efektywnych numerycznych symulacji dynamiki zaproponowano model uproszczony, którego ruch opisano przy pomocy znacznie mniejszej liczby stopni swobody. Parametry modelu uproszczonego dobrano w procesie optymalizacji z wykorzystaniem algorytmów genetycznych zakładając, że ugięcia statyczne oraz określona liczba pierwszych częstości drgań własnych muszą być takie same w modelach uproszczonym i pełnym. Przedstawiono wyniki obliczeń numerycznych dotyczące wpływu podatności ramy naczepy na ruch pojazdu podczas manewru wyprzedzania.