

# Comparison of Wavelet Decomposition Coefficients Transmission Systems Using Splines and Classical Types of Modulation

Artem I. Kutin

*National Aviation University, Kiev, Ukraine*

**Abstract**—Wavelets are becoming increasingly used as a tool for the analysis of non-stationary data. To transmit the coefficients resulting from the signal decomposition traditionally their combination into a single data packet is used, without including unequal energy contribution of each factor and impact of the decomposition level. This paper analyzes (at different transmission speeds) the signals properties produced by classical modulation methods and spline modulation for wavelet coefficients transmission proposed by the author. For all signal types the additive Gaussian noise is used as a noise disturbance.

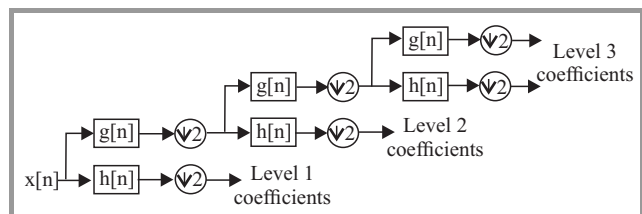
**Keywords**—*multi-speed channels, spline-modulation, spline Savitzky-Golay filter, wavelet decomposition.*

## 1. Introduction

Filter banks and wavelet decomposition, are widely used for the analysis of non-stationary one-dimensional and two-dimensional data in many areas of research, such as processing video, audio, seismic, cardiology and many other signals [1]–[4].

Continuous expansion of the multiscale data representation and their applications is an important factor that determines the development of transmission methods. Easy hardware and software implementation are the fundamental conditions for most data transmission systems. To one of feasible solution for the wavelet coefficients transmission this article is dedicated.

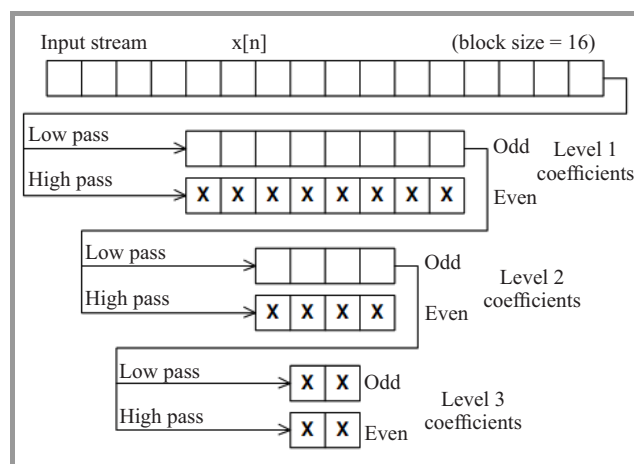
Classical structure of three level algorithm of wavelet decomposition proposed by Mallat is shown in Fig. 1 [5].



**Fig. 1.** Block-diagram of three-level wavelet decomposition.

At each decomposition level of approximating coefficients, detailing bits twice reduce their quantity at the expense

of decimation data, which is clearly seen in Fig. 2 [6]. On the last decomposition's level the number of approximating and detailing coefficients become equal. If the signal does not contain low frequency components, its approximation coefficients during the expansion are close to zero and don't have to be transmitted [4]. The simultaneous transfer of approximating and detailing coefficients is planned to be investigated later and in this article will not be considered.



**Fig. 2.** Sequential decimation in the discrete wavelet decomposition.

While considering the hierarchy of wavelet decomposition, then the highest level of decomposition is based on the coefficients that correspond to low frequency signal components.

In existing data transmission systems, the expansion coefficients obtained for direct transmission over the communication channel are encoded using Huffman or arithmetic compression algorithm and transmitted using the serial two- or multiposition modulation techniques, divided into packets using channel coding or not. The use of coding aligns the error's probability of all the coefficients, however, in many applied problems it is possible, from the perspective of reducing energy contribution, to assert with confidence that the coefficients significance proportionally decreases from the base of the pyramid to its top.

The situation is similar for data transmission systems of telemetry and remote control. The bits significance of binary words that correspond to the parameters of object's motion, i.e. speed, direction, for example, transmitted from the drone, is also not the same, decreases in proportion to the reduction in the weight category of the word. Errors in transmission LSBs will have less effect than MSBs.

Therefore, if the data transmission system due to its characteristics cannot guarantee the transmission's reliability of the coefficients at all decomposition's levels during changes of interference, e.g. without the use of channel coding. It must take into account their importance mentioned above.

The transmission through the communication channel of all coefficients can be done sequentially: first all the coefficients of one level of decomposition, then the next and so on and in parallel (simultaneous transmission of sequences of coefficients at all levels of decomposition).

Unlike parallel transmission, serial transmission the whole tree of coefficients requires an increase of the data rate in proportion to the number and capacity of coefficients, which is not always possible. Also, in this case is more difficult to provide a inverse relationship mechanism between the probability of occurrence of errors in the transmission coefficient and its significance in the wavelet decomposition.

In the process of wavelet decomposition of the generated coefficients for the same period of time, the ratio of the scale factor changes twice between adjacent levels. Respectively, it is possible to consider the data received on the output of the decomposition circuit (algorithm), as several multi-speed channels.

## 2. Analysis of Recent Research and the Problem Statement

It has to be noted that the transfer of the wavelet coefficients as variable-speed flow, until this time was not considered. Possible variant of implementation can be the integration of individual channels in the OFDM system (using classic types of modulation in each) or wavelet packet modulation [7]–[11]. But the applied mathematical apparatus requires complex hardware and DSP processor. To transfer data from sensors using inexpensive systems their application would not be justified.

Let us consider possible ways of transmission of the variable-speed data stream, that is existing, widely used modulation types: Multilevel Phase Shift Keying (MPSK), Multilevel Frequency Shift Keying (MFSK), M-ary Quadrature Amplitude Shift Keying (MQASK) and compare them with the spline modulation proposed by the author in [12] with certain modifications:

- interpolation directly exposed fragments of sine waves (previously fragments of sine waves were interpolated using cubic Hermite splines),

- the value of the signal amplitude across different channels (previously scope of each of the channels was the same),
- the number of channels is 8 (compared with 2 channels discussed earlier [12]).

Note, that the analysis is carried out at baseband, or rather its complex envelope, not a band-pass signal that can be considered like equivalent to [13], although it requires less time spent on modeling.

## 3. The Wavelet Coefficients Transfer's Characteristics of the Classical Types of Modulation and Spline-modulation

### 3.1. Transfer by the Spline Signal

Block diagram of a multi-speed digital data transmission system, implemented by using cubic Hermit splines (as Nyquist pulse) is shown in Fig. 3. It uses 8 channels in it is eight and equal to the number of levels of the wavelet expansion coefficients.

Binary sequence  $x_1-8$ , corresponding to the coefficients of detail wavelet decomposition from the generator coefficients of decomposition arrive at 8 interpolators, consisting of devices adding zeros (represented with arrows up) and filters with finite impulse response. The impulse response filter is a cubic spline samples.

Basic functions of local cubic Hermit spline  $B(t)$  is a smooth function with continuous first derivative and allows interpolated value of a specific function  $f(t)$  (in this case binary sequences in any one of the outputs of the expansion coefficients generator). The function  $f(t)$  takes in time one of the two possible values 0 or 1.

The general formulas of the spline equations and four fragments of which it is composed are of the form:

$$B(t) = f(t_1) \cdot X_0(t) + f(t_2) \cdot X_1(t) + f'(t_1) \cdot X_2(t) + f'(t_2) \cdot X_3(t),$$

$$X_0(t) = \frac{2 \cdot t^3 - 3 \cdot t^2 \cdot (t_1 + t_2) + 6 \cdot t_1 \cdot t_2 \cdot t - t_2^2 \cdot (3 \cdot t_1 - t_2)}{(t_1^2 - 2 \cdot t_1 \cdot t_2 + t_2^2) \cdot (t_2 - t_1)},$$

$$X_1(t) = \frac{(t - t_1)^2 \cdot (2 \cdot t + t_1 - 3 \cdot t_2)}{(t_1 - t_2) \cdot (t_1^2 - 2 \cdot t_1 \cdot t_2 + t_2^2)},$$

$$X_2(t) = \frac{(t - t_1) \cdot (t^2 - 2 \cdot t_2 \cdot t + t_2^2)}{(t_1 - t_2)^2},$$

$$X_3(t) = \frac{(t - t_1)^2 \cdot (t - t_2)}{(t_1 - t_2)^2},$$

where  $t$  – discrete times in the interval  $[t_1, t_2]$ ;  $t_1, t_2$  – time value of binary values occurrence at the output of the expansion coefficient generator (interpolation nodes);  $f(t_1), f(t_2)$  – binary values at the output of the decomposition generator (the function values of the nodal points);

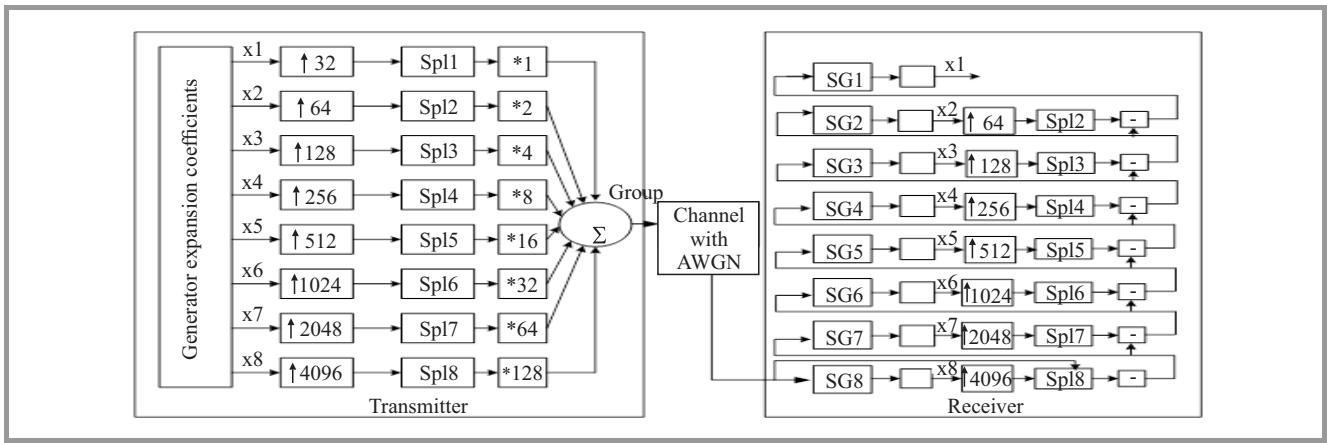


Fig. 3. Block diagram of an 8 multi-speed spline system of transmission of digital data.

$f'(t_1), f'(t_2)$  – derivatives of the function  $f(t)$  in time moment  $t_1$  and  $t_2$  (defined as the difference between the current value of the function and the value of in the previous time of binary values occurrence at the output of the expansion coefficients generator). Figure 4 shows the value of the function  $f(t)$  for the case when the signals at the output of the expansion coefficients generator at times  $t_1 = 0$  s and  $t_2 = 1$  s are equal respectively  $f(0) = 1$  and  $f(1) = 0$ . The derivatives in these times are equal respectively  $f'(0) = 0$  (assuming equal to zero the output state of the expansion coefficients generator until moment  $t_1$ ), and  $f'(1) = -1$ .

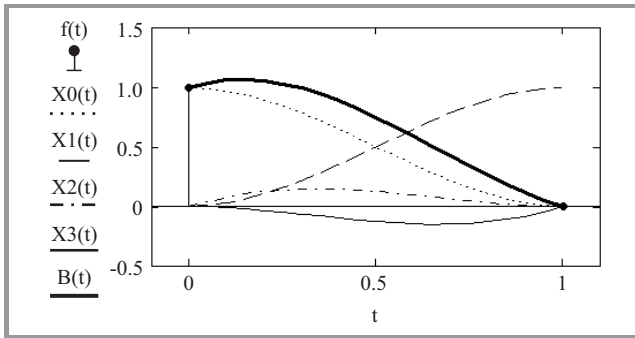


Fig. 4. The interpolation process of the binary sequence fragment using a spline.

The number of counts added to the interpolation process, is proportional to the interpolation factor as a multiple of two and is equal to  $2^5, 2^6, 2^7, 2^8, 2^9, 2^{10}, 2^{11}, 2^{12}$  for channels respectively from the first to the eighth.

Interpolators equalize the number of samples in the signal of each channel for the same period and generate a corresponding channel's spectrum. The resulting smoothed binary signals (Fig. 4) are multiplied by the appropriate scale factors, shown as numbers with multiplication sign ahead, and fed to an adder at whose output a group signal appears (group). It is equal to the algebraic sum of the channels signals. The described elements are transmitted (transmitter).

The rate of binary sequences arrival at each level of decomposition increases with decreasing channel number.

The spectrums of video signals corresponding to the coefficients of the expansion, are shown in Fig. 6 above. The spectra of these signals after the spline interpolation, for each of the channels are shown in Fig. 6 below.

Detailing of the baseband signal into the transmission channels from the first to the eighth 1024, 512, 256, 128, 64, 32, 16 and 8 bits respectively, and its energy spectrum is shown in Fig. 7a from above, and below is shown the corresponding energy spectrum.

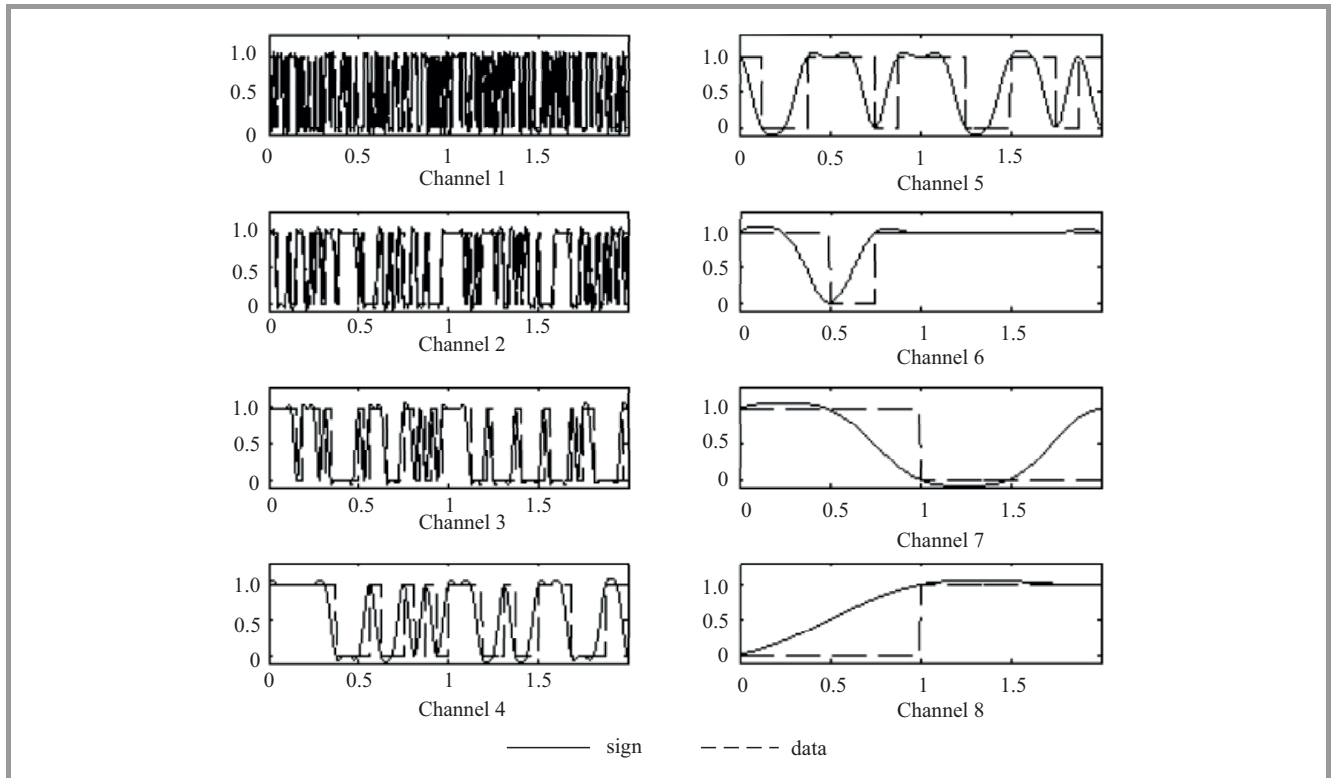
Figure 7a shows that the energy of the baseband signal due to the uneven capacity of each separate channels (due to scaling factors), focuses in the band the least speed channel. However, during transmission, the bandwidth should be limited to the first zero of the energy spectrum lobe highest speed channel, to store information in all channels. Group signal, after passing through the channel (channel with AWGN) in which it is added to the Gaussian noise arrives to the receiver (receiver). At the receiver group signal is in the process of decomposition to the individual channel signals, starting with the least-speed channel (Channel 8). Next, the signal passes through the spline filter Savitzky-Golay eighth channel (SG8) (filter Savitzky-Golay with the basis spline). This filter generates an estimate of the transmitted signal form of the eighth channel given by:

$$\widehat{S8} = (P8^T \cdot P8)^{-1} \cdot P8^T \cdot G\_N,$$

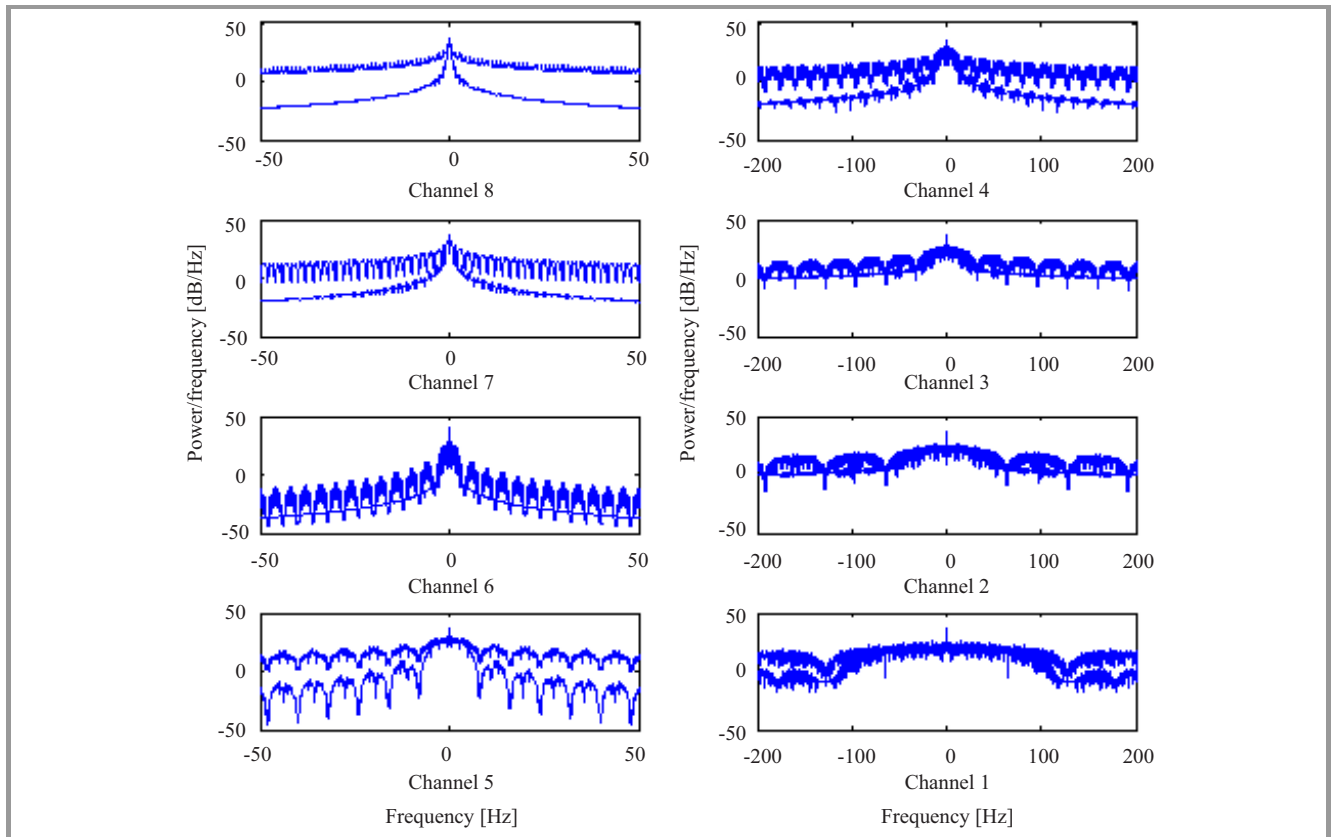
where  $\widehat{S8}$  – evaluation form transmitted in the eighth channel signal, P8 – planning matrix composed of four sample's fragments of the spline, and  $G\_N$  – vector samples of mix group signal and noise (the values that come with the block channel with AWGN).

Based on the obtained evaluation of the transmitted signal's form, a threshold device is used (hard decisions) determining the evaluation of binary values (zero or unity) transmitted in the eighth channel, which is input to the eighth channel's spline interpolator, identical to that used in the transmitter.

The restored copy of the eighth channel signal is subtracted from the signal  $G\_N$ . The difference is input to the next spline filter Savitzky-Golay (SG7), where the procedure is

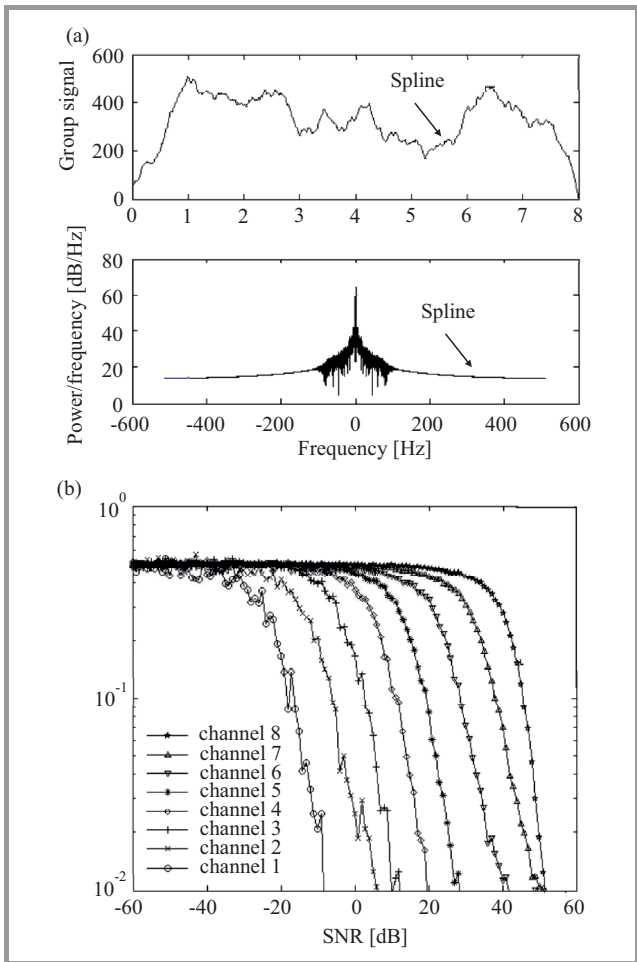


**Fig. 5.** Timing diagrams of signals at the output of the expansion coefficients generator (data) and spline interpolators (sign), for each of the 8 channels (Ch1–Ch8).



**Fig. 6.** The energy spectrum of binary sequences (for all the channels is pictured above) and spline signals of each channel (for all channels is pictured below).

repeated. The only difference is in the planning matrix, which is composed of four fragment of spline seventh channel and the signal difference  $G_N$ .  $G_N$  replaced and restored copies of the 8 signal channel. Thus, binary values are defined in all 8 channels of the system.



**Fig. 7.** Spline signal and its characteristics: (a) the baseband signal (top) and its energy spectrum (bottom), (b) the dependence of the probability error on the SNR for the data transmission system using spline modulation.

On the basis of ten measurements is estimated averaged error probability to each of the eight channels according on the signal to noise ratio (SNR), range from  $-60$  to  $60$  dB, depicted in Fig. 7b. It shows that the probability of error in each channel are not the same and increases with speed. It is the predictable reaction to a different power level and bandwidth of each channel. The presence of local peaks of errors similar to multiple channels is due to an error in lower-speed channel that was not correctly restored and compensated in a certain period of time, resulting in incorrect identification bit (bits) in it. This feature may be reduced by identifying higher average level of the signal at the next channel's input (in this embodiment, this feature still needs more research), or application code protection from errors.

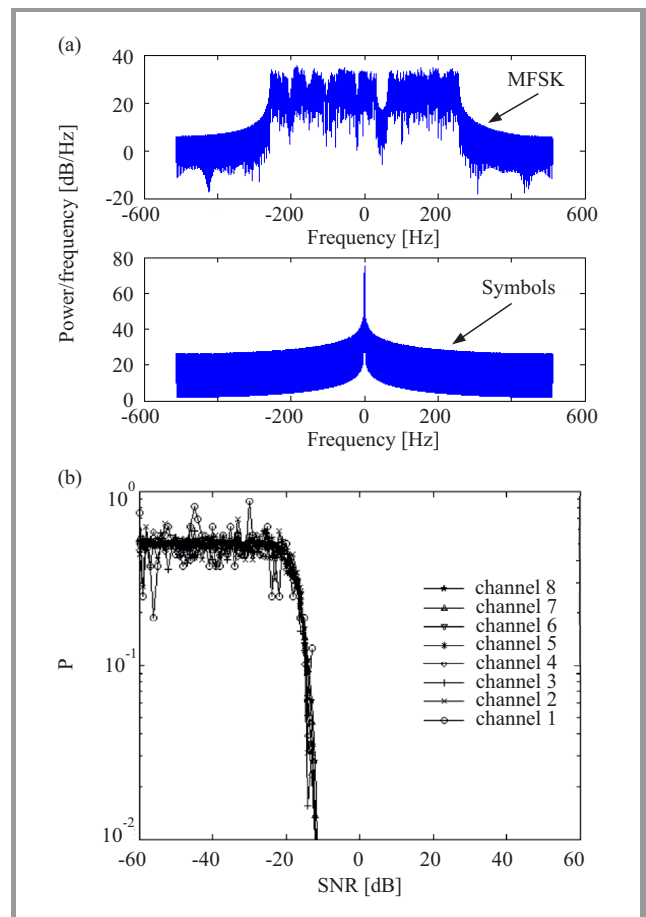
**3.2. Transfer of MFSK**

Consider the transmission of the same data using MFSK modulation with minimum shift. To do this, each of the binary sequences of wavelet decomposition coefficients was seen as a change in the individual bits of the binary bit character with 256-character alphabet. To narrow signal's spectrum, the most high-speed channel corresponds to a smaller value for the discharge character, as shown in Fig. 8.

|       |       |       |       |       |       |       |       |
|-------|-------|-------|-------|-------|-------|-------|-------|
| $2^7$ | $2^6$ | $2^5$ | $2^4$ | $2^3$ | $2^2$ | $2^1$ | $2^0$ |
| x8    | x7    | x6    | x5    | x4    | x3    | x2    | x1    |

**Fig. 8.** Distribution of the expansion coefficients according to categories of characters.

Because the signal changes of x8 are 128 times slower than x1, its value stored (interpolated one and the same value) for transmission of 128 bits of x1 channel. Similarly, for channel x7 (but for transfer 64 bits of x1 channel) and so on.



**Fig. 9.** Characteristics MFSK: (a) the energy spectrum of MFSK (top) and a sequence of characters (bottom), (b) dependence of the error probability on signal to noise ratio for a data transmission system with help of minimum shift MFSK.

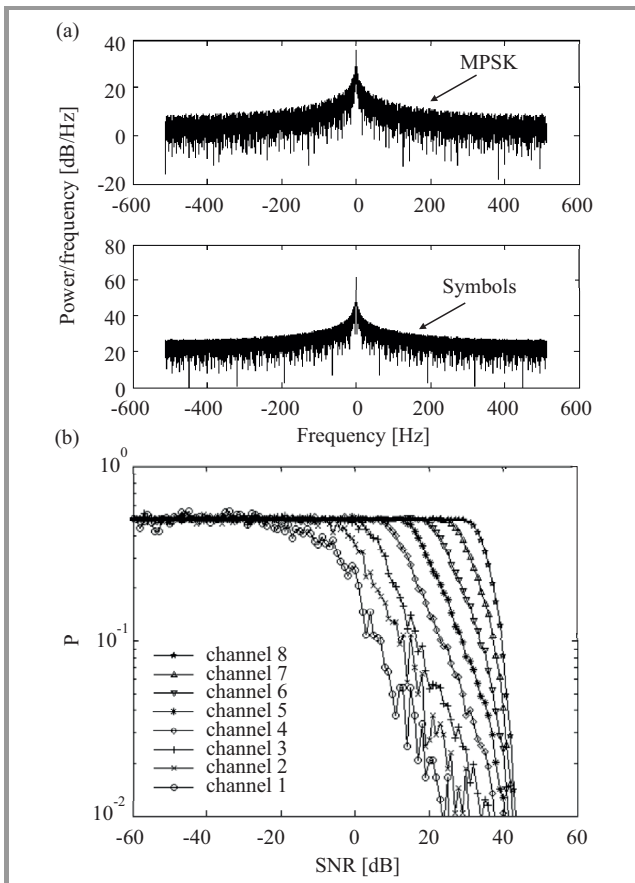
The above-described feature of the wavelet coefficients representation as the data will be preserved when MPSK and MQASK are used.

Figure 9a depicts the energy spectra of MFSK and signal as a sequence of characters having the same sampling rate (1024 Hz) and the number of transmitted bits in the channels on the splines schema. As can be seen the width of the MFSK signal's spectrum is  $n$  times greater (where  $n$  is the number of the alphabet's characters) than the spectrum's width of the symbols sequence, which in turn is determined by the change's rate of bits in the symbol of the most high-speed channel.

The dependence of the error probability on the signal to noise ratio is shown in Fig. 9b. In spite of some bursts in the most high-speed channel, the main form of dependence is almost the same for all channels. Note characteristic for frequency modulated signals resistance to Gaussian noise.

**3.3. Transfer of MPSK**

Consider the transmission characteristics compared to similar signal MPSK modulation. The spectral width of the signal by the zeros of the first lobe in the range of



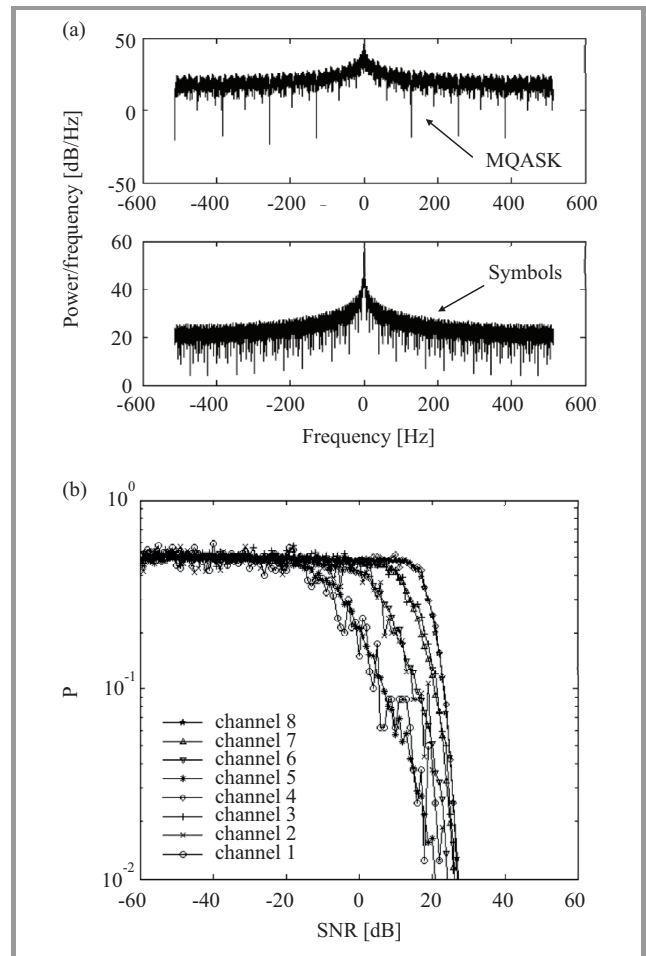
**Fig. 10.** Characteristics of MPSK: (a) the energy spectrum of MPSK (top) and a sequence of characters (bottom), (b) the dependence of the probability of error on the signal to noise ratio for the data transmission system with help of MPSK minimum shift.

256 Hz corresponds to double value of the transfer rate of the fastest channel, 128 bit/s (Fig. 10a).

The dependence of the error probability on the signal to noise ratio between the channels is characterized by uneven curve, as in the spline-system, with decreasing reliability at increasing bit rate (Fig. 10b).

**3.4. Transfer of MQASK**

As for the signal modulation MQASK, its spectrum has the same features as that of MPSK (Fig. 11a), but the dependence of an error probability is specific. Channel pairs 1-5, 2-6, 3-7, 4-8 show almost the same dependence on the signal to noise ratio (Fig. 11b).



**Fig. 11.** Features: (a) power spectrum MQASK (top) and a sequence of characters (bottom), (b) the dependence of the error probability on the signal to noise ratio for the data transmission system with help of MQASK.

**4. Conclusions**

All the considered modulation schemes allow to arrange the values of the decomposition's coefficients, but only in the spline and MPSK modulation during the transmission of the coefficients remains the dependence of their validity and reliability. In this case the spectral width of the first

lobe corresponds to the speed of transmission in most high-speed channel. For MQASK modulation it is observed the irregular dependence of the error probability between the channels, and the spectral width equal to the width of the MPSK spectrum.

The MFSK modulation transmits all coefficients with the same error probability, and requires significantly greater bandwidth than all the other methods of modulation.

In many cases, when transmitting signals from the direct source of information to the receiver in the data collection systems it is rational to simplify the scheme of the transmitter and complexity of the receiver. The use of classical modulation methods for transmission of wavelet coefficients requires additional use of the quadrature modulator, which typically represents a separate functional unit that complicates and increases the cost of the transmitter. Group spline signal can be generated by means of pulse-width modulator, which is common, even in low-cost types of controllers.

Together with built in it analog to digital converter, and a fast algorithm for multiresolution wavelet decomposition, it forms an element of data collection, as suggested in [14] for transmission on two-wire or coaxial cable.

## References

- [1] M. Akay, "Wavelet applications in medicine", *IEEE Spectrum*, vol. 34, no. 5, pp. 50–56, 1997.
- [2] G. Evangelista "Comb and multiplexed wavelet transforms and their applications to signal processing". *IEEE Trans. Sig. Proces.*, vol. 42, no. 2, pp. 292–303, 1994.
- [3] F. Bömers, "Wavelets in real-time digital audio processing: analysis and sample implementations", M.Sc. thesis, Universitat Mannheim, 2000 [Online]. Available: <http://www.boemers.com/personal/thesis.pdf>
- [4] D. V. Beilekchi, "Model' ustroystva peredachi tsifrovogo rechevogo signala po kanalu svyazi", *Metody i Ustroystva Peredachi i Obrabotki Informatsii*, no. 1, pp. 83–89, 2007 (in Russian) [Online]. Available: [http://rts-md.com/docs/archives/MIU\\_07\\_1/chapter%204.pdf](http://rts-md.com/docs/archives/MIU_07_1/chapter%204.pdf)
- [5] A. N. Akansu and R. A. Haddad, *Multiresolution Signal Decomposition: Transforms, Subbands, and Wavelets*. Orlando, FL, USA: Academic Press, 1992.
- [6] T. Edwards, "Discrete wavelet transforms: theory and implementation", *Stanford University*, CA, USA, 1992.
- [7] A. Jamin and P. Mähönen, "Wavelet packet modulation for wireless communications", *J. Wirel. Commun. & Mob. Comput.*, vol. 5, no. 2, pp. 123–137, 2005.
- [8] J. Monera-Llorca and W.-S. Lu, "An improved wavelet-packet-division multiple access system", in *Proc. IEEE Pacific Rim Conf. on Comp. and Sig. PACRIM 1999*, Victoria, BC, Canada, 1999, pp. 495–498.
- [9] W. Z. Zhong and Q. Guo, "Performance evaluation of wavelet packet modulation over mobile satellite channel", *Inform. Technol. J.*, vol. 8, no. 3, pp. 310–317, 2009.
- [10] M. C. Gill, "Coded-waveform design for high speed data transfer over high frequency radio channels", Ph.D. thesis, School of Electronic Engineering, University of South Australia, 1998.
- [11] N. Nikolov and Z. Nikolov, "A communication system with wavelet packet division multiplexing in an environment of White Gaussian Noise and narrow-band interference," *Cybernet. & Inform. Technol.*, vol. 5, no. 1, pp. 100–114, 2005.
- [12] A. I. Kutin, "Mnogokanal'naya sistema peredachi dannykh v spline-ovyykh bazisakh (Multi-channel data transmission system in the spline bases)", *Vesnik Natsional'nogo universiteta "Lvov'skaya politekhnika", Radioelektronika i Telekommunikatsii (Radio electronics and Telecommunications)*, no. 796, pp. 75–82, 2014 (in Ukrainian).
- [13] B. Sklar, *Digital Communications: Fundamentals and Applications*, 2nd ed. Upper Saddle River, NJ, USA: Prentice-Hall, 2001.
- [14] R. Stojanovic and S. Knezevic, "Optimization and implementation of the wavelet based algorithms for embedded biomedical signal processing", *Comp. Sci. & Inform. Sys.*, vol. 10, no. 1, pp. 503–523, 2013.



**Artem I. Kutin** received his M.Sc. in 2009 from the direction of radio engineering and television systems Institute of Air Navigation of National Aviation University (NAU), Kiev, Ukraine. He is currently a lecturer in electronics Krivoy Rog college NAU. He is doing research in the use of splines for data transmission in wired and

cordless communication systems.

E-mail: art-kutin@yandex.ru

Radio Engineering Faculty  
Institute of Air Navigation  
National Aviation University  
Kosmonavta Komarova 1  
03058 Kiev, Ukraine