

Research Paper

Experimental Comparative Investigations to Evaluate Cavitation Conditions within a Centrifugal Pump Based on Vibration and Acoustic Analyses Techniques

Ahmed Ramadhan AL-OBAIDI

Author ORCID ID <https://orcid.org/0000-0003-3819-7008>
Department of Mechanical Engineering, Faculty of Engineering
Mustansiriyah University, Baghdad, Iraq; e-mail: ahmedram@uomustansiriyah.edu.iq

(received April 24, 2019; accepted February 26, 2020)

Cavitation is an essential problem that occurs in all kinds of pumps. This cavitation contributes highly towards the deterioration in the performance of the pump. In industrial applications, it is very vital to detect and decrease the effect of the cavitation in pumps. Using different techniques to analysis and diagnose cavitation leads to increase in the reliability of cavitation detection. The use of various techniques such as vibration and acoustic analyses can provide a more robust detection of cavitation within the pump. In this work therefore, focus is put on detecting and diagnosing the cavitation phenomenon within a centrifugal pump using vibration and acoustic techniques. The results obtained from vibration and acoustic signals in time and frequency domains were analysed in order to achieve better understanding regarding detection of cavitation within a pump. The effect of different operating conditions related to the cavitation was investigated in this work using different statistical features in time domain analysis (TDA). Moreover, Fast Fourier Transform (FFT) technique for frequency domain analysis (FDA) was also applied. Furthermore, the comparison and evaluation system among different techniques to find an adequate technique incorporating for accuracy and to increase the reliability of detection and diagnosing different levels of cavitation within a centrifugal pump were also investigated.

Keywords: centrifugal pump; cavitation; Fast Fourier Transform; vibration; acoustic; normalise features.

1. Introduction

Over the last few decades, centrifugal pumps have been extensively used in numerous types of applications such as agriculture, plants of wastewater treatment, gas and oil industry, food industry, and power plants (AL-OBAIDI, 2018). Cavitation is commonly attributed to be one of the main causes of deterioration in the performance of centrifugal pumps that operate at high flow rates and high rotational speeds (AL-OBAIDI, 2019a). The analysis of diagnosing cavitation phenomenon within a centrifugal pump and detection its level of severity (inception and development of cavitation) is very essential aspect in order to improve maintenance and enhance reliability of the pump. Early detection of cavitation phenomenon that could occur in the pump, is therefore necessary to perform significant preventative actions. Hence, it needs continuous condition monitoring in order to increase the operation life of the pump and decrease the cost of

maintenance. Faults or damages in pumps cause many problems in industry such as leakage, abnormal high level of the noise and vibration, damage parts of the pump and hence, cause breakdown of all system that leads to essential losses of time and money. Therefore, the main aims of the research presented in this study are to determine the pump performance and predict the cavitation phenomenon within a centrifugal pump. In this research work, different techniques were used in order to achieve various forms of results, and to increase the reliability of detection of cavitation within a centrifugal pump such as vibration and acoustic. Due to the combined use of these techniques, our work can provide a more robust detection of cavitation. In the literature, many researchers have attempted experimentally to investigate and discuss the pump performance with and without cavitation using various conditioning monitoring methods. ZHANG *et al.* (2015) did one of these studies where authors attempted to study the vibration features in the centrifugal pump that

has a special slope in the volute. The results showed that the vibration level of slope volute pump was lower than the conventional pump under different frequency. Therefore, it was proven that using slope volute pump can efficiently decrease the vibration level in the centrifugal pump. STOPA *et al.* (2012) detected incipient cavitation in the centrifugal pumps using a tool known as Load Torque Signature Analysis (LTSA). Their results revealed that the LTSA tool presents a response pattern close to those normally shown by vibration and pressure sensors when used in such an application. CHUDINA (2003) used noise as an indicator in investigating cavitation phenomenon within the centrifugal pump. In his work, the author carried out analysis of the noise signal in frequency domain under different operating conditions. The results showed that the cavitation increases at high flow rate particularly at the high range of frequency. CERNETIC *et al.* (2008) detected and monitored of cavitation in the pump by using vibration and noise signals. They used two types of centrifugal pumps. First one was closed impeller with six blades and made of metal alloy, the second one was semi-open impeller with six blades and made of plastic material. Outcomes showed that each pump has various spectra, vibration and noise levels with various discrete frequencies. In addition, they found that the difference between vibration and noise under cavitation and non-cavitation conditions was between 10 to 15 dB. ALBARIK *et al.* (2012) investigated and diagnosed centrifugal pump faults through the use of vibration approach. The results showed that, when the flow rate increases the level of vibration increases as well. SUHANE (2012) studied the effect of radial clearance on pressure pulsations by using vibrations and noise signals in the centrifugal pump under different flow rates and radial clearances between impeller and diffuser of 1.5 mm, 3.7 mm, and 6.8 mm, respectively. Result indicated that at low flow rate both vibration and noise levels are low, and are high when the flow rate is also high. Moreover, the vibration and noise levels were minimum at the maximum radial clearance between impeller and diffuser. In addition, from experimental outcomes author observed that when the value of radial clearance increases, the lower pressure fluctuations occur. FAROKHZAD *et al.* (2013) experimentally investigated the relationship between vibration signal and the type of fault within the centrifugal pump under different operating conditions using a condition monitoring system. They collected vibration signals from the pump using the accelerometer, which was positioned on the bearing of the shaft. The results showed an important change in the trend of vibration signal as a function of fault at various operating conditions. The value of RMS for healthy pump conditions was moderate and stable, but the increased in value due to the broken impeller and faulty seal. LUO *et al.* (2015) researched on statistical features of vibration signals

in the centrifugal pump. The results showed that when the pump worked under flow instability conditions, the dynamic characteristics of the pump were changed. Therefore, the statistical analysis of vibration signal (probability density factor PDF, Standard deviation, and Kurtosis) could be a useful technique of predicting unstable flow in the pump. The statistical features of vibration signal in time domain and frequency domain are a good indicator for predicting intensity changes and the onset of cavitation in the pump. GUPTA *et al.* (2003) detected cavitation in the centrifugal pump using the sound signal from the microphone. Their results showed that when cavitation becomes fully developed, the sound level goes to a higher level compared without cavitation. The noise occurrence on the pump depends on the flow rate, speed of the pump and the instability of the pump. SAKTHIVEL *et al.* (2010) conducted an investigation about the usage of a set of statistical features for diagnosing faults in the centrifugal pumps such as kurtosis, standard deviation, skewness, variance, range, the maximum value and minimum value. Their study for faulty conditions comprises of impeller faults as well as bearing faults making their outcome becoming a promising method for diagnosing practical fault application in centrifugal pump. Tan and Leong (2008) experimentally studied detection of cavitation in the centrifugal pump using vibration signals. They tested the pump under three operating conditions including BEP, 90% of BEP, and 80% of BEP. Their results showed that the vibration amplitude increased significantly under cavitation when compared to normal operating condition. The possible reason for this increase was due to the amplitude of the vibration during cavitation because of the formation and collapse of bubbles particularly at the eye of the impeller. MCCORMICK and NANDI (1997) examined the usage of artificial neural networks (ANN) to monitor the rotating machinery condition from the time series of vibration. The assumption of extracting methods is based on the zero lag higher-order statistics applicable to both horizontal and vertical vibration time series. The feedback of adaptive learning and momentum technique is utilized for training the ANN. The outcomes from such method showed that the combination of moments of the complex time series with its acquired derivative moments could help in the achievement of detecting fault successful by more than 90%. AL THOBIANI *et al.* (2010) studied the cavitation phenomena in the centrifugal pump through the use of acoustic and vibration approach. The outcome of their study revealed that kurtosis and peak factors are not sufficient for indicating cavitation phenomenon in the centrifugal pump. However, their finding recommends that spectral entropy is more accurate for detecting cavitation. ČUDINA and PREZELJ (2009) detected the cavitation in pumps using discrete audible spectra frequency. The level of the spectra frequency peak was in-

creased with the inception of cavitation, which further increased, with the development of the cavitation and it reached a maximum value when the cavitation process was fully developed within the pump. NASIRI *et al.* (2011) analysed the vibration signal for detecting cavitation phenomena in centrifugal pumps by using neural networks. They introduced three monitoring conditions such as normal, developed and fully developed cavitation in the pump. In order to test such network, they used the feed forward back propagation. Their finding revealed the reliability of the method to detect cavitation in the pump. ZARGAR (2014) detected cavitation within the centrifugal pump related to oil industry for cooling circulation water system. The author found that the vibration amplitude in time and frequency analysis was suddenly increased under cavitation conditions as compared to the one without cavitation. This phenomenon leads to a decrease in the performance of the pump.

Detailed experimental investigations have been carried out over a wide range of operation conditions. Rigorous statistical features have been used to analyse the variations in the vibration and acoustic signals from the centrifugal pump. This study presents results of a comparative experimental work on the vibration and acoustic techniques for condition monitoring at different operation conditions. The effectiveness of the vibration and acoustic techniques is presented through the use of signal processing method, using different statistical features resulting from the time domain analysis (TDA), and then convert the time domain to frequency domain analysis (FDA) using FFT approach. Furthermore, the analyses of the above features are performed using MATLAB code. The results that were obtained using the above-mentioned techniques showed the reliability and effective the proposed methodology to detect the different levels of cavitation severity occurrence within a pump. It can be clearly found from experimental measurement that when the cavitation occurs within the pump, it causes direct decrease in the pump performance and hence, when the cavitation continues to increase, it leads to decrease or closing of flow passage through the pump as well as increase the level of vibration and noise. As a result it causes erosion at the parts of the pump especially at the impeller and volute, which then causes failure of the pump. Therefore, it is significant to find an effective tool to detect cavitation in the pump in order to monitor and attempt to decrease it, and hence to keep the pump operating at high performance and also extend a life of the pump. The results show that both vibration and acoustic techniques are more effective in predicting the cavitation phenomenon in the pump based on different operation conditions. However, the vibration technique was more sensitive to detect cavitation as compared to acoustic technique. Furthermore, using vibration and acoustic techniques to monitor the

different levels of cavitation can prevent the deterioration of the pump, and decrease the maintenance costs (BACHUS, CUSTODIO, 2003; OKADA *et al.*, 1995; JENSEN, DAYTON, 2000; SMITH, KRAENZLER, 2017; AL-OBAIDI, 2019b).

2. Techniques for detecting cavitation

As explained in previous sections it is obvious that there are several signs that indicate the inception and development of cavitation in the centrifugal pumps such as decrease in the performance of the pump and increase in the level of vibration and noise.

2.1. Experimental vibration analysis

The centrifugal pump detection and diagnostic cavitation using vibration and acoustic techniques were experimentally analysed in this study using condition monitoring system (CMS), and a brief explanation of these techniques is presented in this section. Recently, there are different types of condition monitoring approaches that have been used and developed, for example airborne acoustics, vibration, lubricant, acoustic emission, motor current, voltage and temperature analysis techniques, etc. Vibration technique is widely used in different types of machines for fault detection (AL-OBAIDI, 2019c). It is easy to use and measure as well as it is sensitive for diagnosing the fault in the machine and it can be used for wide range of frequencies and temperatures, and hence using vibration technique for condition monitoring systems for different applications is effective (TIAN, 2017). The condition monitoring system through the use of vibration signal consists of six main parts as shown in Fig. 1. These parts are the machines under investigation such as turbines, compressors, pumps, the vibration sensor (accelerometer), data acquisition system for collecting data. The PC for saving data, the interface software programme between the data acquisition and user in order to see the vibration signal, and the final part is using a software such as MATLAB code to analyse data and signal processing (AL-OBAIDI, 2020; DEVI *et al.*, 2010).

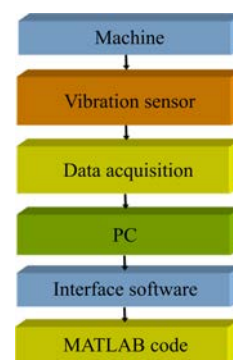

Fig. 1. Flow chart diagram of the experimental methodology for the vibration signal processing.

2.2. Experimental acoustic analysis

Acoustic technique has become widely used in different fields such as psychology, engineering, physics, music, speech, neuroscience, and others. In general, the sound is produced due to several various processes for example, vibrating, changing in airflow, supersonic flow, and friction between parts, etc., (AL-OBAIDI, 2019d; SCHROEDER *et al.*, 2007). The acoustic technique has several advantages, e.g. it can be used to collect data from the machine under different temperatures and different operation conditions, and it can be used to detect different types of faults in the machines directly during operation conditions. Usually, the existence of cavitation can be simply heard through normal listening. What signifies this approach is that it is based on measurement of sound pressure, which is simple and logical.

3. Experimental setup

The main aims of this study are to determine the pump performance and detect cavitation in the centrifugal pump experimentally. The detection of cavitation experimentally was achieved by using different techniques such as vibration through the use of accelerometer sensor and acoustic technique by using microphone sensor as well as pressure using two pressure transducers at suction and discharge of the pump under the different range of operation conditions (AL-OBAIDI, 2019e). To achieve these aims experimentally, it was essential to construct and design an appropriate experimental setup for the centrifugal pump. The designing of this experimental setup is discussed in more details in the next section.

Figure 2 presents the different parts for the flow loop of experimental setup of the centrifugal pump. The centrifugal pump can supply water to the tank with a maximum pressure about 10 bar. The selected flow loop system was re-circulatory and included

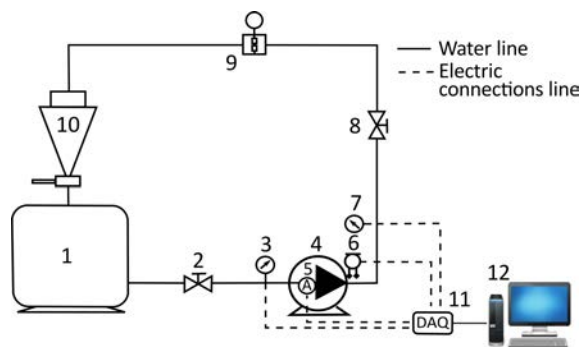

Fig. 2. Experimental setup components and flow loop system: 1 – water tank, 2 – suction valve, 3 – suction pressure transducer, 4 – centrifugal pump, 5 – accelerometer sensor, 6 – microphone sensor, 7 – discharge pressure transducer, 8 – discharge valve, 9 – water flow meter, 10 – hopper, 11 – data acquisition system, 12 – PC.

a plastic water tank, PVC clear pipe and PVC connections components. The tank capacity was based on the maximum flow rate. The inlet pipe diameter of the pump was 2 inches. Also, the outlet pipe diameter of the pump used is 1.25 inches. Thus, a reducing coupling of 1.25 to 1.5 inches was used to connect the outlet pipe to the water flow meter line because the diameter of water flow meter was 1.5 inch. The tank was made of plastic with dimensions of $95 \times 90 \times 110$ cm. The entire section pipes was a transparent pipe, to facilitate observation when the cavitation occurs. There are several reasons behind selecting the latter type of pipe. Firstly, the clear pipes are easier to install. Secondly, they are easy to connect and thirdly they are low cost as compared to the stainless-steel pipes. Furthermore, the PVC pipes do not necessarily demand complicated tools to be used in connecting the different pipes together, as the entire connections between pipes are made using a solvent welding type (solvent cement and cleaning fluid). However, the PVC clear pipes have some disadvantages such as lack of rigidity. The connections of the flow loop of the centrifugal pump and the water tank were made through use of various sizes of PVC pipes (AL-OBAIDI, TOWSYFYAN, 2019).

3.1. Sensors types for monitoring systems

Different kinds of sensors used for detecting and measuring the physical parameters in order to monitor machine condition are presented below:

- **Vibration Accelerometer:** The accelerometer type IEPE model CA-YD-1182 was used at the outlet volute near tongue region. The accelerometer range of frequency is between 0 Hz to 15 kHz and the operation temperatures range between -40 and $+120^\circ\text{C}$.
- **Acoustic (Microphone):** A microphone was used in order to monitor and obtain more information regarding the cavitation. A free-field accurate microphone model CHZ-223 was employed for gaining the acoustic signal.
- **Microphone Pre-amplifier YG-201:** The second important part of the microphone is the preamplifier (type YG-201 ICP). Microphone preamplifier helps to condition the output signal. The operating temperature range of this pre-amplifier is between -40°C and $+85^\circ\text{C}$, the power requirements are between 2 to 20 mA with nominal power of 4 mA.
- **Pressure Transducers:** To measure the maximum pressure at the discharge pipe the measurement was carried out by the pressure transducer made by Impress Control (model number IMP-G5000-6A4-BCV-03-000). The pressure range on this transducer is between 0 to 10 bar. To measure the low pressure at the suction pipe, another pressure transducer was used (Impress

Control, model number IMP-G1002-7A4-BCV-03-000), having different pressure range from 0 to 5 bar. The operating temperature for both transducers is between -20 to $+80^{\circ}\text{C}$ with accuracy of less than $\pm 0.25\%$, with supply voltage of between $9-32$ V DC.

- Water Flow Meter: The water flow meter model TM150 from GPI was chosen, the $1\frac{1}{2}$ inch TM series water flow meter.
- Thermometer: A dual channel temperature type K thermocouple with backlight LCD thermometer was used in this experimental work.
- Data Acquisition System: The type of data acquisition used in this study is Voltage/IEPE (Integrated Electronics Piezo Electric) data acquisition system (USB 2.0) YE6232-16 channels, from Global Sensor Technology (GST) made by Sinocera.

During each experimental test, for the vibration and acoustic signals sampling process, the pump rotation speed was kept constant at the different flow rates. In these experimental measurements, each experimental test was repeated at least 3 times. In order to obtain and provide more reliable consistent data sets, collecting and repeating each operation test helped to comprehend the characteristics of the vibration and acoustic signals. Hence, acquire more dependable diagnostic features for predicting cavitation within the pump. This study collects and then analyses the vibration and acoustic signals under various flow rates. At the input, the voltage signal obtained from the accelerometer and acoustic signal were collected, then sampled at 96 kHz in the data acquisition system. Furthermore, the numbers of data points in each of these experimental measurements were equal to $2\,880\,000$ points.

3.2. Conventional statistical measures from the time domain analysis

In this study we used conventional statistical measures to analyse signal that was obtained from time domain by using the statistical features below:

- Analysis of data using the peak value of the signal: It is an important statistical parameter and is used to calculate the peak value of the signal (AL THOBIANI, 2011).
- Analysis of data using root mean square (RMS) value: The RMS value of the signal is employed widely in condition monitoring for machines in order to indicate the energy level of the signal. Further, this statistical feature is used to evaluate the effect of signal fluctuations in any machine (KAMIEL, 2015).
- Analysis of data using the peak-to-peak value of the signal: This is an important statistical parameter and represents the distance from the minimum peak to maximum peak of the signal.

- Analysis of data using variance value: The fourth statistical parameter that was used in this study is to measure and analyse signals that are obtained from time domain variance value (KAMIEL, 2015).
- Frequency domain analysis: The Fast Fourier transform technique is extensively used to transform the signal from time domain into the frequency domain on the assumption that the frequency elements of the signal are always directly related to the mechanical condition of the machine components. The Fourier transform produces a frequency spectrum, which is the average of the signal over the sampling period. The outcome of the Fast Fourier transforms offers the amplitude of the signal with frequency (KAMIEL, 2015).

3.3. Conventional statistical measures from the frequency domain analysis

For further analysis, this work used different conventional statistical information to analyse signals that were obtained from frequency domain by using following statistical values:

- Analysis of data using the mean value of the signal: The mean value of a signal is denoted by the Greek symbol μ , it represents the average value (SMITH, 1997).
- Analysis of data using root mean square (RMS) value: The RMS can be calculated from frequency domain (spectrum), representing the value from zero to 70.7% of the maximum (peak) amplitude for the spectrum.

In order to calculate the NPSH in this study, the experimental data for Net Positive Suction Head required (H-NPSHR) curve of the centrifugal pump that was provided by its manufacturer (Pedrollo company pump model F32/200H) and the NPSHA can be calculated under several operational conditions as follows (AL-OBAIDI, 2019e):

$$\text{NPSHA} = \frac{P_{\text{atm}} + P_s}{\rho g} + \frac{V^2}{2g} - \frac{P_v}{\rho g} - H_i,$$

where P_{atm} , P_s , V , P_v , H_i are the atmospheric pressure, suction pressure, velocity, vapour pressure and head losses, respectively. Also, ρ and g are the water density and gravitational acceleration.

3.4. Cavitation as an important source of vibration and noise in the centrifugal pump

When cavitation occurs in the different types of machines (e.g. propellers, turbines, and various kinds of pumps), it causes drop in pressure particularly at the eye of impeller below the water vapour pressure and as a result can lead to increase in the level of noise and vibration due to unstable flow which causes increase in the pressure fluctuations within a pump (HERNANDEZ-SOLIS, 2006).

3.5. Effect of various flow rates to predict the performance and cavitation within a centrifugal pump

The second main aim in this research is to predict and diagnose the cavitation phenomenon within a centrifugal pump experimentally using different techniques such as vibration and acoustic techniques as mentioned earlier. Vibration technique was used in order to predict cavitation. For analysis purpose, the effects of various flow rates on the performance of the pump to predict cavitation within a pump were investigated in this section. The centrifugal pump operated experimentally at different flow rates (three stages of flow rates). The first stage was at low flow rate, and the second stage was at design flow rate and the last stage was at high flow rate as summarised in Table 1. Keeping pump rotational speed $N = 2755$ rpm constant. The next section presents the results of the pump performance and predicted cavitation obtained from experimental calculation based on the different flow rates. Table 1 summarises wide range of flow rates that was investigated in order to predict the performance and cavitation.

3.6. Calculation of the head and NPSH of the centrifugal pump under various flow rates

Figure 3 depicts the head of the pump under various flow rates measurements which is also summarised in Table 1 with a pump rotational speed of $N = 2755$ rpm. that the figure shows the changes in the pumps' flow structure as flow rate increased from lower to the higher value. It is worth noticing here the change of head in the pump. It can be observed that the trend of head gradually decreases when flow rate

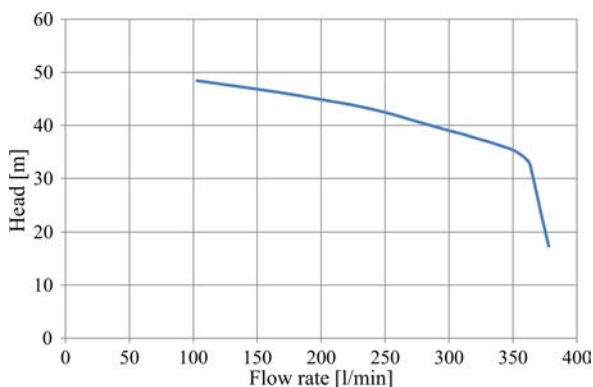

Fig. 3. Head of the centrifugal pump under pump rotational speed 2755 rpm.

increases. Moreover, from this figure, it can be seen that the head changes in a periodic manner as the pressure changes in the pump. There are three possible reasons. The first one is due to the high interaction between the impeller and tongue volute region which is generated by the impeller rotational speed. The second reason is related to the non-uniform distribution of pressure distribution in the volute due to the asymmetrical cross-section area of the volute. Finally, the important reason is the occurrence of inception and development of cavitation within the pump. Moreover, it can be also seen from this figure that when the pump operates under high flow rate, it leads to decrease in the head within the pump and then also leads to reduction in the pressure at the inlet eye of the impeller below the water vapour pressure. Hence, it causes cavitation phenomenon, and it would develop in the pump when the flow rate is increased. Further investigation also shows that the head rapidly decreases when the pump operates at flow rate higher than 350 l/min. This is due to the occurrence and development of cavitation.

The cavitation characteristics of the centrifugal pump that are monitored as important part of this study are plotted in Fig. 4. This figure depicts the Net Positive Suction Head available, and Net Positive Suction Head required against different flow rates based on inception and development of cavitation in the pump (STOPA *et al.*, 2012). For this purpose, the pumps' flow rate can be changed through progressively throttling the discharge valve and then keeping the suction valve open at 100% and keeping the pump rotational speed constant at 2755 rpm. The manufacturers (Pedrollo company pump model F32/200 H) provided the experimental data for the H-NPSHr curve for the centrifugal pump.

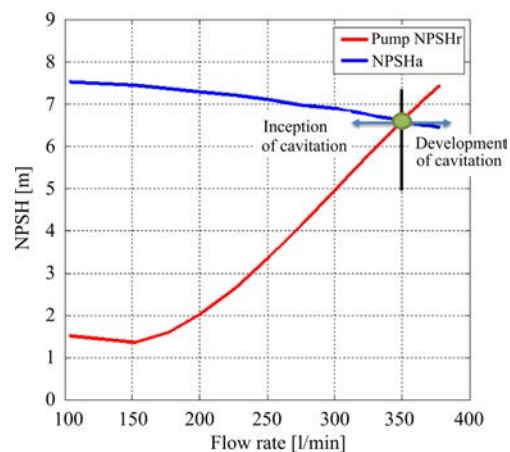

Fig. 4. The cavitation characteristics of the centrifugal pump under different flow rates.

Table 1. Range of flow rate for the pump under pump rotational speed of 2755 rpm.

Range of flow rate [l/min]																
378	370	365	362	352	342	331	320	310	302	276	252	227	200	177	152	103

From Fig. 4, the different regions of cavitation are quite apparent. The first one was when the pump works under low flow rate making no cavitation to occur in this region. At this point, the NPSHa is higher than the NPSHr. For the second region, the flow rate is higher than 350 l/min and at this region, cavitation begins to occur in the pump where the intersection between the two curves for NPSHa and NPSHr already occurred. That means the development of cavitation starts at this point. The third important region is when cavitation within the centrifugal pump starts to increase as the flow rate increases more than 350 l/min due to decrease in the pressure at the eye of the impeller below the water vapour pressure and hence, at this point, the NPSHa becomes smaller than the NPSHr. Also, it is clear that the signs of cavitation include deteriorating of the performance of the pump. Additionally, during the experimental measurements for the centrifugal pump, inception of cavitation rapidly deteriorates at the flow rate higher than design flow rate as shown in Fig. 6. In addition, it can be seen from this figure that cavitation occurs at flow rate between higher design flow rate range of 300 l/min and 350 l/min. It can be clearly seen that the level of cavitation is increased with the flow rate increase.

3.7. Condition monitoring of the cavitation using vibration and acoustic techniques

Condition monitoring in pumps has become a significant application as it can extend the life of the pump as well as decrease the cost of maintenance. In this research, a methodology is proposed to detect the inception and development of cavitation within the centrifugal pump. Methodology discussed in this work is based on the vibration signal analysis in both time and frequency domain under different operation conditions. Figure 5 depicts the flow chart analysis of the vibration data for detecting cavitation within the pump. The vibration analysis methodology was suggested for detecting the inception and development of cavitation within a centrifugal pump. Based on signal processing monitoring system through the use of vibration signal, under a wide range of operation conditions. Such conditions include different flow rates, pump rotational speeds, and decrease in the suction valve openings and the air injections. The methodology used in this research consists of different stages. The brief details of these experimental stages are as follows:

- Collecting the experimental test measurements of the raw vibration signals from the centrifugal pump under the different ranges of operating conditions using accelerometer.
- Analysing the vibration signal based on time domain (TD). Firstly, comparison of the various raw vibration signals under the different operation conditions using the graph of the time wave-

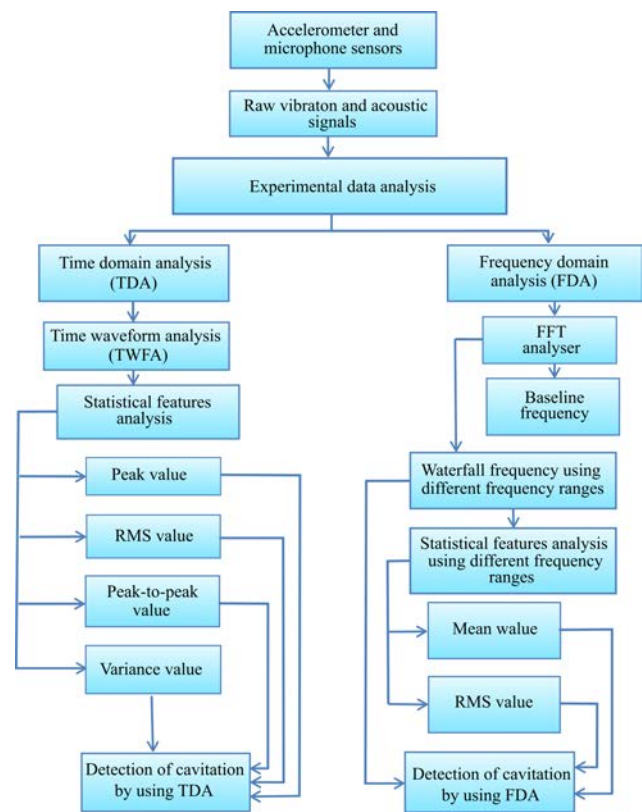

Fig. 5. Flow chart analysis of data processing.

form analysis (TWFA). Secondly, analysis of the vibration signal by using different statistical features such as peak, RMS, peak-to-peak and variance features.

- Detecting various levels of cavitation (no cavitation, inception, development, and full development of cavitation) within a pump by using above features.
- Comparing between above mentioned features to find the sensitive feature in order to detect different levels of cavitation.
- Analysis of the vibration signal based on frequency domain (FD) using FFT technique firstly, analysis of the raw vibration signal based on various frequency ranges (low and high-frequency ranges).
- Finding the sensitive frequency range for detecting different levels of cavitation in the pump using waterfall figures (three-dimensions figures) to compare between vibration signal under different conditions.
- Analysing the amplitude of the vibration signal under different frequency ranges and wide range of operating conditions based on frequency domain (FD) using different statistical features such as mean and RMS vibration amplitudes.

- Detecting different levels of cavitation (no cavitation, inception, development, and fully development of cavitation) within a pump by using above features.
- Comparing between above features in order to find the sensitive frequency range in frequency domain analysis (FDA) in order to detect different levels of cavitation within a pump. Furthermore, all above stages were processed using MATLAB code.

3.8. The vibration and acoustic signals analysis based on time domain (wave form) under various flow rates

In the time waveform analysis (TWFA) of vibration acceleration signal was compared under normal

and cavitation operating conditions. The experimental results were depicted and grouped based on different flow rates. The cavitation phenomenon within a pump can be detected using condition monitoring system by time waveform analysis (TWFA). Different vibration waveform signals collected by accelerometer sensor that was mounted on the centrifugal pump casing are illustrated in Figs 6 and 7. These figures depict the relation between the amplitude and time for the vibration waveform signals under various flow rates for different operation conditions, i.e. normal operation conditions without cavitation and abnormal operation conditions with cavitation (see Table 1) and pump rotational speed of 2755 rpm. It can be seen from these figures that there are different levels of vibration and acoustic amplitudes according to the change in

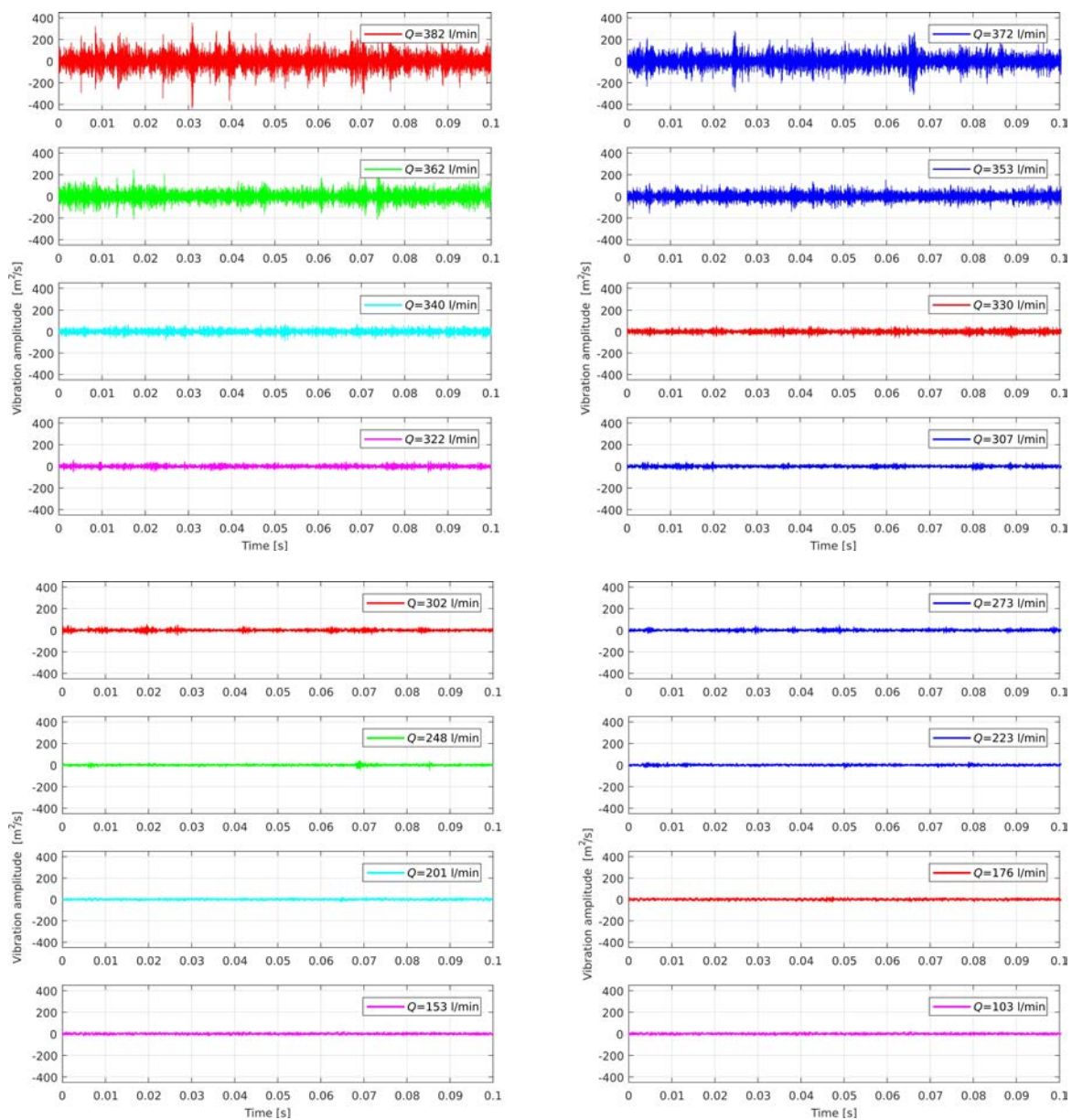

Fig. 6. Different vibration signals under various capacities of flow rates at 2755 rpm.

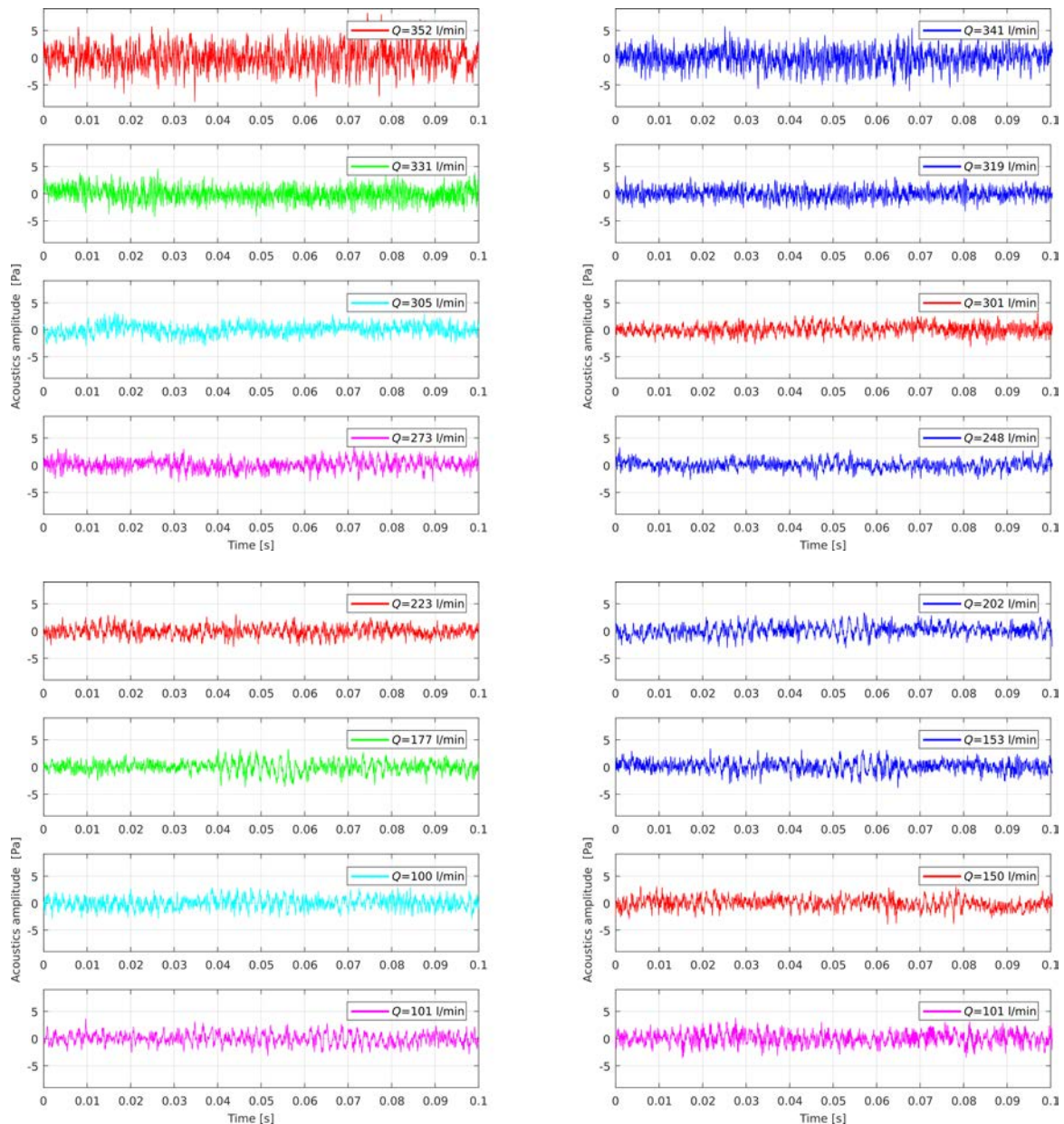

Fig. 7. Different acoustic (microphone) signals under various capacities of flow rates.

the flow rate. For example, when the pump works under the low range of flow rate, the levels of vibration and acoustic amplitudes are almost the same. It is also worth noticing that at a low range of flow rate the levels of vibration and acoustic amplitudes are lower than that when the pump operates under high flow rate. However, at the high range of flow rate the vibration and acoustic levels begin to increase. Obviously, at the range of flow rate from 362 to 378 l/min the values of vibration and acoustic amplitudes rapidly increase, the results depict that the vibration amplitude and acoustic signals increase with flow rates increase. Two possible reasons can be considered to explain this phenomenon. The first one is due to the high interaction

between the impeller and volute tongue region, such interaction occurs particularly in this region due to two important reasons. Firstly, when the trailing edge blades of the impeller are near and then they crossed the tongue region during rotation of the impeller, and secondly, when the tongue area is between two trailing edge blades of the impeller. The second main reason to increase the vibration and acoustic amplitudes is mostly due to the incipient cavitation phenomenon taking place at the high flow rate, and it develops when the flow rate is increased. In this case, the trend for the vibration and acoustic amplitudes is more random with high peaks when compared with normal operating conditions.

3.9. Cavitation detection index (CDI)

Cavitation detection index (CDI) is used to compare the vibration and acoustic results to obtain more information and to find sensitive technique for detecting the inception and development of cavitation within a centrifugal pump under different wide ranges of operation conditions. The detection of cavitation index (CDI) technique was used for the analysis purpose. The simple meaning of this technique is to use normalise features by dividing actual values of statistical features to the maximum values in time domain analysis (TDA) such as peak, RMS, peak-to-peak, and variance. As well as mean and RMS values in frequency domain analysis (FDA). More details for normalised results are presented in following section.

3.10. Effect of different flow rates

In order to find the sensitive technique for detecting cavitation within a centrifugal pump, comparison between the vibration and acoustic techniques in time and frequency domain analysis under different flow rates using detection of cavitation index (CDI) technique was performed, as presented in the next sections.

3.10.1. Detection of cavitation in time domain analysis using different normalise features under different flow rates

Figure 8 depicts the detection index normalise results of (peak/peak max., RMS/RMS max., peak-to-peak/peak-to-peak max., and variance/variance max.) values for both vibration and acoustic signals under different flow rates start from 100 l/min to 370 l/min. The pump rotational speed of 2755 rpm. It can be clearly seen that all above features for both vibration and acoustic results have approximately the same trends. There is no significant change in values of the above mentioned features when the pump operates under flow rate lower than 350 l/min. However, the rapid increase occurs at a flow rate higher than 350 l/min. One of the main reasons is the higher interaction between the water and blades of impeller. The other reason is high interaction between the impeller and the volute, particularly at tongue region. Finally, the most important reason is due to the effect of the occurrence of cavitation under flow rate higher than design flow rate. Figures 6 and 7 show that all vibration features are more sensitive to detect inception of cavitation as compared to acoustic signal, the trends of these features start to increase after design flow rate of 300 l/min. However, the statistical features for acoustic signal start to increase after 350 l/min. Additionally, the cavitation normalises values for vibration results of (peak/peak max., RMS/RMS max., and peak-to-peak/peak-to-peak max.) values identify the inception of cavitation detection 20% lower. While

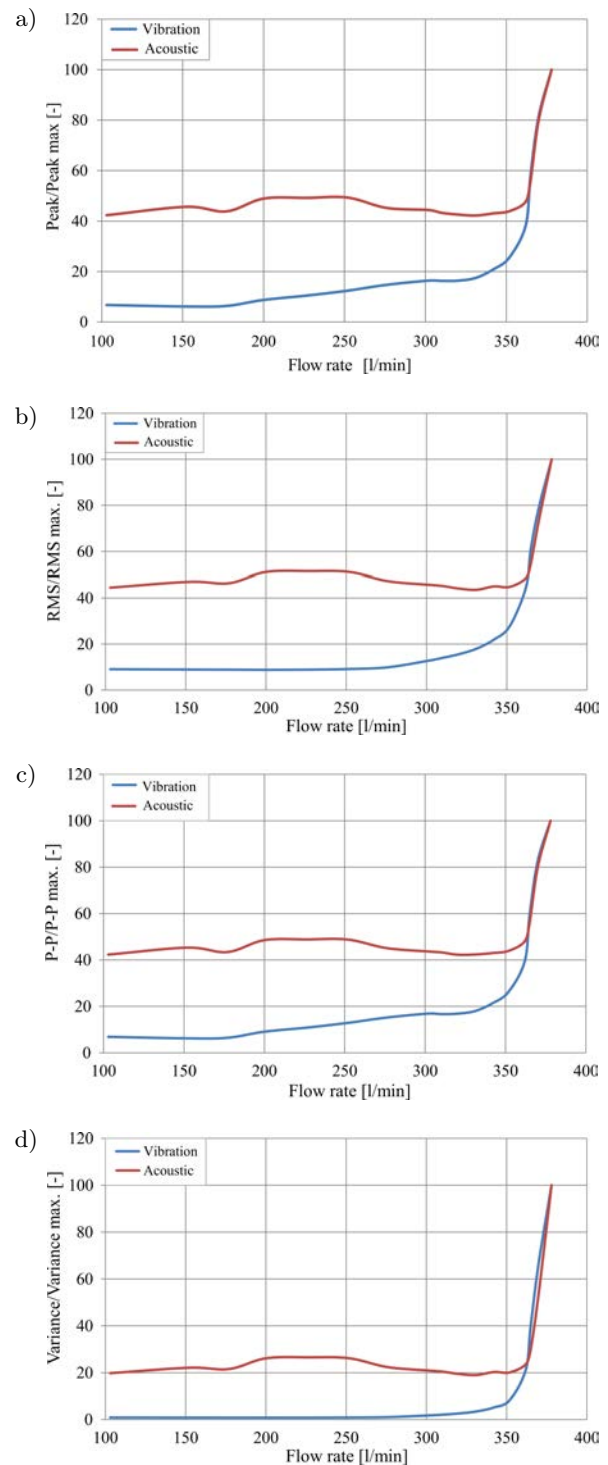

Fig. 8. Normalise results of (peak/peak max., RMS/RMS max., peak-to-peak/peak-to-peak max., and variance/variance max.) values for the vibration and acoustic signals.

acoustic results values identify inception cavitation 40% higher. However, the (variance/variance max.) value for the vibration technique results was 10% and for acoustic technique results approximately 20%. So, the above values of vibration and acoustic results can be used as a threshold to detect different levels of cavitation. It can also be seen that as the threshold in-

creases, the level of cavitation increases within centrifugal pump. Furthermore, it can be concluded that the use of (peak/peak max., RMS/RMS max., peak-to-peak/peak-to-peak max., and variance/variance max.) values to analyse vibration signal was more sensitive to detect inception and development of cavitation as compared to an acoustic signal. However, the acoustic signal was sensitive for detecting development of cavitation. In addition, the use of different normalise statistical features in time domain analysis (TDA) can become a good indication regarding detection of cavitation within a centrifugal pump using both techniques.

3.10.2. The analysis of vibration and acoustic signals based on frequency domain under various flow rates

Several experimental measurements were carried out to measure the vibration signal. To analyse further, frequency domain analysis was carried out in studying the effect of the different measurements of the flow rates on the vibration amplitude. For this purpose, the three-dimensional figure was used in this section. This figure allows comparing more than one vibration amplitude signal in frequency domain and hence it shows how the vibration amplitude changes within the centrifugal pump under various operation conditions. For this purpose, in order to study the effect and sensitivity of using different frequency ranges and also to analyse, detect and then diagnose the inception and development of cavitation within the centrifugal pump vibration signal in frequency domain is used. The range of broadband frequency is divided into four main parts to obtain an apparent conception concerning the dominant frequencies in the pump: the first part deals with a low range of broadband frequency starting from 0 Hz to 1 kHz, the second part deals with range of broadband frequency is starting from 1 kHz to 2 kHz, the third part starts from 2 kHz to 10 kHz, and the final part from 10 kHz to 15 kHz as illustrated in the next section.

3.10.3. Predict the cavitation within a pump at frequency range from 0 Hz to 2 kHz

Figures 9 and 10 depict the three-dimensional figure of vibration and acoustic signals in the frequency domain based on the different range of frequencies. The first one is at low range frequency from 0 Hz to 1 kHz and the second one is at range of frequency between 1 kHz and 2 kHz under various measurements of flow rates (see Table 1) and the rotational impeller speed of 2755 rpm. Both figures clearly show that there are small variances in the level of vibration and acoustic amplitudes within the centrifugal pump when the pump operates less than 300 l/min. However, it can be also observed that there is a significant increase in the level of vibration and acoustic amplitudes that occurs when the pump is operated under flow rate higher

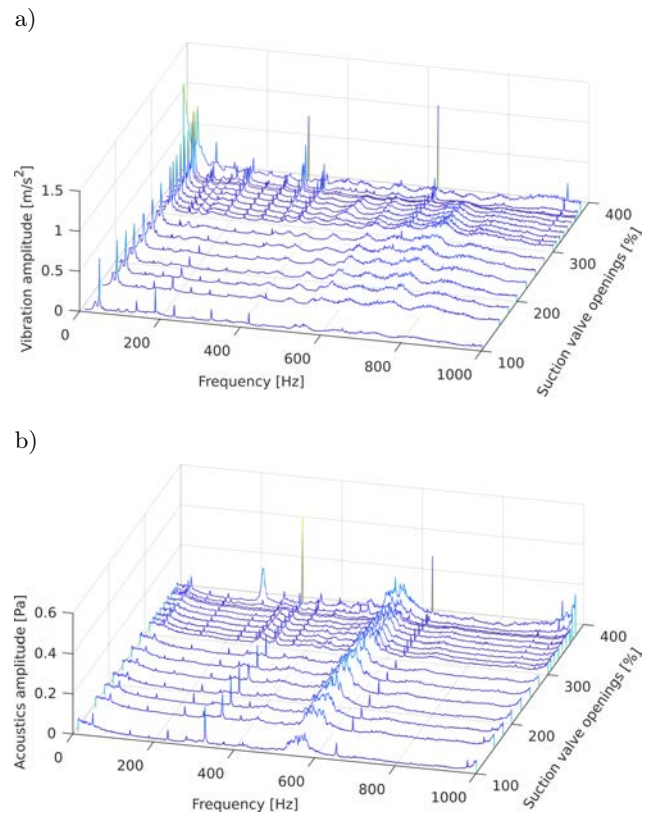

Fig. 9. Frequency domain under various flow rates.

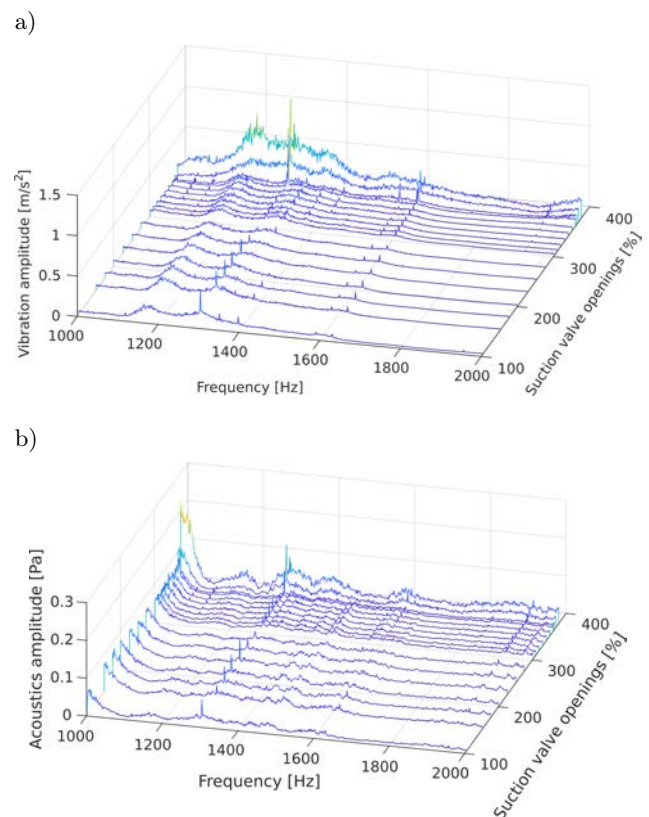

Fig. 10. Frequency domain under various flow rates and the frequency range from 1 kHz to 2 kHz at 2755 rpm.

than 350 l/min. It can be noticed that this increase in the level of vibration and acoustic amplitude occurs for both range frequencies from (0 Hz to 1 kHz) and (1 kHz to 2 kHz), respectively. It is due to the high interaction between water and the blades of the impeller, as well as the interaction between the impeller and volute. Moreover, another important reason is the occurrence of cavitation within the pump.

Also, from this figure, it is worth observing that under flow rate higher than 350 l/min, the development of cavitation has already occurred. This is due to the smaller vapour bubbles generated in and around the impeller passages and hence, the bubbles impeding the flow rate being pumped. As a result, these bubbles cause increase in the level of vibration and noise inside the pump which then result in a decrease in performance of the pump. Therefore, a decrease in the pump performance is a reliable indication of cavitation that occurred in the pump. In addition, the dominated frequencies for both frequency ranges are associated with the shaft rotating frequency (Rf), blade passing frequency (BPF) and their harmonics. Furthermore, as mentioned in this section, it can be observed that the level of the vibrations was closely related to the occurrence of cavitation in the pump.

3.10.4. Predict the cavitation within a pump at frequency range from 2 Hz to 15 kHz

Figures 11 and 12 depict the three-dimension vibration and acoustic signals in frequency domain analysis (FDA) and the frequency range is from 2 Hz to 10 kHz and 10 Hz to 15 kHz, under various flow rates and the pump rotational speed of 2755 rpm. It can be seen that these range of frequencies have the same trends as compared to previous figures for level of vibration and acoustic amplitudes in frequency domain under flow rate less than 350 l/min. However, the trend of vibration and acoustic amplitudes increases when flow rate increases; it is also worth observing that the vibration and acoustic amplitudes under high flow rates have much higher intensities as compared to the low flow rate due to the occurrence of the inception of cavitation at the flow rate lower than 350 l/min. After the inception of cavitation occurs, variations in the level of vibration and acoustic amplitudes increase as flow rate increases. When the cavitation increases continuously, it means the pump operates under the conditions of fully developed cavitation, leading to the level of increased amplitudes in vibration and acoustic signals, particularly under higher flow rate. Because of the occurrence of cavitation in the pump, bubbles begin to form and collapse within the pump which directly affect the level of the vibration amplitude. Furthermore, it can be observed that high-frequency range was more sensitive for detecting cavitation particularly at high flow rate as compared to low-frequency range.

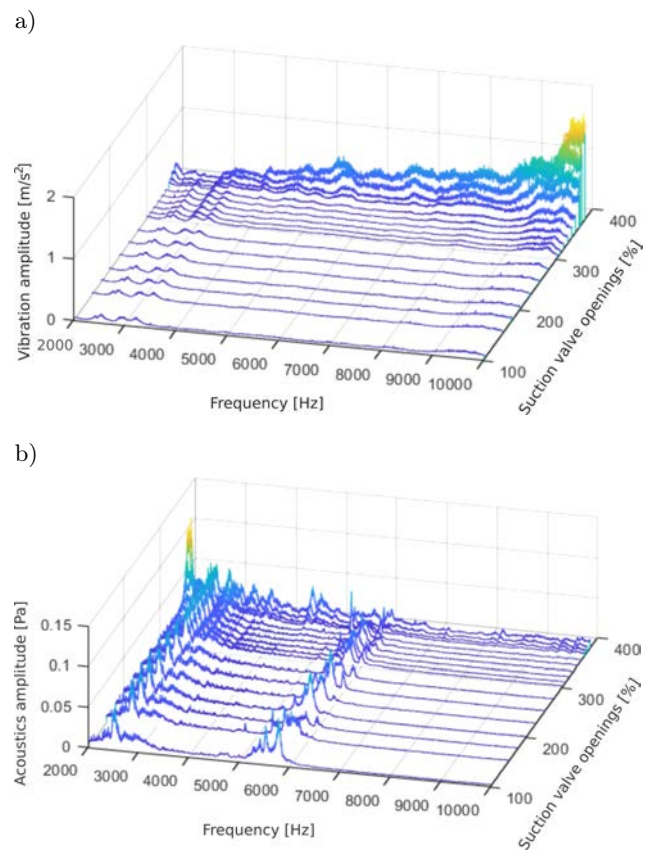

Fig. 11. Frequency domain under various flow rates.

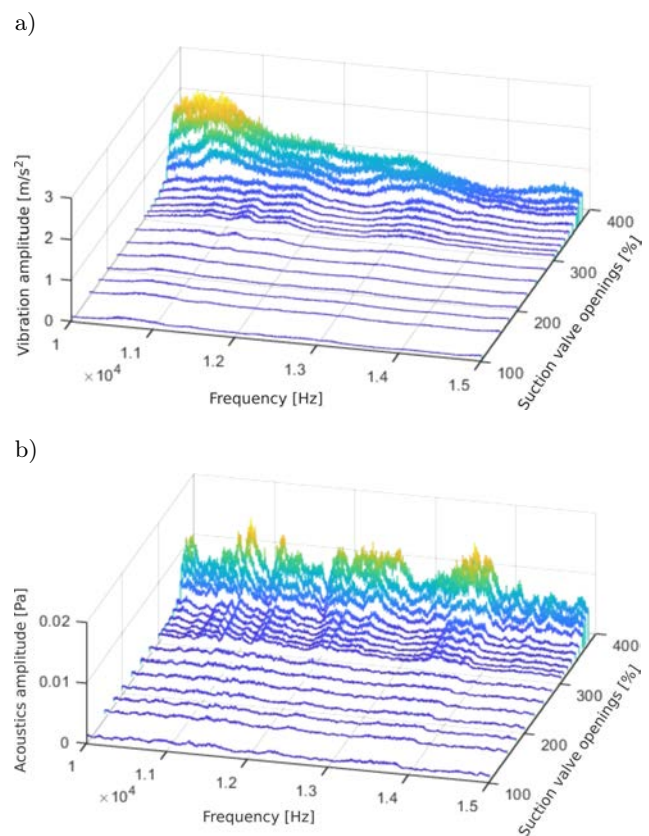

Fig. 12. Frequency domain under various flow rates and the frequency range from 10 Hz to 15 kHz.

3.10.5. Detection of cavitation in frequency domain analysis using different normalise features under different flow rates

In the similar manner, Fig. 13 depicts the normalise results of (mean/mean max.) value for the vibration and acoustic signals in frequency domain under differ-

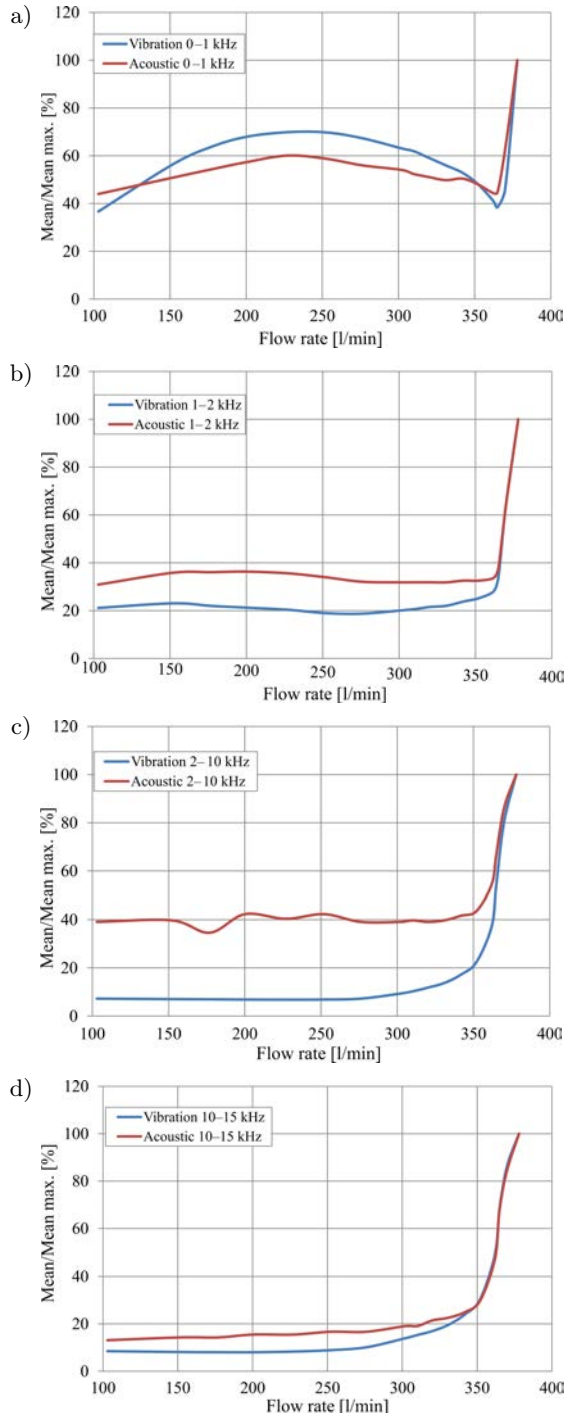

Fig. 13. Normalise results of (mean/mean max.) value in frequency domain for the vibration and acoustic signals under different flow rates and at 2755 rpm for different range of frequencies: a) 0–1 kHz, b) 1–2 kHz, c) 2–10 kHz, and d) 10–15 kHz.

ent flow rates from 100 l/min to 370 l/min. The pump rotational speed of 2755 rpm and for various range of frequencies (0–1 kHz), (1–2 kHz), (2–10 kHz), and (10–15 kHz) respectively. It can be observed that the features mentioned above for both vibration and acoustic results have approximately the same trend. There is no significant change when the pump operates under flow rate lower than 350 l/min, but the rapid increase is seen at a flow rate higher than 350 l/min due to the above mentioned reasons. Additionally, it can be seen that from above findings that the vibration sensor (accelerometer) provides a suitable indication for detecting inception occurrence of cavitation within a pump under a wide range of flow rates and frequency ranges as compared to acoustic signal using microphone sensor. The acoustic technique was not capable of capturing entire changes within pump, particularly small changes that the vibration technique was able to capture. Furthermore, it can be observed that the frequency range 10 kHz to 15 kHz was more sensitive for detecting inception of cavitation for both techniques (vibration and acoustic). Since, there are many vibration and acoustic amplitudes peaks in this frequency range as compared to other frequency ranges. Moreover, in both techniques it was observed from previous sections of this work that the frequency ranges of 1–2 kHz are sensitive to detect cavitation. Therefore, sensors with low frequency range can be used to detect inception of cavitation. Additionally, using lower frequency range sensors can decrease the overall cost. The cavitation normalises results of (mean/mean max.) value for the vibration identifies the inception of cavitation detection for the frequency range of 1–2 kHz, the cavitation normalised results for vibration and acoustic techniques were 20% and 30% higher, respectively. However, for frequency range of 2–10 kHz, the cavitation normalised results for vibration and acoustic techniques were 20% and 40% ,respectively. Furthermore, frequency range 10–15 kHz is lower than 18% and 20% respectively. So, the normalised values of (mean/mean max.) results for vibration and acoustic as threshold can be used to detect cavitation. Also, when this threshold increases, it can be said that level of cavitation has increased within centrifugal pump.

Therefore, it can be concluded that the analysis of vibration signals using normalisation (mean/mean max.) of frequency values was more sensitive to detect inception of cavitation as compared to an acoustic signal. In addition, the analysis of vibration and acoustic signal using above normalised feature for high-frequency range was more sensitive to detect the inception and development of cavitation. Based on above results it can be concluded that the use of (mean/mean max.) value for different frequency ranges in frequency domain analysis (FDA) can be a good indication regarding detection the inception and development of cavitation within a centrifugal pump.

The experimental measurements were converted from time domain to the frequency domain to obtain more indications regarding detection of cavitation in the pump through signal processing. Figure 14 depicts the normalised results of (RMS/RMS max.) value for the vibration and acoustic signals in fre-

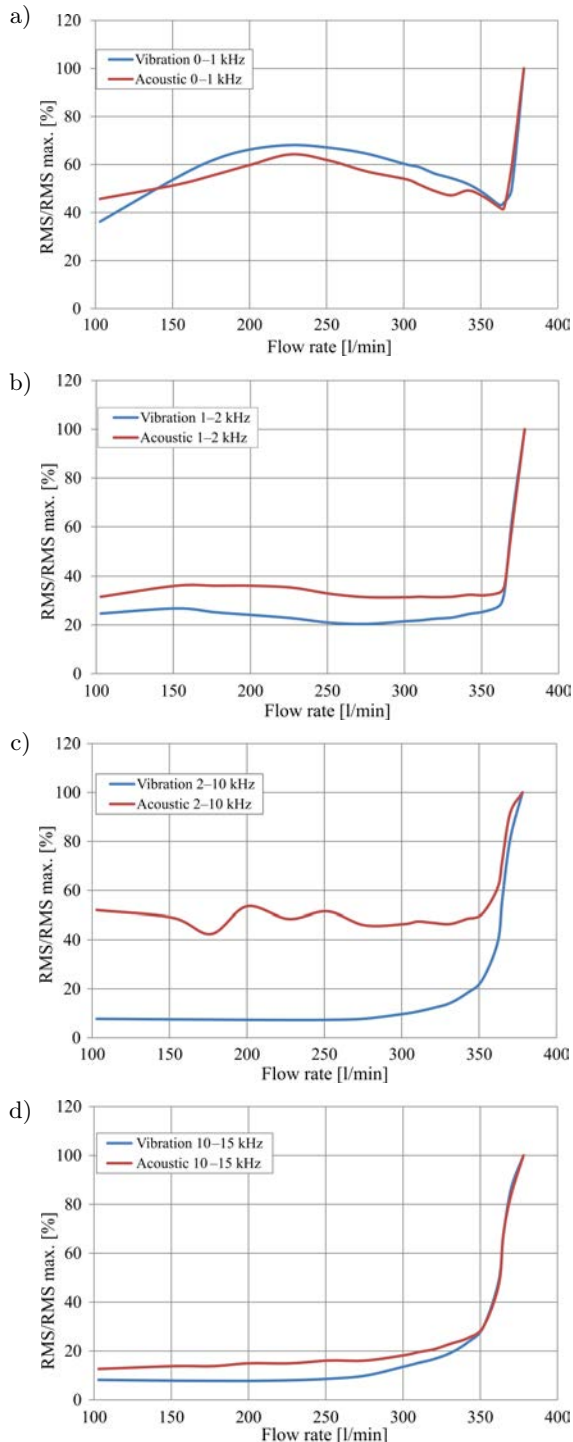

Fig. 14. Normalise results of (RMS/RMS max) value in frequency domain for the vibration and acoustic signals under different flow rates and at 2755 rpm for different range of frequencies: a) 0–1 kHz, b) 1–2 kHz, c) 2–10 kHz, and d) 10–15 kHz.

quency domain under different flow rates, pump rotational speed of 2755 rpm and for the different range of frequencies. It can be observed that the (RMS/RMS max.) value for the vibration and acoustic signals have approximately the same trend of (mean/mean max.) value in previous figures. It can be observed that from the vibration and acoustic signals that the normalised (RMS/RMS max.) values under cavitation condition at high flow rate are higher than without cavitation (normal operation conditions) at low flow rate, and the severity of cavitation is increased with the flow rate increase. The cavitation normalised values of (RMS/RMS max.) for vibration and acoustic techniques follow approximately same trend of cavitation detection index as compared to (mean/mean max.) values in the previous figures.

Based on above results, it can be concluded that the use of (mean/mean max.) and (RMS/RMS max.) values to analyse the vibration and acoustic signal in frequency domain under different flow rates and frequency ranges can provide useful information regarding detection of cavitation in the pump. Hence, to find the sensitive frequency ranges for this purpose.

4. Conclusions

Based on above results in this section, several conclusions were drawn regarding the effect of different flow rates and pump rotational speeds on the vibration signal and performance of the centrifugal pump.

- 1) The trend head of the centrifugal pump gradually decreases when flow rate is increased due to the hydraulic and mechanical losses as well as different levels of cavitation.
- 2) The level of cavitation within a centrifugal pump is directly linked with the pump flow rate and as the flow rate increases, cavitation level also increases.
- 3) Under cavitation process, the vapour bubbles increase due to decrease of the fluid pressure, lower than the vapour pressure. Moreover, they have high effects on the flow within a pump. The inception of cavitation process mostly occurs at the eye of the impeller around or closed to the impeller blades leading edges. The levels of cavitation extend increasingly on the impeller passages as the flow rate increases. Hence, at the occurrence of a fully developed cavitation, strong turbulent flow patterns also occur at the impeller blade passages which is the main reason why unstable flow occurs, which then increases the pressure fluctuation at the inlet of the pump and in turn, leads to increase in the level of vibration and noise.
- 4) The peak and peak-to-peak feature values were the most sensitive to detect cavitation within a pump when compared to RMS and variance features.

- 5) The pump generates two main dominant frequencies. The first one was associated with the shaft rotating frequency (Rf) and the second one was the blade passing frequency (BPF) and their harmonics under different flow rates and various pump rotational speeds.
- 6) The use of features such as mean and RMS vibration amplitude values to analyse the vibration signal in frequency domain provides more information regarding the prediction of cavitation within a centrifugal pump.
- 7) Flow characteristics change, resulting in cavitation at higher flow rates that then leads to changes in different vibration response.
- 8) The use of detection index normalise features such as (peak/peak max., RMS/RMS max., peak-to-peak/peak-to-peak max., and variance/variance max.) features for both vibration and acoustic signals in time domain analysis (TDA) can be proved a good indication regarding detection different levels of cavitation within a centrifugal pump under different operation conditions.
- 9) The vibration and acoustic techniques are sensitive to detect cavitation but vibration technique was more sensitive as compared to acoustic technique under different operation conditions.
- 10) It can be seen that the results of normalise features for the vibration amplitude at a flow rate between 100 and 350 l/min were lower than the results of normalise features for the acoustic amplitude. However, the vibration and acoustic amplitudes were rapidly increased after 350 l/min due to the development of cavitation within a centrifugal pump. Furthermore, it can be observed that the increase in level of flow rate range higher than 350 l/min increases the level of vibration and acoustic amplitudes to the maximum value.
- 11) The use of normalise features in time domain analysis (TDA) and frequency domain analysis (FDA) for different frequency ranges can provide a good indication regarding detection inception and development of cavitation within a centrifugal pump.
When the occurrence of cavitation starts to increase within a pump then its development leads to increasing of the level of vibration and acoustic amplitudes and reach the maximum values at fully development of cavitation.
- 12) The analysis of vibration and acoustic signals provides good indication regarding when the pump operates under safer operation conditions (without cavitation) as well as under different levels of cavitation conditions.
- 13) The frequency range 1–2 kHz for both vibration and acoustic results was sensitive to detect cavitation as compared to the frequency range 0–1 kHz

under different operation conditions. Therefore, sensors with low-frequency range can be used for detecting cavitation, and hence it can decrease the cost of sensors as compared to sensors with high-frequency range.

Acknowledgements

The author would like to thank Mustansiriyah University (www.uomustansiriyah.edu.iq) Baghdad – Iraq for its support in the present work. The author also wishes to gratefully acknowledge the financial support by the Ministry of Higher Education and Scientific Research (Iraq). The measurement data and the pump geometry was a part of my PhD degree at University of Huddersfield (UK).

References

1. AL THOBIANI F. (2011), *The non-intrusive detection of incipient cavitation in centrifugal pumps*, University of Huddersfield, UK, <http://eprints.hud.ac.uk/id/eprint/14576>.
2. AL THOBIANI F., GU F., BALL A. (2010), The monitoring of cavitation in centrifugal pumps based on the analysis of vibro-acoustic measurements, *CM and MFPT*, 11 pages. <http://eprints.hud.ac.uk/id/eprint/8182>.
3. AL-OBAIDI A. (2018), *Experimental and numerical investigations on the cavitation phenomenon in a centrifugal pump*, Doctoral dissertation, University of Huddersfield, UK, <http://eprints.hud.ac.uk/id/eprint/34513>.
4. AL-OBAIDI A.R. (2019a), Effects of different turbulence models on three-dimensional unsteady cavitating flows in the centrifugal pump and performance prediction, *International Journal of Nonlinear Sciences and Numerical Simulation*, **20**(3–4): 487–509, doi: 10.1515/ijnsns-2018-0336.
5. AL-OBAIDI A.R. (2019b), Experimental investigation of the effect of suction valve opening on the performance and detection of cavitation in the centrifugal pump based on acoustic analysis technique, *Archives of Acoustics*, **44**(1): 59–69, doi: 10.24425/aoa.2019.126352.
6. AL-OBAIDI A.R. (2019c), Investigation of effect of pump rotational speed on performance and detection of cavitation within a centrifugal pump using vibration analysis, *Heliyon*, **5**(6): e01910, doi: 10.1016/j.heliyon.2019.e01910.
7. AL-OBAIDI A.R. (2019d), Monitoring the performance of centrifugal pump under single-phase and cavitation condition: A CFD analysis of the number of impeller blades, *Journal of Applied Fluid Mechanics*, **12**(2): 445–459, doi: 10.29252/jafm.12.02.29303.
8. AL-OBAIDI A.R. (2019e), Numerical investigation of flow field behaviour and pressure fluctuations within an axial flow pump under transient flow pattern based

- on CFD analysis method, *Journal of Physics: Conference Series*, **1279**: 012069, doi: 10.1088/1742-6596/1279/1/012069.
9. AL-OBAIDI A.R. (2020), Detection of cavitation phenomenon within a centrifugal pump based on vibration analysis technique in both time and frequency domains, *Experimental Techniques*, 1–19, doi: 10.1007/s40799-020-00362-z.
 10. AL-OBAIDI A.R., TOWSYFYAN H. (2019), An experimental study on vibration signatures for detecting incipient cavitation in centrifugal pumps based on envelope spectrum analysis, *Journal of Applied Fluid Mechanics*, **12**(6): 2057–2067, doi: 10.29252/jafm.12.06.29901.
 11. BACHUS L., CUSTODIO A. (2003), *Know and understand centrifugal pumps*, Elsevier, doi: 10.1016/B978-1-85617-409-1.X5000-2.
 12. CHUDINA M. (2003), Noise as an indicator of cavitation in a centrifugal pump, *Acoustical Physics*, **49**(4): 463–474, doi: 10.1134/1.1591303.
 13. ČUDINA M., PREZELJ J. (2009), Detection of cavitation in operation of kinetic pumps. Use of discrete frequency tone in audible spectra, *Applied Acoustics*, **70**(4): 540–546, doi: 10.1016/j.apacoust.2008.07.005.
 14. DEVI S. *et al.* (2010), A comparative study between vibration and acoustic signals in HTC cooling pump and chilling pump, *International Journal of Engineering and Technology*, **2**(3): 273–277 <http://www.ijetch.org/papers/133-T478.pdf>.
 15. FAROKHZAD S., BAKHTYARI N., AHMADI H. (2013), Vibration signals analysis and condition monitoring of centrifugal pump, *Technical Journal of Engineering and Applied Sciences*, p. 1081.
 16. HERNANDEZ-SOLIS A. (2006), *Diagnosis of Centrifugal Pumps*, Msc. Thesis XR-EE-EME 2006:05 Department of Electrical Machines and Power Electronics School of Electrical Engineering Royal Institute of Technology.
 17. JENSEN J., DAYTON K. (2000), Detecting cavitation in centrifugal pumps, *ORBIT*, Second quarter, pp. 25–30.
 18. KAMIEL B.P. (2015), *Vibration-based multi-fault diagnosis for centrifugal pumps*, PhD Thesis, Curtin University, <https://pdfs.semanticscholar.org/8dcc/12bd4bdad23d6cbaed50375bb1ef343a30fc.pdf>.
 19. LUO Y., SUN H., YUAN S.Q., YUAN J.P. (2015), Research on statistical characteristics of vibration in centrifugal pump, *Technical Journal of the Faculty of Engineering*, **38**(1): 49–61, <http://www.tjfeonline.com/admin/archive/603.04.20151428074108.pdf>.
 20. McCORMICK A., NANDI A. (1997), Classification of the rotating machine condition using artificial neural networks, *Proceedings of the Institution of Mechanical Engineers, Part C: Journal of Mechanical Engineering Science*, **211**(6): 439–450, doi: 10.1243/0954406971521845.
 21. NASIRI M., MAHJOOB M., VAHID-ALIZADEH H. (2011), Vibration signature analysis for detecting cavitation in centrifugal pumps using neural networks, *IEEE International Conference on Mechatronics (ICM)*, pp. 632–635, doi: 10.1109/icmech.2011.5971192.
 22. OKADA T., IWAI Y., HATTORI S., TANIMURA N. (1995), Relation between impact load and the damage produced by cavitation bubble collapse, *Wear*, **184**(2): 231–239, doi: 10.1016/0043-1648(94)06581-0.
 23. SAKTHIVEL N., SUGUMARAN V., BABUDEVASENAPATI S. (2010), Vibration based fault diagnosis of monoblock centrifugal pump using decision tree, *Expert Systems with Applications*, **37**(6): 4040–4049, doi: 10.1016/j.eswa.2009.10.002.
 24. SCHROEDER M., ROSSING T.D., DUNN F., HARTMANN W.M., CAMPBELL D.M., FLETCHER N.H. (2007), *Handbook of Acoustics*, Springer.
 25. SMITH P., KRAENZLER T. (2017), Reducing effects of corrosion and erosion, *World Pumps*, **2017**(2): 38–41, doi: 10.1016/S0262-1762(17)30033-0.
 26. SMITH S.W. (1997), *The scientist and engineer's guide to digital signal processing*, California Technical Publishing.
 27. STOPA M.M., FILHO B.J.C., MARTINEZ C.B. (2012), Detection of incipient cavitation phenomenon in a centrifugal pump, *2012 IEEE Industry Applications Society Annual Meeting*, Las Vegas, NV, doi: 10.1109/IAS.2012.6374080.
 28. SUHANE A. (2012), Experimental study on centrifugal pump to determine the effect of radial clearance on pressure pulsations, *Vibrations and Noise, International Journal of Engineering Research and Applications*, **2**(4): 1823–1829.
 29. TAN C.Z., LEONG M.S. (2008), An experimental study of cavitation detection in a centrifugal pump using envelope analysis, *Journal of System Design and Dynamics*, **2**(1): 274–285, doi: 10.1299/jsdd.2.274.
 30. TIAN X. (2017), *Enhanced information extraction from noisy vibration data for machinery fault detection and diagnosis*, PhD Thesis, University of Huddersfield, Huddersfield: UK, <http://eprints.hud.ac.uk/id/eprint/31440>.
 31. ZARGAR O.A. (2014), Detecting cavitation in a vertical sea water centrifugal lift pump related to iran oil industry cooling water circulation system, *International Journal of Mechanical, Aerospace, Industrial, Mechatronic and Manufacturing Engineering*, **8**(1): 124–129, doi: 10.5281/zenodo.1090721.
 32. ZHANG N., YANG M., GAO B., LI Z. (2015), Investigation on vibration characteristics in a centrifugal pump with special slope volute, *Advances in Mechanical Engineering*, **7**(2): 936218, doi: 10.1155/2014/936218.