

PASSING-BEAM HEADLAMPS AND THE POSSIBILITIES OF ASSESSMENT OF ROAD OBSTACLES BY A DRIVER AT NIGHT

TOMASZ TARGOSIŃSKI¹, YANDAN LIN²

Motor Transport Institute
Fudan University Shanghai

Summary

In most cases, passing beam is used when this is required because of the current traffic conditions. Due to the necessity of limiting the dazzling effect, the passing beam is divided into two parts: the lower one ("light"), which is to illuminate the road correctly and over as long a distance ahead of the vehicle as possible, and the upper one ("shadow"), which is to inform about the presence of a moving vehicle on the road. The headlamps must be precisely aimed to obtain the maximum range of road illumination with limited dazzle.

The minimum requirements for passing beam have been laid down in type-approval and operational regulations. Based on the maximum acceptable range of headlamp aiming tolerances as specified in UN ECE Regulation No. 48, the illuminated road length ahead of the vehicle may vary from 20 m to 200 m. If the operational tolerances (i.e. those applicable to vehicles during normal operation) are taken as a basis, this variability range may be even wider. On the other hand, the photometric characteristics of the light beam close to the road surface depend on the said requirements, on the photometric characteristics of the headlamps actually installed on the vehicle, and on the actual headlamp aiming and alignment.

From the traffic safety point of view, a matter of great significance for a vehicle being in use is the actual distance to which the road is illuminated. This issue is also important in the case of a need for accident reconstruction. The factors that affect the road illumination range, which is critical for the detection of road obstacles, have been analysed herein, with taking into account the measurements and calculations carried out for real headlamps that can be found in vehicles as well as the possible values of the vertical inclination and horizontal deflection of the light beam. Conclusions drawn from an assessment of the current state of laws and technologies have also been presented.

Keywords: passing beam, road illumination, road traffic safety

1. Introduction

Accident statistics show that the road accident risk at dawn, at twilight, and after dark is about doubled in comparison with that encountered during the daytime. What is more,

¹ Motor Transport Institute, ul. Jagiellońska 80, 03-301 Warszawa, Poland, tel. +48 22 4385157, e-mail: tomasz.targosinski@its.waw.pl

² Fudan University Shanghai 220 Handan Road, Shanghai 200433, China, e-mail: ydlin@fudan.edu.cn

the risk of death, if an accident happens, is about four times as high. In a significant part, the accidents consist of collisions with pedestrians or obstacles. On the other hand, the reasons for accidents are similar, according to the statistical data: failing to yield the right of way, excessive speed, alcohol, etc. The accidents reported by experts as caused by defects in the vehicle lighting system are ranked very low. This shows that the safety factor related to the vehicle lighting is difficult for being unequivocally evaluated and verified. There is a belief that if a vehicle had a valid roadworthiness certificate at the time of an accident then the road must have been satisfactorily illuminated, which translates into a statement that the accident was caused by the driver because "he/she failed to keep the vehicle speed in conformity with traffic conditions" or by another non-technical factor. However, a detailed analysis of specific accidents that took place at night can indicate that the performance of the vehicle lighting system, especially the actual road illumination range, which could be accountable for delayed detection of an obstacle, might have played an important role. Therefore, the vehicle lighting is aptly considered as one of the major elements contributing to the active safety of road traffic.

Wherever used in this paper, the term "headlamps", which are sometimes referred to as "headlights" or "projector headlights", will have the meaning of lighting fittings used to emit light beams (passing beam, driving beam, fog light beam, etc.) along the road ahead of the vehicle. This term covers:

- driving-beam headlamps, used when no preceding or oncoming vehicles are present on the road;
- passing-beam headlamps, used in the other situations;
- front fog lamps, used in bad weather conditions (in case of reduced visibility).

Furthermore, headlamp versions of more developed construction, i.e. adaptive passing-beam headlamps (AFS = Adaptive Front-lighting System) and automatic/adaptive driving-beam (ADB) headlamps, can be used as well.

2. Night-time road accidents

From time to time, the public learns about fatal road accidents that took place after dark. Usually, the information open to the public has rather general nature. A few examples are given below.

On 26 Dec. 2013, a road accident took place at Promna Kolonia on road No. 7, on the carriageway towards Warsaw. A 45-year old male was knocked over by a speeding car and then he was run over by five other vehicles. The accident occurred at about 5:00 p.m., i.e. at dark. It is not known how a dweller of one of the nearby villages found himself at a place where a string of motor vehicles moved with a high speed. At first, the pedestrian was hit by Audi Q7 and then next vehicles ran over him. His remains were scattered along a road stretch 200 m long [1].

On road No. 51 between Olsztyn and Olsztynek, an accident occurred on 23 Jan. 2014, in which one person was wounded. The accident happened at about 7:00 a.m., i.e. before

sunrise, near the village of Miodówko. According to preliminary reports, VW Passat hit the rear of a tractor-semitrailer unit, which was standing on the roadway due to a defect. In result of the accident, the car driver, aged 41 years, was severely injured [2].

On 24 July 2014, at about 11:00 p.m., an accident took place at Jadowniki in Małopolskie Voivodship. According to preliminary findings, a passenger car Fiat Panda first hit a group of wild boars crossing the road. In consequence, the car fishtailed onto the opposite lane and collided head-on with a motor truck. Three occupants traveling in the car, including a pregnant woman (i.e. 4 people in total), were killed on the spot [3].

On 18 Aug. 2014, at about 10:30 p.m., a woman was run over by two (or, may be, three) motorcars. Autopsy results have shown that the woman died because of being knocked down by a vehicle. According to witnesses' reports, a motorcar was previously standing at the place of the tragedy. One of the witnesses told about the car and a few people standing at it and looking nervous. It is quite likely that the driver of that car knocked down the woman or was one of those who had run over her. The injuries sustained by the victim have indicated that before being run over, she was walking and then she was knocked down by a vehicle. According to preliminary findings, the woman driving a Renault Laguna car along a road bend was dazzled by the lights of an oncoming motor vehicle and at that moment, she ran onto the person lying on the ground and her car bumper caught on the lying body. After a while, the driver of a Rover car following the Laguna, seeing the situation, tried to drive around the person lying on the ground but hit the lying body with the car bumper. The drivers stopped their cars at the accident site. Both of them were sober. The victim was dressed in dark denim trousers, dark-brown sweater, leather-like waistcoat (with textile front and back), and black shoes. The event took place close to a road crossing. A walkway and a cycle track ran along the carriageway, separated from it by a lawn [4].

In accidents of this type, which happened at dark, a key issue is the fact that the drivers did not notice the persons (or objects) early enough when the road was only illuminated by motor vehicle headlamps. Due to the prevailing traffic conditions, only the passing beam may be used in most cases; therefore, the range of road illumination by the passing beam is of critical importance. There are also other factors related to visual perception that have an impact on the issue under consideration, such as the manner and degree of light reflection (colour of pedestrian's clothes, the fact that the pedestrian has or has not retro-reflective markings or objects, the properties of such markings and objects and the way how they are worn, colour of animal's coat, animal size, etc.), state of driver's eyesight, and possibility of being dazzled or blinded by glaring light.

Moreover, it often happens that additional circumstances enhance the risk of such accidents, e.g. the presence of a pedestrian in a place where this could never be expected by the driver (e.g. on a fast traffic road), but this will not be covered herein.

3. Legal aspects

If an accident has already happened, a problem arises as regards the identification of the persons (or factors) that are accountable for such an event and the establishing of

the consequences, e.g. the punishing of those guilty, insurance issues, indemnities for victims, etc.

A few issues should be clarified at the reconstruction of accidents where the visibility in the light produced by vehicle headlamps is important. They include the following:

- vehicle speed;
- necessity of using appropriate "illuminating" lamps, i.e. driving-beam, passing-beam, and front fog lamps, according to the situation on the road;
- technical condition of the vehicle lighting system.

If all the above factors are appropriate for the situation then, at least theoretically, the accident should not occur, of course at an assumption made that no additional circumstances emerged that would enhance the accident risk, such as a pedestrian unexpectedly rushing onto the road just before the approaching vehicle, the driver falling asleep, or the like. If, however, the above three issues are more carefully examined then a relatively complicated situation may be noticed, where the vehicle stopping distance at the specific vehicle speed should be shorter than the distance from which the driver would be able to detect and identify the obstacle illuminated by the light produced by his/her vehicle in the specific conditions (this is related to the properties of both the vehicle lighting and the obstacle). In such a situation, it is difficult to formulate simple and unequivocal settlements.

It is worth being aware of the data according to which for a vehicle moving with a speed of 70 km/h, the vehicle stopping distance (inclusive of the distance travelled during the driver's reaction time) on an extra-urban road at night exceeds the sight distance.

The vehicle speed is always a very important factor because both the possibility of stopping the vehicle and the collision effects always depend on the speed. However, the criteria of maintaining the safe speed are much more complicated.

The driver is obliged to keep the vehicle speed within limits appropriate for the current traffic conditions [5]. In practice, he/she may be guided by the regulations that define the maximum speed permissible for the road of the specific category and by his/her judgment whether the current driving speed is appropriate for the actual visibility range and, in consequence, is safe. Usually, this is an effect of driver's personal experience because the knowledge of any unequivocal criteria that would help to determine a specific numerical value of the safe speed cannot be obtained at driver training courses. The only relevant numerical values specified in the laws and regulations [6] are the minimum distances to which the road shall be illuminated by the passing beam and driving beam at good air clarity (40 m and 100 m, respectively). In reality, the actual values of these distances vary within very wide limits, as it will be shown in the subsequent part of this paper, and they depend on many factors, which include the properties and current condition of the specific headlamps of the specific vehicle. If no specially reduced limits are imposed by the legislation on the vehicle speed at night as against those allowed in the daylight and, simultaneously, the vehicle headlamps (and brakes, too) are subject, according to the laws, to specific technical requirements and periodically checked for conformity with such requirements, then the driver may surmise that when driving with a permissible speed, he/

she would be able to see an obstacle early enough to stop the vehicle before hitting it. To verify the rightness of such a general approach, it is worthwhile analysing the issue of the illuminating performance of headlamps and the range of road illumination by them as well as the possibilities of noticing and recognizing road obstacles.

Obviously, the road is best illuminated by the driving beam, although the illumination is diversified depending on the vehicle and the headlamp construction. However, the possibility of using such headlamps is very limited because of traffic conditions, which very seldom are such that there are no eyes of other road users exposed to a risk of being dazzled, directly or indirectly (e.g. through rear vehicle mirrors), within the range of the headlamp light.

If solely the front fog lamps are used, it can be noticed that the visibility is improved as against that provided by the passing-beam headlamps only in the conditions of very dense fog. In such conditions, however, the vehicle speed must anyway be radically reduced, even to below 30 km/h, because nothing can be noticed by the driver from a longer distance. The practical effects of an accident that would occur at a speed like this would be relatively small, as well. In addition to this, the road illumination range in such conditions will be limited by the fog rather than by the lamp performance. Moreover, the situations with very dense fog, in which fog lamps might produce the optimum road illumination, are relatively rare in the Polish climate. Besides, the front fog lamps must be very precisely aimed to provide a noticeable improvement in road visibility in dense fog in comparison with that offered by the passing-beam headlamps.

The above shows that after dark, the passing beam is predominantly used by the vehicles participating in road traffic; therefore, our interest in the subsequent part of this paper will be chiefly focused on this vehicle lighting subsystem and a decision about the type of the lights that should be used in specific circumstances can in most cases be made without major doubts. If the driving beam is used inappropriately or unlawfully, dazzling can take place and, as a matter of principle, the dazzling can only affect other participants in the traffic. Hence, in the case that anybody inappropriately used the driving beam of his/her motor vehicle and this resulted in an undesirable traffic event then, in most cases, the perpetrator remains unidentified because of having moved away without noticing the event, as such an event usually takes place a little bit later and with participation of other road users. On the other hand, the inappropriate use of the driving beam is very hard to be proven by those who were dazzled in result of this. For the same reasons, it is very difficult to show that somebody was dazzled by e.g. a passing-beam headlamp that was inappropriately aimed or provided with a wrong light source.

The technical requirements set out for motor vehicle lights and the method of ensuring that the requirements will be complied with constitute an important legal issue. The structure of creation and implementation of legal requirements for headlighting has been outlined in Fig. 1.

In general, there are two levels of regulations:

- Type-approval requirements, which must be met by vehicle components and complete vehicles supplied by manufacturers;
- Operational requirements, which must be met by the lamps installed on a vehicle so

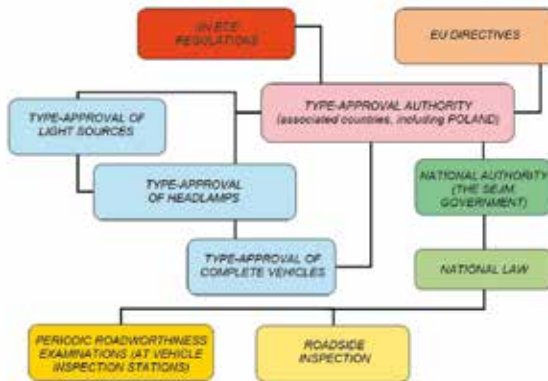

Fig. 1. Structure of the system of requirements for headlighting

that the vehicle is periodically granted a certificate of authorisation to be used in road traffic, in a procedure that would include examination at a vehicle inspection station.

Although being closely related to each other, these two systems define their requirements in different ways. The type-approval requirements that are in force in Poland and in the other European Union countries have been based on the system of type-approval regulations of the United Nations Economic Organization for Europe (UN ECE Regulations) [7]. In the field of headlighting, the requirements must be met at three construction levels: by light sources [8, 9, 10], by headlamps [11, 12, 13, 14], and by the installation of headlamps on the vehicle, together with the requirements for the initial headlamp aiming and levelling [15,16].

Originally, the type-approval requirements for headlamps (passing beam and driving beam) were defined depending on the light source used. UN ECE Regulation No. 1 provided requirements for headlamps with a classic double-filament low-voltage bulb, which was the only bulb type available in that period (1958). A decade or two later, requirements for headlamps with single-filament halogen bulbs were laid down in [18]; for headlamps with double-filament halogen bulbs, the requirements were set out in [19]. In 1990s, another solution was introduced in the form of headlamps with gas-discharge light sources (popularly referred to as "xenon lamps"), for which the requirements are specified in [12]. At that stage, as many as three solutions differing from each other in qualitative terms were permitted for being legally used in vehicles without any additional usage requirements (such as e.g. a maximum permissible speed of driving at night). In the first decade of the 21st century, next changes were introduced in response to technical development. The so-called "old" requirements laid down in UN ECE Regulations Nos. 1, 8, and 20 were integrated into [11], with defining two classes (A and B) of requirements, roughly corresponding to the old regulations for classic and halogen bulbs. Simultaneously, the Regulation [14] became effective, where requirements were laid down for symmetric passing-beam headlamps approved for use in motorcycles. Within the changes that followed, adaptive passing-beam (referred to as adaptive front-lighting systems, AFS [13]) and, in the most recent years, automatic and adaptive driving-beam headlamps (ADB) were accepted for use and

requirements for such systems were introduced [13]. The latter solution may be a kind of turning point in the road illumination concept, although the quality and precision of defining the applicable requirements as well as the possibility of verifying them arouse many doubts and further ambiguities may be expected to appear with development of the market of headlighting systems of this type.

The light sources, which were originally thought as replaceable elements, were separately covered in [8] (filament lamps), [9] (gas-discharge lamps), and [10] (replaceable LED light sources). Moreover, the construction of headlamp units with non-replaceable light sources is also possible.

The system of operational assurance of adequate headlighting (passing beam) quality may be summarized as aiming the headlamps with the use of a special optical instrument and visual checking of their cut-off line, which should be asymmetrical, i.e. should ascend on the right side. The shape of the cut-off line has been defined in the type-approval requirements; for the conditions of operational examination, no cut-off assessment criteria have been specified. The light beam properties are not examined, either, except for the single-point measurement of the luminous intensity of the driving beam. In consequence, the authorization of a vehicle to be used in road traffic cannot be refused if the vehicle headlamps can glow unless they show obvious defects noticeable to the naked eye, such as corroded reflector or heavily matted lens.

4. Development of headlamp construction

The construction of modern headlamps is very much diversified. As mentioned above, different light sources can be used and even the incandescent lamps alone may be divided into about fifteen categories suitable for headlamps, with the halogen light sources still being developed at that. The most popular H7 halogen bulbs predominate in the market and the double-filament H4 bulbs are ranked second. The manufacturers of gas-discharge lamps successively offer new lamp categories, too. Apart from "classic" lamps D2S and D2R (35 W/3 000 lm), light sources 25 W/2 000 lm and sources with a high-voltage converter have become available as well [9]. The introduction of gas-discharge sources with variable power capacity, to be used in bi-xenon headlamps of new generation, is also planned.

In historical terms, the present-day headlamp concept emerged before World War II but the first legal regulation of this issue in the European market appeared as late as in 1958, within the UN ECE system. The detailed and technically simple way of formulating the relevant requirements was adapted to the limited possibilities offered by the then technology as regards the headlamp manufacturing and testing methods. The incandescent lamps could emit a relatively weak luminous flux of about 500 lm. The reflectors were shaped as a paraboloid of revolution. The principle of operation of a headlamp with a reflector of this type has been presented in Fig. 2 and an example of a factory-made headlamp with such a reflector has been shown in Photo 1.

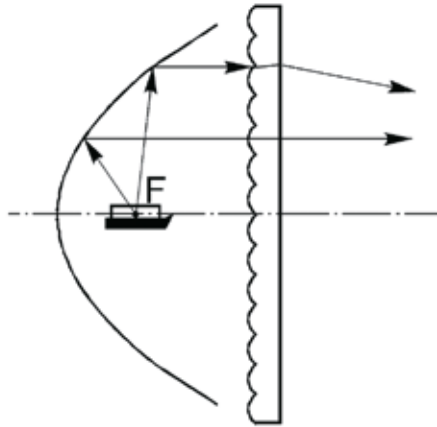

Fig. 2. Paraboloidal headlamp design. Bulb with a shield; only the passing-beam filament has been shown

A good point of the paraboloid headlamp design was the fact that the light emitted from the source (a short filament of a low-voltage incandescent lamp) was formed as an almost-parallel light beam even if the filament position slightly differed from that of the focal point. Moreover, the manufacturing of such a reflector was not difficult because the reflector was made by press-forming of a sheet-metal blank on a die, the shape of which was obtained by rotation of a segment of parabola. The drawpiece thus made was then metallized. The reflector calculations were also relatively simple, which was important in those days when relatively inexpensive and fast computers did not exist. The light beam was finally formed by a grooved (specially profiled) glass lens with prism-like elements that diffused the light.

Headlamps of this type, with characteristic round or truncated rectangular shape, which can be met even now, were for many years the only possible design and have fixed the popular image of the appearance and functioning of these vehicle parts (Photo 1).



Photo 1. Example of typical paraboloidal headlamp design

The headlight cut-off was obtained by shielding the bulb filament to cut off the lower part of the luminous flux. The bulb was also provided with another filament, unshielded, positioned exactly at the optical focal point to produce the driving beam.

The freedom of shaping the solid of light distribution was limited by the necessity of spreading a part of the luminous flux in the horizontal plane and directing a significant part of the flux to the place of the anticipated maximum luminous intensity (areas close to the type-approval test points 50R and 75R). The luminous flux of the bulb, subject to manufacturing and energy limitations, was additionally reduced by the shield applied to cut off the lower part of the luminous flux, which otherwise would be reflected by the lower reflector part towards the eyes of oncoming drivers (above the horizon).

Since the paraboloidal design was subject to many limitations and the luminous flux distribution could be considered predictable, an assumption was made that checks at several characteristic points and areas would be sufficient for ensuring the minimum required illuminance values in the entire area of interest. This radical simplification of the mathematical model of a lighting device, which on the other hand had to fulfil a relatively complex task, resulted in far-reaching consequences many years later. The simplification, however, was additionally justified by the capabilities of the measuring equipment available at that time. The photo-element (e.g. a selenium cell) had to be relatively large (with a diameter of about 60 mm) for adequate sensitivity and correction of spectral-response characteristic to be obtained. It was moved manually against the background of the "measuring" screen, which was situated at a distance of 25 m from the headlamp tested and was illuminated by the light beam emitted by the headlamp.

The solution adopted had an important good point: a single all-purpose headlamp with a double-filament bulb produced two types of light (passing beam and driving beam). Thus, the division of headlights into driving beam and passing beam has become a generally observed rule based on the idea to limit the emission of light within the zone where the eyes of other participants in the road traffic could be present and be thus exposed to a risk of being dazzled. From the present point of view, it is clear that such a solution is not perfect. Therefore, it has found now a successor representing a different headlighting concept, i.e. adaptive passing-beam (AFS) and, in the most recent years, automatic and adaptive driving-beam headlamps (ADB), the principle of which is to illuminate the entire space ahead of the vehicle except for the places where an automatic sensor (a camera with appropriate software) detects (indirectly) the presence of eyes exposed to a risk of being dazzled.

Originally, the photometric requirements for the passing-beam headlights were formulated for testing the lights with the use of a screen perpendicular to the optical axis of the headlamp in idealized conditions, i.e. for a single headlamp mounted at a height of 75 cm, with the cut-off plane (defined by the horizontal part of the cut-off line) being inclined downwards by 1%; the lines on the screen correspond to a straight road section ahead of the vehicle (Fig. 3).

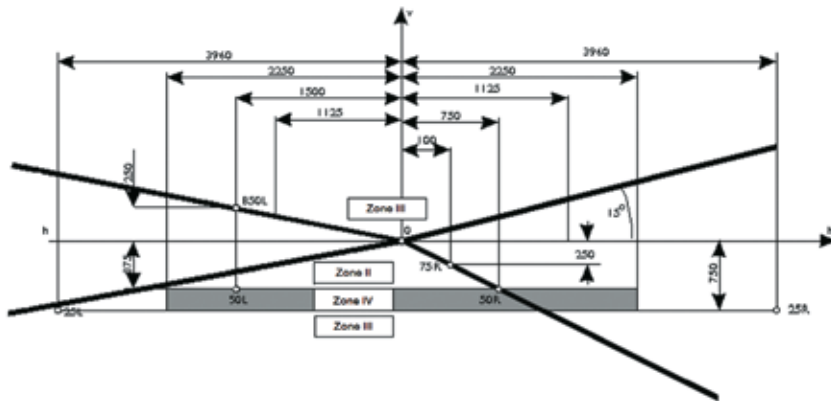

Fig. 3. Arrangement of characteristic points and zones on the measuring screen for passing beam tests

The photometric requirements were specified for several points on the screen and, comprehensively, for selected screen zones. The fulfilment of these relatively uncomplicated requirements gave reasonable grounds for anticipating the road illumination to be as expected because the distribution of luminous intensity could not vary too much and was predictable. If the minimum requirements concerning the illuminated places were successfully met then rather a small part of the total luminous flux available remained to be utilized. An important drawback of the paraboloidal design was the fact that a relatively large quantity of light was directed to zone I, where it was not needed, rather than to the zones closer to the horizon for the more distant road parts to be better illuminated.

Subsequently, the paraboloidal reflector design was improved by introducing a "double-paraboloidal" solution (Photo 2), which became a precursor of the FF ("Free Form") design.



Photo 2. Double-paraboloidal headlamp

It was quite clear that a rule was originally adopted to provide the headlamps with replaceable bulbs, which burnt out after a relatively short period of being in use (several hundred hours). The bulb replaceability requirement entailed the necessity that the headlamps had to be kept in conformity with the required repeatability of headlamp characteristics and this, in consideration of the high precision required at shaping the light beam, forced high repeatability of bulb characteristics and precise positioning of the bulbs in the headlamps. Therefore, the geometrical bulb characteristics, i.e. filament dimensions and its position in relation to the bulb locating elements, were precisely defined [8]. For the bulbs used as reference standards (etalons) at type-approval testing of headlamps, very stringent requirements were laid down. For the bulbs to be used for normal production purposes, however, the tolerances allowed were several times wider than those adopted for the reference standards (etalons).

This idea of "double" tolerances was proposed as one more concept of requirements related to the "construction" of headlamps. The formulation of requirements and the technical specifications laid down in standards for headlamps and bulbs were adapted for a specific engineering solution. This means that a principle was adopted to relate the requirements to the "construction" of a product. However, a principle of relating the requirements to the "properties" of a product would be more desirable from the road traffic safety point of view, because in the case of modifications to the existing designs or introduction of new engineering solutions, such an approach would not lead to a paradox that new engineering solutions meeting the "old" requirements might have markedly worse or even unpredictable properties.

However, the effects of this kind were not originally expected and the production of bulbs and headlamps is still possible without violating the existing legal regulations concerning this issue. Admittedly, it would be difficult to keep the mass-produced bulbs in conformity with the requirements applicable to etalons or to manufacture headlamps that, when provided with mass-produced bulbs, would meet the type-approval requirements. In practice, the light beam deviations in mass-produced headlamps were, roughly, predictable and not very big thanks to large dimensions of paraboloidal reflectors. Light beam deviations were compensated by aiming the headlamps as a whole, which made a basis for the "headlamp aiming" routine maintenance ("operational") procedures. This, however, did not fully restore the conditions of type-approval examination. With the headlamp dimensions being reduced and new "non-paraboloidal" designs being introduced, the problem of geometrical tolerances of bulbs may increasingly affect the quality and properties of the light beam in the operational conditions and may significantly impair the illumination characteristics of a headlamp. Since this is not checked in any way, the headlight users often remain unaware of such a problem.

Misleading is the fact that the system of type-approval photometric requirements based on headlight examinations carried out with the use of a vertical screen seems to offer objective information about the headlamp properties, because such a system is not directly related in any way to the headlamp construction. However, there are hidden relationships of this kind in the form of choosing the system of coordinates (vertical screen), small number of measuring points, and relatively large illumination zones which, when transformed to the road surface, do not adequately represent the actual illumination

of the objects present on the road. Such a method of defining these issues has still been arousing much misunderstanding among people, inclusive of experts, the more so that, due to the long time (over 50 years) of the type-approval system having been in use, many experts were "raised" on it and consider it as natural, without pondering over the questions how the said system of type-approval photometric requirements was created, what needs it originally was to meet, and what is the mathematical model that it represents.

Until now, the construction of motor vehicle headlamps went through extensive evolution resulting from technological progress. This includes the introduction of new, more efficient light sources and new methods of designing and manufacturing the light beam shaping elements, which enabled even many-fold growth in the efficiency of utilization of the luminous flux emitted by the light source. This process is in progress and further development may be expected in the future.

The first step in these changes was the use of halogen bulbs for headlighting purposes. Thanks to much larger luminous flux at similar power capacity, smaller dimensions, and increased durability, the halogen bulb was a much better light source suitable for motor vehicle headlamps. Originally, it was applied in the form of a double-filament bulb H4 to the tested and proven paraboloidal headlamp design. The road illumination noticeably improved. However, a problem emerged as well in the form of more intensive dazzle. With time, the growth in dazzle met with gradually increasing acceptance and, paradoxically, reduced the common reaction to it: at present, the reciprocal signalling of dazzle in road conditions is several times less frequent than it was in the past and the dazzle meets with higher tolerance. The halogen bulbs became commonly used and now they are the most popular light source, having many unquestionable good points at low price.

UN ECE Regulation No. 1 [17, 11], applicable to "traditional" bulbs with less stringent requirements, was kept in force as a parallel option. This was the beginning of formal consent for the use of two headlamp classes of different quality, which could be installed in vehicles on equal terms in the light of the laws in force.

Along with technological progress, successive engineering designs of single-filament halogen bulbs and headlamps were developed during the next years. The efficiency of light utilization was improved by introducing new "ellipsoidal" headlamps consisting of a reflector shaped as an ellipsoid of revolution and a converging lens functioning similarly to the image projector (Fig. 4, Photo 3).

In this case, the cut-off is obtained by means of a metal shield situated close to the optical focal point. A design solution like this requires the use of a single light source (single-filament incandescent lamp, gas-discharge lamp). Originally, it was intended for the passing-beam but with time, xenon lamps thus designed were provided with a movable shield for a "composite" passing-beam and driving-beam headlamp (referred to as "bi-xenon headlamp") to be obtained. In the next years, the FF ("Free Form") headlamp design (Fig. 5) was launched.

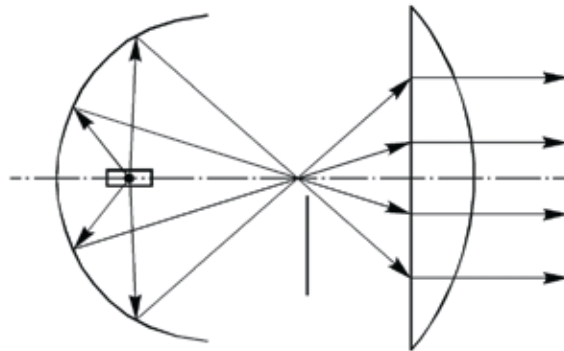

Fig. 4. The principle of optical design of ellipsoidal headlamp



Photo 3. Example of ellipsoidal headlamp

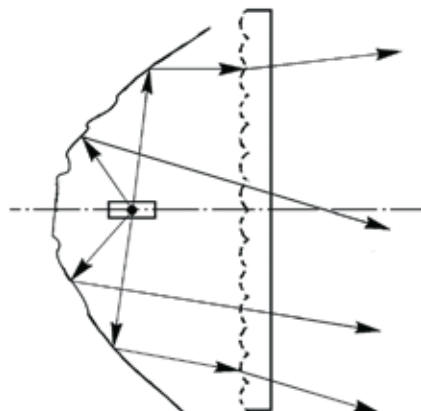

Fig. 5. The principle of optical design of FF ("Free Form") headlamp

Thanks to development of the technology of computer-aided calculation and modelling of reflector surfaces as well as ongoing increase in the computing power available, the FF design, which enables totally free shaping of the light beam, could be developed, where this freedom can only be limited by the injection mould making methods, headlamp dimensions, and designer's ingenuity. In this design, with a single-filament bulb being used, both the upper and lower reflector parts can direct the light onto the road below the horizon, which would bring about far more efficient utilization of the luminous flux emitted by the light source. In consequence, it has become possible to obtain definitely stronger illumination of the distant areas ahead of the vehicle and to spread the light beam more to the right and left from the vehicle symmetry plane and thus to improve the illumination of road shoulders and bends. This solution is also used with traditional double-filament bulbs (H4), thanks to which the light distribution is better than it is in the case of headlamps with paraboloidal reflectors.

An important feature of the FF design is the fact that there are no general rules of defining the reflector surface. The reflector surface is so shaped that the final distribution of the light beam can be as planned by the designer. Therefore, both the appearance of a headlamp of this type and its lighting characteristics may significantly differ from each other for individual design solutions. The designs with both plane-parallel (clear) and grooved lenses are possible, although the latter are less popular. Examples of headlamps made to the FF technology have been shown in Photos 4 and 5.

The FF technology has also appeared in the ellipsoidal headlamp design, where the reflector surface is no longer a pure ellipsoid and the lens may be aspheric or be given special irregular forms, especially in combination with LED lamps.

In spite of the development of headlamp and halogen bulb design, the type-approval requirements have remained unchanged. This means that the modern passing-beam



Photo 4. Example of FF headlamp with a double-filament bulb. "Faceted" style



Photo 5. Example of FF headlamp with a single-filament bulb. "Smooth" (continuous-surface) style

headlamps have incomparably greater road illumination potential than that of their predecessors but the designers of present-day headlamps are not obliged by the regulations to optimize the headlamp performance. Therefore, the utilization of this potential is neither required nor checked. In the situation of strong influence of fashions and designers on vehicle appearance and, on the other hand, the cost-cutting policy, headlamps with very similar appearance but with definitely different performance characteristics can be found in the market. This is very often the case when alternative headlamps are used to replace the original vehicle parts. A possibility also exists that headlamps markedly differing from each other in the appearance and manufacturing methods used may have similar properties. The only verifiable criterion, apart from the internal standards observed by some manufacturers of genuine vehicle components, is the conformity with the minimum type-approval requirements.

The ellipsoidal design with its variants made it possible to reduce significantly headlamp dimensions and to obtain very distinct and regular cut-off, which became an important argument for such a solution, with the cut-off definition being very imprecise. On the other hand, this design, especially in its simplest versions, has important drawbacks. Due to chromatic aberration of the single-lens projection system, the light emitted by such headlamps may be coloured, e.g. blue, red, or orange, in the areas close to the cut-off line while such colours are reserved for other specifically defined signalling purposes. Since the provisions of the regulations were formulated to be compatible with the paraboloidal headlamp design, the method of checking the light colour was based on the integration of the luminous flux; therefore, it does not make it possible to diagnose this problem.

A similar problem is related to the dazzling effect. To evaluate the dazzle, the illuminance has been adopted as a criterion, according to the requirements being in force. However, the degree of dazzling is determined not only by the illuminance at driver's eye but also by the contrast of the lamp surface being seen; the contrast is connected with both the lamp dimensions and its luminance. When the type-approval requirements were being prepared,

the paraboloidal headlamp design was characterized by a relatively big area of the lens, which was covered by light-diffusing elements, and an almost parallel light beam emitted from the headlamp lens surface. Thus, the luminance of the headlamp surface observed was relatively low and uniform and it was a simple function of the illuminance. In the case of the ellipsoidal design, where the aperture diameter is of the order of 5 cm, as against about 20 cm for the original paraboloidal design, the luminance value is up to ten times or even more as high. In addition to that, the "sharp" cut-off causes a nagging effect of flickering, often coloured, when the vehicle is moving on a bumpy road or in an undulating area. For the FF headlamps, the luminance effects are unpredictable and depend on the dimensions and shape of the light reflecting surface (cf. Photo 4 and Photo 5).

The appearance of the next and even more efficient light source, i.e. a gas-discharge xenon lamp, at the beginning of 1990s caused the type-approval requirements to be revised again, as it happened when the halogen bulbs were introduced. To reduce the dazzling effect, automatic headlamp levelling and washing systems were additionally introduced as obligatory vehicle equipment. The xenon lamps are superior to the halogen light sources because of even larger luminous flux offered (3 000 lm as against 1 000 – 1 500 lm for the halogen bulbs). The criteria of type-approval evaluation of the new product [12] were prepared according to principles being very close to those already existing. In particular, the road illumination range was not radically increased because the cut-off levelling conditions remained unchanged. Only the number of the measuring points was increased and the required values of photometric characteristics were raised. On the other hand, a widening of the illuminated part of the road situated at shorter distances in front of the vehicle became possible, which improved driver's eyesight comfort. Such a solution was accepted by the market in spite of its relatively high price, but it was chiefly applicable to motor vehicles of higher standard.

As the next headlamp development steps, adaptive passing-beam headlamps (AFS) and, subsequently, automatic/adaptive driving-beam (ADB) headlamps, whose essence is to adapt the light beam to current traffic conditions, were introduced at the turn of the first and second decade of the 21st century [13]. Since the light beam emitted by the adaptive headlamps should be automatically adapted to the changing conditions of vehicle movement, specific headlamp classes and operation modes were defined, including a "bending" mode.

Many elements of the new system were defined in [13], but the design basis of the photometric requirements for the passing-beam headlights remained unchanged in relation to the preceding regulations.

In the field of light sources, LED lamps were introduced as an up-to-date solution. Such lamps emit white light and the white colour of the light is obtained by exciting the luminophore to glow by means of a semiconductor source of blue or ultraviolet monochromatic light. The most recent solutions of this type are those referred to as "laser" light sources, whose principle of operation is identical as that of white LEDs, differing from the latter in the fact that the emitter of the light that excites the luminophore is a semiconductor laser and may be physically distant from the white light luminophore, which facilitates the heat removal and makes it possible to increase emitter's luminance with simultaneous reduction in its dimensions.

The basic designs of the LED headlamps are similar to those where incandescent lamps are used, i.e. they are based on the FF and quasi-ellipsoidal reflector solutions. However, other designs are also possible, e.g. multiple systems of small "spotlights" arranged in various configurations. Since the LEDs emit light in a hemisphere, unlike the incandescent and gas-discharge lamps emitting light all around, the use of simpler optical systems with smaller dimensions became possible, e.g. reflectors operating at an angle of 90° from the LED centreline and single plastic spherical and aspheric lenses or complicated optical systems, making use of the light reflection and refraction phenomena and made of one piece of appropriately shaped transparent plastic, with a possibility of using fibre-optic elements as well. In the case of LED light sources, it is possible to build multiple small-size repeatable systems as well as projection systems using LED matrixes or combinations of both, to fulfil the adaptation functions. Thanks to all the above, extremely wide diversity of shapes and systems of such headlamps is possible, which enables the achieving of unique and diversified vehicle appearance. At present, this is more the question of designers' imagination and ideas than the problem of technological possibilities or headlamp properties, which have not been connected anymore with headlamp construction or light source issues for a long time.

The LED technology has provided designers with an inexhaustible source of inspirations and a tool for free shaping of vehicle appearance. On the other hand, the photometric requirements, quite simply formulated and specified in low figures, have still been left unchanged and this results in the fact that many of the LED headlamp designs offered, looking very "modern", have performance characteristics much worse than those of inexpensive designs with halogen lamps because of cost, space, and energy saving considerations and problems with heat removal from semiconductor elements.

A separate problem is the ageing of present-day headlamps. While halogen bulbs glow in a quite constant way until burnout, the gas-discharge and LED lamps gradually lose their efficiency in a way unnoticeable for the user and the instant when they should be renewed may be easily overlooked or ignored, especially in the light of manufacturers' advertisements where the service life of such lamps is claimed to be longer than that of the whole vehicle.

5. Diversified headlighting properties

In result of development in the field of technologies and standard requirements, there are now four basic groups of criteria applicable to the lights that fulfil the same task in road traffic, i.e. to the passing-beam headlights of different types [11, 12, 14] and to two new categories of adaptive headlights [13]. Within each group, headlamps with significantly diversified luminous intensity distribution can be designed. Reputable companies dealing in the designing and production of automotive lighting devices offer headlamp models having good properties from the road illumination point of view, although this high quality is often understood subjectively. At the evaluation of headlight quality, a question should be first answered whether the light beam should illuminate the road over a longer distance or it should be wider. This translates into a pair of relatively simple but opposing criteria, i.e. road illumination range and light beam width.

Simultaneously, less expensive vehicles or vehicles with refined fashionable body shapes may be provided with headlamps whose characteristics would be just sufficient to meet the type-approval requirements. A similar problem is encountered in the case of alternative (substitute) headlamps supplied by competing manufacturers. In consequence, vehicles frequently participate in road traffic whose headlamps, although designed for the same purpose and even looking very similar to each other, may illuminate the road in a considerably different way. A key issue in this case is the fact that the appearance, light source used, or design features cannot be considered decisive for the quality or characteristics of a specific headlamp, as every technology available makes it possible to obtain high headlamp efficiency and to make subjective decisions about choosing the zones to be illuminated and defining the illuminance to be achieved in the zones chosen.

It should be noticed that in result of the above, the driver of a vehicle provided with the "weakest" headlights, simultaneously causing the least glare, can see the least and, simultaneously, may be much more intensively dazzled by the oncoming headlights of higher generations. There are no restrictions regarding the use of headlights of different types, e.g. even such as the simplest one, according to which the permissible vehicle speed should be correlated with the performance (type-approval generation) of the headlamps of the vehicle involved.

The characteristics of the light emitted by vehicle headlamps in normal operation conditions also depend on the quality of replacement filament and gas-discharge (xenon) light sources. This problem may soon affect the replaceable LED light sources, although the scatter between characteristics of individual specimen headlamps of the same type provided with non-replaceable LEDs may also be significant. The standardization of light sources as mentioned above [8, 9, 10] and the division of light sources into etalons and mass-produced lamps has survived in spite of the revolution in the headlamp manufacturing technologies. While the influence of tolerances of mass-produced bulbs in the early headlamp designs was, to some extent, predictable and it could be partly compensated by aiming the headlamps, this impact is not controlled in the present-day headlamps of very sophisticated construction. It depends on the susceptibility of a specific design to the tolerances of geometrical position and to the shape of the light emitter, e.g. the filament of an incandescent lamp.

The ellipsoidal designs, as a rule, have small reflectors; therefore, they may be very sensitive to deviations of the filament position. Moreover, the cut-off is shaped by a shield placed in the way of the light beam. In consequence, any geometrical deviations of the filament position may result in significant deviations of the point corresponding to the maximum luminous intensity from the zero point of the coordinate system defined by the cut-off position and, as well, in a considerable reduction in the illuminance value. Examples have been shown in Figs. 6, 7, and 8.

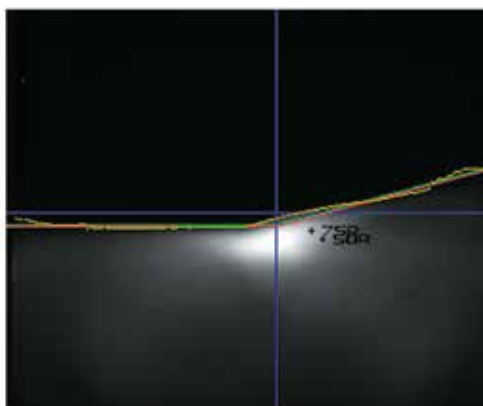

Fig. 6. Visualization of the cut-off line and the beam pattern produced by an ellipsoidal headlamp with an etalon bulb. The maximum luminous intensity point is close to points 75R and 50R

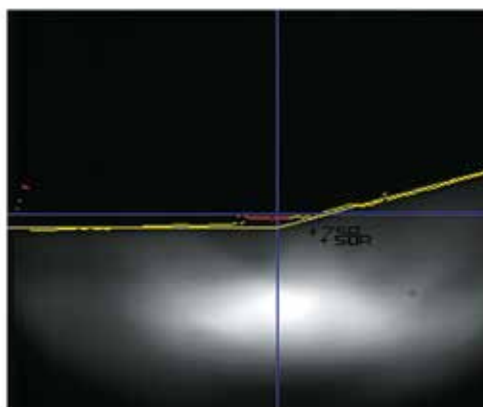

Fig. 7. Visualization of the cut-off line and the beam pattern produced by the headlamp of Fig. 6 with a random mass-produced bulb

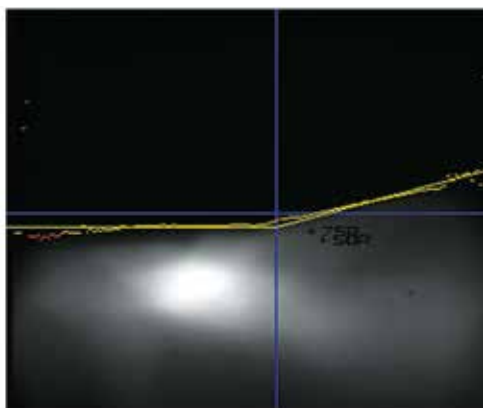

Fig. 8. Visualization of the cut-off line and the beam pattern produced by the headlamp of Fig. 6 with a random mass-produced bulb different from that of Fig. 7

For the FF headlamp design, the impact of deviation of the filament position on the luminous intensity distribution is definitely more difficult to be predicted: it depends on a specific reflector shape and the deviations often result in deformations of the cut-off, making thus the correct headlamp aiming very difficult. A similar situation takes place in the case of LED headlamps. In the designs where the headlamps are relatively big, the LED light source is usually quite small in comparison with the reflector and, in consequence, better repeatability of the beam distribution can be achieved. If, however, the headlamp is built as a system with multiple miniature reflectors or lenses, then this impact may be noticeable or even significant.

It is worth noticing that for the minimum type-approval requirements to be met, it would be sufficient to emit a luminous flux of below 200 lm to the sectors defined in the relevant type-approval regulation. A halogen lamp can emit a luminous flux of 1 000 lm to 1 500 lm. This means that the light-emitting efficiency of a headlamp does not have to be too high and even if it is high then the luminous flux produced does not have to be optimally utilized.

Due to unavailability of other, better tools and methods of comparison, schematic comparisons are made, especially with regard to the light source or headlamp construction. As an example, the characteristics of a headlamp with an H4 filament lamp, even if optimally designed and made, will be inferior to those of a headlamp with an H7 bulb in respect of the headlamp construction and luminous flux. This, however, does not mean that every headlamp with an H7 bulb will be better than every headlamp with an H4 bulb, although the probability of such a statement being true in individual cases is quite high. Nevertheless, it is commonly held that a headlamp with an H4 bulb would always be worse. Interestingly, H4 bulbs are used, for stylistic reasons, in numerous more expensive vehicle models.

Fig. 9 shows isolux diagrams of the vertical illuminance at the road surface for four different brand-new headlamps that were type-approved and aimed according to nominal specifications.

In the diagrams presented, considerable differences can be seen between the isolux plots in respect of both the longitudinal range and width of the light beam. According to the present-day headlamp evaluation system, however, the headlamps in question will be considered, in terms of their quality, to be equivalent to each other as having been type-approved. Actually, as it can be easily noticed, the properties of these headlamps significantly differ from each other, especially as regards the range and width of individual isolux contours. On the other hand, it is interesting that practically all the headlamps show a similar road illumination range in the plane shifted a little to the left from the vehicle symmetry plane: for the 1 lx and 3 lx isoluxes, it varies from about 55 m to 80 m and from 45 m to 65 m, respectively. This is because of the presence of a horizontal part in the cut-off line and specific requirements laid down in the type-approval regulations to limit the dazzling effect. The differences arise from differences in the headlamp mounting height. Additionally, they will be affected in vehicle operation conditions by the headlamp aiming and levelling due to e.g. changes in the vehicle load.

In practice, there is a need to make assessments and comparisons of vehicle headlighting both at the stage of product selection by a purchaser and for technical purposes, including

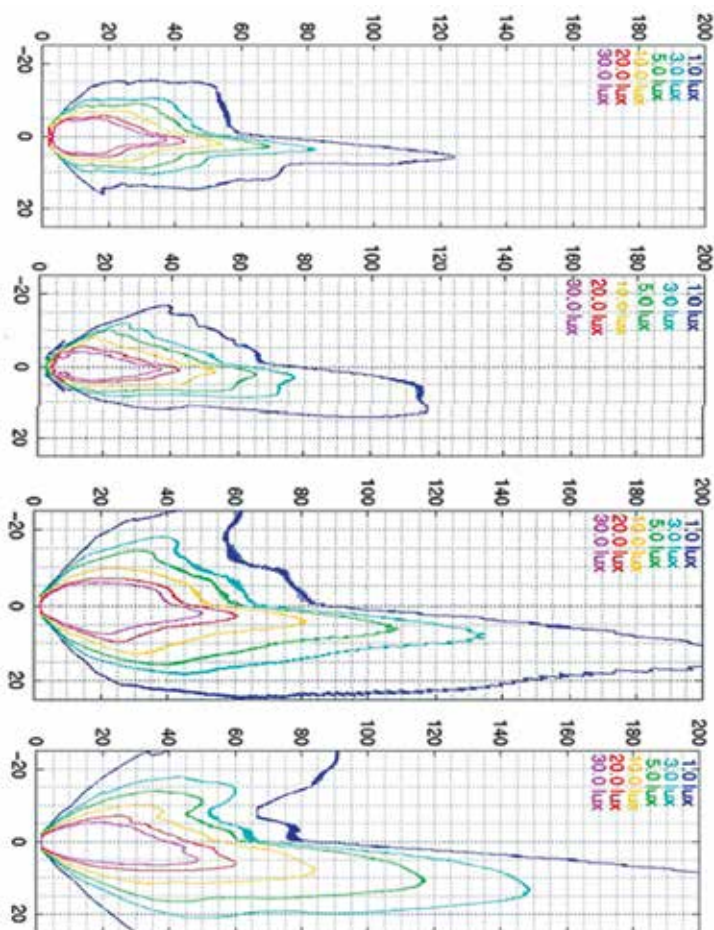

Fig. 9. Examples of isolux diagrams for the road surface ahead of the vehicle for four different type-approved headlamp sets (distances in [m] from the vehicle front and from the longitudinal vehicle symmetry plane). Headlamps aimed according to nominal specifications. (Source: CIE TC4-45)

accident reconstruction. For the road illumination, especially the road illumination range, to be reliably evaluated, much information is required. Detailed characteristics of the light beam are the basic data. They may be obtained from a photo-goniometric examination carried out at a type-approval laboratory or a lighting manufacturer's laboratory. Such an examination requires the headlamp under tests to be removed from the vehicle, it is relatively time-consuming and expensive, and it will only return characteristics of the specific specimen headlamp-bulb unit. In the case of a post-accident examination of a headlamp, such a method is hardly practicable, firstly because of its cost and secondly because the headlamp is most often damaged or destroyed. An additional important factor that affects the road illumination range is the actual aiming of the headlamp when installed on the vehicle and this may be difficult for verification.

An alternative to the laboratory photo-goniometric examination is the use of a "headlamp analyser" [20] (Photo 6), which offers a possibility of both very quick measurement (within less than 1 minute) of light beam characteristics and very precise measurement of the aiming of a headlamp of any type.



Photo 6. View of a "headlamp analyser"

The measurement is carried out on a vehicle, without a need to remove the headlamp, and the measurement cost is very low.

6. Road illumination range

The "road illumination range" is a notion of quite a general nature. Intuitively, it may be defined as the distance along a straight road section within which the driver should be able to see, in the headlamp lights, any objects that would be important for traffic safety, such as pedestrians, cyclists, animals, holes in the road surface, etc.

The evaluation of the visibility range in the situation when a road is illuminated by vehicle headlamps is a complex issue. For an object to be noticed and then recognized, it must have at least a minimum brightness (luminance) and adequate contrast in relation to the background, exceeding the contrast threshold. For objects present in night-time conditions on the road far ahead from a vehicle, an assumption may be made with good approximation that the background is black, although it may have some luminance due to stray light from vehicle headlamps, remote street lamps, the sky, etc.

It can be easily noticed that the visibility of an object is determined by the coefficient of light reflection and the object illuminance caused by the light falling on the object and affecting the luminance (brightness) of the object and, possibly, its contrast in relation to the environment (which in night-time conditions is usually dark). As another important issue, we should mention the angular dimensions of the object as seen by the driver, which depend on the geometrical dimensions and distance between the object and the driver. Since the illuminance, like the angular dimensions, decrease with squared distance, this has an additional impact on the conditions of evaluation of road illumination. A factor that cannot be ignored is the horizontal distribution of luminous intensity of the headlight beam. The road is seldom ideally straight; usually, it has bends and turns. Hence, an object being straight ahead will be perceived differently from an identical object situated on the right or left road bend, depending on individual differences in the distribution of luminous intensity. The dynamic characteristics of the adaptive systems will also have a considerable impact on the range of road illumination by such headlamps.

The objects that can appear on the road have diversified and not fully predictable dimensions and coefficient of light reflection. Pedestrians may wear both bright and black clothes. Therefore, the mathematical modelling, although possible, is quite complicated and cannot give unequivocal results. Therefore, simpler empirical models are adopted. The object luminance value is affected by the coefficient of light reflection and the illuminating characteristics of the headlight beam, i.e. the vertical illuminance. It has become commonly accepted to use the values of a predefined isolux representing the threshold illuminance that would make it possible just to notice the object modelled. Usually this is a sufficient approximation, especially if the method of defining the type-approval requirements for automotive headlamps is concerned [19]. The threshold illuminance values have been adopted by convention as 1 lx and 3 lx [19]. In the case of the passing-beam headlamps with a distinct cut-off line, a steep vertical gradient occurs in the illuminance close to such a line and the required illuminance values are defined in the applicable type-approval regulations [11, 12, 13, 14]. Thus, the illuminance values in the zone above the cut-off, when measured at the road surface, will rapidly drop at a distance of not more than 100 m and will certainly not exceed 1 lx; below the cut-off, they will be higher and rapidly growing towards the bottom of the beam (in vertical cross-section), i.e. with decreasing distance from the vehicle (cf. Fig. 9). Therefore, a simplifying assumption has been made that for the road areas closer than the intersection of the cut-off with the road surface, the road illumination will be sufficient for an obstacle to be made visible.

According to UN ECE Regulation No. 48 [15], the passing-beam inclination may vary with the vehicle load and it should be kept within the ranges as defined in Fig. 10.

The cut-off range as measured at the road surface, calculated from the acceptable cut-off inclination values for the acceptable headlamp mounting height values, is as shown in Fig. 11.

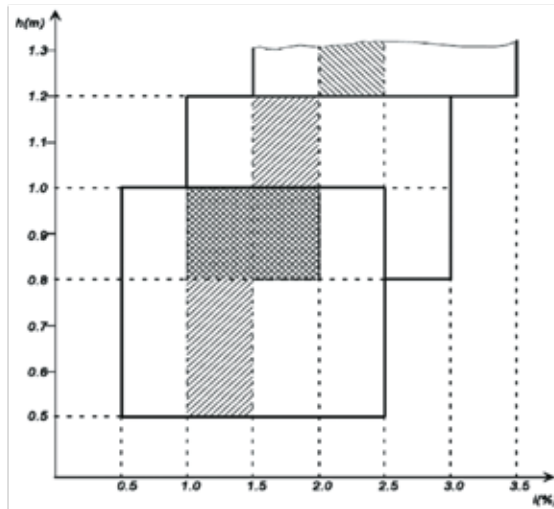

Fig. 10. Initial aiming of the passing beam (hatched area) and levelling tolerances at varying vehicle load conditions: "h" - headlamp mounting height; "i" - vertical inclination of the cut-off (inclination of the cut-off plane, defined by the horizontal part of the cut-off line) [15]

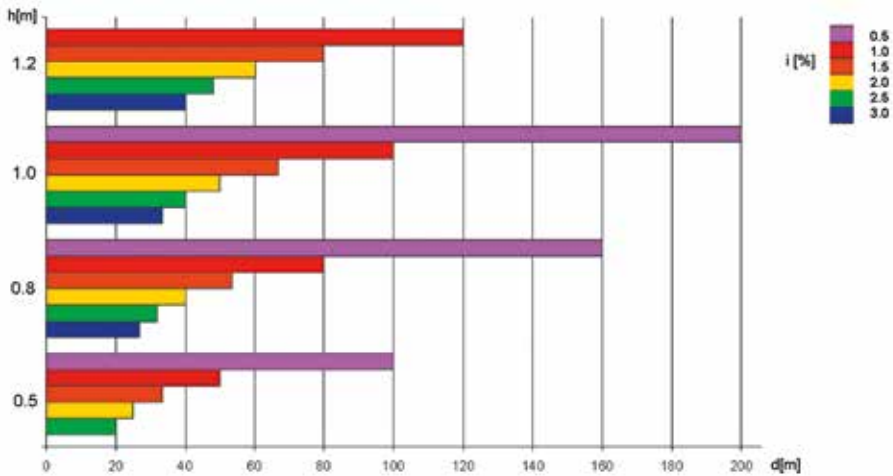

Fig. 11. Road illumination ranges: "h" - headlamp mounting height; "i" - vertical inclination of the cut-off (inclination of the cut-off plane, defined by the horizontal part of the cut-off line); "d" - distance to the intersection of the cut-off plane with the road surface

It can be easily noticed that the minimum values of the road illumination range determined in accordance with the above definition, which follows logically from the type-approval requirements, may be even as low as about 20 m, especially for low-mounted headlamps of passenger cars, as against the maximum values reaching 200 m. For real headlamps, however, an impact of the inverse square law can be observed, according to which a luminance of the order of even 20–40 lx measured at a distance of 25 m is reduced to about 0.5 lx for a distance of 200 m. In practice, such a very long range of road illumination can only be achieved for headlights with very high luminous intensity just below the cut-off. Nevertheless, the simplification adopted previously to estimate the minimum road illumination range remains useful.

The above situation takes place in the case of nominal type-approval conditions, i.e. for a new vehicle with its headlamps having been "ideally" aimed. In the normal vehicle operation conditions, additional impact is exerted by factors related to inaccuracy of headlamp testing equipment, deviations of characteristics of mass-produced headlamps and bulbs, lamp ageing, etc. The passing-beam headlamp aiming tolerances are, in the vertical direction, $\pm 0.3\%$ upwards and $\pm 0.5\%$ downwards, according to the requirements applicable to periodic inspections. The accuracy of headlamp testers is about $\pm 0.3\%$, according to manufacturers' data (apart from the measuring stand levelling accuracy), and this seems to be an optimistic estimate (for the "Headlamp analyser", the accuracy is better than $\pm 0.1\%$). In consequence, the passing beam produced by a headlamp having been properly aimed may be inclined downwards by more than 0.8 percentage points in comparison with the value declared by the manufacturer and meeting the type-approval requirements. For the nominal inclination value of -1.0% , this means that the road illumination range may be thus shortened to about 56 % of its nominal value.

Examples of actual road illumination characteristics for three selected headlamps have been visualized below. The lighting characteristics of real headlamps are very much diversified, but the examples shown below, having been arbitrarily chosen, represent some "extreme" model situations. The performance characteristics of the first headlamp are close to the minimum required (although somewhat better than the minimum in the horizontal direction as measured in the zone situated to the right from the vehicle symmetry plane). The second illustration shows a special case, with an LED headlamp which, although producing a relatively large luminous flux, has not been optimally built, as the point corresponding to its maximum luminous intensity is shifted much below the cut-off and the asymmetry on the right side is insignificant, in result of which the illumination range on the right side is only slightly increased. The characteristics of the third headlamp may be considered very good as against the possibilities offered by the present-day technologies. The luminous intensity distributions determined for a vertical screen situated at a distance of 25 m have been shown in Figs. 12, 13, and 14, respectively. They were obtained with the use of a "Headlamp analyser".

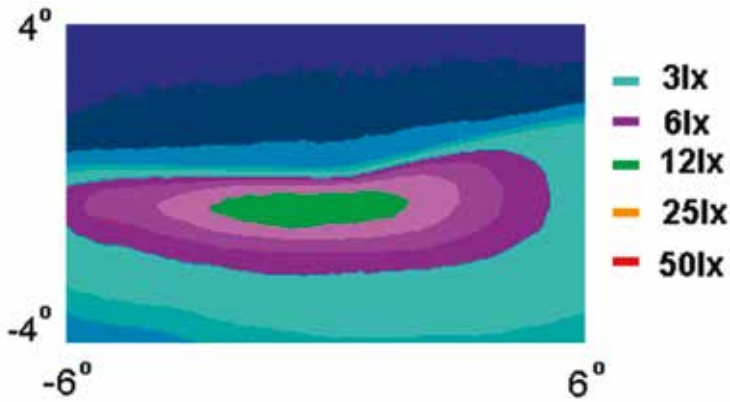

Fig. 12. Illuminance distribution determined on a vertical screen for headlamp No.1

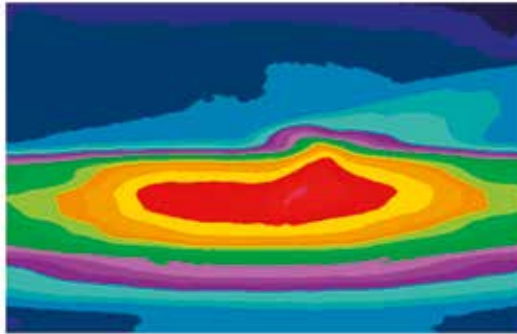

Fig. 13. Illuminance distribution determined on a vertical screen for headlamp No. 2

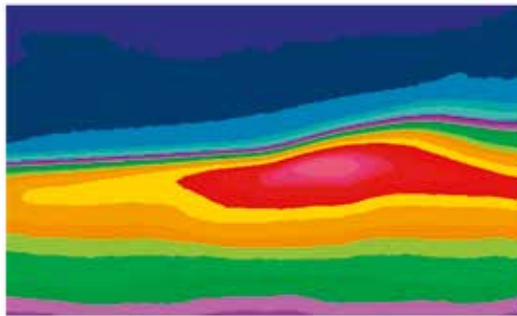

Fig. 14. Illuminance distribution determined on a vertical screen for headlamp No. 3

Fig. 15 shows the road illumination range for the above headlamps in the form of isolux diagrams of the vertical illuminance at the road surface for the optimum road illumination conditions, i.e. for a headlamp mounting height of 100 cm and a beam inclination of -1.0% .

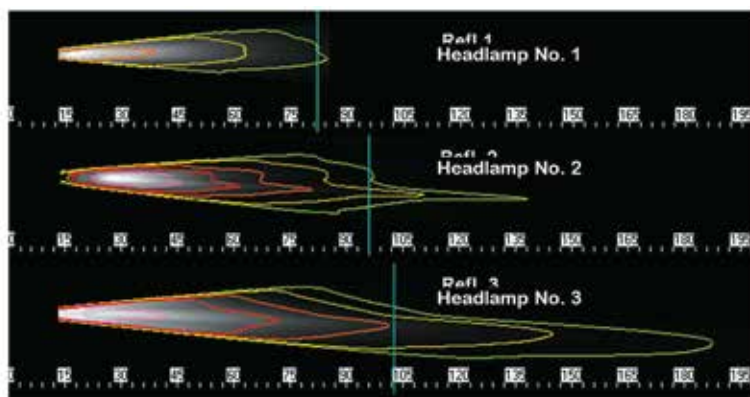

Fig. 15. Distribution of vertical illuminance at the road surface. Isolux contours from 1 lx (green) up

In the figure, the road illumination range values have been marked for the 1 lx isolux contour (green) on the left side from the vehicle symmetry plane. These values are close to each other and fall within limits from 80 m to 100 m. For the next isolux contour, this span is somewhat wider. The illumination range values on the right side are much more diversified. For headlamp No. 1, this range is practically equal to that for the left side, while it is almost doubled in the case of headlamp No. 3. The light beam widths, as it can be easily noticed, are significantly diversified, too.

Effects arousing much more interest were obtained when the most unfavourable conditions, allowed by the type-approval requirements, were adopted, i.e. for the headlamp mounting height being equal to the lowest permissible value of 0.5 m and for the cut-off inclination being -2.5% [15], and the results were compared with those recorded for the nominal cut-off inclination of -1.0% . This comparison has been presented for headlamps Nos. 1 and 3 in Fig. 16.

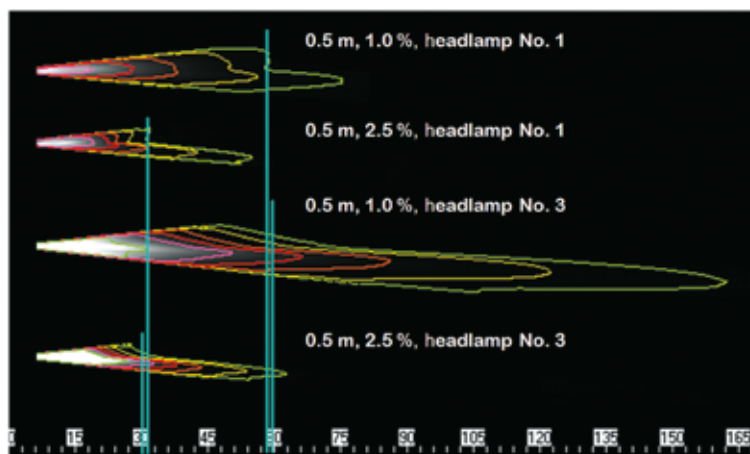

Fig. 16. Distribution of vertical illuminance at the road surface for the lowest headlamp mounting height

It can be noticed that on the left vehicle side, the road illumination range is similar for both headlamps and can be doubled or reduced by a half when the cut-off inclination is changed within the acceptable tolerance range. As regards the maximum values of the road illumination range on the right vehicle side, this range at the slightest inclination (-1.0%) may be about 2.5 times longer, depending on the shape of the light beam. For the strongest allowable inclination (-2.5%) [15], however, the road illumination ranges of the headlamps having the worst and the best light beam characteristics are almost identical and equal to about 50–60 m for the 1 lx isolux contour.

7. Recapitulation

The range of road illumination by the passing-beam headlamps, regardless of the definition-formulating difficulties as well as the properties of the object to be identified as an obstacle and of driver's eyesight, may vary within a very wide range for the headlamp photometric characteristics and installation specifications permitted by the type-approval regulations in force. The road illumination range depends on both the luminous flux emitted by the light source and individual headlamp design features, while these factors are in practice extremely diversified. On the other hand, it is not subject to any verification by measurements in the vehicle operation practice. It is also very strongly affected by the headlamp mounting height and current inclination of the light beam. An additional factor that can make the situation even worse is low accuracy of aiming the headlamps if very simple optical instruments are used for this purpose.

Therefore, the estimation of the road illumination range and attempts to estimate the distance from which the driver would be capable to notice an obstacle are at present very difficult, if possible at all, especially if the headlamps are destroyed after a road incident. Making a reference to the nominal isolux distributions on the road surface, made sometimes available e.g. by manufacturers, is unreliable because the actual values may be many times higher or lower than the nominal data due to actual headlamp settings, wear, or contamination, possible substitute headlamps installed, specific mass-produced bulbs used, changes in the light beam inclination due to varying vehicle load, setting of the manual headlamp-levelling system, etc. The use of "all-purpose" approximate graphs is incorrect because, as it has been shown above, the actual patterns of illuminance distribution at the road surface may differ very much from each other.

In consideration of results of statistical survey of the actual headlamp aiming in vehicles being in use, carried out by the author within project "Initiatives for good motor vehicle lighting" run by the Motor Transport Institute in Warsaw [22], an assumption may be made with high probability that the headlights of nearly a half of such vehicles do not ensure adequate visibility in most of the typical road traffic conditions. Similarly, a substantial proportion of the headlamps being in use causes dazzling and may be a reason for many road incidents, such as e.g. those described at the beginning of this paper.

The only reliable method of verifying the lighting quality after a road incident is to carry out measurements on undamaged headlamps without removing them from the vehicle,

with the use of e.g. a "Headlamp analyser", in conditions identical to those prevailing at the time of the incident, especially at identical distribution of vehicle loads and setting of the manual headlamp-levelling system. In practice, such requirements can only be fulfilled in exceptional circumstances, when the collision has not caused the vehicle headlamps to be damaged or the headlamp aiming to be changed.

As a remedy for the situation as described herein, substantial changes should be introduced in the system of vehicle lighting requirements, which should include narrowing of the headlamp aiming tolerances (with e.g. introduction of obligatory automatic dynamic levelling of all the vehicle headlamps) and precise adjusting and measuring of the headlight beam distribution during periodic vehicle inspections, preferably with recording the measurement results. Such a measurement record might provide a reliable reference that would make it possible to carry out subsequent analyses in case of an accident during which the headlamps would be damaged.

On the other hand, it should be noticed that, paradoxically, both the headlamp manufacturing technology and the headlamp examination possibilities have reached such a development stage that the vehicle headlighting would be capable to ensure safe travelling at night with currently permissible speeds in overwhelming majority of road traffic situations.

References

- [1] <http://www.echodnia.eu/apps/pbcs.dll/article?AID=/20131226/POWIAT0201/131229485>
- [2] <http://olsztyn.wm.pl/187400,Wypadek-pod-Olsztynem-Auto-quotwbilo-siequot-w-ciezarowke.html#axzz2rDUkibqD>
- [3] <http://raportdrogowy.interia.pl/aktualnosci/news-tragiczny-wypadek-w-jadownikach-zginela-rodzina,nld,1473747,th,77697526>
- [4] <http://www.gazetalubuska.pl/apps/pbcs.dll/article?AID=/20140820/powiat23/140829972>
- [5] "Road Traffic Law" Act of 20 June 1997 (Dz. U. No. 108 of 2005, item 908, with later amendments).
- [6] Rozporządzenie Ministra Infrastruktury z dnia 31 grudnia 2002 r. w sprawie warunków technicznych pojazdów oraz zakresu ich niezbędnego wyposażenia (Regulation of the Minister of Infrastructure of 31 Dec. 2002 on technical requirements for vehicles and on the scope of necessary vehicle equipment). (Dz. U. No. 32 of 2003, item 262, with later amendments).
- [7] Agreement concerning the adoption of uniform technical prescriptions for wheeled vehicles, equipment and parts which can be fitted and/or be used on wheeled vehicles and the conditions for reciprocal recognition of approvals granted on the basis of these prescriptions. Geneva, 1958.
- [8] Uniform provisions concerning the approval of filament lamps for use in approved lamp units on power-driven vehicles and of their trailers. UN ECE Regulation No. 37.
- [9] Uniform provisions concerning the approval of gas-discharge light sources for use in approved gas-discharge lamp units of power-driven vehicles. UN ECE Regulation No. 99.
- [10] Uniform provisions concerning the approval of light emitting diode (LED) light sources for use in approved lamp units on power-driven vehicles and their trailers. UN ECE Regulation No. 128.
- [11] Uniform provisions concerning the approval of motor vehicle headlamps emitting an asymmetrical passing beam or a driving beam or both and equipped with filament lamps and/or light-emitting diode (LED) modules. UN ECE Regulation No. 112.
- [12] Uniform provisions concerning the approval of motor vehicle headlamps equipped with gas-discharge light sources. UN ECE Regulation No. 98.

- [13] *Uniform provisions concerning the approval of adaptive front lighting systems (AFS) for motor vehicles.* UN ECE Regulation No. 123.
- [14] *Uniform provisions concerning the approval of motor vehicle headlamps emitting a symmetrical passing beam or a driving beam or both and equipped with filament, gas-discharge light sources or LED modules,* UN ECE Regulation No. 113.
- [15] *Uniform provisions concerning the approval of vehicles with regard to the installation of lighting and light-signalling devices.* UN ECE Regulation No. 48.
- [16] *Uniform provisions concerning the approval of category L3 vehicles with regard to the installation of lighting and light-signalling devices.* UN ECE Regulation No. 53.
- [17] *Uniform provisions concerning the approval of motor vehicle headlamps emitting an asymmetrical passing beam and/or a driving beam and equipped with filament lamps of categories R2 and/or H51.* UN ECE Regulation No. 1.
- [18] *Uniform provisions concerning the approval of motor vehicle headlamps emitting an asymmetrical passing beam or a driving beam or both and equipped with halogen filament lamps (H1, H2, H3, HB3, HB4, H7, H8, H9, HIR1, HIR2 and/or H11).* UN ECE Regulation No. 8.
- [19] *CIE 188 Technical Report: Vehicle Headlighting Systems Photometric Performance – Method of Assessment.* 2010.
- [20] TARGOSIŃSKI, T.: *Analizator plamy świetlnej reflektorów samochodowych - nowa jakość w badaniach eksploatacyjnych pojazdów (Analysis of quality of road illumination by headlamps on field conditions).* Przegląd Elektrotechniczny, Vol. 90, No. 1/2014.
- [21] *Rozporządzenie Ministra Transportu, Budownictwa i Gospodarki Morskiej z dnia 26 czerwca 2012 r. w sprawie zakresu i sposobu przeprowadzania badań technicznych pojazdów oraz wzorów dokumentów stosowanych przy tych badaniach (Regulation of the Minister of Transportation, Construction, and the Maritime Economy of 26 June 2012 on the scope and method of carrying out technical inspections of vehicles and on the standard forms to be used at such inspections).*
- [22] http://www.swiatla.its.waw.pl/Wyniki_akcji_badania_swiatel,3462.html