

PIOTR SOBOTA*

**COMPARISON OF CONVENTIONAL SPROCKET DRUM AND SPROCKET DRUM
WITH MODIFIED DESIGN****PORÓWNANIE BĘBNA ŁAŃCUCHOWEGO KONWENCJONALNEGO
I O ZMODYFIKOWANEJ KONSTRUKCJI**

Seats in conventional sprocket drums are symmetrical. Due to the set general direction of sprocket drum revolutions resulting from the direction of rock transport, the wear of the seat bottoms and teeth flanks may be reduced by introducing the asymmetry of the profile of the sprocket drum seats. The proposed modification of sprocket drum seats' profile consists of inclining the seat bottom towards the expected direction of the basic drum revolutions.

The work compares the loads on the seats and teeth of a conventional drum with its profile conforming to the standard to a modified drum with an asymmetric profile of seats. For the general direction of sprocket drum revolutions, the maximum values of all forces are higher for a standard drum than for a modified drum. The profile asymmetry substantially shortens the friction path of the horizontal link front torus on the seat bottom and relative total friction work on the seat bottom and lessens the occurrence probability of the slide of the horizontal link rear torus on the tooth flank. The modification of the profile causes also the asymmetric wear of link joints. The total relative friction work is considerably reduced in the front joint as compared to a conventional drum, and the total relative friction work in the rear joint is increasing at the same time.

Keywords: armoured face conveyor, sprocket drum, asymmetric profile of seat

Podstawową maszyną ścianowego kompleksu zmechanizowanego jest przenośnik zgrzeblowy. Ze względu na duże moce napędów wysoko wydajnych przenośników ścianowych bębny łańcuchowe przenoszą wysokie momenty obrotowe z reduktorów napędów i zazębiając się z torusami tylnymi ogniw poziomych łańcucha przekazują łańcuchowi zgrzeblowemu siłę pociągową. W czasie eksploatacji ścianowego przenośnika zgrzeblowego następuje – głównie na skutek zużycia ściernego – zwiększenie podziałki łańcucha ogniowego i zmniejszenie podziałki bębna łańcuchowego. Wchodzeniu ogniw łańcucha o zwiększonej podziałce w ząbienie z segmentami zębów bębna w warunkach poślizgu ogniw na flance zęba towarzyszą znaczące siły nacisku i tarcia, mające decydujący wpływ na zużycie segmentów zębów bębna. Uprzywilejowany kierunek ruchu łańcucha transportującego urobek determinuje zasadniczy kierunek obrotów bębna łańcuchowego, co wpływa na asymetryczne zużywanie się den gniazd

* INSTITUTE OF MINING MECHANISATION, FACULTY OF MINING AND GEOLOGY, SILESIA UNIVERSITY OF TECHNOLOGY, AKADEMICKA 2, 44-100 GLIWICE, POLAND

i segmentów zębów. W bębnach łańcuchowych o dużym stopniu zużycia widoczne są istotne różnice zarówno w wielkości zużycia jak i stereometrii gniazda po stronie napędowej stykającej się z torusem tylnym ogniwa poziomego oraz biernej współdziałającej z torusem przednim ogniwa poziomego (Rys. 1).

W bębnach łańcuchowych konwencjonalnych gniazda są symetryczne. Symetralna dna każdego z gniazd przechodzi przy tym przez oś obrotu bębna. Ze względu na założony zasadniczy kierunek obrotów bębna łańcuchowego, wynikający z kierunku transportowania urobku, sposobem zmniejszenia zużycia den gniazd i flank zębów może być wprowadzenie asymetrii zarysu gniazd bębna łańcuchowego. Proponowana modyfikacja zarysu gniazd bębna łańcuchowego polega na pochyleniu dna gniazda w stronę przewidywanego kierunku zasadniczych obrotów bębna w taki sposób, że symetralna dna gniazda będąca prostą prostopadłą do dna gniazda poprowadzoną w środku długości gniazda jest oddalona od osi obrotu. Asymetria zarysu daje możliwość zmiany stosunku wartości kąta α_1 obrotu torusa przedniego ogniwa poziomego nabiegającego na bęben względem dna gniazda, do wartości kąta α_2 obrotu ogniwa pionowego względem poprzedzającego go ogniwa poziomego (Rys. 3).

W zakresie obrotu bębna łańcuchowego o kąć podziałowy wyróżnia się trzy przedziały charakteryzujące się odmiennym sposobem obciążenia elementów bębna łańcuchowego. Przy współdziałaniu bębna łańcuchowego z łańcuchem o zwiększonych podziałkach ogniw, wzrasta kąt nachylenia ogniw poziomych względem den gniazd koła, przy czym dla bębna o zmodyfikowanym zarysie gniazd wartość tego kąta rośnie ze wzrostem podziałki ogniw wolniej niż dla bębna konwencjonalnego. Równocześnie ze wzrostem podziałki ogniw skraca się czas trwania pierwszego przedziału obrotu bębna o kąt podziałowy, czemu towarzyszy zmniejszanie wartości maksymalnej reakcji pomiędzy torusem przednim ogniwa poziomego a dnem gniazda. Ze względu na asymetrię zarysu gniazda wartość pierwszego przedziału obrotu bębna o kąt podziałowy jest zdecydowanie mniejsza dla bębna zmodyfikowanego niż dla konwencjonalnego (Rys. 4). Wzrost podziałki ogniw powoduje wzrost maksymalnej wartości siły w punkcie styku torusa tylnego ogniwa poziomego z powierzchnią roboczą zęba. Dla bębna o zmodyfikowanym zarysie maksymalna wartość tej siły wzrasta szybciej niż dla bębna konwencjonalnego, jednak siła ta ma wartość zawsze mniejszą niż dla bębna konwencjonalnego (Rys. 5). Wartości maksymalne wszystkich sił są wyższe dla bębna normowego niż dla zmodyfikowanego. Ponadto w końcowym zakresie obrotu bębna konwencjonalnego o kąt podziałowy, dla zachowania równowagi ogniwa poziomego niezbędna jest siła tarcia pomiędzy torusem tylnym ogniwa poziomego a flanką zęba, co zwiększa prawdopodobieństwo wystąpienia poślizgu ogniwa w stronę dna gniazda.

Wyznaczono pracę tarcia ogniwa poziomego na dnie gniazda i na flance zęba oraz pracę tarcia w przegubach ogniw dla bębna konwencjonalnego o normowym zarysie gniazd i dla bębna asymetrycznego o zmodyfikowanym zarysie gniazd. Wartość względnej sumarycznej pracy tarcia przy poślizgu torusa przedniego ogniwa poziomego na dnie gniazda dla bębna zmodyfikowanego jest kilkakrotnie mniejsza niż dla bębna konwencjonalnego (Rys. 7). Im większy wzrost wydłużenia podziałki ogniw łańcucha współdziałającego z bębniem tym większe procentowe zmniejszenie pracy tarcia na dnie gniazda zmodyfikowanego (Rys. 8).

Pracę tarcia podczas poślizgu torusa tylnego ogniwa poziomego po flance zęba wyznaczono całkowitą numerycznie iloczyn drogi poślizgu i odpowiedniej wartości siły tarcia w punkcie styku ogniwa z flanką zęba w chwili wystąpienia poślizgu. W trzecim przedziale obciążenia, w którym może dojść do poślizgu ogniwa poziomego po flance zęba, wartość siły w punkcie styku torusa tylnego ogniwa poziomego z flanką zęba jest dla bębna konwencjonalnego zawsze większa niż w bębnie zmodyfikowanym. Ze względu na mniejszą wartość kąta nachylenia ogniwa poziomego do dna gniazda w bębnie zmodyfikowanym, droga poślizgu na flance zęba również jest mniejsza. Z tych powodów, w przypadku wystąpienia poślizgu ogniwa poziomego po flance zęba, wartość pracy tarcia na flance zęba w bębnie asymetrycznym o zmodyfikowanym zarysie jest mniejsza niż w bębnie konwencjonalnym.

W czasie obrotu bębna łańcuchowego o kąt podziałowy następuje wzajemny obrót ogniw w przegubie przednim i w przegubie tylnym. Dla określonych warunków tarcia oraz znanego obciążenia ogniw wyznaczono pracę tarcia w przegubie przednim i przegubie tylnym przy obrocie bębna łańcuchowego o kąt podziałowy, uwzględniając fazę toczenia się ogniw i fazę poślizgu ogniw w przegubach (Rys. 10). Skróceniu w bębnach zmodyfikowanych ulega faza poślizgu ogniw w przednim przegubie ogniwa poziomego. Powoduje to znaczne zmniejszenie sumarycznej względnej pracy tarcia w przegubie przednim w porównaniu z bębniem konwencjonalnym oraz równoczesne zwiększenie sumarycznej względnej pracy tarcia w przegubie tylnym. Suma względnej pracy tarcia w przegubie przednim i tylnym jest przy tym niemal jednakowa dla bębnów konwencjonalnych i zmodyfikowanych.

Wykonano bęben łańcuchowy o zmodyfikowanej konstrukcji oraz zastosowano go w przenośniku ścianowym RYBNIK-850 (Rys. 11). Jest on obecnie eksploatowany już w drugim wyrobisku ścianowym

w KWK „Chwałowice”. Obserwacje ruchowe w warunkach eksploatacyjnych oraz kontrola stopnia zużycia bębna łańcuchowego o zmodyfikowanej stereometrii potwierdzają przydatność przyjętych założeń oraz zastosowanych rozwiązań konstrukcyjnych.

Słowa kluczowe: ścianowy przenośnik zgrzeblowy, bęben łańcuchowy, asymetryczny zarys gniazda

1. Introduction

The mining machinery operated in underground headings of hard coal mines are the subject of intensive scientific research (Krauze et al., 2009; Wölfe et al., 2000; Zhang, 2011). An armoured face conveyor is the basic machine of an integrated longwall system. A sprocket drum is one of the most important parts of an armoured face conveyor drive system. It intermediates in the transfer of the hauling force produced by a driving motor onto the scraper chain. The chain is transporting the mined rock along the conveyor route. Scraper chains consisting of two bands of a link chain connected with scrapers are used in the armoured face conveyors currently produced. A link chain, in terms of interworking with a seat wheel of a sprocket drum, is composed of alternate active horizontal links and passive vertical links. The active links interwork with the teeth and bottoms of the drum seats, while passive links act as connectors. Horizontal links have the form of flattened rings in which two tori can be differentiated: a front and rear torus. Due to the shape of the chain links, the intertooth spaces of sprocket wheels have the form of seats. Horizontal chain links are arranged in such seats, while vertical links are positioned in tooth grooves. Tooth grooves for vertical links and recesses for a scraper are significantly decreasing the area of seat bottoms. Sprocket drums are transmitting a high torque from the drive reducers and by meshing with the rear tori of the chain horizontal links are transmitting hauling force onto the scraper chain. Due to high capacities of drives of high-performance longwall conveyors, such chains tend to be larger and larger. $2 \times 34 \times 126$ mm and $2 \times 42 \times 146$ mm chains are commonly used in the currently operated longwall conveyors.

The link chain pitch is increasing and the sprocket drum pitch is decreasing during the operation of an armoured face conveyor – mainly due to wear. The actual pitch of chain links due to friction on the link joints when the chain is running on and unwinding from the sprocket drum is increasing over the technological pitch p of the link chain. The increased length of the chain pitch resulting from the abrasive wear of links in the joints and chain production tolerances, i.e. Δp , is most often described by a relative increase in the pitch in relation to the technological pitch $\Delta p/p$. The meshing of the chain links with the increased pitch with the drum teeth segments in the sliding conditions of teeth on the tool flank are accompanied by significant pressing and friction forces having decisive influence on the wear of the drum teeth segments. The bottoms of seats in contact with link tori are also subject to abrasive wear. The deforming wear of bottom seats and working surfaces of teeth may be the result of long-lasting interwork of horizontal links with seat bottoms.

A privileged travelling direction of the chain transporting the output is determined by the general direction of sprocket drum revolutions which influences the asymmetric wear of seat bottoms and tooth segments. Large differences are seen in highly worn sprocket drums, both in the degree of wear and seat stereometry on the driving side contacting with the horizontal link rear torus and on the passive side mating with the horizontal link front torus (Fig. 1). The bottom seat on the side mating with the horizontal link front torus in the presented sprocket drum

is highly worn over a small area, as a result of which the horizontal link is subsiding deep below the nominal surface of the seat bottom. The wear of the non-working tooth flank is insignificant here as compared to the tooth working surface on the driving side.

As a result of the interworking sprocket drums with a worn scraper chain, sprocket drums are currently the least durable part of an armoured face conveyor. Sprocket drums in face conveyors are replaced with new ones every several months of use due to a high degree of wear. The gradual wear of the drum is affecting adversely the effective meshing of the sprocket drum with the mating chain link. An improved life of sprocket drums is therefore a prerequisite for ensuring high reliability of armoured face conveyors which are an important part of the mechanisation systems used for extracting coal deposits with longwall systems.

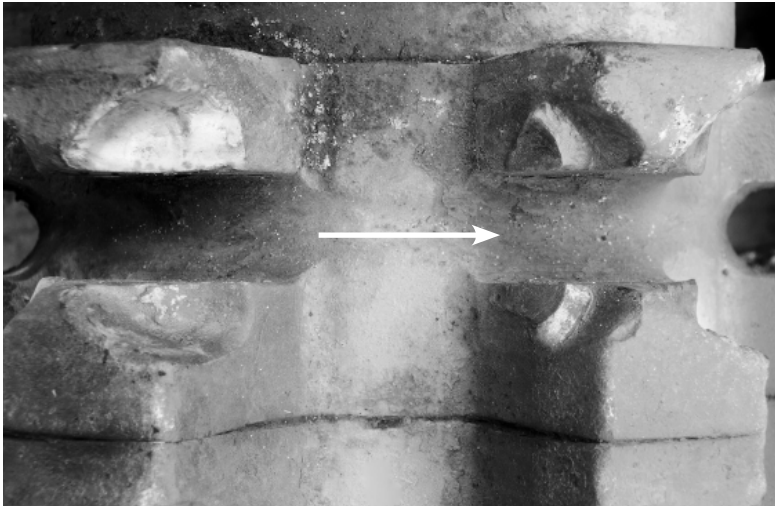

Fig. 1. Sprocket drum tooth with high degree of wear

2. Position of links

Geometrical relationships between the chain and the sprocket drum and the friction conditions existing in the joints of links are determining the position of links in the drum seats. When a sprocket drum is interworking with a chain with the elongated pitch, the running-on horizontal link does not contact the seat bottom along its entire length. This meshing variant is characterised by the fact that the horizontal chain links positioned on the sprocket drum with the number of teeth z are inclined relative to the seat bottoms under the angle ε so that their front tori are contacting the seat bottoms and the rear tori are contacting the working sides of the drum teeth segments with the inclination angle relative to the seat bottom β (Fig. 2). The following parameters are determined in order to clearly describe the position of the chain links in the drum seats (Dolipski et al., 2010):

- the links' inclination angle relative to the bottoms of the drum seats ε ;
- the distance between the centre of the joint with the front torus of the horizontal link from the beginning of the side of a regular polygon u ;

- the rotation angle of the vertical link relative to the preceding horizontal link in the middle of the joint with the horizontal link rear torus α'' .

The longer relative elongation of the pitch the greater values achieved by the parameters describing the position of links in the sprocket wheel seats (ε , u and α'').

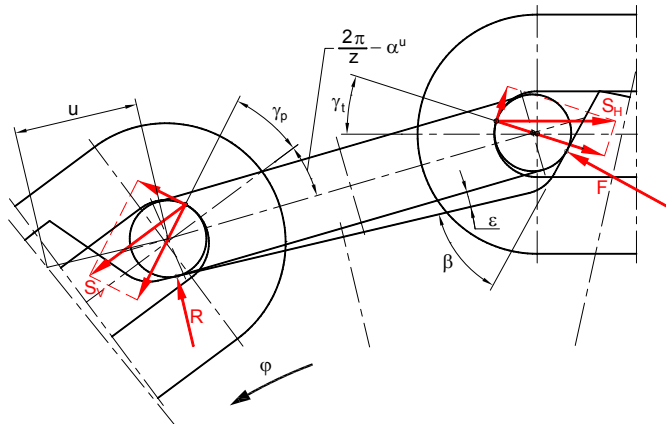

Fig. 2. Load on the horizontal link contacting the front torus with the seat bottom and rear torus with the side surface of tooth

The mobility effect of links in joints, when the links are tilting mutually, has been considered when analysing the interworking of the sprocket drum with the link chain, the result of which is the displacement of the contact point of the links. The tilting of the horizontal link relative to the vertical link is accompanied by the rolling of the horizontal link relative to the vertical link as a result of friction prevailing in the joint or by the slide of links in the joint depending on the joint module value and the friction coefficient value in the joint μ^p . When a horizontal link is rolling in the joint, with the rolling friction coefficient f^p , the contact point of the links is displacing in the front joint by the angle γ_p and in the rear joint by the angle γ_r , and the position of the contact point in the vertical link joint remains unchanged during the slide of the link.

3. Modification of design

Seats in conventional sprocket drums whose shape and basic dimensions are stated in the standard PN-G-46703:1997 are symmetric. A perpendicular bisector of each seat bottom is passing through the drum rotation axis. Due to the set general direction of sprocket drum revolutions resulting from the direction of rock transport, the wear of the seat bottoms and teeth flanks may be reduced by introducing the asymmetry of the profile of the sprocket drum seats. The proposed modification of sprocket drum seats' profile consists of inclining the seat bottom towards the expected direction of the basic drum revolutions in such a way that the perpendicular bisector of the seat bottom being a line perpendicular to the seat bottom led in the centre of the seat length, is not going through the revolution axis of the drum but is away from the axis of revolution by the distance r (Fig. 3) (Dolipski et al., 2011). In terms of design, the modification causes the

displacement of the seat profile and reduction in distance between the seat bottom and the axis of revolution in relation to the standard dimension. The asymmetric position of the seat bottom also causes the asymmetry of the inclination angles of the tooth β_1 and β_2 flank on the both sides of the tooth segment. The shape of the seat may remain in accordance with the standard. By introducing an asymmetric profile, the revolution angle value ratio is changed of the front torus of the horizontal link running on the drum in relation to the seat bottom, to the vertical link revolution angle value in relation to the preceding horizontal link. The rotation of the front torus of the horizontal link running on the drum relative to the seat bottom is lasting from the moment the horizontal link front torus is contacting the seat bottom until the rear torus of this horizontal link is contacting the tooth flank. The rotation of the vertical link in relation to the preceding horizontal link is lasting from the moment the horizontal link rear torus is contacting the tooth flank until the front torus of next horizontal link is contacting the bottom of the next seat. Profile asymmetry gives a possibility to change the α_1 value angle ratio of rotation of the horizontal link front running on the drum relative to the seat bottom, in relation to the α_2 angle value of the rotation of the vertical link in relation to the preceding horizontal link, as a result of which a friction path can be shortened of the horizontal link front torus against the seat bottom and the rotation angle of the vertical link can be extended relative to the preceding horizontal link (Fig. 3). The ratio value of angles of $\alpha_1/\alpha_2 = 0.5$ was used in the solution proposed for studies. The value is therefore decreased of the angle α_1 of rotation of the horizontal link front torus running on the drum relative to the seat bottom. The angle α_2 value of the rotation of the vertical link changes in relation to the preceding horizontal link, though. The purpose of the proposed modification of the sprocket drum seat profile is to reduce the wear of seat bottoms and tooth flanks with the general direction of sprocket drum revolutions consistent with the transport direction of output within the longwall.

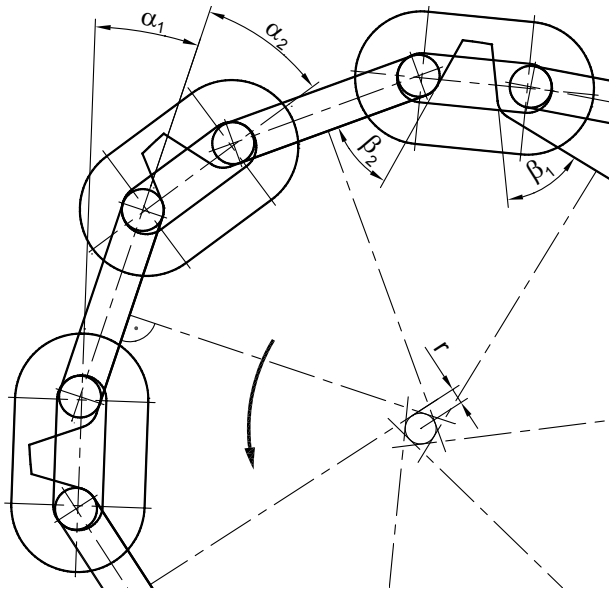

Fig. 3. Asymmetric position of the seat bottom

4. Comparison of load

Due to the repeatability of the links' position in the sprocket drum seats with the number of teeth z , when the teeth are running on, the relevant seats bottoms, teeth flanks and chain links are loaded cyclically when the sprocket drum is rotated by the pitch angle of $\varphi = 2\pi/z$. It was assumed when analysing the loading of the sprocket drum elements that the drum rotation angle is changing from the moment the front torus of the running-on horizontal link is contacting the seat bottom ($\varphi = 0$) until the front torus of another horizontal link is contacting the bottom of the next seat ($\varphi = 2\pi/z$). Three intervals, characterised by the varied loading of the sprocket drum parts, are differentiated for sprocket drum rotation by the pitch angle.

The first pitch angle interval lasts from the moment the front torus of the horizontal front link contacts the seat bottom until the moment the rear torus of the horizontal link contacts the tooth flank. Within this range, the link that is meshed is loaded with the run-on force S_H , with the force S_V conveyed onto the preceding vertical link and with the reactive force R between the front torus of the horizontal link and the seat bottom. The slide of the front torus on the bottom seat is causing the friction force perpendicular to the reaction R dependent on the friction coefficient value between the front torus of the link and the seat bottom μ^g .

The second interval lasts from the moment the rear torus of the horizontal link is contacting the tooth flank until the reaction R reaches a zero value. The horizontal link is loaded with the run-on force S_H , reactive force R at the contact point with the seat bottom, with the reactive force F in the contact point of the rear torus with the tooth flank and with the force S_V transmitted onto the preceding vertical link (Fig. 2).

The third interval commences from the moment where the value of the reaction R falls to zero and lasts until the front torus contacts the next horizontal link with the bottom of the next seat. In the third interval, the force T occurs on the tooth flank, perpendicular to the reaction F , necessary for maintaining the balance of the horizontal link, preventing the slide of the rear torus of the horizontal link at the tooth flank towards the seat bottom. If the reaction R in the second interval does not reach the zero value until the moment the front torus of the next horizontal link contacts the bottom of the next seat, then no third interval occurs.

A load was determined on the segments of teeth and seat bottoms of the chosen, modified design of the sprocket drum with the number of teeth $z = 7$. A rectilinear shape of the tooth flank was assumed here which, from the side of the front torus of the horizontal link, is inclined to the seat bottom under angle $\beta_1 = 52^\circ$, and from the side of the horizontal link rear torus is inclined to the seat bottom under the angle $\beta_2 = 40^\circ$. A load on the segments of teeth and bottoms of seats of the modified drum were compared with the values calculated for a conventional symmetric chain drum with parameters compliant with the standard PN-G-46703 with the tooth flank inclination angle of $\beta = 60^\circ$. The both drums were interworking with a scraper chain sized $2 \times 34 \times 126$ mm.

For a chain with the pitches of links elongated by $\Delta p/p = 0.5\%$, when the links are meshed with the drum teeth segments with a modified profile, with minimum values of friction coefficients of $\mu^p = 0.1$ and $\mu^g = 0$, non-linear growth of the force value S_V is seen in the first interval of drum revolution by the pitch angle in such a way that the ratio of forces S_V/S_H (Fig. 4) assumes values higher than unity and reaches the maximum of $S_V/S_H = 1.031$. The value of reaction between the horizontal link front torus and the seat bottom is also rising from zero until the end of this phase, i.e. until the horizontal link front torus contacts the tooth flank reaching the value $R/S_H = 0.248$. In the second interval of drum rotation by the pitch angle, the value of the forces S_V and R is

falling quickly due to part of the load received by the working surface of the tooth onto which a quickly rising force F is acting, reaching the maximum value of $F/S_H = 0.805$ (continuous lines in Fig. 4). As the value of the reaction R does not fall to zero during sprocket drum rotation by the pitch angle, no force T occurs on the flank preventing the slide of the rear torus of the horizontal link on the working surface of the tooth towards the seat bottom.

The first interval of drum rotation by the pitch angle for a conventional sprocket drum working in the same conditions ($\Delta p/p = 0.5\%$, $\mu^p = 0.1$, $\mu^g = 0$) lasts much longer. For this reason, the forces loading the parts of the drum (intermittent lines on Fig. 4) reach higher maximum values of: $S_V/S_H = 1,074$; $R/S_H = 0,385$; $F/S_H = 0,985$. The value of the reaction R falls to zero for the drum rotation angle of $\varphi = 50.2^\circ$ during sprocket drum rotation by the pitch angle and the force T occurs preventing the slide of the horizontal link rear torus along the working surface of the tooth towards the seat bottom. A possibility of link slide on the tooth working surface depends on the friction coefficient value between the horizontal link rear torus and the tooth flank.

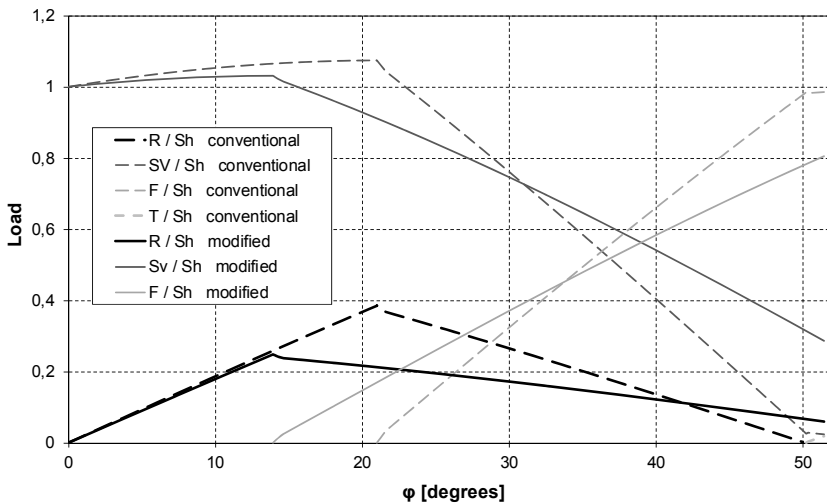

Fig. 4. Load curve of modified drum and conventional drum for $\Delta p/p = 0.5\%$, $\mu^p = 0.1$, $\mu^g = 0$

When a sprocket drum interworks with a chain with the increased pitches of links, the horizontal links' inclination angle relative to the bottoms of the drum seats ε is rising, and the value of this angle for drums with a modified profile of seats is rising slower, as the pitch of the links is increasing, than for a conventional drum. At the same time as the pitch of the links is increasing so is shortening the time of the first interval of drum revolution by the pitch angle, accompanied by a decreasing value of maximum reaction R between the front torus of the horizontal link and the seat bottom. Due to asymmetry in the seat profile, the value of the first interval of drum revolution by the pitch angle is decisively smaller for the modified drum than for the conventional drum. The maximum values of the ratio of forces R/S_H are also smaller and vary between the value of $R/S_H = 0.248$ for $\Delta p/p = 0.5\%$ to the value $R/S_H = 0.086$ for $\Delta p/p = 3.0\%$, and for a conventional drum, within the same variation range of the pitch of links, the values of the ratio of such forces decrease from $R/S_H = 0.385$ to $R/S_H = 0.192$ (Fig. 5). As the pitches

of the chain are increasing, so are decreasing slightly also the maximum values of the force S_V transmitted from a horizontal link onto the preceding vertical link, and for a drum with a modified profile, the maximum values of the ratio of forces S_V/S_H are always smaller than for a drum with a symmetric profile. If the pitch of links is increasing, this results in the higher maximum value of the force F at the contact point of the rear torus of the horizontal link with the side surface of tooth. For a drum with a modified profile, the ratio of maximum values of the forces F/S_H is growing faster than for a conventional drum, however, the ratio of such forces has always a smaller value than for a conventional drum. For a modified drum, the maximum values of the ratio of forces F/S_H also vary between the value of $F/S_H = 0.805$ for $\Delta p/p = 0.5\%$ to the value $F/S_H = 0.927$ for $\Delta p/p = 3.0\%$, and for a conventional drum, within the same variation range of the pitch of links, the maximum values of the ratio of such forces increase from $F/S_H = 0.985$ to $F/S_H = 0.999$ (Fig. 5).

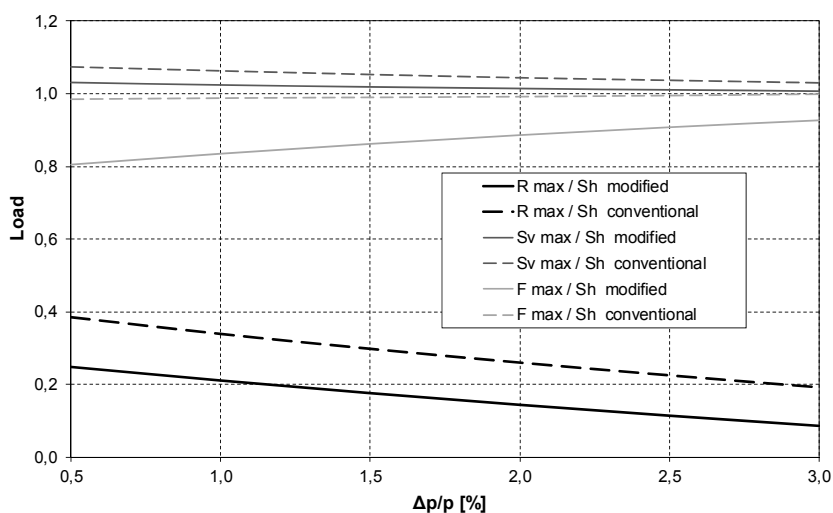

Fig. 5. Influence of elongation of links' pitches on the maximum values of the load ($\mu^p = 0.1$; $\mu^s = 0$)

For a chain with the pitches of links elongated by 3.0%, ($\mu^p = 0.1$ and $\mu^s = 0$), a load curve for a modified drum and conventional drum is shown in Fig. 6. The maximum values of all forces are higher for a standard drum than for a modified drum. Moreover, to maintain balance of the horizontal link in the final range of the conventional drum's rotation by the pitch angle, friction force is necessary between the rear torus of the horizontal link and the tooth flank, which increases the occurrence probability of slide of the link towards the seat bottom.

5. Comparison of friction work

It is necessary to determine friction work in the slide conditions of the horizontal link on the seat bottom and on the tooth flank and friction work in the joints of links in the context of such nodes' abrasive wear. The friction work of the friction couple of a sprocket drum – link

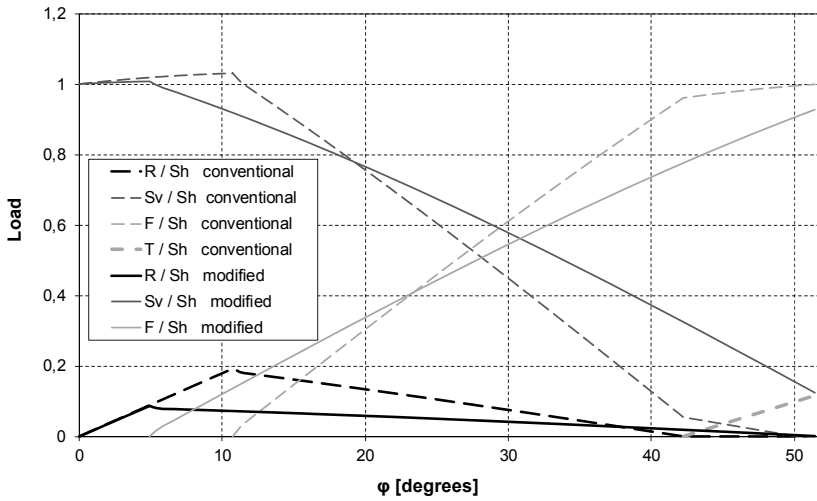

Fig. 6. Load curve of modified drum and conventional drum for $\Delta p/p = 3.0\%$, ($\mu^p = 0.1$; $\mu^s = 0$)

chain consists of friction work of the horizontal link in the places where it contacts with the seat bottom A_g and the tooth flank A_f and friction work in the joints of a horizontal link in the contact place with vertical links: in the front joint A_p and the rear joint A_t (Sobota, 2013). Different design variants of sprocket drums can be compared in this regard by determining friction. The friction work of the horizontal link on the seat bottom and on the tooth flank was therefore determined along with friction work in the joints of links for a conventional drum with a standard profile of seats and for an asymmetric drum with a modified profile of seats. Friction work was also determined as relative to the run-on force as A/S_H [J/kN] because the forces acting on the horizontal link were determined relatively in relation to the run-on force value.

Friction work during the slide of the horizontal link front torus on the bottom of the seat A_g was determined by integrating numerically the product of the friction path and the respective friction force value in the contact point between the link and the seat bottom. The value of relative total friction work for horizontal link front torus slide on the seat bottom during the rolling and slide of the links in the front joint is dependent on the elongation of the links' pitches. This is shown in Fig. 7 for $\Delta p/p = 0.5\%$.

As the elongation of the links pitch is growing, so is shortening the duration of the first stage of drum revolution, both, for a conventional and modified drum. The slide path of the horizontal link on the seat bottom is hence decreasing and the total friction work on the seat bottom. For a chain with the pitches of links elongated by $\Delta p/p = 3.0\%$, the value of relative total friction work for horizontal link front torus slide on the seat bottom is shown in Fig. 8.

The value of relative total friction work for horizontal link front torus slide on the seat bottom A_g for a modified drum is several times smaller than for a conventional drum. The higher growth of the elongation of the pitch of links of the chain interworking with a drum, the higher reduction in per cents of friction work on the bottom of the modified seat.

In the third interval, the force T occurs on the tooth flank necessary for maintaining the balance of the horizontal link, preventing the slide of the rear torus of the horizontal link at the tooth flank towards the seat bottom. If the value of the friction force induced by the pressing force F on

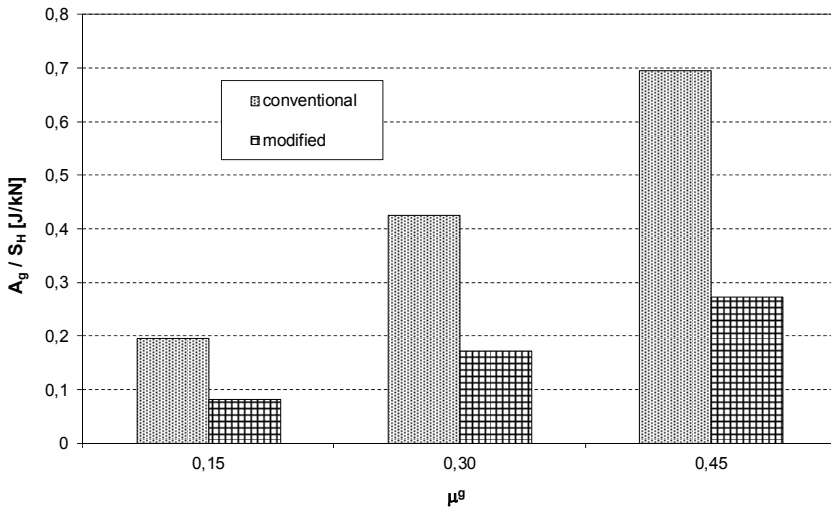

Fig. 7. Total relative friction work on the bottom of a modified drum and conventional drum for $\Delta p/p = 0.5\%$, ($\mu^p = 0.1$)

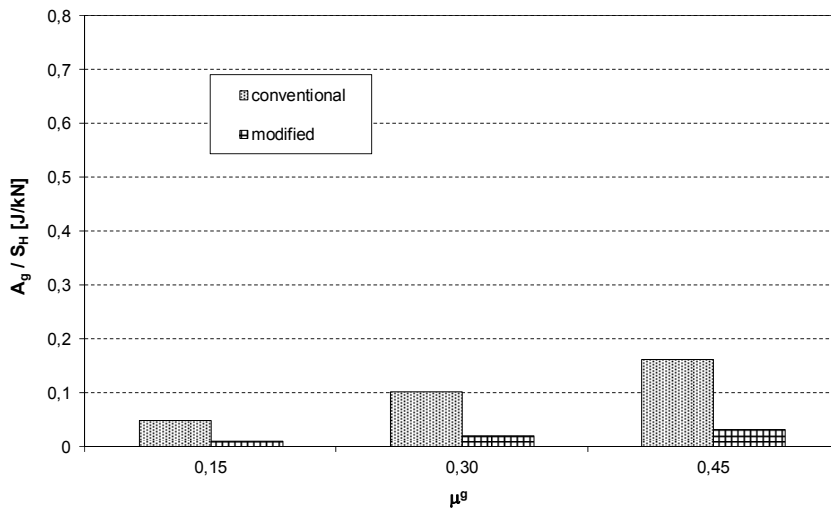

Fig. 8. Total relative friction work on the bottom of a modified drum and conventional drum for $\Delta p/p = 3.0\%$, ($\mu^p = 0.1$)

the tooth flank equals at least the value of the force T , then the system of forces is in balance. If, however, the friction force coming from the pressure on the tooth flank is smaller than the value of the force T , then the slide of the horizontal link rear torus on the tooth flank towards the seat bottom occurs. Friction work during the slide of the horizontal link rear torus on the tooth flank A_f was determined by integrating numerically the product of the slide path and the respective friction force value in the contact point between the tooth flank upon the occurrence of slide.

For the friction conditions of $\mu^p = 0.2$, $\mu^g = 0.15$ when drums are interworking with the chain with the pitches of links elongated by $\Delta p/p = 3.0\%$, the force T occurs on the tooth flank necessary for maintaining the balance of the horizontal link, both, for conventional drums and modified drums (Fig. 9).

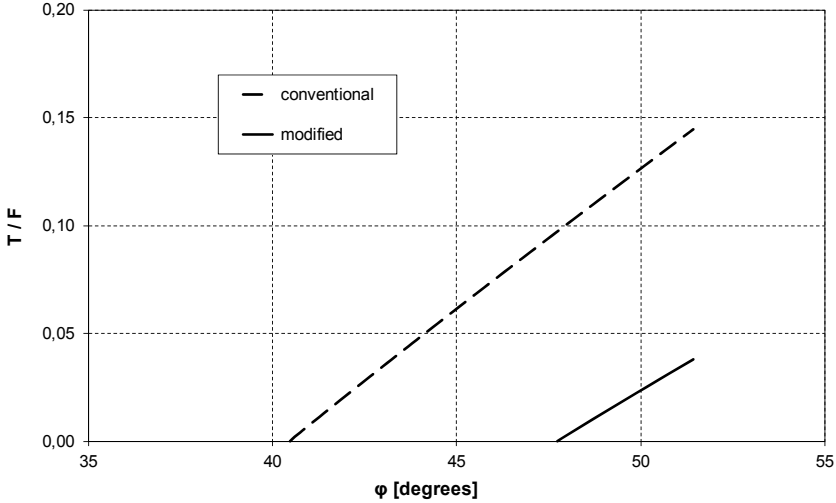

Fig. 9. Curve of the ratio of the forces T/F in conventional drums and modified drums for $\Delta p/p = 3.0\%$, $\mu^p = 0.2$, $\mu^g = 0.15$

If the friction coefficient value between the tooth flank and the horizontal link will be $\mu^f = 0.05$, then the slide of the link on the tooth flank will take place for the value of the ratio of forces of $T/F > 0.05$. This will take place only for a conventional drum and no conditions for slide will occur in a modified drum. Relative friction work on the tooth flank of a conventional drum will be then $A_f/S_H = 0.676$ [J/kN]. In the modified drums, the maximum value of the ratio of forces T/F occurs for $\phi = 2\pi/z$ and the possibility of slide exists only for the friction coefficient value $\mu^f < 0.038$.

In the third interval of loading where the slide of the horizontal link on the tooth flank may occur, the value of the force F at the contact point of the rear torus of the horizontal link with the tooth flank is always higher for a conventional drum than in a modified drum (Fig. 4, Fig. 6). As the value of the horizontal link's inclination angle in relation to the bottom of the seat ε in the modified drum is smaller, the slide path on the tooth flank is smaller, as well. For this reason, when the slide of the horizontal link on the tooth flank occurs, the value of friction work A_f in a modified drum with an asymmetric profile is smaller than in a conventional drum.

When a chain drum is rotated by the pitch angle, links are rotated relatively in the front joint and in the rear joint. Friction work in the front joint A_p and rear joint A_t for sprocket drum rotation by the pitch angle can be determined for specific friction conditions and the known load on the links. For chain drums interworking with the chain with the pitches of the chain elongated by $\Delta p/p = 1.0\%$ for the friction conditions of $\mu^g = 0.15$, $f^p = 0.05$ mm and $\mu^p = 0.2$, total relative friction work was determined in the joints of links considering the rolling phase of the links and the slide phase of the links in the joints (Fig. 10).

The first phase of drum rotation is shortened by the pitch angle by modifying the profile of drum seats. The phase of links rolling in the joint characterised by a low relative friction work value is not dependent on the change of the seats' profile. The slide phase of links in the horizontal link front joint is shortened in the modified drums. The total relative friction work is thus considerably reduced in the front joint as compared to a conventional drum, and the total relative friction work in the rear joint is increased at the same time. The value of relative total friction work in the rear joint is therefore increased in relation to the total relative friction work in the front joint A_t/A_p . The total relative friction work in the front joint and in the rear joint is almost identical for the conventional drums ($A_p + A_t = 2.903$ [J/kN]) and modified drums ($A_p + A_t = 2.854$ [J/kN]).

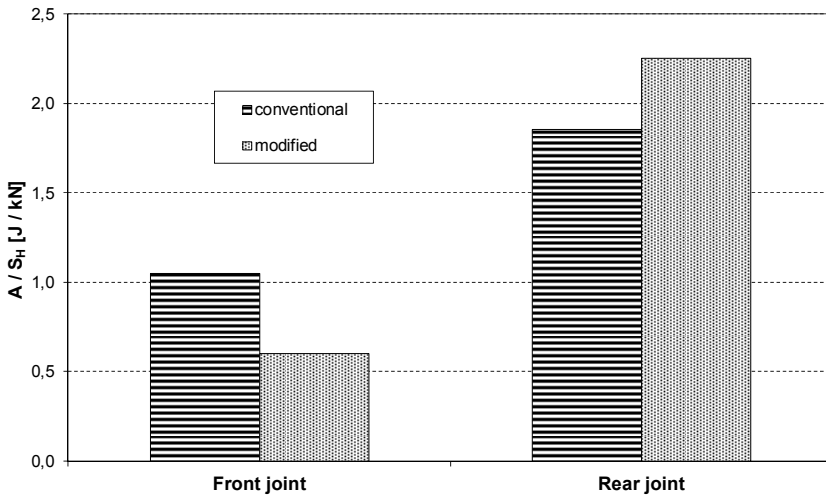

Fig. 10. Total relative friction work in the joints of chain links for $\Delta p/p = 2.0\%$, $\mu^p = 0.2$, $\mu^g = 0.15$

6. Conclusion

The developed modification of the design of sprocket drums for high-performance armoured face conveyors is characterised by a changed geometry of the seats' profile in relation to conventional drums. The modification introduced, consisting of the asymmetry of the profile of the tooth flank and seats' bottoms, has led to changes in the meshing conditions of horizontal links with sprocket drum teeth and, as a consequence, to shortening the friction path of the horizontal link front torus on the seat bottom and to reducing the total relative friction work on the seat bottom and to lessening the occurrence probability of the slide of the horizontal link rear torus on the tooth flank. The total relative friction work is considerably reduced in the front joint as compared to a conventional drum, and the total relative friction work in the rear joint is increased at the same time due to profile asymmetry. Profile modification leads to the reduced wear of sprocket drum seats' bottoms and teeth, contributing to its improved life.

Owing to collaboration between the Faculty of Mining and Geology of the Silesian University of Technology and Kompania Węglowa S.A. and Kopex Machinery (Ryfama S.A.), it was possible to develop a sprocket drum with modified design and to use it in the RYBNIK-850

longwall conveyor (Fig. 11). The conveyor is already used in the second longwall at “Chwałowice” Hard Coal Mine. Operational observations in working conditions and the control of the degree of wear of the sprocket drum with modified stereometry confirm that the assumptions made and the design solutions applied are helpful.



Fig. 11. Drum with the modified profile of seats designed for an armoured face conveyor

The work has been implemented under the development project No. N R09 0026 06/2009 financed by the Ministry of Science and Higher Education under decision No. 0481/R/T02/2009/06

References

- Dolipski M., Sobota P., Cheluska P., Giza T., Mann R., Osadnik J., Remiorz E., Kusak E., Tytko S., Łabęcki M., 2011. *Bęben łańcuchowy zwłaszcza do ścianowych przenośników zgrzeblowych*. Patent application P.396845 of 2.11.2011.
- Dolipski M., Remiorz E., Sobota P., Osadnik J., 2010. *Wpływ zwiększenia podziałki łańcucha na położenie jego ogniwi w gniazdach bębnow łańcuchowych*. *Wiadomości Górnicze*, No. 9.
- Krauze K., Kotwica K., Rączka W., 2009. *Laboratory and Underground Tests of Cutting Heads with Disc Cutters*. *Arch. Min. Sci.*, Vol. 54, No 2.
- Sobota P., 2013. *Determination of the friction work of a link chain interworking with a sprocket drum*. *Arch. Min. Sci.*, Vol. 58, No 3.
- Wölfle M., Flöte K., 2000. *Causes of Vibration and Stress Loadings of Chain-operated Face Equipment Resulting from Vibration*. *Konferenzmateriale “Hochleistung-Strebbetriebe”*. RWTH Aachen. Juni 2000, p. 137-154.
- Zhang Chunzhi, 2011. *Dynamic Modeling of Scraper Conveyor Sprocket Transmission and Simulation Analysis*. *International Conference on Mechatronics and Automation*, Beijing, China, p. 1390-1394.