



ARCHIVES  
of  
FOUNDRY ENGINEERING

DOI: 10.1515/afe-2017-0146

Published quarterly as the organ of the Foundry Commission of the Polish Academy of Sciences

ISSN (2299-2944)  
Volume 17  
Issue 4/2017

143 – 146

# Effect of Titanium Inoculation on Tribological Properties of High Chromium Cast Iron

D. Siekaniec <sup>a,\*</sup>, D. Kopyciński <sup>a</sup>, A. Szczęsny <sup>a</sup>, E. Guzik <sup>a</sup>, E. Tyrała <sup>a</sup>, A. Nowak <sup>b</sup><sup>a</sup> AGH University of Science and Technology, Department of Foundry Engineering,  
Al. Mickiewicza 30, 30-059 Kraków, Poland<sup>b</sup> Odlewnie Polskie S.A., Starachowice, Al. Wyzwolenia 70, 27-200 Starachowice, Poland

\* Corresponding author. E-mail address: e-mail: dsiek@agh.edu.pl

Received 26.04.2017; accepted in revised form 15.06.2017

## Abstract

The present investigation focuses on the study of the influence of titanium inoculation on tribological properties of High Chromium Cast Iron. Studies of tribological properties of High Chromium Cast Iron, in particularly the wear resistance are important because of the special application of this material. High Chromium Cast Iron is widely used for parts that require high wear resistance for example the slurry pumps, brick dies, several pieces of mine drilling equipment, rock machining equipment, and similar ones. Presented research described the effects of various amounts of Fe-Ti as an inoculant for wear resistance. The results of wear resistance were collated with microstructural analysis. The melts were conducted in industrial conditions. The inoculation was carried out on the stream of liquid metal. The following amount of inoculants have been used; 0.17% Fe-Ti, 0.33% Fe-Ti and 0.66% Fe-Ti. The tests were performed on the machine type MAN. The assessment of wear resistance was made on the basis of the weight loss. The experimental results indicate that inoculation improve the wear resistance. In every sample after inoculation the wear resistance was at least 20% higher than the reference sample. The best result, thus the smallest wear loss was achieved for inoculation by 0.66% Fe-Ti. There is the correlation between the changing in microstructure and wear resistance. With greater amount of titanium the microstructure is finer. More fine carbides do not crumbling so quickly from the matrix, improving the wear resistance.

**Keywords:** Mechanical properties, High chromium cast iron, Wear resistance, Inoculation, Titanium

## 1. Introduction

The High Chromium Cast Irons have been widely applied to wear resistant parts in steel making plants, power plants, mineral industry plants, and others. For many applications, a higher wear resistance is required to improve the service life of the wear components. Because of such many applications a higher wear resistance is required to improve the service life of the wear components [1-10].

Baotong Lu et al. in paper [2] investigated the effect of varying amounts of carbon and chromium on wear resistance. They concluded that there is a certain limit on the quantity of carbon - 2.2% beyond which the wear resistance decreases sharply (Fig. 1).

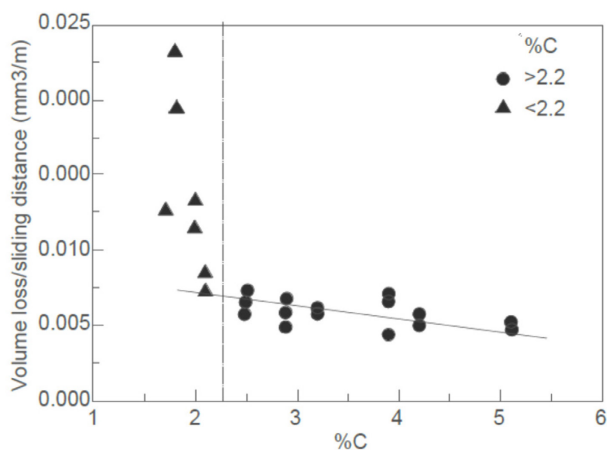

Fig. 1. Effects of carbon in white cast iron content on wear resistance [2]

They also investigated the chromium content, and the wear rate proved to be essentially independent of chromium content. From the Fig. 2 it can be found that three samples with high Cr content have a high material loss rate due to their low carbon content ( $C < 2.2\%$ ).

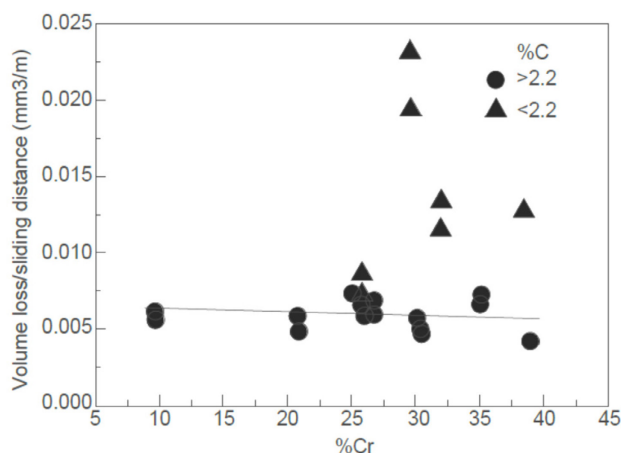

Fig. 2. Effects of chromium content white cast iron on wear resistance [2]

R.J. Chunga et al. in [3] studied the effect of Ti addition on the wear resistance of the hypereutectic high chromium cast iron

Table 1.

Chemical composition, wt. %

	C	Si	Mn	P	S	Cr	Ni	Ti
reference sample	1.807	0.769	0.469	0.017	0.0098	21.191	0.180	0.00356
0.17% Fe-Ti	1.777	0.791	0.469	0.017	0.0098	21.216	0.181	0.05990
0.33% Fe-Ti	1.770	0.768	0.417	0.019	0.0121	21.106	0.185	0.08817
0.66% Fe-Ti	1.672	0.770	0.427	0.017	0.0103	21.058	0.183	0.20431

(Fe – 25.0 wt.%Cr – 4.0 wt.%C). Authors added the different amount of Ti, respectively 1.0 wt. %Ti, 2.0 wt. %Ti and 6.0 wt. %Ti. The influence of Ti addition was examined using a pin-on-disc wear tester. During the wear test, a ball pin made of silica nitride of 6 mm in diameter slid on a flat sample under a normal load of 10N. The results are presented on Fig 3.

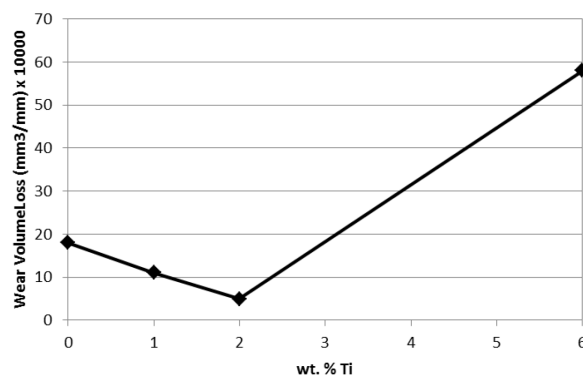

Fig. 3. Changes in the sliding wear volume loss of Fe – 25wt.%Cr – 4wt.%C with different amount of added titanium. [3]

It can be found that at the beginning with the increasing amount of Ti the wear resistance increase and then after exceeding 2 wt. %Ti, wear resistance decrease. Based on the research described in [3] the authors found that the microstructural refinement plays a predominant role in the improvement of the HCCI's wear resistance.

## 2. Methodology

The present investigation focuses on the study of the influence of inoculation of Fe-Ti on tribological properties of High Chromium Cast Iron. The melts were carried out in industrial conditions. Liquid metal overheated to 1600°C in induction furnace. The liquid metal poured from furnace to ladle. The inoculant was in powdered form with grain size less than 1 mm. The inoculation was carried out on the stream of liquid metal. The following amount of inoculants have been used; 0.17%Fe-Ti, 0.33%Fe-Ti and 0.66%Fe-Ti. The chemical composition of samples was measured by spectrometer, results are shown in Table 1.

Samples for microstructure analysis and sample for wear resistance with dimensions 20x10x10 mm cut from the casts. For each cast were measured two samples, the result is the mean of these measurements.

The wear resistance tests were performed on the machine type MAN. The schematic of the device is shown in Fig. 4.

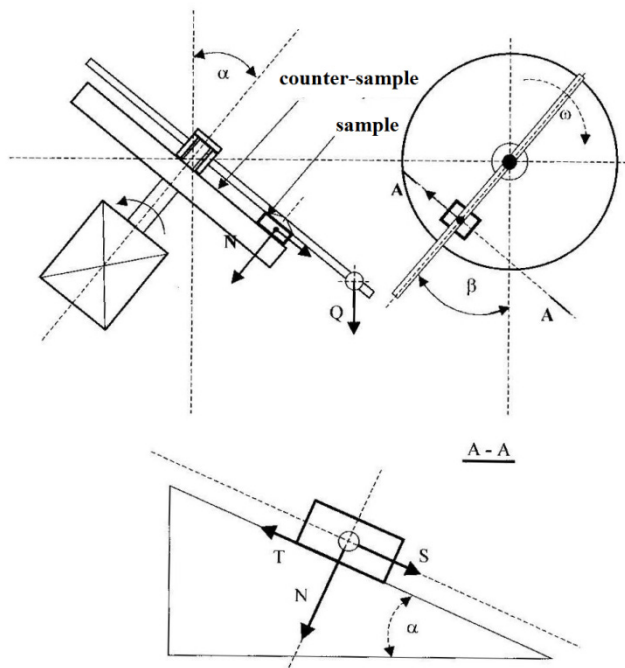

Fig. 4. The schematic of the measure of wear resistance

The samples weighed, and then attached to the arm. The sample was moving at a speed of  $v_1 = 80\text{km/h}$ , with water as a cooling medium, rubbing against the counter-sample. The measure of the wear resistance is the weight loss after 10, 20, 30, 80 km.

The samples were polished on the polishing discs of different gradation - 120, 220, 600, and 1200 at speed 300 rpm and pressure 30N. Then specimens were polished with diamond suspension (size 9 and 3 microns) and STRUERS lubricant. Samples were etched in Vilella reagent. Metallographic analysis was performed using an optical microscope MEF-4M LEICA.

## 3. Results and discussion

### 3.1. Wear resistance

The result of wear resistance is the weight loss - the smaller the loss, the highest the wear resistance. Table 2 and Fig 5 and 6 present the results.

Table 2.

Weight loss of the samples

distance km	reference sample	Weight loss, g		
		0.17% Fe-Ti	0.33% Fe-Ti	0.66% Fe-Ti
0	0	0	0	0
10	0.047	0.015	0.035	0.035
20	0.074	0.03	0.053	0.05
30	0.098	0.057	0.068	0.065
80	0.188	0.153	0.153	0.137

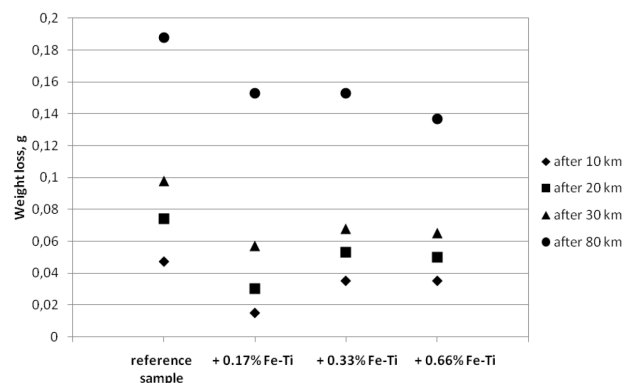

Fig. 5. The result of wear resistance of the samples – reference sample, and inoculated by: 0.17%Fe-Ti, 0.33%Fe-Ti and 0.66%Fe-Ti

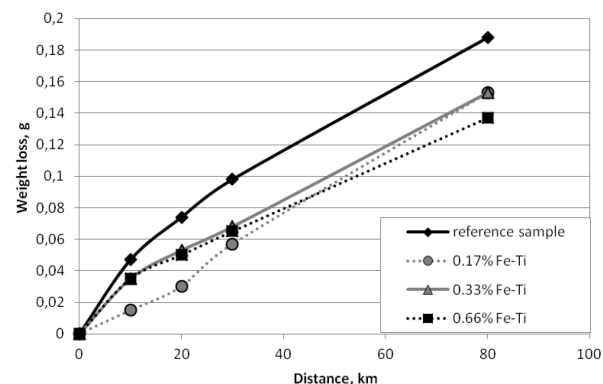

Fig. 6. The results of wear resistance as a function of distance

The experimental results indicate that inoculation improves the wear resistance. In the first phase, the best influence on wear resistance had the addition of 0.17%Fe-Ti. However, after the whole test, the best results were achieved for inoculation by 0.66%Fe-Ti. This is important information about the methodology for performing wear resistance tests. If the test was completed over a distance of 30 km, the results would indicate that the best results were obtained for the 0.17%Fe-Ti inoculation, but it turned out that for the longest usage time the best inoculer is 0.66%Fe-Ti.

### 3.2. Microstructure analysis

The microstructure analysis were performed to find out if there is correlation between wear resistance and microstructure. Fig.7 presents obtained microstructures.

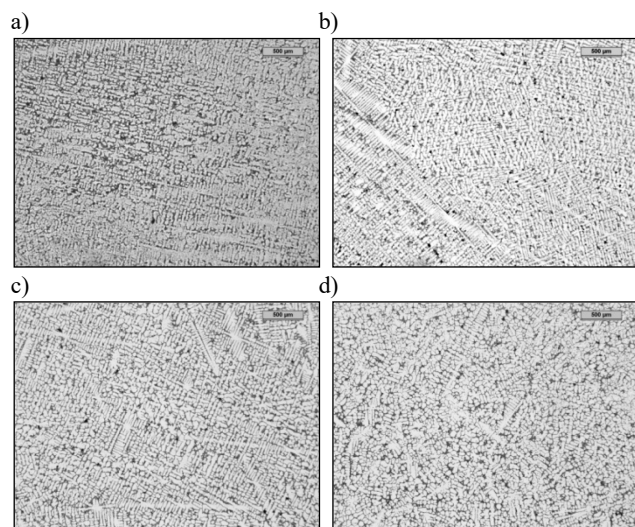

Fig. 7. The microstructure analysis for reference sample with white cast iron - a) and after inoculated: 0.17%Fe-Ti - b), 0.33%Fe-Ti - c) and 0.66%Fe-Ti - d)

From the Fig.7 it can be found that the improvement in wear resistance is achieved by changing in microstructure. With the biggest addition of titanium the microstructure is finer. The dendrites are not growing in one direction, there are more equiaxed grains.

### 4. Conclusions

The present work, aimed at studying the influence of titanium inoculation on tribological properties of High Chromium Cast Iron, led to the following conclusions:

1. Inoculation improves the wear resistance. In every sample after inoculation the wear resistance was at least 20% higher than the reference sample.
2. In the first phase the best result was obtained for sample inoculated by 0.17%Fe-Ti. However after conducting whole test the smallest weight loss had the sample inoculated by 0.66%Fe-Ti. Due to the application of High Chromium Cast Iron, it is essential that the material is characterized by the best wear resistance for the longest usage time.
3. This property is correlate with the changing in microstructure. With greater amount of titanium the microstructure is finer. More fine carbides do not crumbling so quickly from the matrix, improving the wear resistance.

### Acknowledgements

The study was co-financed by NCBiR as a targeted project No. PBS/B5/44/2015 and as a part of the PhD thesis MSc. Dorota Siekaniec.

### References

- [1] Qiang Liu (2012). *Control of Wear-Resistant Properties in Ti-added Hypereutectic High Chromium Cast Iron*. Department of Materials Science and Engineering Royal Institute of Technology, Stockholm, Sweden.
- [2] Baotong Lu, Jingli Luo, Stefano Chiovelli (2006) Corrosion and Wear Resistance of Chrome White Irons—A Correlation to Their Composition and Microstructure. *Metallurgical and Materials Transactions A*. vol. 37A, 3029-3038.
- [3] Chung, R.J., Tanga, X. Li, D.Y., Hinckley, B. & Dolman, K. (2009). Effects of titanium addition on microstructure and wear resistance of hypereutectic high chromium cast iron Fe-25wt.%Cr-4wt.%C. *Wear*. 267, 356-361.
- [4] Studnicki, A., Dojka, R., Gromczyk, M. & Kondracki, M. (2016). Influence of Titanium on Crystallization and Wear Resistance of High Chromium Cast Iron. *Archives of Foundry Engineering*. 16(1), 117-123.
- [5] Kopyciński, D., Guzik, E., Siekaniec, D. & Szczęsny A. (2015). The effect of addition of titanium on the structure and properties of High Chromium Cast Iron *Archives of Foundry Engineering*. 15(3), 35-38.
- [6] Studnicki, A. (2013). *Role of selected inoculants in crystallization of wear resistant high chromium cast iron*. Monography. Katowice-Gliwice: Archives of Foundry Engineering. (in Polish).
- [7] Kopyciński, D., Siekaniec, D., Szczęsny, A. Nowak, A. & Sokolnicki, M. (2016). The Althoff-Radtke test adapted for high chromium cast iron *Archives of Foundry Engineering*. 16(4), 61-64.
- [8] Zumelzu, E., Goyos, I., Cabezas, C., Opitz, O. & Parada, A. (2002). Wear and corrosion behavior of high-chromium (14–30% Cr) cast iron alloys. *Journal of Materials Processing Technology*. 128, 250-255.
- [9] Wang, Y.P., Li, D.Y., Parent, L. & Tian, H. (2011). Improving the wear resistance of white cast iron using a new concept –High-entropy microstructure. *Wear*. 271, 1623-1628.
- [10] Bedolla-Jacuinde, A., Correa, R., Mejía, I., Quezada, J.G. & Rainforth, W.M. (2007). The effect of titanium on the wear behavior of a 16%Cr white cast iron under pure sliding. *Wear*. 263, 808-820.