

# Application of in-line rheological measurements for characterization of polypropylene/opoka rock powder composites

Arkadiusz Kloziński<sup>1),\*)</sup>, Paulina Jakubowska<sup>1)</sup>, Joanna E. Przybylska<sup>1)</sup>, Robert Przekop<sup>2)</sup>

DOI: [dx.doi.org/10.14314/polimery.2019.4.6](https://doi.org/10.14314/polimery.2019.4.6)

**Abstract:** The rheological properties of the composites of polypropylene (PP) with a new natural powder hybrid filler – carbonate-silicate rock called opoka – were investigated. Opoka rock is industrial waste originating (as a subsieve fraction) from the production of sorbents used in water treatment processes. The effect of opoka addition (1, 5 and 10 wt %) on the processability of PP was determined during the extrusion process using an in-line measuring stand. The testing instrument was an extruder rheometer equipped with a rheological measuring head with exchangeable dies. Cylindrical measuring dies with a radius of 1.5 mm and a length of  $L = 20, 30, 40$  and  $50$  mm, respectively, were used in the measurements. The rheological parameters of the composites were determined based on the Ostwald-de-Waele power-law model at a temperature of  $230$  °C. The effect of the addition of opoka on the extruder operating characteristic, flow curves, viscosity curves, and the values of power law index ( $n$ ), consistency factor ( $K$ ), mass flow rate ( $MFR$ ) and volume flow rate ( $MVR$ ) have been determined.

**Keywords:** polypropylene, polymer composites, opoka, powder filler, natural filler, hybrid filler, in-line rheology, viscosity, viscosity curve.

## Zastosowanie pomiarów reologicznych typu *in-line* w charakterystyce kompozytów polipropylenu ze skałą opoka jako napełniaczem proszkowym

**Streszczenie:** Badano właściwości reologicznych kompozytów polipropylenu (PP) z nowym, naturalnym, proszkowym napełniaczem hybrydowym – skałą węglanowo-krzemionkową zwaną opoką, stanowiącą odpad przemysłowy powstający podczas produkcji sorbentów (frakcja podsitowa), stosowanych w procesach oczyszczania wody. Wpływ dodatku opoki (1, 5 i 10 % mas.) na przetwarzalność PP określano na stanowisku pomiarowym typu *in-line* w procesie wytłaczania. Urządzenie badawcze stanowił reometr wytłaczarkowy z reologiczną głowicą pomiarową z wymiennymi dyszami. W pomiarach zastosowano cylindryczne dysze pomiarowe o promieniu  $R = 1,5$  mm i długości  $L = 20, 30, 40$  i  $50$  mm. Parametry reologiczne kompozytów wyznaczano na podstawie modelu potęgowego Ostwalda-de-Waele w temp.  $230$  °C. Określano wpływ dodatku opoki na charakterystykę pracy wytłaczarki, przebieg krzywej płynięcia oraz krzywej lepkości, a także wartości wykładnika płynięcia ( $n$ ), współczynnika konsystencji ( $K$ ), masowego wskaźnika szybkości płynięcia ( $MFR$ ) oraz objętościowego wskaźnika szybkości płynięcia ( $MVR$ ).

**Słowa kluczowe:** polipropylen, kompozyty polimerowe, opoka, napełniacz proszkowy, napełniacz naturalny, napełniacz hybrydowy, reologia *in-line*, lepkość, krzywa lepkości.

Presently, the most common method of introducing fillers to the polymeric matrix, or producing polymer composites, is their mixing with a molten polymer, *i.e.*,

<sup>1)</sup> Poznan University of Technology, Institute of Chemical Technology and Engineering, Berdychowo 4, 60-965 Poznań, Poland.

<sup>2)</sup> University of Adam Mickiewicz in Poznan, Center for Advanced Technology, Umultowska 89c, 61-614 Poznań, Poland.

\*) Author for correspondence:

e-mail: [Arkadiusz.Klozinski@put.poznan.pl](mailto:Arkadiusz.Klozinski@put.poznan.pl)

physical modification [1, 2]. The process of homogenization of a polymer with a filler can be conducted using batch mixers, rolling mills and extruders, as described in publications [3, 4]. The purpose of the filler is to enhance the specific properties of the polymer. The filler can be of either natural or synthetic origin and may have a different form [1, 2]. Nowadays many researches are also being conducted into the production and application of multi-component, and thereby multifunctional, fillers (that modify more than one property), so-called hybrid fillers [5–7]. Examples of this type of fillers are systems con-

taining polyhedral oligomeric silsesquioxanes (POSS), such as POSS/silica [5], POSS/lignin [6], POSS/MgO-SiO<sub>2</sub> [7], or the system phosphorylated cashew nut shell liquid prepolymer (PCNSL)/kaolin [8]. A hybrid filler, *e.g.*, POSS/silica, not only constitutes a modern multifunctional system, but also allows an expensive filler (a POSS-type nanofiller) to be introduced to the polymer matrix by applying it onto the surface of an inexpensive and readily available carrier, which is silica. In the case of this type of hybrid fillers, this may provide an advantageous economic benefit [5].

Powder hybrid fillers of natural origin, which might find potential application as polymer modifiers, include opoka rock. Opoka is a sedimentary rock that is intermediate between carbonate and silicate rocks. It originates from the Cretaceous period, mainly from its early part, the so-called upper Cretaceous age. The content of silica (SiO<sub>2</sub>) in opoka rock ranges from 5 to 75 wt % and it occurs predominantly in the form of opal, chalcedony or quartz [9–12]. Depending on their calcium content (as converted to CaO) or silicon content, opokas can be divided into heavy opokas, where carbonate contents predominate, and light opokas, also known as decalcified opokas, with silica predominating in their composition [9, 10]. The division of opokas in terms of their calcium and silicon contents is provided in work [9]. Carbonate-silicate rocks differ in properties and composition, depending on the period of their formation, which is reflected also in their variations resulting from the place of their occurrence [9, 12]. In addition to silica and calcium, opoka can also include: MgO, Al<sub>2</sub>O<sub>3</sub>, Fe<sub>2</sub>O<sub>3</sub>, K<sub>2</sub>O, Na<sub>2</sub>O, TiO<sub>2</sub>, P<sub>2</sub>O<sub>5</sub>, MnO<sub>2</sub> [13]. However, the quantitative and qualitative compositions of opoka may vary, depending on its origin [13, 14]. Owing to their thermal and mechanical properties, opokas find application in the building industry, cement production, road construction, river revetment, and the manufacture of decorative lining and ceramic materials [10–12, 15]. The sorption properties of opokas are utilized in the processes of water and sewage purification to remove phosphorus, magnesium and iron, among others [10, 16].

In its chemical composition, opoka has two compounds from among the most common powder fillers of polymers, including polypropylene (PP), namely calcium carbonate (CaCO<sub>3</sub>) and silica. The addition of calcium carbonate improves the thermal stability and impact strength, and enhances the mechanical parameters in bending (strength, the module) of polypropylene-matrix composites [17–19]. The modification of polypropylene by adding silica improves also its temperature stability [20]. The silica addition reinforces polypropylene composites to be subjected to loading under static tension conditions [21]. Therefore, it can be presumed that the addition of opoka, which contains CaCO<sub>3</sub> and SiO<sub>2</sub> in its structure, may bring about the advantageous effect of improving the aforementioned properties of the filled polymer.

Each addition of a filler to a polymer is accompanied by a change in its rheological properties. In the majority of instances, the processability of composites impairs with increasing filler content of the polymer [22–26]. For calcium carbonate, in the case of its small additions (up to 10 wt %) or the use of compatibilizers (such as calcium stearate and calcium carbonate), no effect of the filler on the polymer viscosity or its reduction can be observed [27, 28]. The addition of SiO<sub>2</sub>, either as nano- or microsili- ca, results in an increase in the viscosity of polymer, and thus an impairment of its processability. To determine the potential for using opoka as a thermoplastic polymer filler it is necessary to assess the effect of its addition on the composite viscosity and the possibility of using it in composites processing. Such analysis can be made by carrying out in-line rheological measurements [22, 25, 29]. In these measurements, the function of a rheometer is performed by a specially designed extrusion head [22, 25, 30] or injection mold [31], making up the equipment of the processing machine. In-line measurements make it possible to determine the rheological properties of polymeric materials under real technological conditions and the effect of process setting parameters on their processability. Besides, they provide information on the influence of the filler addition on the characteristic of extruder operation – the efficiency of extrusion and changes in flow resistance occurring in it [22, 30]. Such research capabilities provide a source of practical engineering information that is particularly important when attempting to use new types of fillers for polymer modification.

Therefore, an attempt has been made in this study to make the assessment of the effect of the addition of a natural powder hybrid filler, which is opoka rock, on the rheological properties of commercial polypropylene. Measurements were taken using an in-line extruder rheometer for PP composites having a low fill degree, *i.e.*, 1, 5 and 10 wt % of opoka.

## EXPERIMENTAL PART

### Materials

Commercial isotactic polypropylene (PP) Moplen HP456J delivered by Basell Orlen Polyolefins (Poland), with a density of  $d = 0.893 \pm 0.001$  g/cm<sup>3</sup>, and melt flow rate  $MFR_{(230\text{ }^{\circ}\text{C}, 2.16\text{ kg})} = 3.18 \pm 0.01$  g/10 min, was used as the test material. The used polymer is dedicated for the manufacture of monofilaments, ropes and tapes.

Carbonate-silicate rock, called opoka, taken at Bełżec, a town in South-Eastern Poland, was used as a filler. The opoka used for testing is a production waste (subsieve fraction) formed during the manufacture of sorbent used for clearing water of phosphates (water pollution). In the sorbent production process, the opoka was subjected to calcination at 1000 °C. The effect of the calcination process on the chemical composition of the opoka used in the tests is described in detail in study [13]. Unsieved pro-

duction waste with an average grain size of  $d_{50} = 117.0 \mu\text{m}$  and a specific surface area of  $A_{\text{BET}} = 9.0 \text{ m}^2/\text{g}$  was used for filling PP. The filler used form a mixture of inorganic compounds [13], of which silica (52.0 wt %) and calcium carbonate (46.6 wt %) constitute the largest share. It can therefore be presumed that these compounds can have the greatest effect on the rheological properties of polypropylene, and each of them may result in obtaining different functional properties of produced composites. This means that a similar effect as for the modification of polymers using synthetic hybrid fillers can be achieved [5–8]. So far, no studies have been carried out to assess the effect of the addition of a multicomponent filler of natural origin, such as opoka rock, on the processability of thermoplastic polymers.

### Modification process

The modification of the PP was made in a cold granulation extrusion process. A twin-screw extruder, model EH16.2D, by Zamak Mercator, with a screw diameter of  $D = 16 \text{ mm}$  and an  $L/D$  ratio of 40 was employed. Composites of polypropylene with opoka rock containing 1, 5, and 10 wt % of the filler, respectively, were produced, which will be denoted later in this paper as: OP1, OP5 and OP10.

### Methods of testing

#### Density

The density of polypropylene and composites was determined with an AXIS analytical balance with the hydro adapter, model AD200, at a measuring accuracy of  $0.001 \text{ g/cm}^3$ .

#### Rheological properties

The assessment of the rheological properties of the polypropylene and composites was made with the use of an in-line measuring stand. The function of a rheometer was performed by a Mc ARKON REPIQUET single-screw extruder, model Fairex, with a screw diameter of  $D = 25 \text{ mm}$  and an  $L/D$  ratio of 24. The extruder was equipped with the author's rheological measuring head with exchangeable dies (Fig. 1), having a pressure sensor and a thermocouple (for polymer pressure and temperature measurements). The rheological extrusion experiments were performed at a temperature of  $230 \text{ }^\circ\text{C}$  (melt polymer temperature) and screw speed ( $V_s$ ) in the range from 10 to 45 rpm. The extrusion head was equipped with exchangeable cylindrical dies with an entrance angle of  $45^\circ$ , radius  $R = 1.5 \text{ mm}$  and lengths  $L = 20, 30, 40$  and  $50 \text{ mm}$ . Measurements by using dies with an identical radius, but different lengths, enabled the determination of the Bagley correction ( $e_B$ ) (see Eq. 2).

For each examined polymer material in the tests, the characterization of the extrusion process was made,

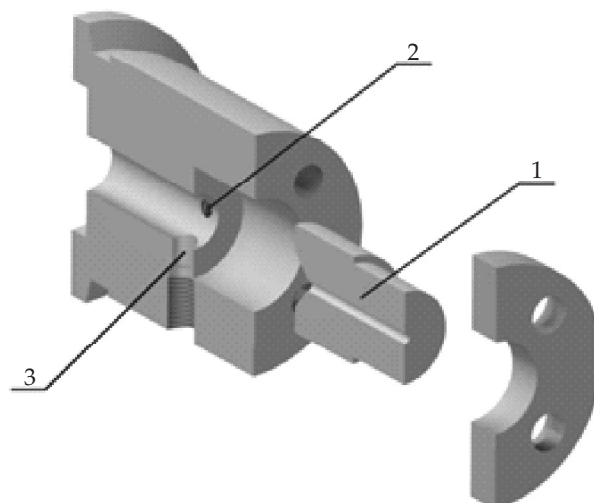

Fig. 1. Rheological extrusion head: 1 – exchangeable cylindrical die, 2 – thermocouple, 3 – pressure sensor

which included the determination of the relationship between the screw speed, total pressure drop [ $\Delta p = f(V_s)$ ] and volumetric flow rate [ $\dot{Q} = f(V_s)$ ]. The value of  $\dot{Q}$  was determined based on the mass flow rate ( $\dot{M}$ ), allowing for the changes in polymer and composite densities under given processing conditions ( $\rho_{p, v}$ ), as determined from the  $pVT$  diagrams ( $pVT$  100 SWO instrument, Germany). The importance of density changes in in-line rheological measurements is highlighted in a previous publication [32].

From the volumetric flow rate and total pressure drop, the variations in flow curves and viscosity curves during the flow of polymeric materials through the die of a specific length were determined. The shear stress ( $\tau_w$ ) at the wall of the capillary was calculated using the expression:

$$\tau_w = \frac{\Delta p \cdot R}{2L} \text{ (Pa)} \quad (1)$$

where:  $\Delta p$  – total pressure drop across the capillary die,  $R$  – radius of the die, and  $L$  – length of the die.

The magnitude of shear stress was corrected with the Bagley correction allowing for pressure losses in the die entrance [33]. The measurement and calculation procedure for determining  $e_B$  in in-line rheological measurements are described in detail in a previous publication [34]. Equation (1) assumes then the following form [33, 34]:

$$\tau_B = \frac{\Delta p \cdot R}{2(L + e_B R)} \text{ (Pa)} \quad (2)$$

where:  $e_B$  – Bagley correction.

The apparent shear rate ( $\dot{\gamma}_a$ ) at the wall was evaluated using the equation:

$$\dot{\gamma}_a = \frac{4 \cdot \dot{Q}}{\pi \cdot R^3} \text{ (s}^{-1}\text{)} \quad (3)$$

where:  $\dot{Q}$  – volumetric flow rate.

The calculation of shear viscosity started from a plot of the shear stress ( $\tau_w$ ) versus the apparent shear ratio ( $\dot{\gamma}_a$ ) on

a double logarithm scale. When apparent flow curve plotted in double logarithmic scaling gives straight line, it is an indication that Ostwald-de-Waele equation can be safely used [35]:

$$\tau_w = K \cdot \dot{\gamma}_a^n \quad (4)$$

where:  $K$  – consistency or viscosity coefficient index,  $n$  – power law index.

The true shear rate was obtained by applying the Rabinowitsch correction [33, 36]:

$$\dot{\gamma}_w = \frac{4 \cdot \dot{Q}}{\pi \cdot R^3} \cdot \left( \frac{3n+1}{4n} \right) \quad (5)$$

The true shear viscosity was therefore calculated as follows:

$$\eta_w = \frac{\tau_w}{\dot{\gamma}_w} \quad (\text{Pa} \cdot \text{s}) \quad (6)$$

#### Mass flow rate and volume flow rate

The effect of the opoka addition on the mass flow rate ( $MFR$ ) and volume flow rate ( $MVR$ ) was also determined. The measurements were taken using a Dynisco plastometer, model LMI 4004, according to the applicable standard ISO 1133. The measurement temperature was  $230 \pm 0.5$  °C, while the piston loading 2.16 kg.

## RESULTS AND DISCUSSION

The addition of opoka caused, in a natural manner, an increase in polypropylene density. The density of polymeric materials was determined in ambient conditions ( $d_{23}$ ) using a hydrostatic balance and at a temperature of 230 °C ( $d_{230}$ ) – using a dead-weight plastometer (method A/B complying with standard ISO 1133). The values of the density of composites, as determined under the accepted measurement conditions, are summarized in Table 1. The density determined at a temperature of 230 °C with a plastometer piston load of 2.16 kg was used for calculating the  $MVR$ .

The determination of the effect of opoka addition on the processability of polypropylene was started with the assessment of variations in the mass flow and volume flow rate, which are a technical measure of polymer processability. Figure 2 summarizes variations in  $MFR$  and  $MVR$  values as a function of the filler content of polypropylene

composites. The value of mass flow rate increases with increasing filler content of polymer. The  $MFR$  of pure polymer is  $3.18 \pm 0.01$  g/10 min. The effect of the filler addition on the mass flow rate is the most prominent for an opoka concentration of 10 wt % – in this case, the  $MFR$  value is  $3.47 \pm 0.01$  g/10 min. As shown by the behavior of the curve determined for volumetric flow rate ( $MVR$ ) (Fig. 2), the opoka addition does not significantly influence the  $MVR$  value. A slight increasing tendency can be noticed. For PP, the  $MVR$  value was  $4.22 \pm 0.01$  cm<sup>3</sup>/10 min. The addition of 10 wt % filler caused an increase in  $MVR$  of up to a level of  $4.28 \pm 0.01$  cm<sup>3</sup>/10 min. It can be found from the analysis of the mass and volumetric flow rates that opoka, as a filler (in the concentration range under consideration) does not impair the processability of the polymer. This reveals a high application potential of the filler from the point of view of its processing. The obtained variations in  $MFR$  and  $MVR$  as a function of opoka content show that in order to objectively determine the effect of filler addition on the processability of polymer, a comprehensive analysis of flow rates ( $MFR$  and  $MVR$ ) is required.

To characterize the extruder operation, the curves of the relationship of the total pressure drop versus extruder screw speed,  $\Delta p = f(V_s)$ , were determined for each of the employed measuring dies. When examining the variations in  $\Delta p$  as a function of measuring die length,  $L$ , a natural increase in flow resistance ( $\Delta p \uparrow$ ) with increasing die length was found [22]. The lowest flow resistance occurred during flow through a die with a length of  $L = 20$  mm, while the highest flow resistance during flow through a die with a length of  $L = 50$  mm – irrespective of the type of polymeric material examined. The behavior of

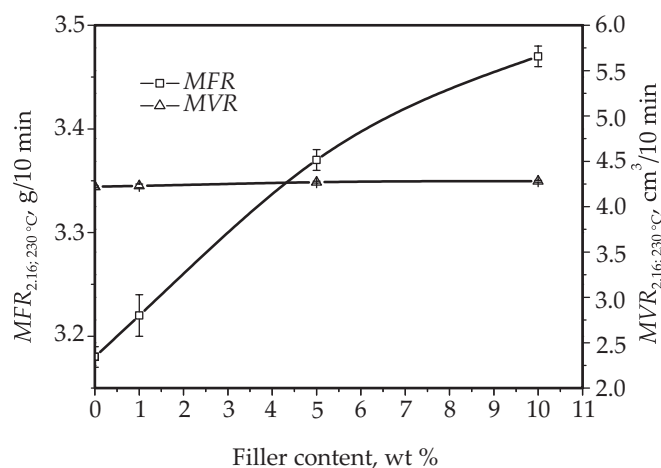

Fig. 2. Dependence of  $MFR$  and  $MVR$  as a function of filler (opoka rock) content

Table 1. Dependence of density of polypropylene composites on opoka filler content

Density g/cm <sup>3</sup>	Designation of sample			
	PP	OP1	OP5	OP10
$d_{23}$	$0.893 \pm 0.001$	$0.903 \pm 0.001$	$0.925 \pm 0.001$	$0.953 \pm 0.002$
$d_{230}$	$0.754 \pm 0.001$	$0.765 \pm 0.002$	$0.789 \pm 0.002$	$0.811 \pm 0.002$

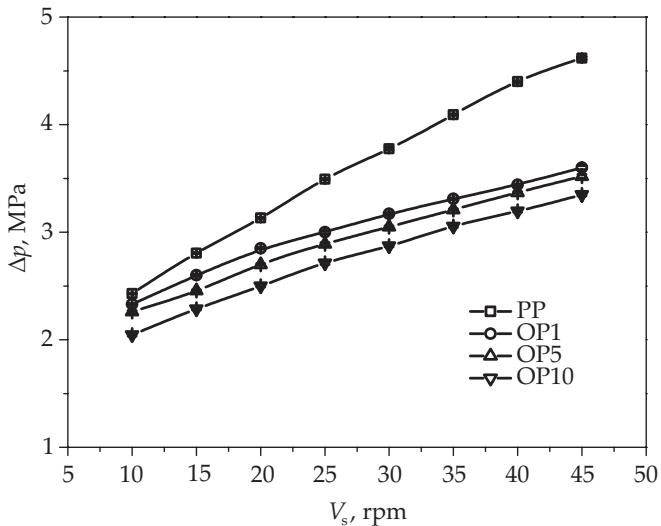

Fig. 3. Total pressure drop ( $\Delta p$ ) versus screw speed ( $V_s$ ) for PP and its composites (OP1, OP5 and OP10), die  $L = 20$  mm

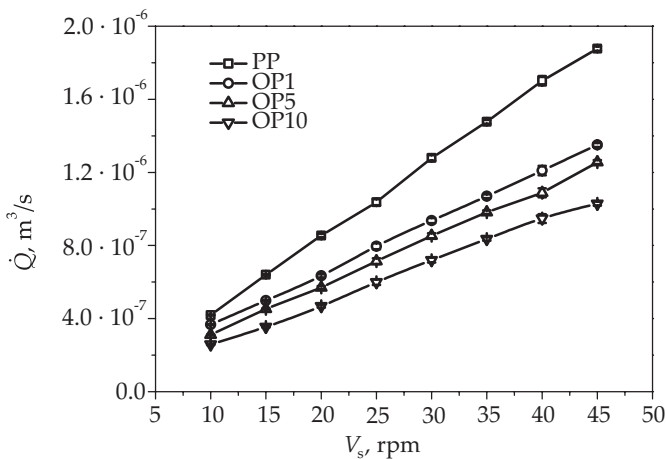

Fig. 4. Volume flow rate ( $\dot{Q}$ ) versus screw speed ( $V_s$ ) for PP and its composites (OP1, OP5 and OP10), die  $L = 30$  mm

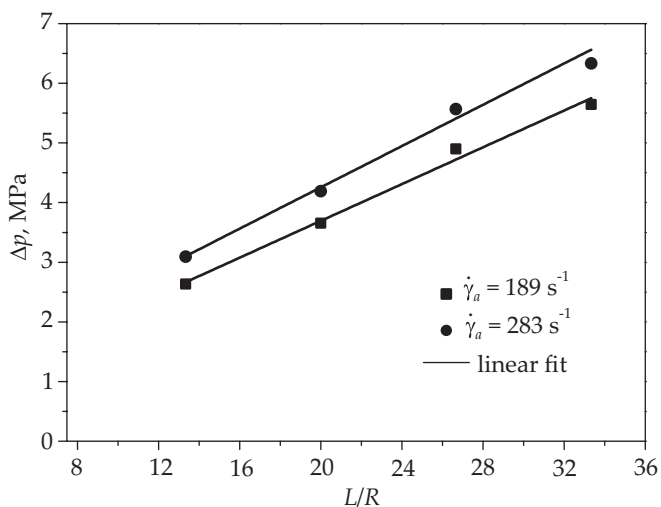

Fig. 5. Bagley plot – total pressure drop ( $\Delta p$ ) versus  $L/R$  for composite OP10 ( $\dot{\gamma}_a = 189$  and  $283 \text{ s}^{-1}$ )

the  $\Delta p = f(V_s)$  curves showed also an effect of opoka on the flow resistance. The magnitude of the total pressure drop decreased with the increase in the powder hybrid filler

content of the polymer matrix, which can be regarded as a positive aspect of using opoka as a filler. A confirmation of these observations is the illustration of  $\Delta p$  variations as a function of  $V_s$  determined during the flow of PP and composites (OP1, OP5 and OP10) through a die with a length of  $L = 20$  mm (Fig. 3).

No effect of employed measuring die length on the volumetric flow rate was observed as a function of extruder screw rotational speed. However, an effect of the opoka addition on the efficiency of the extrusion process was found. The magnitude of volumetric flow rate decreased with increasing polypropylene filler content. As can be seen from the curves  $\dot{Q} = f(V_s)$  (Fig. 4), the highest volumetric flow rate has been obtained for PP, while the lowest for a composite containing 10 wt % filler (OP10). The relationship presented above applies to flow through a die of a length of  $L = 30$  mm; similar shifts of the curves were obtained for the flows determined for the remaining measuring dies.

The aim of using of dies of an identical radius and different lengths in the measurements was to determine the Bagley correction that makes allowance for pressure losses in the die entrance. For each of the materials, so-called Bagley graphs, representing the variation of pressure as a function of die length-to-diameter ratio [ $\Delta p = f(L/R)$ ], were plotted for some constant shear rate values. The value of  $e_B$  were read out from the point of intersection with the  $x$  axis [34]. Figure 5 shows an example of Bagley graph determined for composite OP5 for two selected shear rates, *i.e.*, 189 and 283  $\text{s}^{-1}$ .

Table 2 summarizes Bagley correction and shear rate values, for which the  $e_B$  was determined. Due to large differences in the characteristic  $\Delta p = f(\dot{Q})$  of the examined polymeric materials, the set constant measuring range of the apparent shear rate was contained in a fairly narrow interval, namely from 189 to 283  $\text{s}^{-1}$ . As shown by the data included in the table, the Bagley correction value increases in a natural manner with the increase in shear rate. This is the effect of the increase in pressure existing in the die entrance region as a consequence of a higher volumetric flow rate [34]. The variations in  $e_B$  are also influenced by the filler content of the polymer. The greater values of the Bagley correction indicate increasing pressure losses in the die entrance. When comparing the  $e_B$  for the polypropylene and the produced composites, a correction increase, relative to the polymer matrix, is visible, as a result of the opoka addition. The largest Bagley correction values with respect to PP occur for composite OP1, and then they decrease with increasing filler content. The performed analysis shows that a composite of the best processability, considering disturbing entrance effects, is the composite containing 10 wt % filler.

A complete analysis of the rheological properties under the conditions of the shear flow of PP and composites was made for a die of a length  $L = 40$  mm. The determined values of  $\Delta p$  and  $\dot{Q}$  enabled the determination of the shear stress (Eqs. 1 and 2) and the apparent shear

**Table 2.** Values of Bagley correction of polypropylene and its composites

$\dot{\gamma}_a, \text{ s}^{-1}$	PP	OP1	OP5	OP10
	$e_B$			
189	2.41	3.69	3.24	2.84
220	2.48	3.79	3.40	3.13
252	2.55	3.88	3.55	3.39
283	2.61	3.96	3.69	3.62

rate (Eq. 3) at the wall of the die used (for  $R = 1.5$  mm). By using the Ostwald-de-Waele power-law model, the flow curves were determined, from which the values of power law index  $n$  and consistency factor  $K$  were determined. The flow curves were plotted to the corrected values of shear stress ( $\tau_B$ ), because the determined Bagley correction values had brought about quite significant shifts in the shapes of the flow curves [ $\tau = f(\dot{\gamma}_a)$ ]. This indicates the occurrence of significant pressure losses in the die entrance section under the adopted in-line measurement conditions. Figure 6 illustrates differences in behavior between the flow curve with no allowance for the Bagley correction [ $\tau_w = f(\dot{\gamma}_a)$ ] and the flow curve allowing for  $e_B$  [ $\tau_B = f(\dot{\gamma}_a)$ ] for composite OP1 during flow through a die with  $L = 40$  mm. Introducing a Bagley correction causes a flow curve to shift towards smaller  $\tau$  values. As a consequence, this entails also a shift of viscosity curves in the direction of smaller  $\eta$  values. From the flow curves, the values of power law index  $n$  and consistency factor  $K$  were determined. A summary of the values of power law equation constants is provided in Table 3.

As shown by the results shown in Table 3, the values of consistency factor grew with the increase in the filler content of the polymer matrix. The addition of the powder hybrid filler was reflected also in variations in the values of polypropylene power law index. In spite of the filler addition, the value of PP power law index stays in the range of values characteristic of thermoplastic poly-

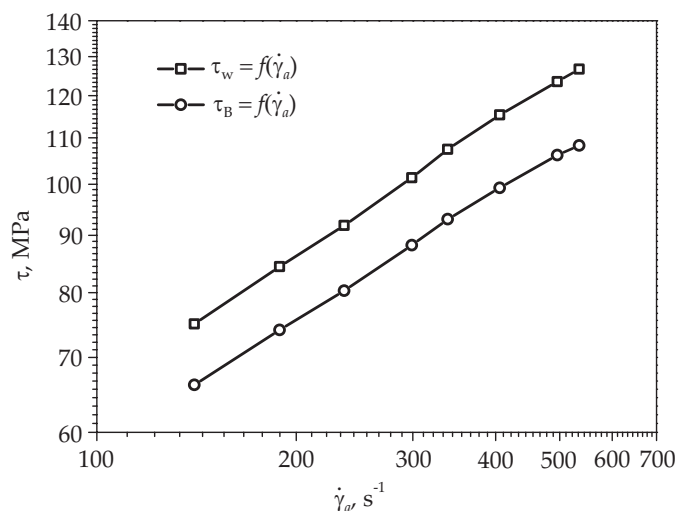
**Fig. 6.** Shear stress ( $\tau$ ) versus apparent shear rate ( $\dot{\gamma}_a$ ) for composite OP1, die  $L = 40$  mm ( $\tau_w$  – uncorrected shear stress,  $\tau_B$  – corrected shear stress)**Table 3.** Power law constants for composites of polypropylene with opoka rock filler determined in in-line measurements (die:  $L = 40$  mm)

Power law constants	PP	OP1	OP5	OP10
$n$	0.354	0.348	0.285	0.250
$K, \text{ Pa} \cdot \text{ s}^n$	13 224	15 999	18 877	22 426

mers [22, 33]. For PP filled with opoka a relationship specific to thermoplastic polymers is observed – the value of power law index for these composites decreases with increasing filler contents of the matrix, thus enhancing their pseudo-plastic behavior [26, 30].

The determination of the power law index value allowed to make a correction to the apparent shear rate (Rabinowitsch correction) and to determine the true viscosity curves for the composites under examination [22, 33, 36]. The addition of the powder hybrid filler in the amount from 1 to 10 wt % did not cause any significant changes in the true viscosity of polypropylene. Figure 7 juxtaposes the  $\eta_w = f(\dot{\gamma}_w)$  curves determined for PP and its composites, respectively, during the flow through a die of a length of  $L = 40$  mm. A slight shift in the viscosity curves for the composites towards smaller  $\eta$  values, compared to the pure polypropylene, is visible – especially in a larger shear rate range. The presented viscosity curves of composites overlap, which confirms the lack of a distinct effect of opoka on the polymer viscosity. As can be seen from the viscosity curves, the increase in viscous flow resistance is insufficient for the rheological nature of the examined materials to change – the fluids being shear thinned.

## CONCLUSIONS

The investigation of the rheological properties of polypropylene composites with a new powder hybrid filler of natural origin, presented in this article, has shown

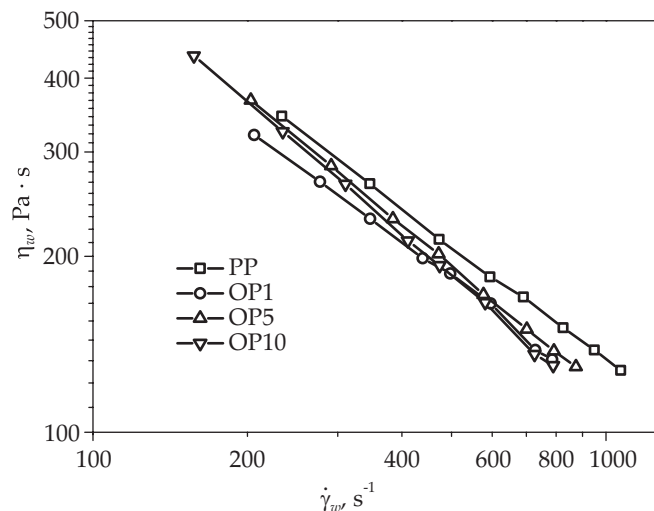
**Fig. 7.** Shear viscosity ( $\eta_w$ ) versus true shear rate ( $\dot{\gamma}_w$ ) for PP and its composites (OP1, OP5 and OP10), die  $L = 40$  mm

a potential for using opoka as a polymer modifier. With its small addition (1 and 5 wt %), opoka does not change the *MFR* value of polypropylene. The addition of the filler in the amount of 10 wt % improves the polymer processability – an increase in the value of mass flow rate, compared to the polymer matrix is observed. The results of in-line measuring technique used for the assessment of the rheological properties of the innovative composites have confirmed the possibility of processing them by extrusion. The addition of opoka does not adversely affect the characteristic of the extrusion process – does not cause unstable operation of the extruder. The absence of significant differences in rheological properties between the composites and polypropylene is rather unexpected. In the majority of cases of the modification of polyolefins with powder fillers, an increase in material viscosity is observed. This is regarded as the greatest defect of material, which is caused by it being filled with powders. The presented investigation has demonstrated that the viscosity of the examined composites does not change significantly with increasing filler content. This may be caused by the presence of calcium carbonate in the composition of opoka. Research carried out into the use of small amounts of  $\text{CaCO}_3$  as a filler has shown that it may cause a drop in material viscosity [37, 38]. It may also be due to the presence of other components of opoka rock [13]. This could be clarified by rheological tests of polypropylene composites filled with opokas of varying composition and composites with a high fill degree, which is the subject of ongoing research work. In view of the above discussion, it can be concluded that opoka would find application as a powder filler to reduce the cost of polypropylene, as in the case under consideration it is production waste. It is also a material that enhances the functional properties of polypropylene, as will be shown in publications to come.

*This work was supported by the Research Projects of Poznan University of Technology (03/32/DSPB/0804).*

#### REFERENCES

- [1] Koszkul J.: „Materiały polimerowe”, Wydawnictwo Politechniki Częstochowskiej, Częstochowa 1999.
- [2] Żuchowska D.: „Polimery konstrukcyjne”, WNT, Warszawa 2000.
- [3] Hornsby P.R.: “Mineral Fillers in Thermoplastics I. Advances in Polymer Science” (Eds. Jancar J., Fekete E., Hornsby P.R., Jancar J., Pukánszky B., Rothon R.N.), vol. 139, p. 155, Springer, Berlin, Heidelberg 1999.  
[https://dx.doi.org/10.1007/3-540-69220-7\\_4](https://dx.doi.org/10.1007/3-540-69220-7_4)
- [4] Shenoy A.V.: “Rheology of Filled Polymer Systems”, Kluwer, Dordrecht 1999.
- [5] Szwarc-Rzepka K., Walkowiak M., Osińska-Broniarz M. et al.: *Polimery* **2013**, 58, 748.
- [6] Tomaszewska J., Kłapiszewski Ł., Skórczewska K. et al.: *Polimery* **2017**, 62, 19.  
<https://dx.doi.org/10.14314/polimery.2017.019>
- [7] Ambroźewicz D., Jakubowska P., Kloziński A. et al.: *Polish Journal of Chemical Technology* **2013**, 15, 42.
- [8] Sreelekshmi R.V., Sudha J.D., Ravindranatha Menon A.R.: *Polymer Bulletin* **2017**, 74, 783.  
<https://dx.doi.org/10.1007/s00289-016-1745-9>
- [9] Kozłowski S.: „Surowce skalne Polski”, Wydawnictwo Geologiczne, Warszawa 1986.
- [10] Bus A., Karczmarczyk A.: *Infrastruktura i ekologia terenów wiejskich*, Polska Akademia Nauk, Kraków **2014**, 2, 227.
- [11] Pinińska J.: *Górnictwo i Geoinżynieria* **2008**, 32, 293.
- [12] Bernat-Hunek D.: „Hydrofobizacja opoki wapińskiej w obiektach zabytkowych Kazimierza Dolnego”, Politechnika Lubelska, Lublin 2010.
- [13] Brogowski Z., Renman G.: *Polish Journal of Environmental Studies* **2004**, 13, 15.
- [14] Józwiakowski K., Gajewska M., Pytka A. et al.: *Ecological Engineering* **2017**, 98, 290.  
<http://dx.doi.org/10.1016/j.ecoleng.2016.11.006>
- [15] Kotlyar V.D., Lapunova K.A., Kozlow G.A.: *Procedia Engineering* **2016**, 150, 1452.  
<http://dx.doi.org/10.1016/j.proeng.2016.07.080>
- [16] Marzec M., Pieńko A., Gizińska-Górna M. et al.: *Journal of Water and Land Development* **2017**, 34, 197.  
<http://dx.doi.org/10.1515/jwld-2017-0054>
- [17] Li H.Y., Tan Y.Q., Zhan L. et al.: *Journal of Hazardous Materials* **2012**, 217–218, 256.  
<https://dx.doi.org/10.1016/j.jhazmat.2012.03.028>
- [18] Lin Z., Guan Z., Chen Ch. et al.: *Thermochimica Acta* **2013**, 551, 149.  
<https://dx.doi.org/10.1016/j.tca.2012.10.009>
- [19] Yao Z.T., Chen T., Li H.Y. et al.: *Journal of Hazardous Materials* **2013**, 262, 212.  
<https://dx.doi.org/10.1016/j.jhazmat.2013.08.062>
- [20] Srisawat N., Nithitanakul M., Srikulkit K.: *Journal of Metals, Materials and Minerals* **2009**, 19, 53.
- [21] Wu Ch.L., Zhang M.Q., Rong M.Z., Friedrich K.: *Composites Science and Technology* **2001**, 62, 1327.  
[https://doi.org/10.1016/S0266-3538\(02\)00079-9](https://doi.org/10.1016/S0266-3538(02)00079-9)
- [22] Kloziński A.: *Polimery* **2016**, 61, 788.  
<http://dx.doi.org/10.14314/polimery.2016.788>
- [23] Barczewski M., Lewandowski K., Schmidt M., Szostak M.: *Polymer Engineering and Science* **2017**, 57, 998.  
<https://dx.doi.org/10.1002/pen.24477>
- [24] Kloziński A., Jakubowska P.: *Polymer Engineering and Science* **2019**, 59, 155.  
<http://dx.doi.org/10.1002/pen.24894>
- [25] Mazzanti V., Mollica F.: *Journal of Polymers and the Environment* **2017**, 25, 1044.  
<http://dx.doi.org/10.1007/s10924-016-0876-2>
- [26] Steller R.T.: *Journal of Applied Polymer Science* **2005**, 97, 1401.  
<https://dx.doi.org/10.1002/app.21156>
- [27] Da Silva A.L.N., Rocha M.C.G., Moraes M.A.R. et al.: *Polymer Testing* **2002**, 21, 57.

- [28] Dantungee R., Yun J., Supaphol P.: *Polymer Testing* **2005**, 24, 2.  
<https://dx.doi.org/10.1016/j.polymeresting.2004.08.006>
- [29] Lewandowski K., Piszczek K., Zajchowski S., Mirowski J.: *Polymer Testing* **2016**, 51, 58.  
<http://dx.doi.org/10.1016/j.polymeresting.2016.02.004>
- [30] Kloziński A., Jakubowska P.: *Polymer Engineering and Science* **2018**.  
<http://dx.doi.org/10.1002/pen.24941>
- [31] Sykutera D., Wajer Ł., Kościuszko A. et al.: *Macromolecular Symposia* **2018**, 378, 1700056.  
<http://dx.doi.org/10.1002/masy.201700056>
- [32] Kloziński A., Sterzyński T., Samujło B.: *Polimery* **2009**, 54, 57.
- [33] Wilczyński K.: „Reologia w przetwórstwie tworzyw sztucznych”, Wydawnictwa Naukowo-Techniczne, Warszawa 2001.
- [34] Kloziński A., Sterzyński T.: *Polimery* **2005**, 50, 455.
- [35] Liang J.Z.: *Polymer Testing* **2002**, 21, 307.
- [36] Kloziński A., Sterzyński T.: *Polimery* **2007**, 52, 855.
- [37] Rocha M.C.G., Silva A.H.M.F.T., Coutinho F.M.B., Silva A.L.N.: *Polymer Testing* **2005**, 24, 1049.  
<http://dx.doi.org/10.1016/j.polymeresting.2005.05.008>
- [38] Wang Q., Sun X., Wu Z.: *Advances Materials Research* **2014**, 1053, 231.  
<http://dx.doi.org/10.4028/www.scientific.net/AMR.1053.231>

Received 18 VII 2018.

Zakład Tworzyw Sztucznych Politechniki Poznańskiej

serdecznie zaprasza do udziału

## w XXII Profesorskich Warsztatach Naukowych „Przetwórstwo Tworzyw Polimerowych”

Adamów, 30 czerwca – 2 lipca 2019 r.

Celem naukowym Warsztatów, które są kontynuacją i rozwinięciem spotkań zainicjowanych i organizowanych od 1980 r. przez prof. dr. hab. inż. Roberta Sikorę jest rozwój szkoły przetwórstwa tworzyw polimerowych, wskazywanie obszarów rozwoju i ekologicznych procesów polimerowych, a także prezentacja prowadzonych aktualnie prac badawczych.

### Tematyka:

- Nowe materiały polimerowe, napełniacze i środki pomocnicze
- Biodegradowalne materiały polimerowe z surowców odnawialnych
- Problemy przetwórstwa biodegradowalnych materiałów polimerowych
- Nowe rozwiązania w przetwórstwie tworzyw polimerowych
- Rozwój maszyn, narzędzi i oprzyrządowania technologicznego
- Nowe technologie wtórnego wykorzystania tworzyw
- Wymiana poglądów na bieżące problemy gospodarcze przetwórstwa tworzyw polimerowych
- Prezentacje rozpraw doktorskich i zakończonych przewodów habilitacyjnych

Wystąpienia są przewidywane w formie referatów i komunikatów wraz z dyskusją oraz podczas sesji posterowej.

Podobnie jak na poprzednich Profesorskich Warsztatach Naukowych przewiduje się możliwość publikowania wybranych prac w czasopiśmie „Polimery” oraz „Przetwórstwo Tworzyw”.

**Przewodniczący Warsztatów:** prof. dr. hab. inż. Tomasz Sterzyński, Politechnika Poznańska

### Komitet Organizacyjny:

**Sprawy merytoryczne:** dr. hab. inż. Joanna Ryszkowska, prof. PW (Politechnika Warszawska),  
dr. hab. inż. Aleksander Prociak, prof. PK (Politechnika Krakowska)

**Sprawy organizacyjne:** dr. inż. Monika Dobrzyńska-Mizera,  
dr. inż. Monika Knitter (Politechnika Poznańska)

**Miejsce konferencji:** Hotel Czarny Staw w Nowym Adamowie k. Aleksandrowa Łódzkiego.

<http://warsztatyprofesorskie2019.divisia.pl/>