

HYBRID ADAPTIVE BEAMFORMING APPROACH FOR ANTENNA ARRAY FED PARABOLIC REFLECTOR FOR C-BAND APPLICATIONS

Submitted: 5th September 2022; accepted: 29th September 2022

Sheetal Bawane, Debendra Kumar Panda

DOI: 10.14313/JAMRIS/1-2023/6

Abstract:

This paper presents the design of a parabolic reflector fed through a patch antenna array feed to enhance its directivity and radiation properties. Adaptive beam formers steer and alter an array's beam pattern to increase signal reception and minimize interference. Weight selection is a critical difficulty in achieving low SLL and beam width. Low Side Lobe Level [SLL] and narrow beam reduce antenna radiation and reception. Adjusting the weights reduces SLL and tilts the nulls. Adaptive beam formers are successful signal processors if their array output converges to the required signal. Smart antenna weights can be determined using any window function. Half Power Beam Width and SLL could be used to explore different algorithms. Both must be low for excellent smart antenna performance. In noisy settings, ACLMS and CLMS create narrow beams and side lobes. AANGD offers more control than CLMS and ACLMS. The blend of CLMS and ACLMS is more effective at signal convergence than CLMS and AANGD. It presents an alternative to the conventionally used horn-based feed network for C-band applications such as satellite communication. Broadside radiation patterns and 4x4 circular patch antenna arrays are used in the proposed design. 1400 aperture illumination is provided by the array's feed parabolic reflector, whose F/D ratio is 0.36. The proposed design's efficacy is assessed using simulation analysis.

Keywords: *microstrip patch, adaptive antennas, parabolic reflector, beamforming, antenna arrays, smart antenna.*

1. Introduction

Long-range signal transmission often makes use of reflector-equipped antennas in satellite communication. Feeding antenna and parabolic reflector must be calibrated to ensure the best possible performance in this combination. Material losses, efficiency, and separation between the feeder and reflector all have an impact on antenna performance and gain for a C-band satellite ground station. The wireless communication paradigm has completely transformed as a result of the rapid proliferation of cellular technology over the past decade. Enhancements to electrical circuits and gadgets have led to a rise in the ability to store, analyze, and transmit massive amounts of data. The size, cost, power, and speed of electronic systems have all taken

on new dimensions as a result of large-scale integration. All engineering fields have effectively exploited these benefits to achieve new levels of development and performance [1].

Long-distance communication systems, such as satellite communication, radar, and remote sensing, commonly use reflector-equipped antennas to achieve high gain and the required distances. With a reflector, a high gain antenna consumes less power, has low cross-polarization, low voltage standing wave ratio, lightweight carbon fiber material, and economical fabrication using cheap components [2]. An antenna with a reflector is ideal for transmitting and receiving signals at a satellite system's ground station. Spherical, hyperbolic, parabolic, and cylindrical reflectors are all options for use with a feeder antenna.

Horn antennas, log periodic dipole arrays, and spiral antennas are the most popular feeding antennas [3–5]. Most commonly, the horn antenna is used for long distance point-to-point transmission. Several advantages of microstrip antennas have led to their consideration as feed antennas. Because of their thin design and ease of use, they are well-suited for use in a wide range of electronic systems. It is also straightforward to achieve the appropriate beam shape and high gain by grouping them in an array [6].

In order to achieve high-speed wireless communication, high spectral efficiency, and large capacity, antenna design is a critical issue to resolve. The strong spectral features of the parabolic reflector antenna make it a crucial component in high-frequency transmission. Because of its parabolic shape, the antenna is able to produce a narrower radiation beam with greater signal precision. A point-to-point communication system could benefit greatly from having access to such features. The simplicity, high gain, and directivity of the parabolic reflector make it the best option for transmitting radio waves over the air. Because of their high directivity, horn antennas have long been utilized as the feed network for parabolic reflectors in demanding applications like satellite communication. Because of the size and weight of the necessary components, satellite communication has proven difficult. Electrical distribution to antenna components, on the other hand, has proven to be a major challenge for the team.

The intelligent adaptive antenna system made the most of a favorable situation to improve the performance of the antenna array by adjusting the power

distribution to the individual antenna elements. It is possible to steadily alter the antenna's mass characteristics to improve spectrum efficiency. An antenna array system's radiation pattern can be reshaped using the beamforming approach, which involves altering the weights in the spatial domain. Setting weights based on time ensures that the required signals are segregated from the interfering signal while maximizing the SNR and array output.

Microstrip array antenna feeder and parabolic reflector antennas are used in this work to study the ground station performance of a C band satellite system. The antenna in question is a 4x4 microstrip array antenna for C-band satellite applications. For example, theoretical calculations and simulations utilizing the reflector and a microstrip antenna determined the gain and directivity parameters of the antenna system. Material losses, efficiency, focal length, and other aspects must be taken into account in order to get the best results. In order to improve the adaptive beamforming technique's performance over the patch array feed, the antenna elements' power distribution was modified. The array feed reflector's mathematical structure represents the most significant contribution of the proposed design.

A Complex Valued Neural Network (CVNN) uses complicated input signals, threshold values, weights, and signal functions. Models are needed for signal processing. Complex-valued signals require specific complex-valued brain processing models. Complex neural models can process linearly complicated smart antenna signals. Smart antennas analyze signals from multiple sources and interferences to establish the array's principal beam direction. In this scenario, the signal's arrival direction must be determined. Side Lobe Level and Half Power Beam Width (HPBW) must be low to avoid interference (SLL).

CLMS and AANGD are complex-valued neural networks studied for use with Smart Antenna System signals. Widrow and Hoff's 1959 Least Mean Square (LMS) approach determines the gradient vector. This algorithm's iterative technique creates MMSE, however it can't handle complex data with noise. LMS's delayed convergence when Eigen values are widely dispersed depends on Eigen structure, according to a study. When covariance matrix Eigen values don't match, the LMS is data-dependent and takes a long time to stabilize. CLMS and ACLMS were used to handle complex data in a noise-free environment. CLMS outperforms ACLMS in signal convergence, but ACLMS outperforms it in HPBW and SLL applications. ACLMS outperformed HPBW and SLL in a noisy real-time setting with a short step size. Therefore, ACLMS is best for noisy environments and CLMS for calm ones.

The CLMS and ACLMS algorithms adapt HPBW and SLL. When value and N vary, the parameters change, making it hard to predict a value. AANGD adds two additional model parameters: initial nonlinearity and adaptive amplitude step size [1, 2]. To regulate HPBW and SLL, obtain the required values. Since each algorithm has advantages and disadvantages when

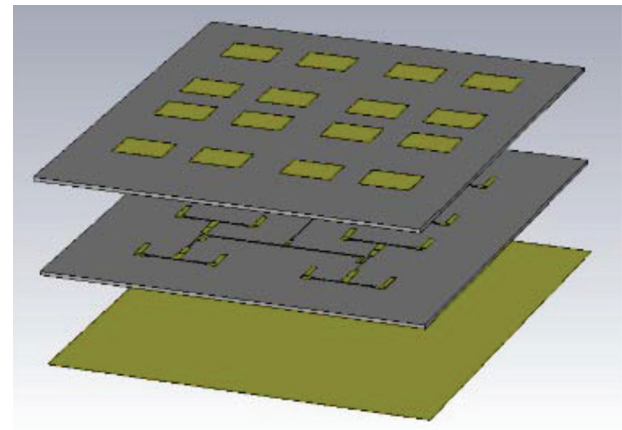

Figure 1. Patch antenna array feed 4x4 (top view)

it comes to the adaptive beam shaping of signals in Smart Antennas, CLMS and AANGD have been merged to create the Hybrid Model in this paper.

Here is how the rest of the essay is structured: In Section 2, the mathematical design of a patch antenna array and a parabolic reflector is covered. Section 3, an adaptive method based on a hybrid smart antenna is developed for use with a patch antenna array feed reflector. In Section 4, we present a simulation analysis of the proposed method to assess its viability, and in Section 5, we wrap up the paper.

2. System Preliminaries

2.1. Patch Antenna Array Feed

The horn antenna has long served as the primary source of power for the parabolic reflector it feeds. Due to the horn antenna's size and weight, deploying the feed network in applications requiring exact dimensioning is difficult. To tackle this problem, a patch antenna feed network may be able to balance illumination loss and spillover loss. The edge of the reflector dish is often reduced by 10 dB in order to achieve this trade-off. It is essential that the radiation pattern is on par with or better than standard feed networks, with a beamwidth of up to -10 dB. For C-band satellite applications, a 4x4 microstrip array antenna is discussed in this article [10]. Figure 1 shows the three layers of the 4x4 microstrip patch antenna's structure. 4x4 patches produce radiation from the top layer. Proximity coupling supplying the microstrip line is found in the middle layer. 'Ground plane,' as the name suggests, is the lowest stratum. The FR-4 substrate used in the antenna design has a permittivity 4.3 and 1.6 mm thick. Overall, the antenna is 170×170 mm. At 4.148 GHz and 734 MHz, the 4x4 microstrip array antenna's gain and bandwidth are 13.7 dB each, according to the antenna's characterization data. The top view of the 4x4 microstrip array antenna is shown in Figure 2. The patch configuration was deemed to be the optimum design for the desired requirements after parameterization. Figure 1 depicts the ideal setup.

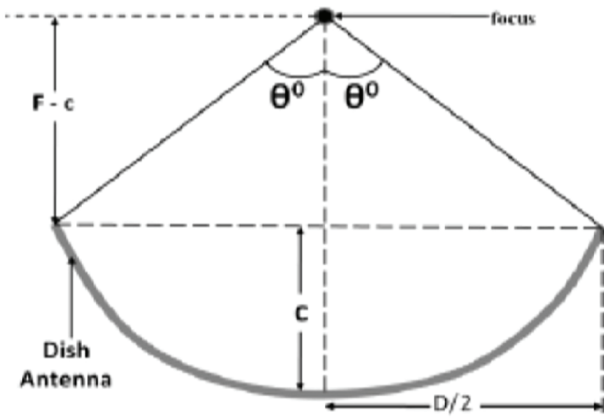

Figure 2. Basic geometry of parabolic antenna

2.2. Parabolic Reflector

In order to combine the two basic components, a feeder antenna is typically placed before a parabolic reflector. It is important to consider the reflector shape, reflector angle, and feed placement in relation to the reflector diameter (f/D ratio). To achieve high gain and low cross-polarization ratios, antenna radiation dispersion and projections on the reflector surface are critical. Using a parabolic reflector in front of a feed antenna is shown in Figure 3. It is crucial to take into consideration the reflector's diameter, focal length, and parabolic depth in the construction of the reflector itself.

A variety of theoretical parabolic antenna approaches are examined in this work in order to make predictions about the gain potential of different sources. The F/D ratio of the parabolic reflector used in this investigation was a deciding factor in its selection. Since 0.36 is a frequent ratio for industrial microwave applications [11], this value has been used. Figure 2 shows a common parabolic reflector's geometric design.

It can be deduced from the geometric calculations that the focal distance (F) of the parabolic reflector can be represented in terms of the diameter D and depth C of the parabola as

$$F = \frac{D^2}{16C} \quad (1)$$

Also the aperture illumination can be written as

$$\text{Aperture Illumination} = 2 \tan^{-1} \left[\frac{8 \left(\frac{F}{D} \right)}{16 \left(\frac{F}{D} \right)^2 - 1} \right] \cong 140^\circ \quad (2)$$

$$\text{Considering } \tan \theta = \left[\frac{\left(\frac{D}{2} \right)}{F - C} \right].$$

2.3. Complex Least Mean Square Algorithm (CLMS)

Taking advantage of the LMS's stability and robustness, Widrow et al. introduced the CLMS [9, 10] method in 1975, which can process several complex signals at the same time. Improve complex data modelling and get usable findings using stochastic gradient

descent in complex domain statistics. In [2], the CLMS algorithm is explained in detail. The weight update and output of the CLMS algorithm are as follows:

1) The weight vector's stochastic gradient adaptation is given by

$$w(n+1) = w(n) + \mu x[n]e^*[n], \quad w(0) = 0 \quad (3)$$

2) The CLMS algorithm's output is calculated as

$$y = x^H(n)w(n) \rightarrow w(n+1) = w(n) + \mu x[n]e^*[n] \quad (4)$$

2.4. Adaptive Amplitude Nonlinear Gradient Decent Algorithm (AANGD)

Based on the standard weight update, [9–11] present the adaptive learning rates $\alpha(n)$ for the CLMS, normalized CLMS, and normalized adaptive nonlinear gradient descent (ANGD) algorithms.

$$\alpha(n) = \begin{cases} \mu & \text{for CLMS} \\ \frac{\mu}{|x(n)|_2^2 + \varepsilon} & \text{for CNLMS} \\ \frac{\mu}{|\phi(n)^2||x(n)|_2^2 + \varepsilon} & \text{for ANGD} \end{cases} \quad (5)$$

Regularization parameter epsilon is used to prevent divergence for inputs close to zero. $J(k)$ derivative estimates with respect to epsilon estimators are used in ANGD's 'linear' updates. Weight update gradient's step size (amplification factor) can be adjusted [11, 12] to achieve this. The fact that these algorithms are based on two interconnected unconstrained optimization techniques affects their resilience to parameter initial values (for weights and step size).

The following is the ANGD's core algorithm:

$$e(n) = d(n) - \phi(x^T(n)w(n)) \quad (6)$$

$$\phi(x^T(n)w(n)) = \lambda(n)\phi(x^T(n)w(n)) \quad (7)$$

$$w(n+1) = w(n) + \alpha(n)e(n)\phi^*(x^T(n)w(n)) \quad (8)$$

$$\alpha(n) = \frac{\mu}{|\phi^*(x^T(n)w(n))|^2|x(n)|_2^2 + e(n)} \quad (9)$$

$$\lambda(n+1) = \lambda(n) + \frac{\rho}{2}|e^*(n)\bar{\phi}(x^T(n)w(n)) + e(n)\bar{\phi}^*(x^T(n)w(n))| \quad (10)$$

3. Proposed Smart Patch Array Feed Design

The feed network for the parabolic reflector's patch antenna array is designed to outperform a traditional horn-based antenna. In order to generate the required radiation characteristics in a specific direction, a smart antenna's excitation level and phase can be adjusted for the array elements. By adjusting the filter's weights, adaptive filtering makes it possible to produce any kind of radiation pattern. The disparity between ideal and achieved radiation is employed as a controllable variable. An intelligent

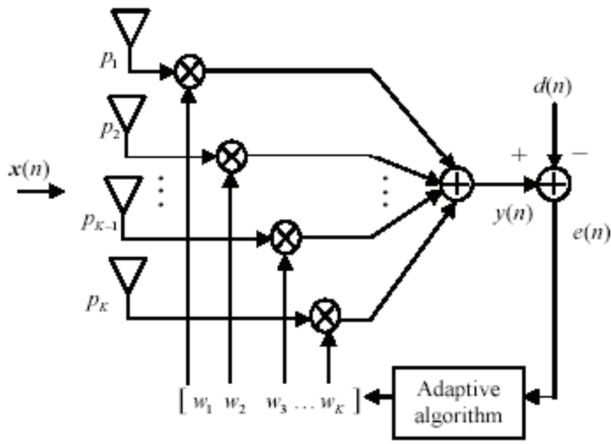

Figure 3. Adaptive array structure

antenna allows for the modification of the radiation pattern. Figure 3 depicts the beamforming process using adaptive algorithms.

The antenna array elements are shown as $P = \{p_1, p_2, \dots, p_k\}$ and the respective weights are represented as $w = \{w_1, w_2, \dots, w_k\}$. For adaptive beam shaping of signals in smart antennas, CLMS and AANGD have been combined to form the hybrid model because each method has advantages and limitations. The control of HPBW vs SLL in CLMS is poor, despite the good convergence of the array output signal to the goal signal. HPBW vs SLL control is good with additional control parameters, similar to AANGD, despite the low convergence of the array output signal towards the target signal.

In the analysis of CLMS and AANGD based on experimental data, the following model suggests combining these two algorithms as a hybrid known as Hybrid of CLMS and AANGD. As an example, consider the following hybrid algorithm:

$$\begin{aligned} y_C(n) &= x^H(n)w_C(n) \rightarrow w_C(n+1) \\ &= w_C(n) + \mu_C e(n)x(n) \end{aligned} \quad (11)$$

$$y_A(n) = h^T(n)z(n) + g^T(n)z^*(n) \quad (12)$$

$$h(n+1) = h(n) + \mu_A e(n)z^*(n) \quad (13)$$

$$g(n+1) = g(n) + \mu_A e(n)z(n) \quad (14)$$

$$e_C(n) = d(n) - x^T(n)w_C(n) \quad (15)$$

$$e_A(n) = d(n) - z^{aT}(n)w_A(n) \quad (16)$$

$$Y_{\text{hybrid}} = \lambda^* Y_C(n) + (1 - \lambda)^* Y_A(n) \quad (17)$$

$$e_{\text{hybrid}}(n) = x - Y_{\text{hybrid}}(n) \quad (18)$$

$$W_{\text{hybrid}}(n+1) = \lambda(n)W_C(n) + (1 - \lambda)W_A^*(n) \quad (19)$$

$$\begin{aligned} \lambda(n+1) &= \lambda(n) + \mu_h \text{Re}(e_{\text{hybrid}}(n)) \\ &\quad (Y_C(n) - Y_A(n)) \end{aligned} \quad (20)$$

Here λ is the mixing parameter, μ_C , μ_A and μ_h are the step sizes for CLMS, AANGD and Hybrid model respectively. The outcome of this feed network is then

given to the parabolic reflector to achieve the desired radiation characteristics.

4. Result Analysis

Simulation analysis through MATLAB software is used to evaluate the proposed design's radiation properties. Table 1 lists the antenna characteristics that were taken into consideration throughout this experiment.

With these characteristics, an electromagnetic scenario is constructed for a smart antenna-based array feed for the parabolic reflector. The simulations are performed with a 1 kHz random noise input source. In order to simulate the real-time environment of the Smart Antenna System, the noise component was taken into consideration alongside the input signal, and the effectiveness of the CLMS and AANGD algorithms was examined with different values of N . When the step size parameter value is decreased in a noisy environment, the performance of the selected algorithms improves. It takes more effort and iterations to get the algorithm to behave as expected when random noise is introduced into the equation.

There is no single direction in which HPBW may be expected to rise or fall, according to the findings of ACLMS. In a noisy environment, low HPBW and SLL can be observed at very low values, but the trend of the data is inconsistent. A decrease in HPBW and SLL can be noticed in this comparison as the adaptive amplitude step size is reduced from its original value of 0.001. One of the most exciting aspects of this development is the fact that it hasn't been seen in previous neural algorithms.

The CLMS method converges faster than the AANGD technique to the target signal. Thus, a hybrid model of these two methods is developed and assessed using the same input and desired signals in order to take use of each algorithm's greatest qualities. Compared to CLMS and ACLMS, this new hybrid algorithm surpassed them in terms of convergence to the target signal.

An example of this technique's simulated results is provided in Figure 5, which shows how phase, magnitude, and accuracy all interact. These reflector's radiation properties are shown in Figures 6 and 7. For the patch antenna array, the radiation pattern is shown in Figure 8. Directivity is weak due to an uneven

Table 1. Antenna parameters

Antenna Parameters	Value
Frequency of operation (f_0)	6 GHz
Length of Feed line	9.5 mm
Field of Radius	0.5 mm
Radiated Power (Watts)	0.046
Directivity(dB)	14.832
Effective angle(deg)	0.41 steradian
E(theta)	81.68
E(phi)	82.68
Gain(dB)	14.8287
Intensity(Watts)	0.112

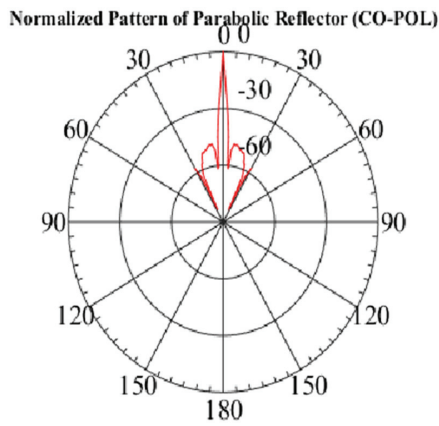

Figure 4. Normalized pattern of reflector

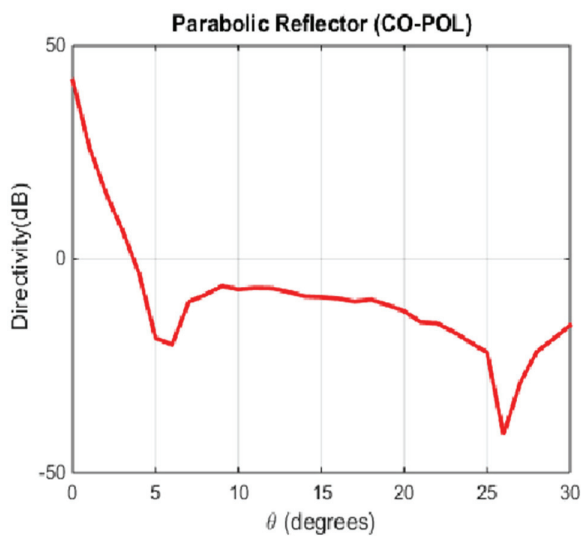

Figure 5. Directivity of the parabolic reflector

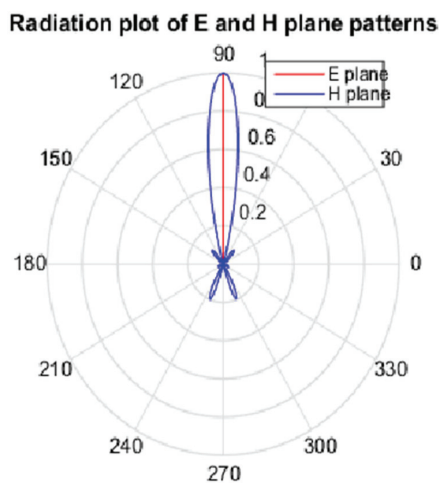

Figure 6. Radiation pattern of patch antenna array without beamforming

power distribution in feeding the reflector antenna. A correction to this can be accomplished by allowing beam creation and feed networks to adapt as needed to signal orientation direction, which will increase SOI's penetration capabilities for sky wave propagation. Beamforming techniques are used to apply beamforming to patch array feed.

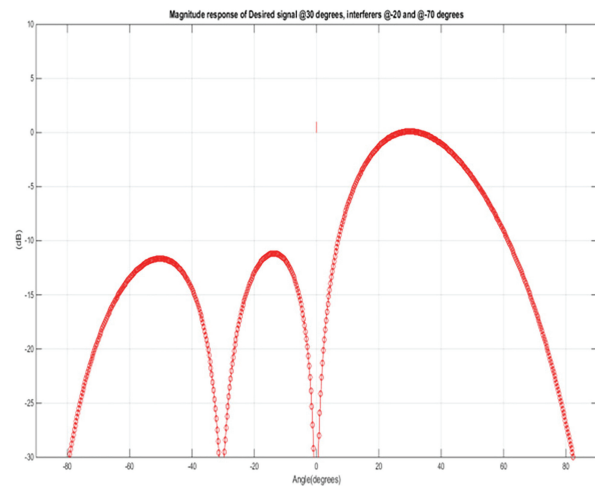

Figure 7. Plot of RLE-LMS algorithm for patch array feed

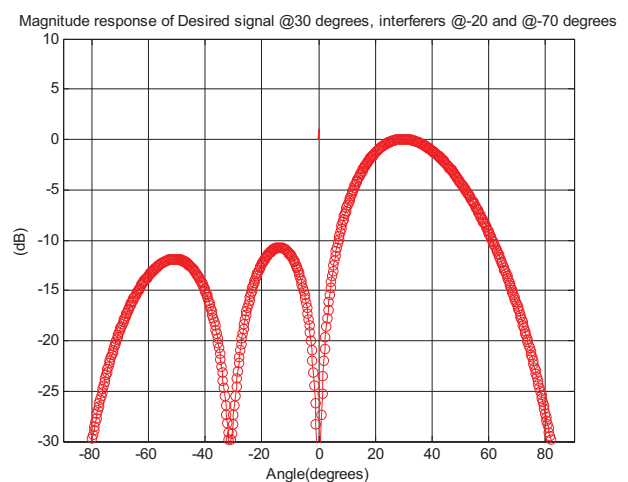

Figure 8. Magnitude response for patch array feed

The results shown in the above figures are generated through a detailed mathematical modelling and respective simulation analysis over MATLAB software. The performance of the proposed technique can clearly be ensured over the real time applications like high frequency satellite communication in C-band. Owing to the correctness and accuracy of the mathematical model, the proposed design when implemented using the high-end technological resources can be guaranteed. Due to the unavailability of high-end costly resources, the novelty of the proposed research is verified through the highly reliable simulation tool which is very closed to the real time scenarios. However, for the future prospects of the research, we can enhance the smartness of the adaptive algorithms using the deep learning models like artificial neural network, convolutional neural network and so on. The performance of the proposed design can be studied over spectrum of other satellite communication as well.

5. Conclusion

The patch array feed suggested in this paper is based on smart antennas. A controlled power distribution is applied to the parabolic reflector to enhance

its radiating properties. A thorough analytical analysis was carried out to look into the antenna design's numerous spectrum properties. The proposed work employs a 4x4 circular patch array for the feed network. According to estimates, the parabolic reflector has an F/D ratio of 0.36 and operates at a frequency of 6GHz. The reflector's aperture illumination is set at 1400. In Smart Antennas, adaptive nonlinear gradient descent and complexly valued neural networks like CLMS are taken into account while producing adaptive beamforming signals. Various criteria, such as the number of array elements, learning rate, initial non-linearity value, and adaptive amplitude step size, are taken into account in both quiet and noisy scenarios. While AANGD exceeds CLMS in terms of good control over these two parameters' adaptation, the analysis of [12] reveals that the latter is superior to the former when it comes to convergence of the target signal, and CLMS outperforms ACLMS in both noisy and noiseless situations. These algorithms are useful for working with signals that exhibit complex dynamic behavior. In order to improve the overall performance of the Smart Antenna System, a hybrid method integrating the best aspects of both models, including CLMS and AANGD, is proposed. Also, it may be possible to combine the CLMS and AANGD models for further improvement.

AUTHORS

Sheetal Bawane* – Medicaps University, India, e-mail: bawane11@gmail.com.

Debendra Kumar Panda – Electronics Engineering Dept. Medi-Caps University, India, e-mail: debendrakumarpananda@gmail.com.

*Corresponding author

References

- [1] F. B. Gross, *Smart Antennas for Wireless Communications with Matlab*. New York: McGraw-Hill, 2005.
- [2] J. Li and P. Stoica, *Robust Adaptive Beamforming*. New Jersey: John Wiley & Sons, Inc., 2006.
- [3] Robert S. Elliott, *Antenna Theory and Design*, Wiley-Inter Science, 2005.

- [4] Veerendra, Md Bakhar, Vani R.M. Smart antennas for next generation cellular mobile communications. *imanager's Journal on Digital Signal Processing* 2016; 4(3): 6–11.
- [5] Amara Prakasa Rao, N.V.S.N. Sarma. Performance Analysis of Kernel Based Adaptive Beamforming for Smart Antenna Systems. *Proc. of the IEEE Int. Conference on Microwave and RF* 2014, pp. 262–265.
- [6] L. Thao, D. Loc, N. Tuyen. "Study comparative of Parabolic array antenna and phased array antenna", *VNU Journal of Science*, vol. 30, no. 3, pp. 31–36, 2014.
- [7] M. Yasin, Pervez. Akhtar, Performance Analysis of LMS and NLMS Algorithms for a Smart Antenna System, *International Journal of Computer Applications*, Vol. 4, No. 9, 2010, pp. 25–32.
- [8] D. K. Panda, "DRLMS Adaptive Beamforming Algorithm for Smart Antenna System", *International Journal of Applied Engineering Research*, vol. 13, no. 8, pp. 5585–5588, 2018.
- [9] D.M. Motiur Rahaman, Md. Moswer Hossain, Md. Masud Rana. "Least Mean Square (LMS) for Smart Antenna", *Universal Journal of Communications and Network*, pp. 16–21, 2013.
- [10] T. N. Ferreira, S. L. Netto, and P. S. R. Diniz. "Direction-of-arrival estimation using a direct-data approach," *IEEE Trans. Aerosp. Electron. Syst.*, vol. 47, no. 1, pp. 728–733, Jan. 2011.
- [11] D. P. Mandic, Yili Xia and Ali H Syad. "An Adaptive Diffusion Augmented CLMS algorithm for Distributed Filtering of Non-Circular Complex Signals", *IEEE Signal Processing Letters*, Vol. 18, No. 11, 2011.
- [12] M. Lertsutthiwong, T. Nguyen, and B. Hamdaoui. "Efficient wireless broadcasting through joint network coding and beamforming," *Int. J. Digit. Multimedia Broadcasting*, vol. 2012, no. 342512, pp. 1–15, 2012.