

Received November 16, 2012; reviewed; accepted May 2, 2013

THE EFFECT OF ROTATIONAL SPEED OF THE DRUM ON PHYSICAL PROPERTIES OF GRANULATED COMPOST FERTILIZER

**Yousef GHASEMI, Mohammad Hossein KIANMEHR,
Amir Hossein MIRZABE, Behnam ABOALI**

Department of Agrotechnology, University of Tehran, College of Abouraihan, Tehran, Iran,
Corresponding author, a_h_mirzabe@ut.ac.ir (A. H. Mirzabe)

Abstract: Granulation is one of the fundamental operations in particulate processing which has an ancient history and a widespread use. Compost fertilizer was granulated using drum granulation method under different level of drum rotational speed. Rotational speed of the drum (ω) ranged from 40 to 60 rev min⁻¹ (40, 45, 50, 55 and 60 rev min⁻¹). The effect of rotational speed of the drum (ω) on some physical properties of granulated compost fertilizer including: useful granules, granules size, fracture force, mass of the granules, bulk density, angle of friction and angle of repose are investigated in the present study. Results indicated that with the increasing drum rotational speed the percentage of useful granules, fracture force, bulk density, angle of friction and angle of repose increase from 69.91% to 80.88%, 34.35 N to 35.23 N, 743.23 to 765.08 kg m⁻³, 26.50 to 28.01° and 10.83 to 12.88°, respectively. Also the average size of granules decreases from 10.15 to 7.05 mm.

Keywords: drum granulation, compost fertilizer, drum rotational speed, fracture force, granule size, granule mass

Introduction

High moisture content, high volume and non-uniformity of the materials in manure are the factors that limit the usage of the manure in agriculture. Normally, because of low specific gravity the transportation of manure fertilizers is difficult and expensive (Ghadernejad et al., 2012). Biomass is very difficult to handle, transport, store and utilize in its original form (Sokhansanj et al., 2005). On the other hand governments are looking for ways to dispose of municipal, mineral, industrial, and agricultural wastes. Spreading these wastes on agricultural land is perceived as the most appropriate solution if the wastes can be used to support plant production (Allaire and Parent, 2004). These wastes were spread directly on agricultural land. When the

wastes are combined with mineral fertilizers, the mineral part may compensate for the lack of certain nutrients in the wastes while the organic matter could improve the efficiency of the mineral fertilizers (Allaire and Parent, 2004).

One method to get easy storage, transportation, dispose of agricultural wastes and to decrease the costs is to reduce the volume of the manure by compression in granule form. The compressed manure can be used as the fertilizer in agricultural farms. This also eliminates the need for manure plants and reduces the cost of manure (Adapa et al., 2003). The agglomeration of fertilizer granules in storage, known as caking or bag set, is a significant quality assurance problem for the fertilizer industry. The agglomeration of fertilizer granules can take place over weeks or months in storage (Walker et al., 1999).

Granulation is one of the fundamental operations in particulate processing and has an ancient history and a widespread use. Much fundamental particle science has developed over the last few years to help understand the underlying phenomena. Yet, until recently the development of granulation systems was mostly based on popular practice (Cameron et al., 2005).

While a lot of research concerning granulation processes and physical and mechanical properties of granules in chemistry and pharmacy sciences have been made, a limited number of published literature are available about physical and mechanical properties of fertilizer granule. The mechanisms for granule growth (granulation) including nucleation, growth, random coalescence, pseudo-layering and crushing and layering were studied by Sastry and Fuerstenau (1973). Coalescence agglomeration occurs when two or more particles adhere together using a liquid as the binding agent. In industrial processes, binding liquids include water, water-based solutions and melts. Coalescence is random if the rate of agglomeration is size independent or preferential if agglomeration is size dependent (Walker et al., 2000). Litster and Liu (1989) in their research on the granulation of fertilizers have found that coalescence is the most probable mechanism for low temperature fertilizer granulation using a feed with a broad particle size distribution.

In the operation of drum granulation systems there are a number of process parameters that will affect the extent of size enlargement and physical properties of the final granulate. One of the important parameters is drum rotational speed. With low rotation speed, the granulate slides about the bottom of the drum with little agitation of the granules, with increasing drum speed the granule begins to roll, cascading occurs and the probability of agglomeration increases (Sherrington and Oliver, 1981). It has been suggested that the optimum drum speed is half the critical speed, where the critical speed is defined as the speed at which the dry material will be carried around the drum by centrifugal force (Walker et al., 2007). Effect of the viscosity of binder solution, flight arrangement and critical speed on fertilizer granulation procedure were studied by Walker et al. (2000).

The effect of the granulation parameters on physical properties of the granules is one of the most important factors in optimal granulation conditions. Therefore the

objective of the present work is to investigate the effect of rotational speed of the drum (ω) on some physical properties of granulated compost fertilizer including: useful granules, granules size, fracture force, mass of the granules, bulk density, angle of friction and angle of repose.

Materials and method

Production of granules

The powder used in the production of the granules was multicomponent fertilizer powder supplied by Moshaver Haseb Company. The granules were produced in a no internal flights drum granulation. Production of the granules for each batch was repeated three times. A schematic diagram of the experimental set up is shown in Fig. 1. Drum (3) was driven by electromotor (5) by means of a belt transmission and a clutch. A change of rotational velocity of the drum was obtained by means of inverter (6). The granular bed placed in the drum was wetted drop-wise by means of sprinkler (4), which was introduced axially to the device that ensured a uniform liquid supply. The sprayer was mounted on stand (8), which was independent of the granulator. The wetting liquid (Sugar beet molasses) was supplied from reservoir (1), placed at the height of 300cm from the drum axis and its constant flow rate ($Q = 10^{-6} \text{ m}^3/\text{sec}$) was fixed by means of rotameter (2). During the experiment a constant liquid level was kept in the tank, which guaranteed a constant pressure of supplied liquid. The granular bed was wetted until the material got over-moist which caused that the bed stuck to the inner wall of the granulator (Obraniak and Gluba, 2012).

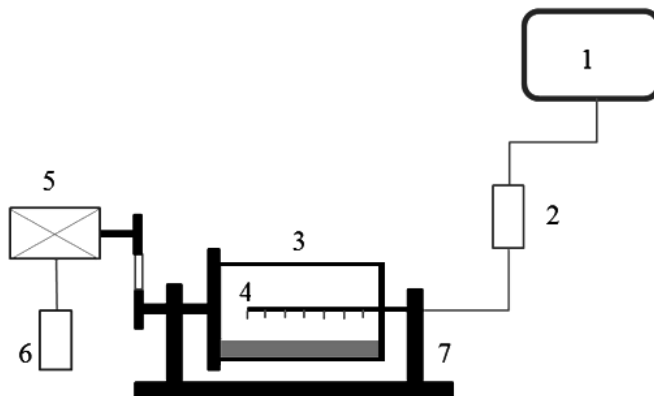

Fig. 1. A schematic diagram of the experimental set up

In the present work the following parameters were used: drum diameter $D = 200$ mm; drum length $L = 380$ mm, filling of the drum with granular material $\phi = 7.5\%$. The solution to solid phase ratio, defined as the ratio of volume of liquid phase to that

of solid phase in the granule and is given by the equation 1 cited by Walker et al. (2000):

$$y = \frac{M(1-S)\rho_s}{(1-MS)\rho_L} \quad (1)$$

where y is solution to solid phase ratio, M is the moisture content, S is the fertilizer solubility, ρ_s is the solid fertilizer density and ρ_L is the liquid fertilizer density. For each granulation system, the fertilizer liquid and solid densities must remain constant.

Rotational speed of the drum (N) ranged from 40 rev min⁻¹ to 60 rev min⁻¹ (40, 45, 50, 55 and 60). The range change of drum angular velocity is selected in such a way to provide cascading – the typical feed movement for drum tumbling granulators (Obraniak and Gluba, 2012).

The critical rotational speed within drums is the speed at which material can be just carried around the drum by centrifugal action. In terms of the Froude number describing the ratio of inertial to gravitational forces, the critical rotational speed can be defined as:

$$\omega_{cr} = \frac{42.4}{\sqrt{D}} \quad (2)$$

where: ω_{cr} is the critical rotational speed (rev min⁻¹) and D is the drum diameter (m).

In practice, good granulation can be achieved in drums containing no internal flights when rotational speed (ω) ranged from $0.3\omega_{cr}$ to $0.5\omega_{cr}$. In the present work critical speed $\omega_{cr} = 94.81$ rev min⁻¹ is calculated using equation 2.

After granulation processes, wet granules were left in the atmosphere to dry. After being dried in the atmosphere, the granules were collected for measuring their physical properties.

Physical properties of granules

Physical properties of produced granules and effect of the granulation parameters on physical properties of the granule is one of the most important factors in optimal granulation conditions. Effect of the drum rotational speed on some physical properties of produced granules including: useful granules, granules size, granules fracture resistance, granules mass, bulk density, coefficient of friction and angle of repose of granules were studied in the present work.

Useful granules

For the purpose of the present work granules in the size range 5 to 10 mm were required. It was therefore necessary to optimize the process to ensure that the larger fraction of the granules from each batch would be within this size range. Any granules that are larger than 4 mm are regarded as oversize and these would need to be crushed in a continuous granulation circuit. Any granules passing through 5 mm were

classified as fines and these could be recycled by reintroducing them into the granulation process. The efficiency of the process, η , is defined as the percentage of the product which meets the size requirement (Mangwandi et al., 2012):

$$\eta = \frac{M_{\text{Target}}}{M_{\text{Total}}} \cdot 100 \quad (3)$$

where M_{Target} is mass of useful granules and M_{Total} is mass of the batch granules. The mass of the useful granules batch using sieving was measured. Determination of the percentage of the useful granules was repeated three times.

Granules size

The size distribution of the produced granules for each batch was determined using sieving. The stack of sieves with the granules was placed on an orbital sample shaker. Retsch sieves (Retsch GmbH, Germany) were used in the size analysis and the aperture sizes are as follows; 850, 1000, 1180, 1700, 2360, 3350, 4750, 12700 and 19050 μm . The duration of sieving was adjusted according to size of the sample. The sieving times for the 500 g batches were 22 min respectively at a speed of 180 rpm. The masses of granules retained on the sieves to determine the size distribution of the granules were used. Determination of the average of the granule size was repeated three times.

Granules fracture force

To investigate fracture force, for each rotational speed of the drum, 20 granules in the shape close to spherical were taken from the bulk sample, and next each granule was placed separately between parallel compressing plates (mobile and immobile). The test lasted until the moment when the granule was destroyed between the compressing plates. Pneumatics press for measuring fracture force of the granules was used (Fig. 2).

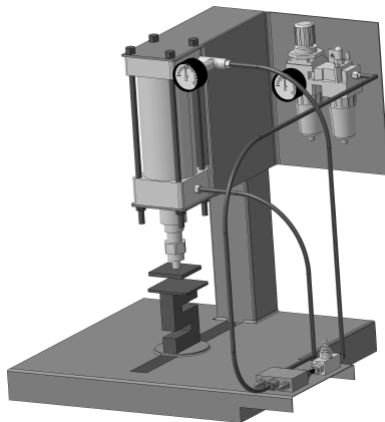

Fig. 2. Schematic of the pneumatics press

Bulk density

One of significant parameters that describe the properties of granular materials is bulk density. For the determination of bulk density, the bulk material (granules) was put into topless cylindrical container with known weight, height (150 mm) and volume (500 dm³) from a height of 150 mm at a constant rate (Dash et al., 2008; Singh et al., 1996; Sacilik et al., 2003). Bulk density (ρ_b) was calculated from the mass of bulk granules divided by volume containing the mass. Measurement of the bulk density was repeated ten times.

Mass of the granules

In order to determine the effect of the drum speed on mass of the single granule, 100 granules were selected from the bulk samples, quite randomly. Then mass of the granules was measured. From bulk sample 300 granules were selected quite randomly; then granules were divided into three bins so that in each bin 100 seeds were placed. Bin weight was measured and multiplied by 10 to give mass of 1000 granules. The mass of the single granule and 1000 granules mass were measured using a digital balance with an accuracy of 0.01g.

Mass of granules distribution was modelled using log-normal probability density functions. The probability density functions $f(x)$ and cumulative frequency functions (F(x)) for Log normal distribution are showed in equation 4 and 5.

$$f(x) = \frac{1}{(x - \gamma)\sigma\sqrt{2\pi}} \exp\left[-\frac{1}{2}\left(\frac{\ln(x - \gamma) - \mu}{\sigma}\right)^2\right] \quad (4)$$

$$F(x) = \Phi\left(\frac{\ln(x - \gamma) - \mu}{\sigma}\right), \quad \varphi(x) = \frac{1}{\sqrt{2\pi}} \int_0^x e^{-\frac{t^2}{2}} dt \quad (5)$$

According to the equation 4 and 5, for the log-normal distribution, μ is scale parameter, σ is shape parameter and γ is location parameter. Whenever γ is equal to zero log-normal distribution is called two parameters distribution, otherwise it is called three parameters distribution. Whenever γ is equal to zero and μ equals one the log-normal distribution is called standard log-normal distribution (Mirzabe et al., 2012). In this study, Log-normal distribution with two parameters was used.

Angle of friction

The coefficient of external static friction, using iron sheet, was determined. A topless and bottomless metallic box with known dimensions (length 100 mm, width 100 mm and height 50 mm) was put on the surface. The box was filled by granules. The surface was gradually raised by the screw. Both horizontal and vertical height values were measured using a rule and digital caliper when the seeds started sliding over the surface and, the coefficient of static friction was calculated using the following equation (Burubai et al, 2007):

$$\mu_s = \tan A_F \quad (6)$$

where: μ_s is coefficient of static friction; A_F is angle of static friction. Measurement of the angle of friction was repeated ten times.

Angle of repose

Static angle of repose of granules was measured by the use of pouring method (Fraczek et al., 2007). The angle of repose was determined using a topless and bottomless metallic cylinder of 250 mm height and 150 mm diameter. The cylinder was placed at the iron surface and was filled with bulk material. The cylinder was raised very slowly. The height and diameter of the cone was measured using digital caliper and the static angle of repose was calculated using the following equation cited by Mirzabe et al. (2012):

$$A_R = \arctan\left(\frac{H}{R}\right) \quad (7)$$

where: A_R is angle of repose; H is height of the cone; R is radius of the cone. Measurement of the angle of repose was repeated ten times.

Results and discussion

The effect of rotational speed of the drum (ω) on some physical properties of granulated compost fertilizer including: useful granules, granules size, fracture force, mass of the granules, bulk density, angle of friction and angle of repose were investigated in present study.

Useful granules

The effect of rotational speed of the drum on percentage of the produced useful granules (η) is illustrated in Fig. 3. According to Fig. 3 with increasing drum rotational speed from 40 rev min⁻¹ to 60 rev min⁻¹, percentage of the produced useful granules was increased from 69.9% to 80.9%. For the purpose of present work granules in the size range 5 to 10 mm were required. Therefore maximum percentage of the useful granules was produced when the rotational speed of the drum was equal to 60 rev min⁻¹.

Granules size

The effect of drum rotational speed on average of produced granule size (D_{50}) is illustrated in Fig. 4. According to Fig. 4 with increasing drum rotational speed from 40 rev min⁻¹ to 60 rev min⁻¹, average size of the produced granules was decreased from 10.15 mm to 7.05 mm. The effect of drum rotational speed on average size of produced granule of potassium nitrate was investigated by Rojas et al. (2005). Result

indicated that, when the rotational speed increased from 4 to 7 rev min⁻¹ (RPM) average size of the produced granules decreased.

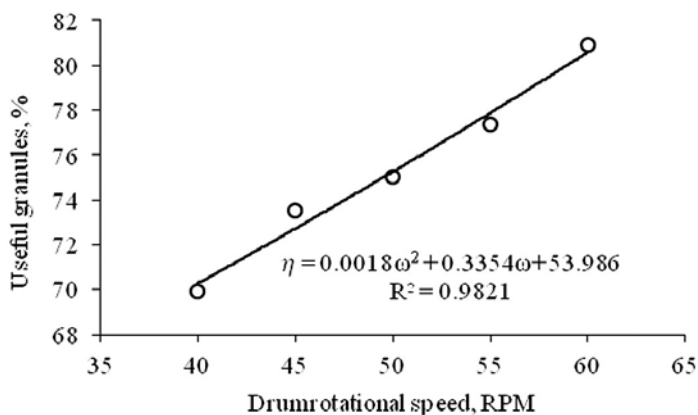

Fig. 3. Effect of drum rotational speed on percentage of useful granules

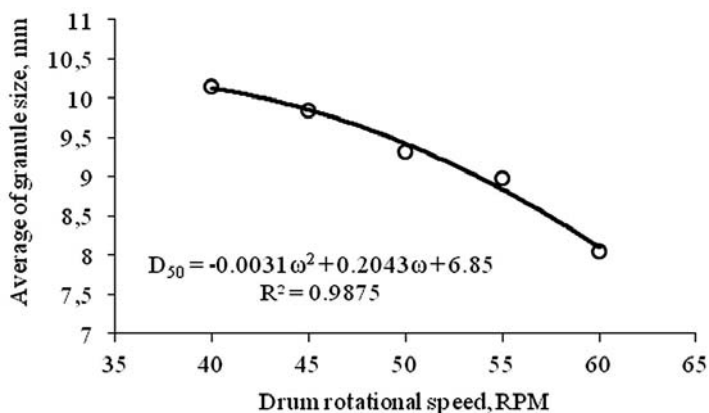

Fig. 4. Effect of drum rotational speed on average of size

Fracture force

The effect of drum rotational speed on fracture force of the produced granules (F) is illustrated in Fig. 5. According to Fig. 5 with increasing drum rotational speed from 40 rev min⁻¹ to 60 rev min⁻¹, fracture force of produced granules was increased and then decreases from 34.35 N to 35.23 N.

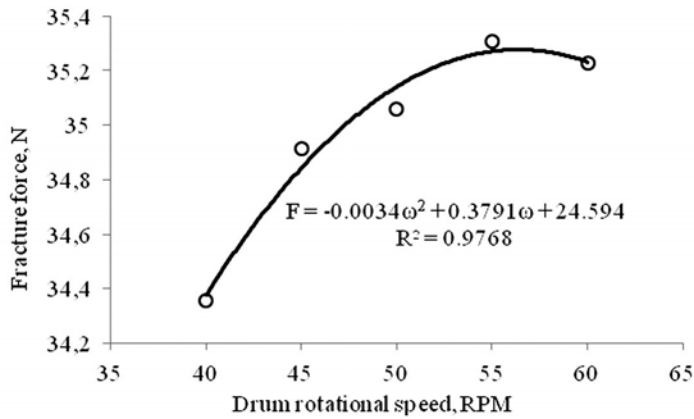

Fig. 5. Effect of drum rotational speed on fracture force

Bulk density

The effect of drum rotational speed bulk density of produced granules (ρ_b) is illustrated in Fig. 6. According to Fig. 6 with increasing drum rotational speed from 40 rev min⁻¹ to 60 rev min⁻¹, bulk density of the produced granules was increased from 743.23 kg m⁻³ to 765.08 kg m⁻³. The effect of rotational speed on bulk density of produced granules of bentonite was investigated by Heim et al. (2005). The results indicated that the effect of relative rotational speed appeared to be very small and could be considered negligible.

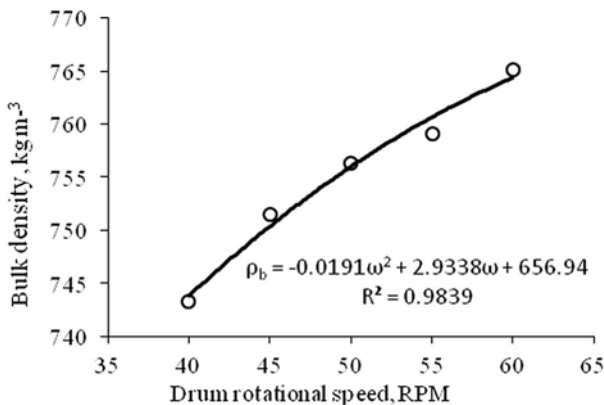

Fig. 6. Effect of drum rotational speed on bulk density

Mass of the granules

The effect of drum rotational speed on mass of the produced granules (M_1) is illustrated in Fig. 7. According to Fig. 7 with the increase of the drum rotational speed

from 40 rev min⁻¹ to 50 rev min⁻¹, mass of the produced granules increased from 0.486 g to 0.639 g; but with the increase of drum rotational speed from 50 rev min⁻¹ to 60 rev min⁻¹ mass of the produced granules decreased from 0.639 g to 0.548 g.

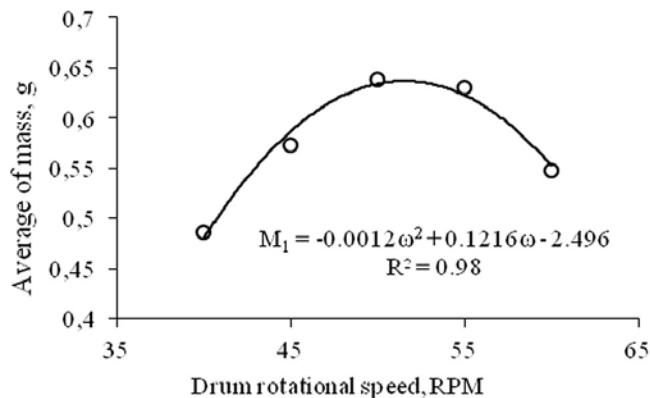

Fig. 7. Effect of drum rotational speed on mass of granules

The distribution of mass of granules was modeled using log-normal probability density functions. The value of the log location parameter, log scale parameter, mean of log-normal distribution, variance of log normal distribution and log likelihood for each rotational speed were calculated (Table 1). The probability density functions of log-normal distributions for all rotational speed are showed in Fig. 8.

Table 1. Parameters of log normal distributions for mass of the granules

Rotational speed (rev min ⁻¹)	Log location parameter	Log scale parameter	Mean of distribution	Variance of distribution	Log likelihood
40	-1.012	0.892	0.540	0.355	-14.082
45	-0.797	0.814	0.628	0.371	-20.329
50	-0.655	0.681	0.655	0.253	-18.481
55	-0.661	0.761	0.690	0.373	-23.746
60	-0.854	0.849	0.610	0.393	-19.548

Angle of friction

The effect of drum rotational speed on angle of friction of produced granules (A_F) is illustrated in Fig. 9. According to Fig. 9 with increasing drum rotational speed from 40 rev min⁻¹ to 60 rev min⁻¹, angle of friction of the produced granules was decreased from 26.50° to 28.01°.

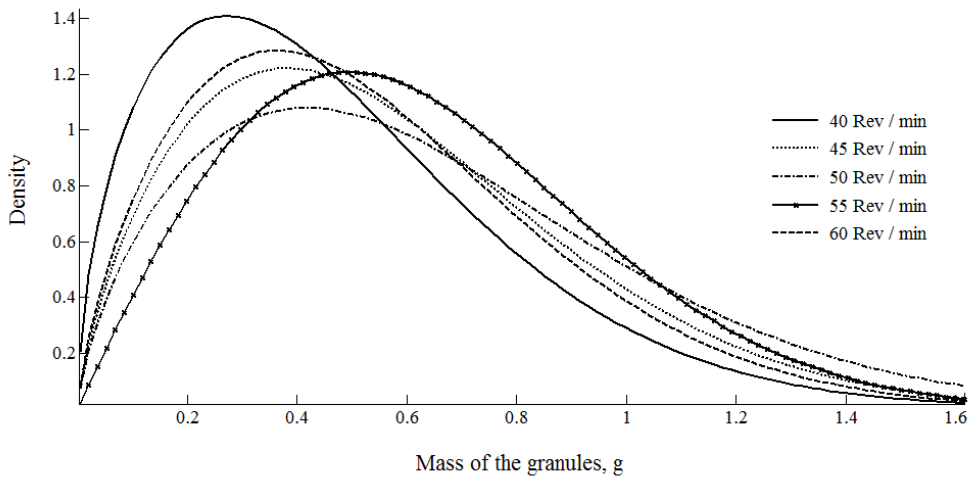

Fig. 8. Probability density function of Log normal distributions for all rotational speed

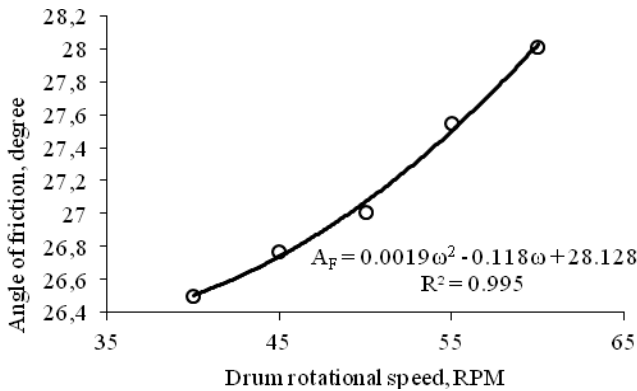

Fig. 9. Effect of drum rotational speed on angle of friction

Angle of repose

The effect of drum rotational speed on the angle of repose of produced granules (A_R) is illustrated in Fig. 10. According to Fig. 10 the angle of repose of the produced granules decreased from 10.8° to 12.9° with increasing drum rotational speed from 40 rev min^{-1} to 60 rev min^{-1} . Results of the angle of friction indicated that, with increasing drum rotational speed, angle of repose of the produced granules increased. Perhaps, with increasing drum rotational speed internal friction coefficient between granules increased, therefore with increasing coefficient of friction, angle of repose of the produced granules increased. Also increase in the value of the angle of repose with the increase in drum rotational speed can be caused by the size and shape of the granules.

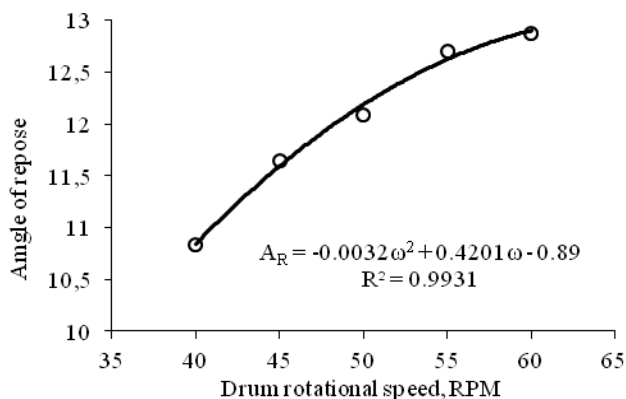

Fig. 10. Effect of drum rotational speed on angle of repose

Conclusions

In present study the effect of drum rotational speed (ω) on useful granules, granules size, fracture force, mass of the granules, bulk density, angle of friction and angle of repose of granulated compost fertilizer were investigated. The result indicated that, when the rotational speed increased from 40 to 60 rev min⁻¹:

1. percentage of the produced useful granules increased,
2. average size of the produced granules decreased,
3. fracture force of produced granules increased,
4. bulk density of the produced granules increased,
5. speed mass of the produced granules increased,
6. speed angle of friction of the produced granules decreased,
7. speed angle of repose of the produced granules decreased.

Acknowledgements

The authors would like to thank Dr. Jafar Massah, Dr. Javad Khazaei, Dr. Akbar Arab Mohammad Hoseini, Mr. Ebrahim Sharifat, Mr. Mohammad Hassan Torabi Ziaratgahi, Mr. Rasool Sohrabi Khah and Ms. Zohre Torki for his technical supervision and help while writing the paper.

References

- ADAPA P., BUCKO J., TABIL JR L., SCHOENAU G., SOKHANSANJ S, 2003, *Pelleting characteristics of fractionated suncore and dehydrated Alfalfa grinds*, The society for in agricultural, food, and biological systems, 192–207.
- ALLAIRE S. E., PARENT L. E, 2004, *Physical properties of granular organic-based fertilizers, Part 1: Static Properties*, Biosystems Engineering, 87 (1), 79–87.
- BURUBAI W., AKOR A. J., IGONI A. H., PUYATE Y. T, 2007, *Some physical properties of African nutmeg (Monodora myristica)*, Int. Agrophysics, 21, 123-126
- CAMERONA I. T., WANGA F. Y., IMMANUEL B. C. D., STEPANEK B. F, 2005, *Process systems modeling and applications in granulation: a review*, Chemical Engineering Science, 60, 3723 – 3750.

- DASH, A. K., PRADHAN, R. C., DAS, L. M., NAIK, S. N., 2008, *Some physical properties of simarouba fruit and kernel*, International Agrophysics, 22(2), 111.
- FRACZEK J., ZŁOBECKI A., ZEMANEK J., 2007, *Assessment of angle of repose of granular plant material using computer image analysis*, Journal of Food Engineering, 83: 17–22
- GEZERMAN A. O., 2012, *Design of a Fluidized Drum Granulator for Ammonium Nitrate Production*, International Journal of Modern Engineering Sciences, 1(2), 88-96
- GHADERNEJAD K., KIANMEHR M. H., ARABHOSSEINI A., 2012, *Effect of moisture content and particle size on energy consumption for dairy cattle manure pellets*, AgricEngInt: CIGR Journal, 14(3), 125–130.
- HEIM A., OBRANIAK A., GLUBA T., 2005, *Changes of Feed Bulk Density During Drum Granulation of Bentonite*, Physicochemical Problems of Mineral Processing, 39, 219–228
- LITSTER J. D., LIU, L. X., 1989, *Population balance modelling of fertilizer granulation*, Proc 5th International Symposium on Agglomeration, Sept 25-27, Brighton UK, 611-621.
- MANGWANDI C., ALBADARIN A. B., AL-MUHTASEB A H., ALLEN S.J., WALKER G M, 2012, *Optimisation of high shear granulation of multicomponent fertiliser using response surface methodology*, Powder Technology, article in press.
- MIRZABE A.H., KHAZAEI J., CHEGINI G.R., 2012, *Physical properties and modeling for sunflower seeds*, AgricEngInt: CIGR Journal, 14(3) 190–202.
- OBRANIAK A., GLUBA T., 2012, *Model of energy consumption the range of nucleation and granule growth in drum granulation of Bentonite*, Physicochemical Problems of Mineral Processing. 48(1), 121–128.
- SACILIK K., OZTURK R., KESKIN R., 2003. *Some physical properties of hemp seed*, Biosystems Engineering, 86 (2), 191–198.
- SASTRY. K. V. S., D.W. FUERSTENAU, 1973, *Mechanisms of Agglomerate Growth in Green Pelletization*, Powder Technol, 7, P97–P105.
- SHERRINGTON P. J., OLIVER R., 1981, *Globulation processes, in granulation*, Heyden and Son Ltd, London, 118–140.
- SINGH K. K., GOSWAMI T. K., 1996, *Physical properties of cumin seed*, Journal of Agricultural Engineering Research, 64 (2), 93–98.
- SOKHANSANJ S., MANI S., BI X., ZAINI P., TABIL L. G., 2005, *Binderless pelletization of biomass*, ASAE Annual International Meeting, Tampa Convention Centre, Tampa, Florida July 17-20, Paper Number 056061, 2950 Niles Road, St. Joseph, MI 49085–9659, USA.
- WALKER G. M., HOLLAND C. R., AHMAD M. N., 1999, *Granular fertilizer agglomeration in accelerated caking tests*, Ind. Eng. Chem, Res, 38, 4100–4103.
- WALKER G. M., HOLLAND C. R., AHMAD M. N., FOX J. N., KELLS A. G., 2000, *Drum granulation of NPK fertilizers*, Powder Technology, 107, 282–288.
- WALKER, G. M., 2007, *Chapter 4: Drum Granulation Processes*, Handbook of Powder Technology, 11, 219–254.

