

METHOD FOR DETERMINING THE AIR CHANGE EFFECTIVENESS OF THE AUXILIARY FORCING VENTILATION SYSTEM IN UNDERGROUND MINES USING CFD SOFTWARE

Vancho ADJISKI*, Dejan MIRAKOVSKI,
Zoran DESPODOV, Stojance MIJALKOVSKI

Faculty of Natural and Technical Sciences, Mining Engineering, “Goce Delchev” University, P.O. Box 201,
2000 Shtip, Macedonia

Abstract: Auxiliary forcing ventilation system is the most common air distribution system of the development headings in underground mines. This paper reports the development of numerical analysis for calculating the Air Change Effectiveness (ACE) of ventilation performance for auxiliary forcing ventilation system in underground mines. The methodology presented in this paper will be demonstrated through Computational Fluid Dynamics (CFD) modelling and calculated in accordance with ASHRAE F25-1997 methodology. Local age, Mean Age of Air (MAA) and ACE were calculated in three scenarios using CFD modelling to study the ventilation performance. ACE was calculated at locations in the development headings occupied space, based on the MAA from the same ventilation system parameters in three different scenarios. Simulation results indicate that ACE is influenced due to the involvement of objects in the development heading that can reduce the effective volume of the zone. This study provides some new ideas for measuring ACE which can provide better auxiliary ventilation system in underground mines. The proposed methodology could be applied as guidance for design and setup of auxiliary ventilation systems. Results from this CFD modelling will be used for extensive validation study which purpose will be to prove the accuracy of the methodology and, if necessary, to improve it.

Keywords: *underground mines, auxiliary ventilation, development heading, air change effectiveness, mean age of air*

Corresponding author: vanco.adziski@ugd.edu.mk (V. Adjiski)

1. INTRODUCTION

Concern for air quality inside underground mines has grown over the past years as results of making better work environment for the miners. Ventilation in underground mines is now a vital component to improve the work conditions and properly dilute the pollutants. The objective of the auxiliary forcing ventilation system in underground mines is to deliver the necessary air quantity and quality to all development headings through the use of a combination system of fans, ducts and air flow controls (De Souza 2004). Because auxiliary forcing ventilation system is now expected to maintain a much better balance between human health and work environment, many researches have been devoted to study the performance or the effectiveness of this ventilation system.

The purpose of this study was focused on the development of a method for determining the Air Change Effectiveness (ACE) of the auxiliary forcing ventilation system in underground mines using CFD software. ACE describes the ability of a ventilation system to deliver ventilation air to a zone, space or how well the air is distributed within the breathing height (Amai & Novoselac 2016).

This study was undertaken to investigate the ACE and also to answer the following questions:

- Is there fast and inexpensive method for calculation of ACE of the auxiliary forcing ventilation system in underground mines?
- Whether the age of air that is delivered to the breathing zone inside development heading can be determent?
- Whether the ACE will change under the same ventilation parameters if we add objects in the development heading?

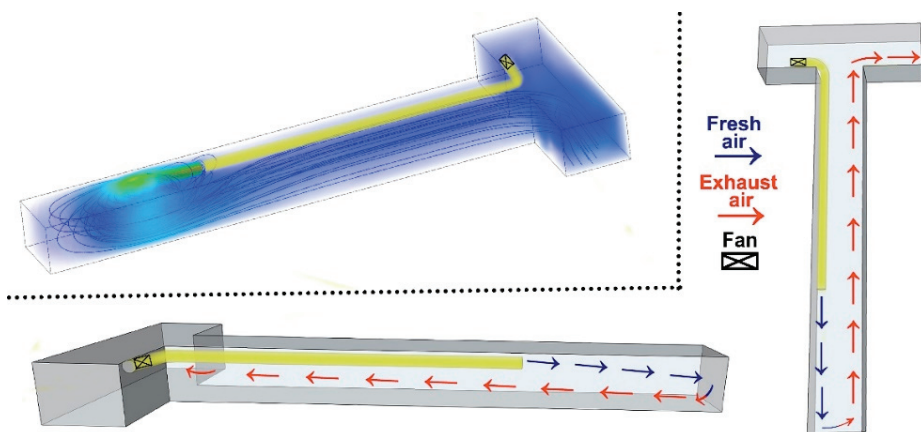

Fig. 1. Auxiliary forcing ventilation system in underground mines

In the past, numerous methods have been developed to measure ACE based on laboratory testing and with tracer gas techniques (Federspiel 1999). The previously developed methods for measuring ACE suffer from a series of limitations that have prevented them to be widely used in the field of auxiliary forcing ventilation system do to the fact that they are too expensive, complicated and difficult (Han et al. 2002; Xing et al. 2001; Fisk et al. 1997; Tomasi et al. 2013).

In the process of development, it was decided that the method for measuring ACE, has to be quick, easy, inexpensive and reliable. Also this method, has to avoid disturbing the ventilation system and miners during working hours. Finally, it was felt that the method should be simple enough to be applied by practitioners involved within the underground mine.

2. LITERATURE REVIEW

To develop this method for determining the ACE of the auxiliary forcing ventilation system proposed within this paper, it was first necessary to retrace the steps and procedures followed by other researchers in the development and implementation of their methods. This section reviews the currently published studies for determining ACE of ventilation systems.

Xianting et al. (2003a) developed algorithm for calculating fresh air age in central ventilation system which is based on the analysis of air mixing and air flow in duct. The calculation of fresh air age is an important index to evaluate indoor environment.

Stokes et al. (1987) in their study emphasize the usefulness of Sulphur hexafluoride as a tracer gas for mine ventilation studies. This study presented details of two tracer gas techniques used and the derived results include: air quantity flows, single air exchange times, air path volume and the average residence times.

Widiatmojo et al. (2014) investigated the air residence time in a cavity using tracer gas and the decay time was measured for the gas to completely escaped from the cavity. The cavity's ventilation efficiency and the air exchange rates were also investigated in this study.

Sandberg (1981) is the first who applied the concept of age of air to ventilation system studies. In his research he summarized various definitions of ventilation efficiency. He stated that the sooner the supply ventilation air reaches a particular point in the room, the greater the ACE at that point. This concept presents the basis and is widely accepted by many researchers and organizations including AIVC and ASHRAE.

Monteiro & Castro (2014) investigated and measured thirteen strategies of air diffusion in a test chamber through the use of tracer gas method, with the objective to validate the calculation by CFD. In this study they compared the ACE and the Contaminant Removal Effectiveness (CRE) and the main results from this research shows

that the values of the numerical simulations are in good agreement with experimental measurements.

Daghigh & Sopian (2009) investigated thermal comfort level of an air-conditioned room as a function of maximum, minimum and mean ACE. The tracer gas decay method has been applied during the experimental procedures to estimate ACE. This research has shown that thermal comfort is influenced by ACE.

Novoselac & Srebric (2003) investigated ACE and contaminant removal effectiveness as suitable indicators for use in design and on-site measurements. These two parameters were numerically studied and compared for five typical indoor spaces with different contaminant sources and ventilation strategies. Based on the results of this research, designers could select an air quality indicator that is more appropriate for their particular ventilation strategies.

Jones & Whittle (1992) investigated the application of CFD to environmental design inside buildings and concluded that CFD codes can be successfully applied to air flow prediction but they must be used with engineering judgement to get the best from them.

Most of the studies that research this field focused on determining the ACE of ventilation systems inside buildings and offices and very few studies focused on investigating the ACE of ventilation systems in underground mines. This research will present a low-cost methodology for determining the ACE of the auxiliary forcing ventilation system, that will help to improve the working conditions inside development heading in underground mines.

3. METHODS

3.1. THE AGE OF AIR CONCEPT

The age of air is defined as the time passed by since this molecule entered the zone, space or the room (Xianting et al. 2003b). Consider a point X in a development heading with one supply air inlet. The age of air will be the length of time required for the supply air to reach that point. As the air can reach this point through various different paths, the mean value is called the Local Mean Age (LMA) of the air at point X. LMA represents the un-freshness of supply air, a longer age of air suggests poorer air delivery compared to a short age of air for the same location, so that it can be used as a local supply index at the point (Buratti et al. 2011). Arithmetic averaging of all these LMA result in the Mean Age of Air (MAA) of the room or space. The age of air has units of time (seconds or minutes), so it is not a true “effectiveness” or “efficiency” measure, but can point out or give indication of problems within a space or zone (Padilla-Marcos et al. 2017). The value of MAA characterizes the effectiveness of the ACE of the entire room or space as it is addressed the air distribution within the room or space as well as the supply air volume.

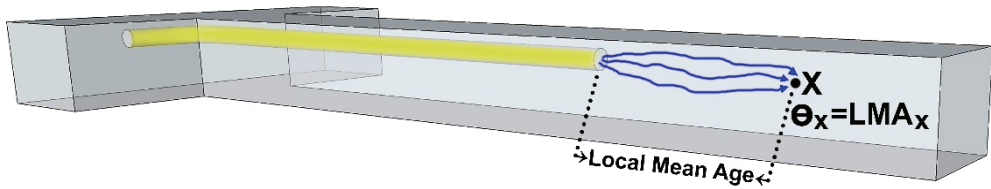

Fig. 2. The age of air concept inside development heading

3.2. AIR CHANGE EFFECTIVENESS (ACE)

ASHRAE Handbook (1997) states that ACE is defined as a description of a system's ability to deliver ventilation air to a zone or space, whereas ventilation effectiveness is a description of an air distribution system's ability to remove internally generated pollutants from a zone or space. The definition of ACE can be formulated by stating that the main goal of the auxiliary forcing ventilation system in a development heading is to reduce MAA to a minimum value.

According to this, the minimum MAA or the optimum ventilation time has to be defined with respect to a standard reference value which in theory could be reduced to a value near zero if enough ventilation air is delivered into a development heading. However, this is not practical since the ventilation flow rate inside the development heading would be too high for human comfort and there is the risk of additional dust particles that can be picked up by the air stream which reduces the quality of the air in the ventilated place (McPherson 1993). With this in mind the minimum value for MAA must be established based on a different criterion than time alone. This criterion, consists in comparing the airflow rates with a theoretical estimate of the best or optimum MAA in the development heading. This value is represented by τ_n and is referred as the nominal time constant of the development heading. The value of τ_n , is obtained using mathematical formulation based on models used to predict the time for a volume of air to ventilate the development heading.

For analysis purposes, as shown in Fig. 3, the air movements in a development heading can be assumed to follow two types of behavior based on the auxiliary ventilation setup a) piston flow, b) short-circuiting flow. When the auxiliary ventilation is setup with combining the advantages of forcing and exhausting ducts (overlap systems) then we will assume that the air will follow piston flow behavior (Fig. 3a), and when the auxiliary ventilation is setup using forcing or exhausting ducts that we will assume short-circuiting flow (Fig. 3b). The created airflow patterns in the development heading based on the auxiliary ventilation setup are shown with arrows on Fig. 3, and the resulting effect of these airflows on pollutants is shown in greyed areas from a point source.

As shown, in the piston flow all the molecules of air go from the ventilation inlet of the development heading directly to the other side to be released from the outlet (Fig. 3a).

In short-circuiting flow, the air in the space has variations in the age and in some regions we can assume mixing flow where the air has the same age (short-circuiting areas) (Fig. 3b). For the auxiliary overlap ventilation system or piston flow the amount of air replaced after 1 hour at 1.0 air changes per hour (ACH) will theoretically be 100% (Bearg 1993). For the auxiliary ventilation setup using forcing or exhausting ducts or the short-circuiting flow, the amount of air actually replaced after 1 hour at 1.0 ACH will theoretically be less than 63% in the well-mixed case because the ventilated space becomes not just one zone but several, with differing zones receiving varying replacement rates (Bearg 1993).

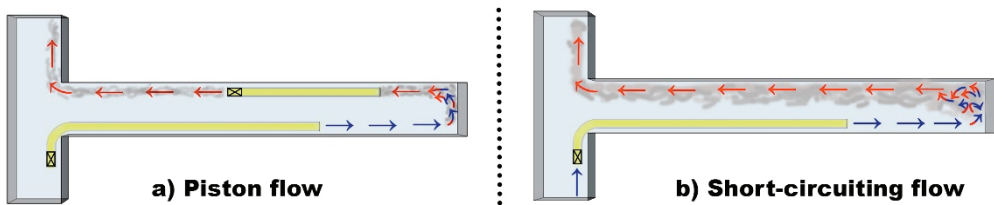

Fig. 3. Theoretical flows inside development heading used for age of air predictions

If we assume that the conditions in the development heading do not change (steady-state) then, the theoretical age for the air can be calculated using the following equation (Roulet 2008):

$$\tau_n = \frac{V}{Q} = \frac{1}{n}, \quad (1)$$

where:

τ_n is the shortest time air molecules spent in the development heading (nominal time constant) [min],

V – the volume of the development heading [m^3],

Q – air flow rate from the auxiliary ventilation system [m^3/s],

n – air change rate [air changes per hour].

This expression states that the time required for the air to ventilate a space is equal to the volume of the development heading, divided by the air flow rate from the auxiliary ventilation system.

The average time spent by the air with this theoretical estimate is expected to decrease as the flow rate of air going through the room increases. With overlap auxiliary ventilation system this nominal time constant τ_n , will have lower value because of the combine cooperation between the forcing and exhausting ducts.

The air change rate, which is the reciprocal of the nominal time constant τ_n , expresses the number of times the air volume in the development heading is changed in an hour.

For piston-flow the value for nominal time constant τ_n , can be shown to be less from the value for short-circuiting flow. According to the ASHRAE (1997), the formulation for calculating ACE can be express like:

$$ACE = \frac{\tau_n}{MAA}. \quad (2)$$

The values for ACE are normally determined by field or laboratory measurement. This can be restrictive, since some of the methods are very expensive and complicated. The evolution of CFD for flow field analysis provides an opportunity to apply ACE concepts at the design stage and improve the overall ventilation system.

3.3. MODEL FORMULATION

A three-dimensional model was developed to replicate a typical development heading in underground mine, as shown in Fig. 4. The creation of the 3D geometry, meshing and numerical modelling was carried out using the ANSYS Fluent software. The geometry of the development heading and the operating parameters of the auxiliary forcing ventilation system are shown in Fig. 4.

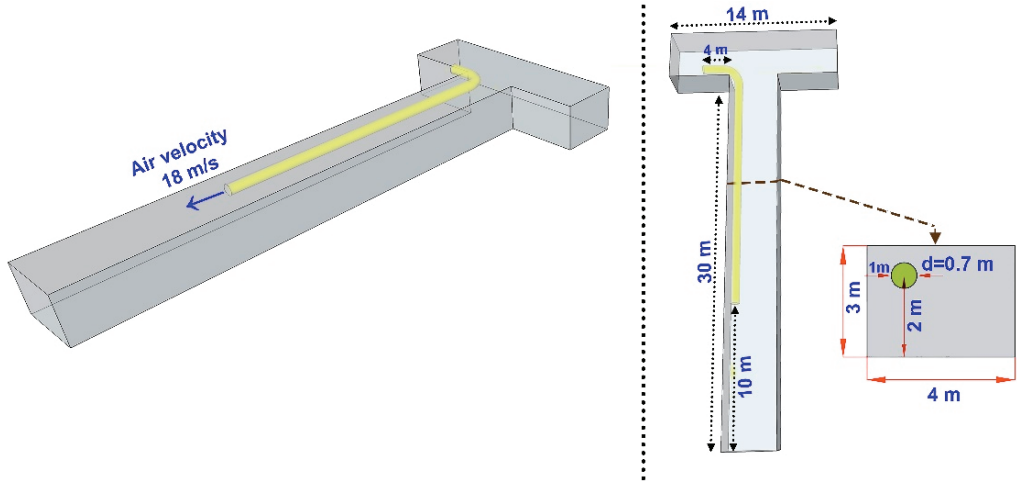

Fig. 4. Geometry and ventilation parameters of the model

In this paper were investigated three scenarios with the same geometry, operating parameters and computational characteristics, where calculations are made for ACE and MAA distribution inside empty development heading, ACE and MAA distribution in the breathing zone of the miner inside the development heading and ACE and MAA distribution inside development heading with LHD.

Mesh size was selected inside ANSYS Fluent software after performing mesh independence test and structured hexahedral mesh with a size of 0.04 m was created.

The used boundary conditions in the model are the following:

- At walls: the standard wall function;
- At the duct inlet: air velocity of 18 m/s;
- At the duct outlet: gauge pressure of 0 Pa;
- At the mine gallery outlet: gauge pressure of 0 Pa;
- Age of air: set to zero at the duct inlet.

This numerical simulations, were calculated using a second order scheme with convergence criterion in the order of 10^{-5} .

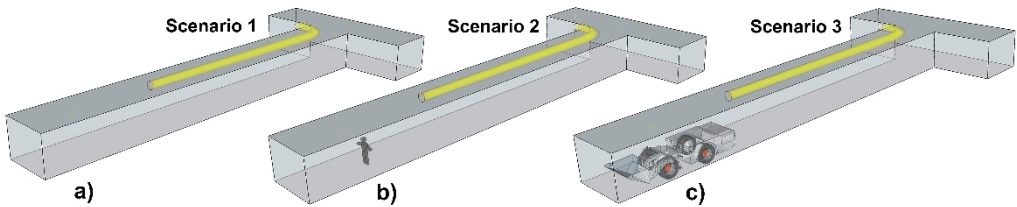

Fig. 5. Setup of the three scenarios that were considered in this analysis

In this paper the motion of fluid in the development heading follows principles of mass conservation, Newton's second law and the first law of thermodynamics. The numerical model used in this study is based on solving the three governing laws which are known as continuity equation, Navier–Stokes equation and energy equation, respectively (ANSYS Academic Research 2015):

$$\frac{\partial \rho}{\partial t} + \nabla \cdot (\rho V) = 0, \quad (3)$$

$$\rho \left(\frac{\partial V}{\partial t} + V \cdot \nabla V \right) = -\nabla p + \mu \nabla^2 V + F, \quad (4)$$

$$\rho \left(\frac{\partial E}{\partial t} + E \cdot \nabla E \right) = -K \nabla^2 T + W_s + S_E, \quad (5)$$

where ρ is the fluid density, t is time; $V = (V_x, V_y, V_z)$ is overall velocity vector of flow particle, ∇p is the pressure gradient, μ is viscosity of fluid, $F = (F_x, F_y, F_z)$ gravitational body force and external body forces, E is the energy of flow media, K is conductivity coefficient, W_s is the work done by the surface stresses and S_E represents energy supplied by source term.

The turbulence is simulated with the realizable $k - \varepsilon$ model because in previous researches has been found to be sufficient. This model considers of two-equation which solves for turbulent kinetic energy k , and its dissipation rate ε , which is coupled with turbulent viscosity. This model is given as (ANSYS Academic Research 2015):

$$\frac{\partial}{\partial t}(\rho k) + \frac{\partial}{\partial x_j}(\rho k u_j) = \frac{\partial}{\partial x_j} \left[\left(\mu + \frac{\mu_t}{\sigma_k} \right) \frac{\partial k}{\partial x_j} \right] + G_k + G_b - \rho \varepsilon - Y_M + S_k, \quad (6)$$

$$\begin{aligned} \frac{\partial}{\partial t}(\rho \varepsilon) + \frac{\partial}{\partial x_j}(\rho \varepsilon u_j) &= \frac{\partial}{\partial x_j} \left[\left(\mu + \frac{\mu_t}{\sigma_\varepsilon} \right) \frac{\partial \varepsilon}{\partial x_j} \right] \\ &+ \rho C_1 S \varepsilon - \rho C_2 \frac{\varepsilon^2}{k + \sqrt{\nu \varepsilon}} + C_{1\varepsilon} \frac{\varepsilon}{k} C_{3\varepsilon} G_b + S_\varepsilon, \end{aligned} \quad (7)$$

where:

$$C_1 = \max \left[0, 43, \frac{\eta}{\eta + 5} \right], \quad \eta = S \frac{k}{\varepsilon}, \quad S = \sqrt{2 S_{ij} S_{ij}}, \quad (8)$$

where: G_k is the generation of turbulence kinetic energy due to the mean velocity gradient, G_b represents the generation of turbulence kinetic energy due to buoyancy, Y_M is the contribution of the fluctuating dilatation in compressible turbulence to the overall dissipation rate, σ_k and σ_ε are the turbulent Prandtl numbers for k and ε , C_2 and $C_{1\varepsilon}$ are constants, S_k and S_ε are user-defined source terms, x_j is the axial coordinate and u_j is the axial velocity.

The value of MAA was calculated by solving the passive scalar transport equation in ANSYS Fluent software as follows (ANSYS Academic Research 2015):

$$\frac{\partial}{\partial x_j} \rho u_j \phi - \bar{J} \frac{\partial \phi}{\partial x_j} = \rho, \quad \bar{J} = -(\rho D_m + \rho D_t) \frac{\partial \phi}{\partial x_j}, \quad (9)$$

\bar{J} is the component of diffusion flux, D_m and D_t are molecular and turbulent diffusivity, $(\rho D_m + \rho D_t)$ is a turbulent Schmidt number and its value was assumed 0.7.

In ANSYS Fluent software there is not available model for calculating MAA, and because of this the equation is embedded in the CFD simulation by using user-defined functions (UDF) and then are compiled into executable functions in the solver (ANSYS FLUENT 12.0 UDF Manual, 2009) (Fig. 6).

There are five arguments to DEFINE_SOURCE: name, c , t , dS , and eqn . Supply name is the name of the UDF, c , t , dS , and eqn are variables that are passed by the ANSYS FLUENT solver to the UDF. There are four arguments to DEFINE_DIFFUSIVITY:

name, c , and t , and i . Supply name is the name of the *UDF*, c , t , and i are variables that are passed by the FLUENT solver to the UDF. The UDF will need to compute the diffusivity only for a single cell and return the real value to the solver.

<pre>#include "udf.h" DEFINE_SOURCE(rt_source,c,t,dS,eqn) { real source = C_R(c,t); dS[eqn] = 0.0; return source; } DEFINE_DIFFUSIVITY(rtd_diff, c, t, i) { return C_R(c,t)*2.88e-5+C_MU_EFF(c,t)/0.7; }</pre>	<p><i>* UDF to compute fluid residence time</i> <i>* At inlet, define UDS (value) = 0</i> <i>* UDS will have units of time and represent approximate residence time of fluid in domain</i> <i>* Diffusivity of scalar should be small to reduce diffusion i.e. 1E-5</i> <i>* Value of 2.88e-5 is used for the molecular diffusivity</i> <i>* Value of 0.7 is used for the turbulent Schmidt number</i></p>																		
<table border="0"> <thead> <tr> <th style="text-align: left;">Argument Type</th> <th style="text-align: left;">Description</th> </tr> </thead> <tbody> <tr> <td>symbol name</td> <td>UDF name.</td> </tr> <tr> <td>cell_t c</td> <td>Cell index.</td> </tr> <tr> <td>Thread *t</td> <td>Pointer to cell thread.</td> </tr> <tr> <td>int i</td> <td>Index that identifies the species or user-defined scalar.</td> </tr> <tr> <td>real dS[]</td> <td>Array that contains the derivative of the source term with respect to the dependent variable of the transport equation.</td> </tr> <tr> <td>int eqn</td> <td>Equation number.</td> </tr> <tr> <td colspan="2">Function returns</td> </tr> <tr> <td>real</td> <td></td> </tr> </tbody> </table>		Argument Type	Description	symbol name	UDF name.	cell_t c	Cell index.	Thread *t	Pointer to cell thread.	int i	Index that identifies the species or user-defined scalar.	real dS[]	Array that contains the derivative of the source term with respect to the dependent variable of the transport equation.	int eqn	Equation number.	Function returns		real	
Argument Type	Description																		
symbol name	UDF name.																		
cell_t c	Cell index.																		
Thread *t	Pointer to cell thread.																		
int i	Index that identifies the species or user-defined scalar.																		
real dS[]	Array that contains the derivative of the source term with respect to the dependent variable of the transport equation.																		
int eqn	Equation number.																		
Function returns																			
real																			

Fig. 6. UDF that computes diffusivity for MAA using a user-defined scalar

4. RESULTS AND DISCUSSION

4.1. NUMERICAL RESULTS

In this paper the performance of auxiliary forcing ventilation system in a development heading is examined in terms of ACE, where a total of three numerical simulation scenarios were performed under the same geometry, operating parameters and computational characteristics but with different setup (Fig. 5).

The simulation results are presented at two different planes shown in Figs. 7–9, to provide a complete understanding of the MAA in the development heading. The z - x cross-section planes represent the possible movement locations of the miners, and the x - y plane with $z = 1.6$ m, represent the possible breathing zone of the miners.

Simulation was first conducted for the case with empty development heading (Scenario 1, Fig. 5a). The MAA distribution indicates that the highest values are at the development face which is expected.

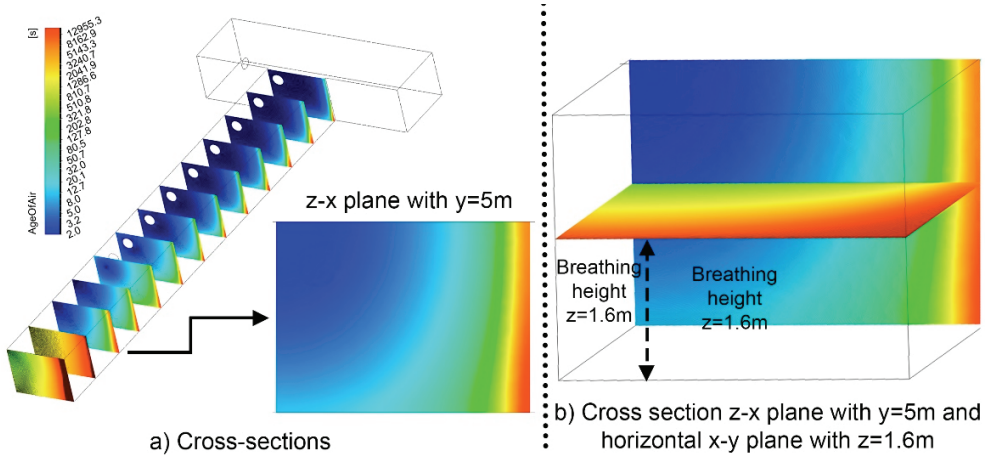

Fig. 7. Numerical simulation results for Scenario 1, at:
 a) possible movement locations of the miners and b) possible breathing zone of the miners

In Scenario 2 (Fig. 5b), due to the involvement of the miner we can notice minor changes in the airstream patterns that produces little changes in the MAA values that generated different ACE from Scenario 1, with 0.22% difference.

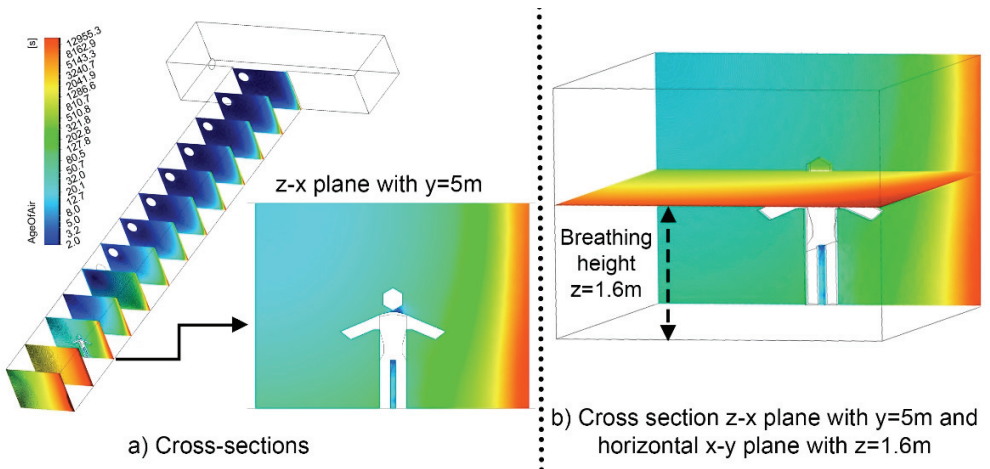

Fig. 8. Numerical simulation results for Scenario 2, at:
 a) possible movement locations of the miners and b) possible breathing zone of the miners

In Scenario 3 (Fig. 5c), the involvement of LHD generates very different air speed, airstream patterns and also significantly big change in the effective volume of the zone inside the development heading. This setup resulted in very different MAA and ACE values across the development heading as shown in Fig. 9.

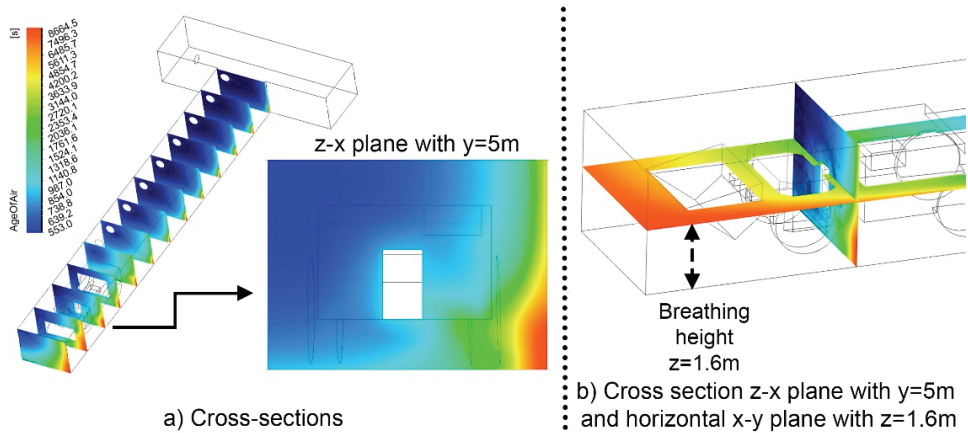

Fig. 9. Numerical simulation results for Scenario 3, at:

a) possible movement locations of the miners and b) possible breathing zone of the miners

Figures 10–13 illustrates the MAA in the cross sections of the possible movement locations of the miners with respect to their specific distance from the development heading face.

Results that are shown, explore various conditions that can occur in the mine development heading under the same ventilation operating parameters but different setup, and evaluates different airflow patterns that generate different results in the MAA values. The effective volume will be less than the gross development heading volume by the amount equal to the volume of the miner or the LHD. The different speed and movement of airflow patterns are expected due to the involvement of the miner and LHD in the development heading. The change in the effective volume of the zone inside the development heading in Scenario 3 (Fig. 5c), due to the involvement of LHD that do not completely obstruct the movement of air patterns resulted in higher result in the ACE and lower values in MAA. This phenomenon is due to the fact that the introduction of objects that reduce the effective volume of the zone inside the development heading results in a higher value of air changes per hour because this is related with the total volume of air in the zone that needs to be replaced (Hou et al. 2015). When calculating ACE for a space or zone, taking effective volume into consideration will have a significant effect on the result.

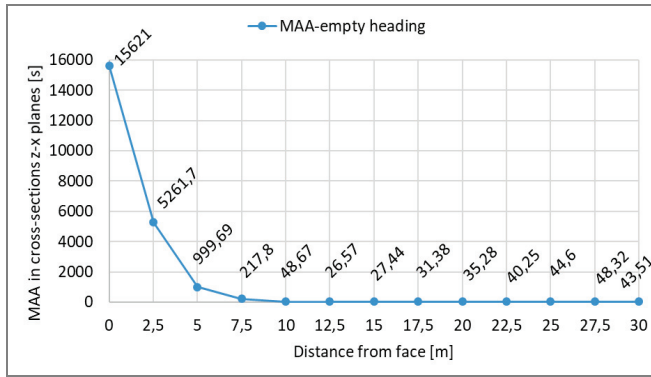

Fig. 10. MAA values in empty development heading at $z-x$ cross-sections planes with respect to their specific distance from the face

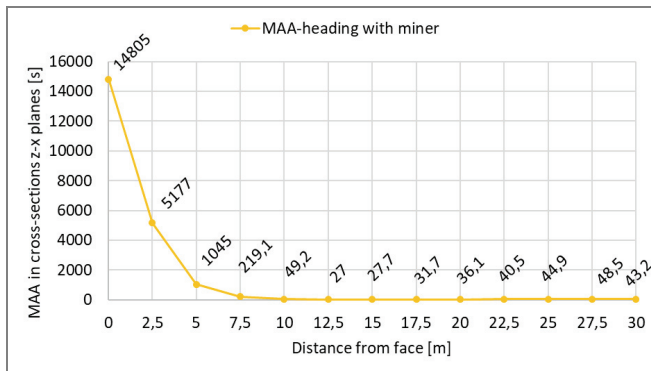

Fig. 11. MAA values in development heading with miner at $z-x$ cross-sections planes with respect to their specific distance from the face

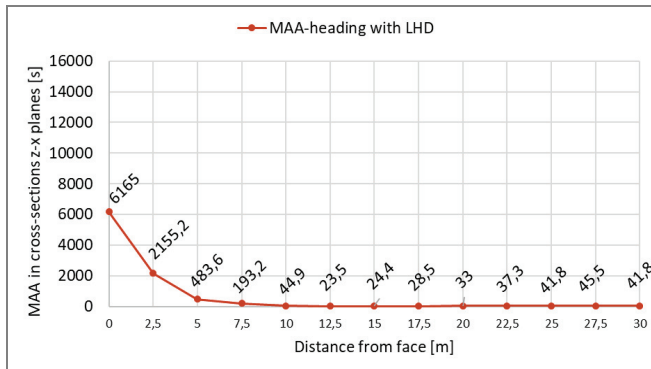

Fig. 12. MAA values in development heading with LHD at $z-x$ cross-sections planes with respect to their specific distance from the face

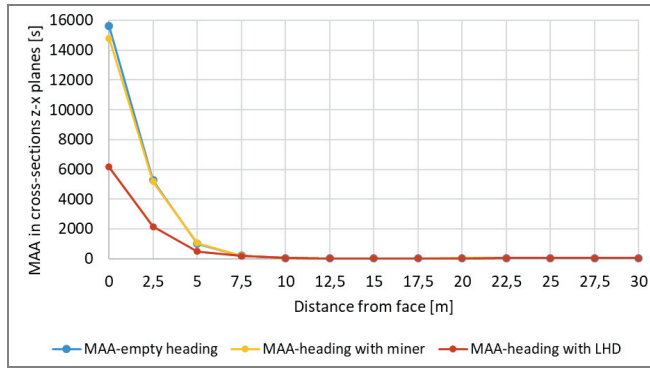

Fig. 13. MAA comparison values in development heading at z-x cross-sections planes with respect to their specific distance from the face

The numerical results are in accordance with this logical assumption in terms of this argument which is in favor of the presented methodology. MAA along the breathing height in the development heading are presented in Figs. 14–17.

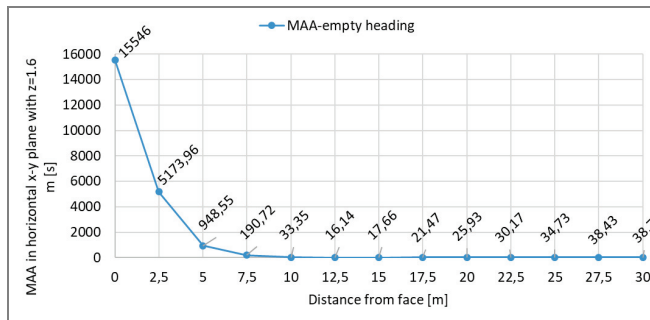

Fig. 14. MAA values in the breathing zone of empty development heading at x-y plane (z = 1.6) with respect to their specific distance from the face

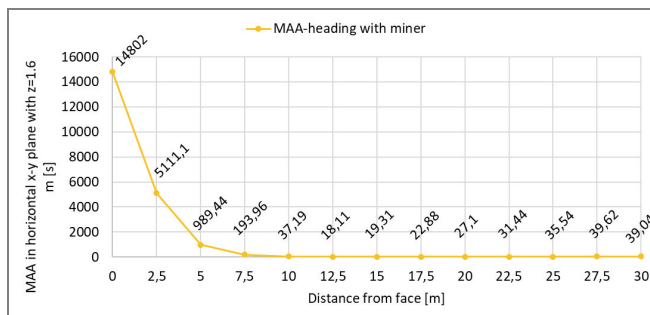

Fig. 15. MAA values in the breathing zone of development heading with miner at x-y plane (z = 1.6) with respect to their specific distance from the face

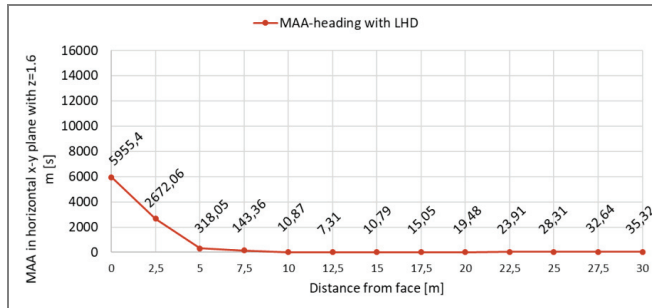

Fig. 16. MAA values in the breathing zone of development heading with LHD at x - y plane ($z = 1.6$) with respect to their specific distance from the face

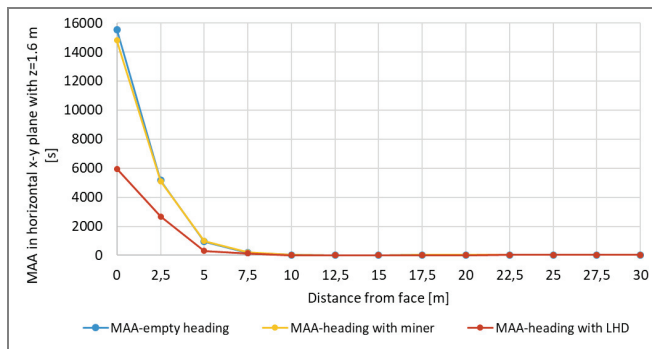

Fig. 17. MAA comparison values in the breathing zone of the development heading at x - y plane ($z = 1.6$) with respect to their specific distance from the face

With the scenarios presented, we managed to prove this relationship with the objects that can reduce the effective volume of the zone and the ACE. This positive change in ACE due the change in effective volume of the zone as we introduce objects is only possible if the objects do not block the airstream completely in the sense that the air can't reach to the development face (Fig. 18).

We have chosen simple scenarios from which we can make logical conclusions to make sure that we are on the right track with the methodology, before starting the validation process. The base model results must be validated against data from field measurements before accepting this quick, easy and inexpensive model for measuring ACE of the auxiliary forcing ventilation system in underground mines. Due to the extensiveness of the method the validation model with tracer gas technique will be scope of another study.

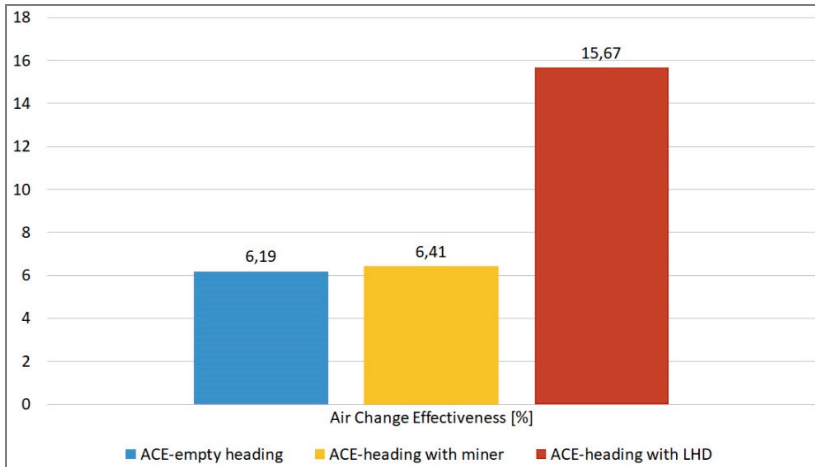

Fig. 18. ACE of the auxiliary forcing ventilation system inside the presented scenarios

5. CONCLUSION

CFD modelling has been conducted in this study to develop a method for determining ACE of the auxiliary forcing ventilation system in underground mines.

The value of MAA was calculated and simulated in order to characterize the ACE through the development heading in three scenarios under the same geometry, operating parameters and computational characteristics but with different setup.

Simulations provided detailed visual MAA patterns for understanding and calculating ACE. Modelling results show different speed and movement of airflow patterns due to the involvement of objects in the development heading. These objects reduce the effective volume of the zone and resulted in a higher value of air changes per hour because this is related with the total volume of air in the zone that needs to be replaced.

The change in the effective volume of the zone inside the development heading resulted in higher values in the ACE and lower values in MAA, but it needs to be stated that this is only possible if the objects do not block the airstream completely and reduce the airstream to reach the development face.

In addition this work highlights the concern for air quality inside underground mines and shows effort for making better work environment for the miners.

Furthermore, methodology for calculating the MAA using UDF inside ANSYS Fluent software was presented in this study.

Due to the complexity and the extensiveness of the validation model will remain to be presented in a different study, which is needed before accepting this methodology. Moreover, such studies are needed for constant improvement of working conditions inside underground mines.

ACKNOWLEDGEMENTS

This work was financially supported by the Faculty of Natural and Technical Sciences – Mining Engineering, “Goce Delchev” University, Shtip, Republic of Macedonia.

REFERENCES

- AMAI H., NOVOSELAC A., 2016, *Experimental study on air change effectiveness in mixing ventilation*, Building and Environment, Vol. 109, pp. 101–111, <https://doi.org/10.1016/j.buildenv.2016.09.015>.
- AMERICAN SOCIETY OF HEATING, REFRIGERATING AND AIR-CONDITIONING ENGINEERS, 1997, *ASHRAE handbook 1997: Fundamentals*, Chapter 25, Atlanta, pp. 492–520.
- ANSYS ACADEMIC RESEARCH., 2015, *ANSYS Fluent Theory Guide, Release 15.0, Help System*, Chapter 4, pp.39-177.
- ANSYS FLUENT 12.0, *UDF Manual, Release 12.0*, ANSYS, Inc., January 26, 2009, Chapter 2, pp. 37–273.
- BEARG D.W., 1993, *Indoor Air Quality and HVAC Systems*, Chapter4, Lewis Publishers, UK, pp. 61–81.
- BURATTI C., MARIANI R., MORETTI E., 2011, *Mean age of air in a naturally ventilated office: Experimental data and simulations*, Energy and Buildings, Vol. 43, Issue 8, pp. 2021–2027, <https://doi.org/10.1016/j.enbuild.2011.04.015>.
- DAGHIGH R., SOPIAN K., 2009, *The Impact of Air Exchange Effectiveness on Thermal Comfort in an Air-Conditioned Office*, American Journal of Applied Sciences, 6 (11), pp. 1973–1980.
- DE SOUZA E., 2004, *Auxiliary ventilation operation practices*, Proceedings of the 10th U.S., North American Mine Ventilation Symposium, Leiden, Netherlands: Balkema, pp. 341–348.
- FEDERSPIEL C., 1999, *Air-Change Effectiveness: Theory and Calculation Methods*, Indoor Air, 9, pp. 47–56.
- FISK W.J., FAULKNER D., SULLIVAN D., BAUMAN F., 1997, *Air change effectiveness and pollutant removal efficiency during adverse mixing conditions*, Indoor Air, Vol. 7, Issue 1, pp. 55–63.
- HAN H., CHOI S.H., LEE W.W., 2002, *Distribution of Local Supply and Exhaust Effectiveness according to Room Airflow Patterns*, International Journal of Air conditioning and Refrigeration, Vol. 10, No. 4, pp. 177–183.
- HOU J., SUN Y., KONG X., WANG P., ZHANG Q., SUNDELL J., 2015, *Single and Multiple Zone Methods to Calculate Air Change Rate in Apartments*, Procedia Engineering, Vol. 121, pp. 567–572, <https://doi.org/10.1016/j.proeng.2015.08.1035>.
- JONES P.J., WHITTLE G.E., 1992, *Computational fluid dynamics for building air flow prediction – current status and capabilities*, Building and Environment, Vol. 27, Issue 3, pp. 321–338, [https://doi.org/10.1016/0360-1323\(92\)90033-L](https://doi.org/10.1016/0360-1323(92)90033-L).
- MCPHERSON M.J., 1993, *Subsurface Ventilation and Environmental Engineering*, Chapman & Hall, London, pp. 21–25.
- MONTEIRO J., CASTRO O., 2014, *Comparison of Contaminant Removal Effectiveness and Air Change Efficiency as Indicator of Air Diffusion Quality*, The 13th International Conference on Indoor Air Quality and Climate at: Hong Kong, Vol. 4, pp. 392–400.
- NOVOSELAC A., SREBRIC J., 2003, *Comparison of air exchange efficiency and contaminant removal effectiveness as IAQ indices*, Transactions-American Society of Heating Refrigerating and Air Conditioning Engineers, Vol. 109, Issue 2, pp. 339–349.
- PADILLA-MARCOS M.Á., MEISS A., FEIJÓ-MUÑOZ J., 2017, *Proposal for a Simplified CFD Procedure for Obtaining Patterns of the Age of Air in Outdoor Spaces for the Natural Ventilation of Buildings*, Energies, Vol. 10, Issue 9, pp. 1252–1269, <https://doi.org/10.3390/en10091252>.
- ROULET C.A., 2008, *Ventilation and Airflow in Buildings: Methods for Diagnosis and Evaluation*, Chapter 4, Earthscan, UK, pp. 39–49.

- SANDBERG M., 1981, *What is Ventilation Efficiency*, Building and Environment, Vol. 16, No. 2, pp. 123–135.
- STOKES A.W., KENNEDY D.J., HARDCASTLE S.G., 1987, *A real-time tracer gas analyzer – an investigational tool for mine ventilation studies*, Mining Science and Technology, Vol. 5, Issue 2, pp. 187–196, [https://doi.org/10.1016/S0167-9031\(87\)90405-1](https://doi.org/10.1016/S0167-9031(87)90405-1).
- TOMASI R., KRAJČÍK M., SIMONE A., OLESEN B.W., 2013, *Experimental evaluation of air distribution in mechanically ventilated residential rooms: Thermal comfort and ventilation effectiveness*, Energy and Buildings, Vol. 60, pp. 28–37, <https://doi.org/10.1016/j.enbuild.2013.01.003>.
- WIDIATMOJO A., SASAKI K., MATSUMURA M., SUGAI Y., 2014, *Laboratory Experiment of Air Residence Time in a Side Rectangular Cavity*, Advanced Chemical Engineering Research, Vol. 3, pp. 27–33.
- XIANTING L., DONGNING L., CHUNPENG D., 2003a, *An algorithm for calculating fresh air age in central ventilation system*, Science in China Series E: Technological Sciences, Vol. 46, Issue 2, pp. 182–190, <https://doi.org/10.1007/BF03039577>.
- XIANTING L., DONGNING L., XUDONG Y., JIANRONG Y., 2003b, *Total air age: an extension of the air age concept*, Building and Environment, Vol. 38, Issue 11, pp. 1263–1269, [https://doi.org/10.1016/S0360-1323\(03\)00133-1](https://doi.org/10.1016/S0360-1323(03)00133-1).
- XING H., HATTON A., AWBI H.B., 2001, *A study of the air quality in the breathing zone in a room with displacement ventilation*, Building and Environment, Vol. 36, Issue 7, pp. 809–820, [https://doi.org/10.1016/S0360-1323\(01\)00006-3](https://doi.org/10.1016/S0360-1323(01)00006-3).