

PV installations and the safety of residential buildings

Konrad SEKLECKI¹, Leszek S. LITZBARSKI*¹, Marek ADAMOWICZ¹, Jacek GROCHOWSKI²

¹ *Faculty of Electrical and Control Engineering, Gdansk University of Technology, Narutowicza 11/12, 80-233 Gdansk, Poland*

² *Faculty of Control, Robotics and Electrical Engineering, Poznan University of Technology, Marii Skłodowskiej-Curie 5, 60-965 Poznań, Poland*

Abstract

The dynamic development of the photovoltaic industry entails threats that have a direct impact on the safety of residential buildings. Appropriate design of a PV installation can be a challenge due to the multifaceted nature of this issue. The designer should take into account issues related to the selection of electrical parameters of the installation, adapting lightning and surge protection in accordance with applicable standards, ensure the optimization of the system in terms of efficiency and fire safety and calculate the mechanical stress on the rooftop. Unfortunately, most PV installations in Poland are built without any engineering project, which is allowed by the current law. In this article, we describe the results of simulations of real mechanical loads inflicted from the installation of PV panels on flat roofs for various regions of Poland. We also present the results of the simulation of the thermal impact of hot-spots on the roof surface, which can be a potential source of fire. In addition, we propose changes to the regulations that may increase the safety of PV installations mounted on the roofs of residential buildings.

Keywords: photovoltaics, PV installations, safety of constructions, mechanical load calculations, thermal impact simulations

1 Introduction

In recent years, a rapid development of the photovoltaic industry can be observed both in Poland and in other countries, which is determined by the desire to reduce CO₂ emissions in order to stop the climate changes. Photovoltaics becomes one of the most popular renewable energy sources due to an increase of the efficiency of silicon based PV panels and an extension of their lifetime. In Poland, at the beginning of 2023, the total power of photovoltaic systems exceeded 12.5 GW, with the dominant share of low-power installations [1]. The burden of the energy transformation in Poland has been shifted to individual consumers, who are encouraged to invest in PV systems with government subsidies financed e.g. under the *Mój Prąd* program [2]. This solution allows to reduce

* **Corresponding author:** E-mail address: (leszek.litzbarski@pg.edu.pl) Leszek S. LITZBARSKI

electricity costs incurred by individual customers, however, it is associated with the emergence of new threats to residential buildings such as an increase of fire risk [3], [4], [5]. It should be mentioned, that PV systems are characterized by a high level of safety when they are designed and manufactured in accordance with applicable technical standards [6]. Unfortunately, the regulations in Poland assume the need to prepare a construction project only in the case of installations with a power exceeding 50 kW [7], which exclude most of PV systems mounted on residential buildings. Although the amendment to the regulations imposed an obligation to agree in terms of compliance with fire protection requirements in the case of installations with a capacity above 6.5 kW, there are still other aspects affecting the safety of using such systems. Designing a photovoltaic installation requires extensive knowledge in various fields, as it shown in Fig. 1.

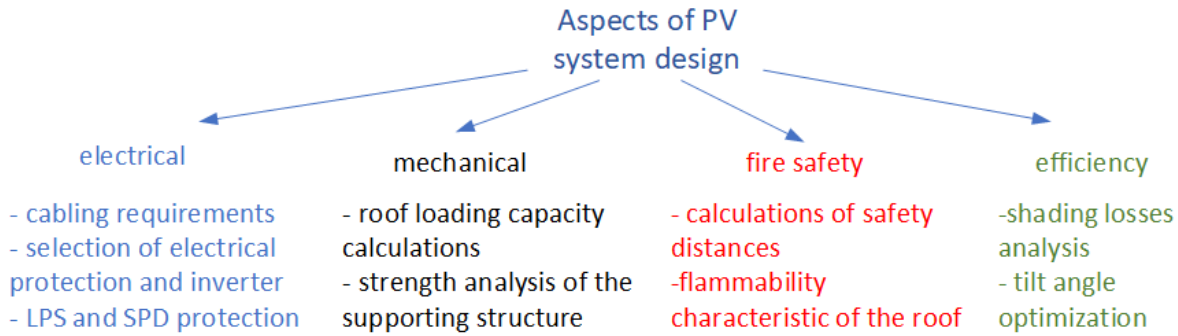

Figure 1. Different aspects of PV systems design

Issues related to the selection of electrical components [8], [9], [10], [11] and lightning protection of PV installations [12], [13], [14], [15] have been described in detail in the literature. The issue of optimizing the efficiency of PV systems was also an object of specific investigations [16], [17], [18], [19]. For this reason, this article focuses on mechanical aspects of PV systems design and issues related to fire safety.

2 Mechanical issues

Photovoltaic panels are mounted on special supporting structures that must guarantee their permanent connection with the roof regardless of weather conditions. There are two types of commonly used flat roof mounting systems for PV panels: a non-intrusive ballast system, in which the panels are held on the roof by weights such as concrete blocks, and an invasive system using screws tighten into the roof (see Fig.2).

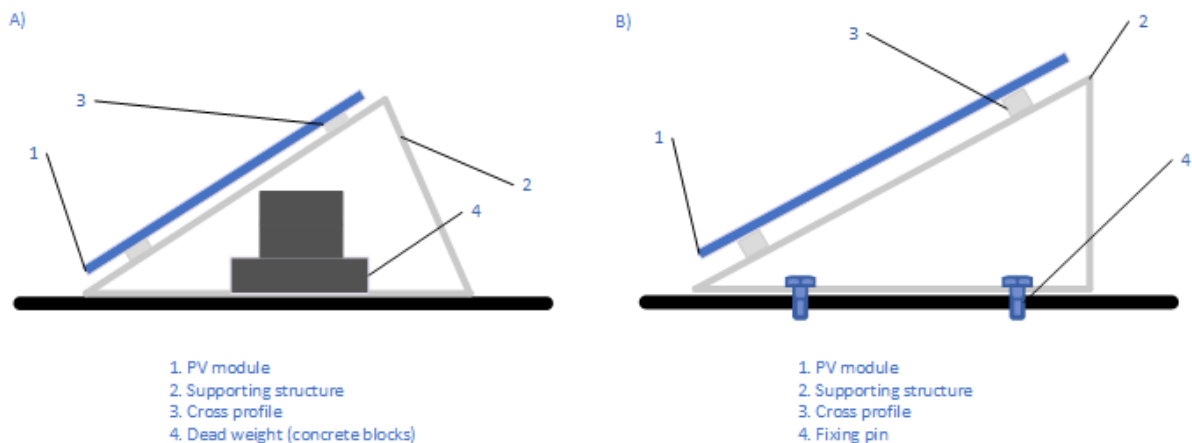

Figure 2. Flat-roof mounting systems for PV modules: ballast (A) and anchor (B) system

The first type of assembly does not affect the tightness of the rooftop, but generates significant loads on its construction. The second method can be used only when the roof surface allows for solid anchoring of the fastening screws. Pitched roofs, due to the different techniques of execution (metal tiles, trapezoidal sheet, ceramic or concrete tiles, etc.), have a variety of fastening systems adapted to specific cases. However, when choosing a system for fixing PV modules to the roof, the total load associated with the installation should be taken into account. It should be noted that inclusion of a permanent load (Q_p) related to the weight of the PV modules is not sufficient, due to impact of dynamical component i.e. wind loading. The action of wind on construction is usually described by a peak velocity pressure at a height z . This parameter can be estimated employing the equation defined in the PN-EN 1991-1-4:2008 standard:

$$q_p(z) = c_e(z) \cdot q_b,$$

where $c_e(z)$ stands for an exposure factor, which is dependent to the landform and q_b is a basic velocity pressure. Following the national appendix to PN-EN 1991-1-4:2008 standard there are three wind zones in Poland, which differ in the method of calculating q_b . Another important factor is the snow load (S), which can be estimated using the equation from the PN-EN 1991-1-3:2005 standard:

$$S = \mu \cdot C_e \cdot C_t \cdot S_k$$

where μ is coefficient dependent of the shape of the roof, C_e is an exposure coefficient, C_t means thermal coefficient and S_k is the characteristic snow load value on the ground. The Polish annex to the PN-EN 1991-1-3:2005 standard distinguishes 5 snow load zones, which are characterized by individual equations for S_k parameter calculations. For the purposes of this article, we defined the maximum real load (Q_r) of the PV module as:

$$Q_r = Q_p + A \cdot (S + q_p(z)),$$

where A is a surface area of the module.

In order to calculate the actual load generated by the PV modules, simulations were carried out using Autodesk Inventor software. The calculations were made for the PV module mounted on the structure, which dimensions are shown in Fig. 3. There were selected ten Polish cities located in different wind and snow load zones, for which values of $q_p(z)$ and S are gathered in Table 1. It is worth to note, that the above parameters for many other Polish cities (e.g. Poznań, Toruń, Bydgoszcz, Gorzów) will be similar to the values for Warsaw.

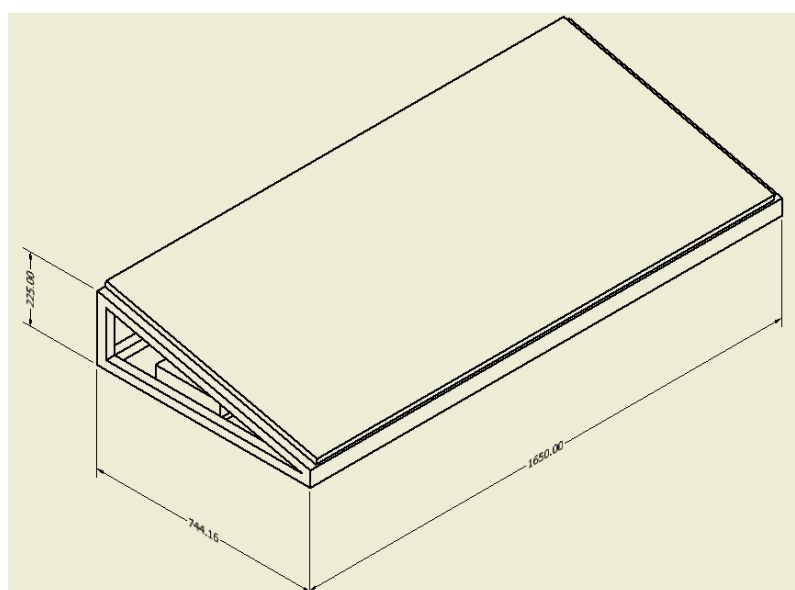

Figure 3. Dimensions of the supporting structure used in total load simulations

Table 1. Values of q_b and S_k parameters for selected cities in Poland

City	q_b [kN/m ²]	S_k [kN/m ²]
Białystok	0.3	1.6
Gdańsk	0.42	1.2
Kielce	0.34	1.85
Kraków	0.33	1.7
Lublin	0.3	1.2
Opole	0.3	0.7
Szczecin	0.42	0.9
Warszawa	0.3	0.9
Zakopane	0.55	3.55

There were chosen the following values for other variables:

- $C_e = 1$ - normal terrain, i.e. on which there is no significant wind transport of snow to buildings;
- $C_t = 1$ – a typical value for common roofs;
- $\mu = 0.8$ – determined by the tilt angle, which is equal 13° in the investigated case;
- $c_e(z) = 1.5(z/10)^{0.29} = 1.5$ – this parameter was calculated employing the formula typical for IV category of terrain (an urban region). The height of the supporting structure placed on the roof, calculated from the ground was fixed at $z = 10$ m.

The obtained results are presented in Fig. 4A, which exhibit a relative increase in the load on the supporting structure for the investigated cases, which can be defined as $\delta_Q = (Q_r - Q_p)/Q_p$.

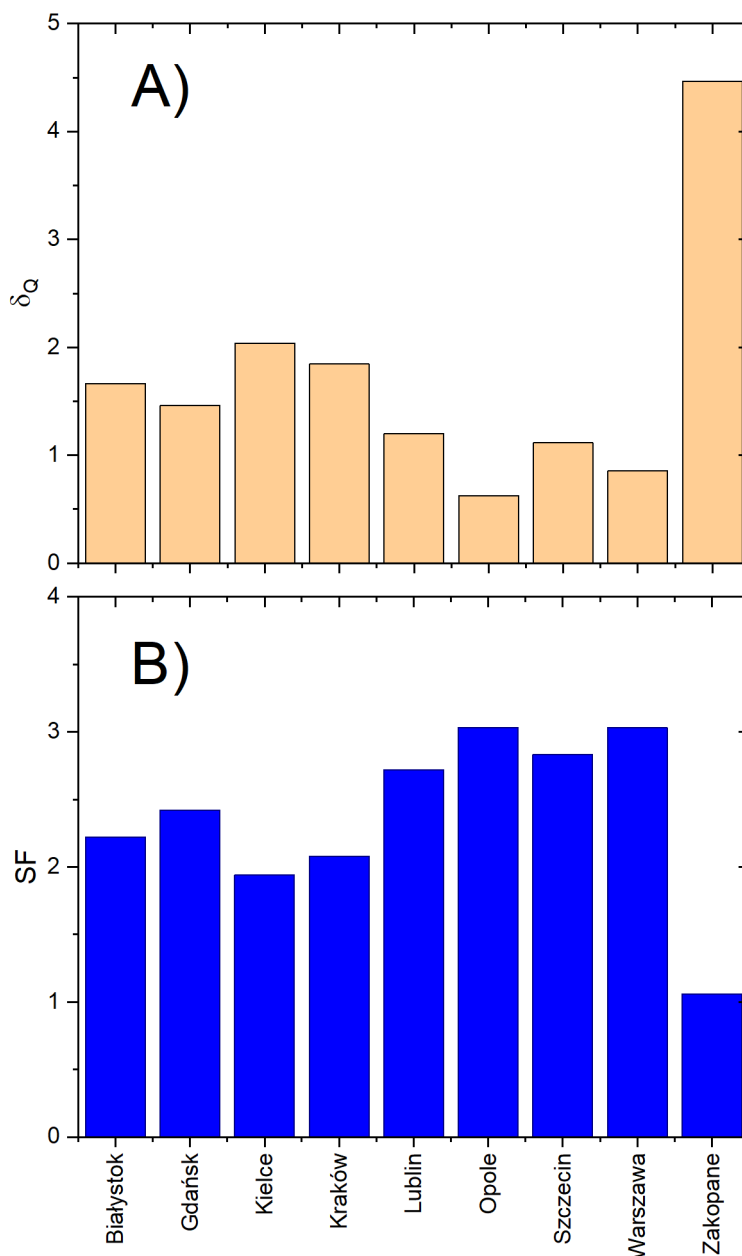

Figure 4. The relative increase in the load on the supporting structure of PV module (A) and the factor of safety (B) in a various conditions

It is clearly visible, that the largest increase of total load can be observed for objects located in mountainous regions, which is the result of the coexistence of high wind and snow loads. The calculated value of this coefficient is more than seven times larger than the lowest obtained result (for Opole city) and about 2.5 times larger than average value, which is equal 1.81 MPa. It is worth noting that the lowest estimated value of the real load is about 63% higher than the static load. The above results show how important it is to consider the real load when designing a PV installation. The impact of PV installations on the structure of the building should be taken into account for the safety of their exploitation.

For safety reasons, the strength of the supporting structure on which the PV panels will be installed should also be checked. Falling PV modules from the roof can cause significant material damage or death to people in the vicinity of the building, thus it is important to fix them properly. The crucial meaning has a strength of the supporting structure, which may be described by a factor of safety (SF) [20]:

$$SF = \sigma_{\text{yield}} / \sigma_{\text{working}},$$

where σ_{yield} means a dangerous stress value and σ_{working} is a maximum allowable stress value. This parameter determines how much more powerful the system is than necessary for the intended load. If its value is less than 1, the structure may collapse. Fig. 4B exhibits values of SF for the investigated supporting structure in a various conditions. For some cases, the estimated safety factors are close to the reference value (without external load) and are equal about 3. However, the increase in the load on the structure causes a noticeable decrease in SF to the vicinity of the limit value that was denoted for the city of Zakopane. Another parameter describing the reaction of the structure to mechanical loads is a maximum displacement, which should not exceed the limit value for the investigated system. In Fig. 5 shown the maximum displacement of PV module under a permanent load and a maximum real load for Zakopane city. The deformation of the PV panel, which is not affected by external forces, is negligibly small, while in the latter case, a displacement of more than 15 mm is observed. The coexistence of snow and wind loads causes a significant strain of the module, which can leads to its damage. PV panels are sensitive to mechanical damage [21], so when installing them in regions with increased exposure to weather conditions, the supporting structure should be properly selected.

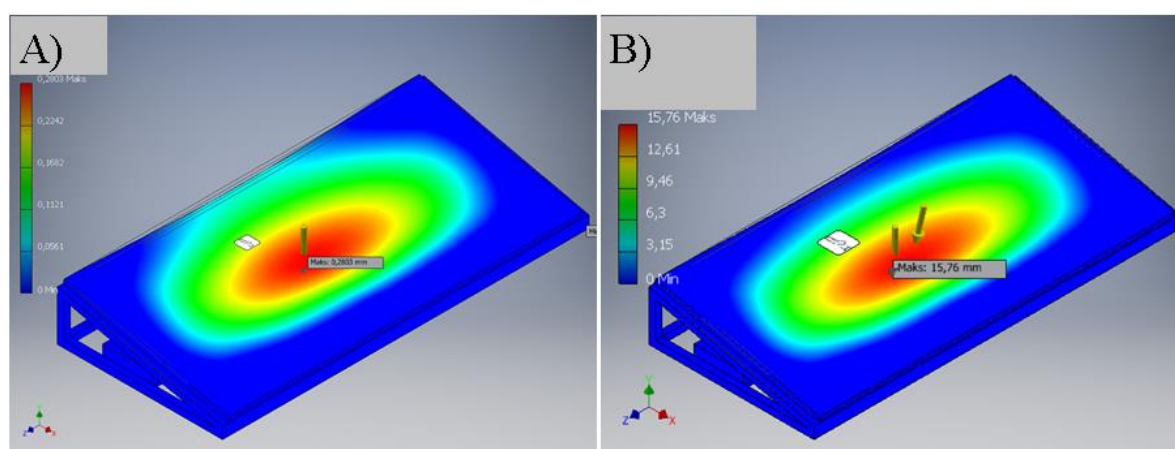

Figure 5. The maximum displacement of PV module under a permanent load (A) and a maximum real load for Zakopane city (B)

3 Heat impact simulations

Mechanical damage to PV panels is one of the causes of the so-called hot spot phenomena, which lead to the heating of the panel up to 250 °C [22]. This effect occurs when a one cell from a series is negatively biased and dissipates power as a heat instead of producing electricity [23]. Hot - spot formation can be also a result of a partial shading of the module surface e.g. by birds droppings and its consequence may be damage or even self-ignition of the module [24]. It is also known that this phenomenon can lead to overheating of the rooftop [25]. The heat impact of PV panels on rooftop was simulated employing FEMM software, which is a widely used tool for science and engineering purposes [26]. The calculations were made for a standard silicon PV module with a glass cover, a fiberglass based composite backsheet and an aluminum frame. The first experiment consisted in introducing a single hot-spot with dimensions of 20 x 1.5 mm and a temperature of 250 °C into the investigated panel and checking the temperature distribution on the rooftop. Obtained results are presented in Fig. 6, which exhibits an impact on the roof of PV panels mounted with and without a supporting structure (an aluminum profile with dimensions 30x30 mm). It is obvious that moving the heat source away from the surface will reduce its temperature, however, the scale of this phenomenon in the studied case is noteworthy. The use of a supporting structure causes the maximum temperature on the roof surface to drop by more than 25°C and the heat affected zone shrinks by about 66%. In real conditions, this effect may be even greater due to the free flow of air under the PV panel, which was not taken into account in the simulation.

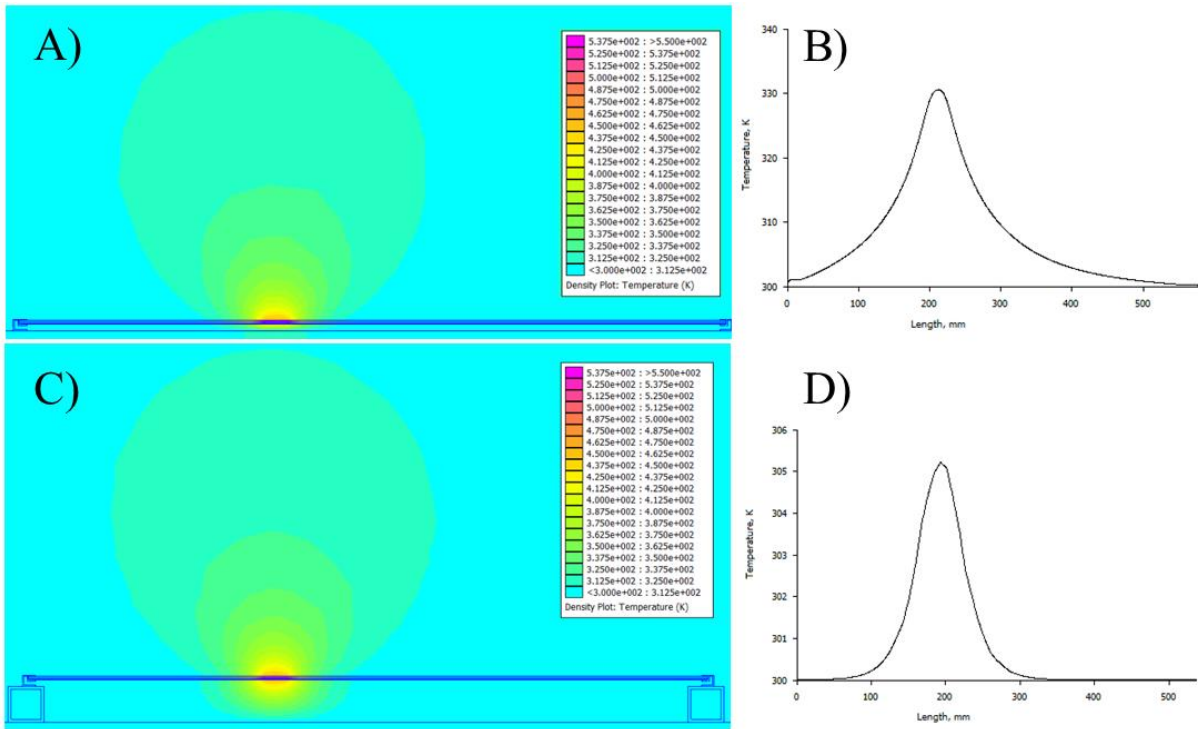

Figure 6. The thermal impact of PV panels on roof: without (A, B) and with (C, D) a supporting structure

Another experiment was to investigate the effect of multiple hot spots on the temperature distribution on the roof surface. Such a phenomenon may, for example, occur in the case of polluted or damaged by hail PV modules. Figure 7 shows the temperature distribution for a PV module with several hot spots and a plot of the relationship between the temperature on the roof surface and the distance from the corner of this panel. In this case, the temperature increase is about 20% greater than for a single hot spot and it covers a much wider area. The above experiments clearly show that the hot spot phenomenon contributes to the heating of the roof surface, which has a negative influence on a building cooling load.

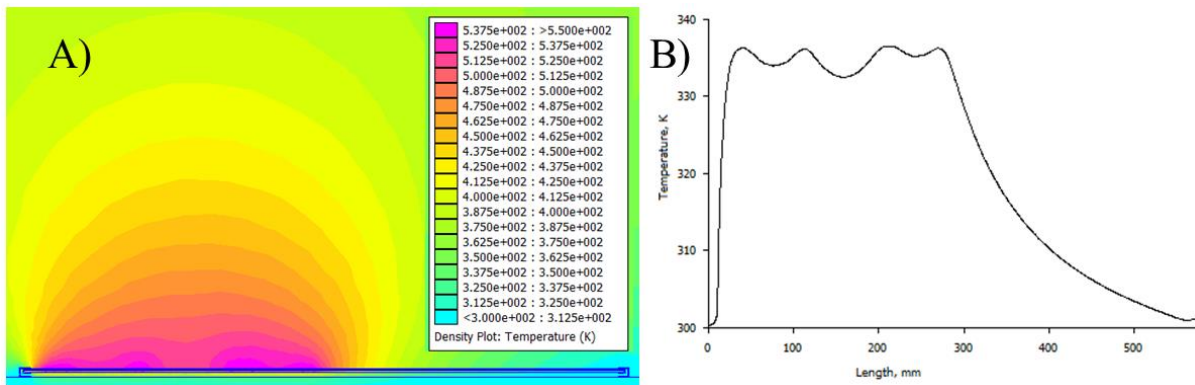

Figure 7. The multi hot-spot effect impact on the roof temperature: A) results of the simulation, B) the rooftop temperature distribution

4 Safety distances

Fire Protection Association recommends keeping the appropriate safety distances that will enable effective firefighting [5]. There are suggestions in the literature, that the minimal distance from the edge of the roof should not be less than 1 m [27]. It should be also mentioned that PV panels can be classified as combustible materials due to the components from which they are made [28]. For this reason, PV modules should be installed far away from the

sources of hot gases or vapors e.g. chimneys. Furthermore, the products of their combustion are extremely toxic [29], therefore they should not be close to the air intakes of the building. Smoke entering the ventilation system during a fire could make it difficult to evacuate the occupants [30]. In Fig. 8 is depicted an example of the arrangement of PV panels on the roof of a residential building. The hatched areas are free of PV panels due to safety reasons. Unfortunately, the regulations in force in Poland do not regulate the issue of safety distances, which is why many PV installations are not made in accordance with the above rules. Striving to maximize the power generated by the PV system, it covers the entire available roof surface without any analysis of safety issues.

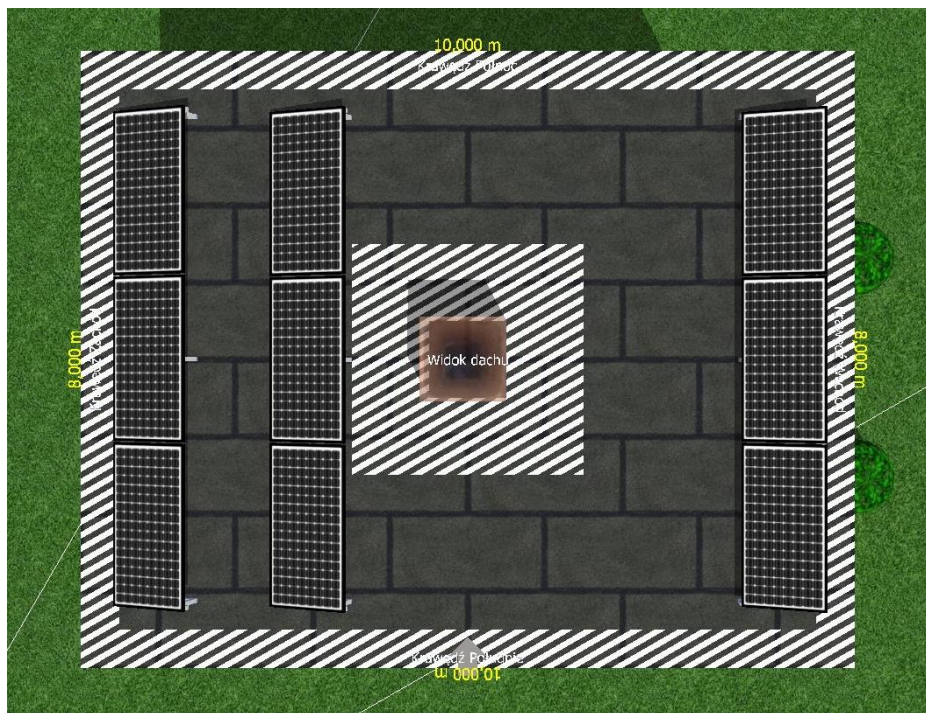

Figure 8. An example of the arrangement of PV panels on the roof of a residential building. The hatched areas correspond to the safety distances

5 Conclusions

Designing PV installations is a multi-faceted issue, therefore it should be entrusted to professionals with appropriate knowledge and experience in the renewable energy sector. The designer should take into account issues related to the selection of electrical parameters, lightning protection, efficiency, fire safety and mechanical strength. Negligence in this matter may have a significant impact on reducing the operational safety of the facility, even in the case of low-power installations mounted on residential buildings. The real load on the building structure with PV modules is, depending on the region of Poland, from about 63% to 450% higher than it would result from the permanent load. In addition, an improperly selected support structure may not ensure adequate transfer of stresses resulting from external forces. Direct installation of PV modules on the roof of the building is not recommended due to the possibility of heating its surface as a consequence of a hot spot effect. For fire safety reasons, safety distances should also be taken into account, which will enable the firefighting operation to be carried out efficiently. It is also important that the PV modules are not located near vents and sources of heat and pollution such as chimneys.

Bibliography

- [1] “<https://www.rynekelektryczny.pl/moc-zainstalowana-fotowoltaiki-w-polsce/>.”
- [2] J. Cader, P. Olczak, and R. Koneczna, “Regional dependencies of interest in the ‘My Electricity’ photovoltaic subsidy program in Poland,” *Polityka Energ. – Energy Policy J.*, vol. 24, no. 2, pp. 97–116, 2021, doi:

10.33223/epj/133473.

- [3] N. A. F. Mohd Nizam Ong, M. Z. Mohd Tohir, M. M. Mutlak, M. A. Sadiq, R. Omar, and M. S. Md Said, "BowTie analysis of rooftop grid-connected photovoltaic systems," *Process Saf. Prog.*, vol. 41, no. S1, pp. S106–S117, Apr. 2022, doi: <https://doi.org/10.1002/prs.12338>.
- [4] M. C. Falvo and S. Capparella, "Safety issues in PV systems: Design choices for a secure fault detection and for preventing fire risk," *Case Stud. Fire Saf.*, vol. 3, pp. 1–16, 2015, doi: <https://doi.org/10.1016/j.csfs.2014.11.002>.
- [5] N. A. F. Mohd Nizam Ong, M. Z. Mohd Tohir, M. S. Md Said, M. S. Nasif, A. H. Alias, and M. R. Ramali, "Development of fire safety best practices for rooftops grid-connected photovoltaic (PV) systems installation using systematic review methodology," *Sustain. Cities Soc.*, vol. 78, p. 103637, 2022, doi: <https://doi.org/10.1016/j.scs.2021.103637>.
- [6] P. Czaja, "Bezpieczeństwo pożarowe instalacji fotowoltaicznych," *SUMA*, vol. 150, p. 836, 2021.
- [7] P. Budowlane, "Ustawa z dnia 7 lipca 1994 r.," *Prawo Bud. jednolity, Dz. U2010 Nr 243 poz. 1632 z późniejszymi zmianami*, 2018.
- [8] K. Seklecki and M. Olesz, "Zasady montażu instalacji fotowoltaicznych według obowiązujących przepisów i norm," *Zesz. Nauk. Wydz. Elektrotechniki i Autom. Politech. Gdańskiej*, 2021.
- [9] G. Trzmiel and M. W. Kesierska, "Kryteria doboru przewodów w instalacjach fotowoltaicznych," *Pozn. Univ. Technol. Acad. Journals. Electr. Eng.*, no. 89, pp. 425–433, 2017.
- [10] M. Pilinski, "Optymalny dobór falownika do instalacji PV," *GLOBEnergia: Odnawialne Źródła Energii*, no. 2, 2018.
- [11] T. Koźbiał, "Generatory fotowoltaiczne w kontekście doboru elementów składowych oraz ochrony przeciwpożarowej," *Przeł{\k{a}}d Elektrotechniczny*, no. 96, 2019.
- [12] H. Boryń, "Ochrona odgromowa fotowoltaicznych źródeł energii elektrycznej," *Zesz. Nauk. Wydz. Elektrotechniki i Autom. Politech. Gdańskiej*, pp. 21–26, 2010.
- [13] E. Sobieska and K. Sobolewski, "Modelowanie i symulacje instalacji ochrony odgromowej dla obiektów wyposażonych w instalację fotowoltaiczną," *Przeł{\k{a}}d Elektrotechniczny*, vol. 97, no. 6, pp. 86–90, 2021.
- [14] D. Głuchy, D. Kurz, and G. Trzmiel, "Instalacja odgromowa i ograniczniki przepięć w instalacjach fotowoltaicznych," *Pozn. Univ. Technol. Acad. Journals. Electr. Eng.*, 2015.
- [15] L. Litzbarski, M. Olesz, K. Seklecki, and M. Nowak, "Ryzyko strat odgromowych a systemy fotowoltaiczne," *Przeł{\k{a}}d Elektrotechniczny*, pp. 293–295, 2023.
- [16] M. Almaktar, H. A. Rahman, and M. Y. Hassan, "Effect of losses resistances, module temperature variation, and partial shading on PV output power," in *2012 IEEE International Conference on Power and Energy (PECon)*, 2012, pp. 360–365, doi: [10.1109/PECon.2012.6450238](https://doi.org/10.1109/PECon.2012.6450238).
- [17] A. DJALAB, N. BESSOUS, M. M. REZAOUI, and I. MERZOUK, "Study of the Effects of Partial Shading on PV Array," in *2018 International Conference on Communications and Electrical Engineering (ICCEE)*, 2018, pp. 1–5, doi: [10.1109/CCEE.2018.8634512](https://doi.org/10.1109/CCEE.2018.8634512).
- [18] A. M. Ajmal, T. Sudhakar Babu, V. K. Ramachandaramurthy, D. Yousri, and J. B. Ekanayake, "Static and dynamic reconfiguration approaches for mitigation of partial shading influence in photovoltaic arrays," *Sustain. Energy Technol. Assessments*, vol. 40, p. 100738, 2020, doi: <https://doi.org/10.1016/j.seta.2020.100738>.
- [19] F. Bayrak and H. F. Oztop, "Effects of static and dynamic shading on thermodynamic and electrical performance for photovoltaic panels," *Appl. Therm. Eng.*, vol. 169, p. 114900, 2020, doi: <https://doi.org/10.1016/j.applthermeng.2020.114900>.

<https://doi.org/10.1016/j.applthermaleng.2020.114900>.

- [20] T. Domański, “Współczynniki bezpieczeństwa łączników sworzniowych w belkach zespolonych,” *Zesz. Nauk. Politech. Rzesz. Bud. i Inżynieria Środowiska*, vol. z. 50 [256, pp. 55–62, 2008.
- [21] S. Kajari-Schröder, I. Kunze, U. Eitner, and M. Köntges, “Spatial and orientational distribution of cracks in crystalline photovoltaic modules generated by mechanical load tests,” *Sol. Energy Mater. Sol. Cells*, vol. 95, no. 11, pp. 3054–3059, 2011, doi: <https://doi.org/10.1016/j.solmat.2011.06.032>.
- [22] M. Simon and E. L. Meyer, “Detection and analysis of hot-spot formation in solar cells,” *Sol. Energy Mater. Sol. Cells*, vol. 94, no. 2, pp. 106–113, 2010.
- [23] E. Molenbroek, D. W. Waddington, and K. A. Emery, “Hot spot susceptibility and testing of PV modules,” in *The Conference Record of the Twenty-Second IEEE Photovoltaic Specialists Conference - 1991*, 1991, pp. 547–552 vol.1, doi: 10.1109/PVSC.1991.169273.
- [24] F. Bayrak and H. F. Oztop, “Effects of static and dynamic shading on thermodynamic and electrical performance for photovoltaic panels,” *Appl. Therm. Eng.*, vol. 169, p. 114900, 2020, doi: <https://doi.org/10.1016/j.applthermaleng.2020.114900>.
- [25] B. Moshfegh and M. Sandberg, “Flow and heat transfer in the air gap behind photovoltaic panels,” *Renew. Sustain. Energy Rev.*, vol. 2, no. 3, pp. 287–301, 1998, doi: [https://doi.org/10.1016/S1364-0321\(98\)00005-7](https://doi.org/10.1016/S1364-0321(98)00005-7).
- [26] K. B. Baltzis, “The FEMM Package: A Simple, Fast, and Accurate Open Source Electromagnetic Tool in Science and Engineering.,” *J. Eng. Sci. & Technol. Rev.*, vol. 1, no. 1, 2008.
- [27] A. Iringova, “Location of Photovoltaic Panels in the Building Envelope in Terms of Fire Safety,” *Civ. Environ. Eng.*, vol. 18, no. 2, pp. 523–531, 2022, doi: [doi:10.2478/cee-2022-0050](https://doi.org/10.2478/cee-2022-0050).
- [28] X. Ju *et al.*, “Impact of flat roof–integrated solar photovoltaic installation mode on building fire safety,” *Fire Mater.*, vol. 43, no. 8, pp. 936–948, Dec. 2019, doi: <https://doi.org/10.1002/fam.2755>.
- [29] B. Liao, L. Yang, X. Ju, Y. Peng, and Y. Gao, “Experimental study on burning and toxicity hazards of a PET laminated photovoltaic panel,” *Sol. Energy Mater. Sol. Cells*, vol. 206, p. 110295, 2020, doi: <https://doi.org/10.1016/j.solmat.2019.110295>.
- [30] L. Mazziotti, P. Cancelliere, G. Paduano, P. Setti, and S. Sassi, “Fire risk related to the use of PV systems in building facades,” *MATEC Web Conf.*, vol. 46, p. 5001, Jan. 2016, doi: 10.1051/mateconf/20164605001.