

Magnetic Coupling of Two Coils Due to Flow of Pure Water Inside Them – Double Coil Volumetric Flow Sensor

Asem Mohammad AL Jarrah¹, Nader Aljabarin^{1*}

¹ Department of Natural Resources and Chemical Engineering, Faculty of Engineering, Tafila Technical University, P.O. Box 179, Tafila 66110, Jordan

* Corresponding author's e-mail: aljabarin@ttu.edu.jo

ABSTRACT

In this work a simple new type of flow sensors was developed, the double coil flow sensor. In this sensor two coils are magnetically coupled due to the flow of pure water inside them. The first coil, the primary coil, was supplied by AC voltage in the frequency range 0.5–1 MHz which is the coupling range of frequency for water. The voltage in the second coil, was found to be directly proportional with the volumetric flow rate of the water flowing inside the coils. The two coils can only be coupled in the laminar flow region. In the turbulent region, due to the turbulent chaos and fluctuation the two coils cannot be effectively coupled, and therefore the sensor cannot be used. The temperature of the water was found to have a negligible effect on the coupling, which add a good advantage to the simplicity of the double coil sensor. The working fluid used in this work was pure water. Other fluids are believed to be working as well, most probably at different frequency range, and this will be the subject of future work.

Keywords: double coil, laminar flow sensor, water magnetic coupling.

INTRODUCTION

Flow is one of the most commonly measured variable in processes and numerous types of flow sensors are available in the industry [1–3]. Despite the diversity of flow sensors, these sensors can be put into two categories. The first category is the sensors that make a resistance to the flow, and therefore, create a pressure loss in the piping line (e.g., orifice, venture, turbine, etc.). The pressure loss created by these sensors is the main disadvantage of this category. The second category, on the other hand, has no or negligible resistance to flow which is one of the main advantages of this category. Four types of flow sensors of the second category are currently exist [4–6]: ultrasound, magnetic, coriolis, and optical flow sensors. The main disadvantages or limitations of the second category are mentioned briefly as follows.

First, the ultrasound sensor, this type of sensors may need to be coupled with temperature

sensor [2] to account for the variation of temperature which is highly affect the speed of sound in fluids. The need of temperature sensor increases the complexity of the sensor because calibration at each temperature is needed. Also, a proper design is needed to eliminate the interaction of the ultrasound signal with the external noises/sounds generated by the fluid itself, piping system, and/or the surroundings. Second, the Magnetic sensor, the current type of this sensor is only working on fluids that conduct electricity [2] and this type of sensors are not working on electrically non-conductive fluids. Third, the Coriolis sensors, this type of sensors is not recommended for fluids with low pressure or low flow rate [2, 3]. Finally, the optical flow sensor, the current type of this sensors is used for slurry liquids [6] and this type of sensors is still not widely spread so far.

Based on the above, it is clear that a simple flow sensor with zero resistance to flow, working for electrically non-conductive, and non-slurry fluids, and working for low flow rate

and/or low pressure is missing in the industry. The development of this type of sensor is the objective of this work.

The goal of this research is to develop a simple and accurate sensor to measure the volumetric flow rate.

THE DOUBLE COIL VOLUMETRIC FLOW SENSOR

Sensor description

The double coil flow sensor is simply a two coils wound on a pipe as shown in Figure 1. The material of the pipe should be made of non-magnetic material. The input voltage should be AC voltage (or current) with a frequency in a specific range depends on the type of fluid. For water this range is 0.5–1 MHz as will be discussed later. The distance between the two coils, D , should be within a specific range. This distance is best determined experimentally as will be explained below.

Principle of operation

Several studies showed that, the AC magnetic field at moderate to high frequency affect Water properties [7–10]. Among these properties, which is the one we are interesting in this work, is the magnetic susceptibility, or alternatively the magnetic permeability. In a study done by Gutierrez-Mejia and Ruiz-Suarez [11], the susceptibility of pure water was measured

in a frequency range of 0.5–1 MHz, and it was found that, water change its magnetic property from diamagnetic to paramagnetic at a frequency of about 0.5 MHz. Moreover, the susceptibility continually increased with frequency up to 1 MHz, which is the upper limit of frequency covered by the study.

Therefore, in the double coil sensor, when water enters the first coil (the primary coil) it changes its properties due to the imposed AC magnetic field, and therefore, water picks up some magnetization in the first coil and becomes magnetized, so when it enters the second coil it induced a voltage (or current) in the second coil.

As the volumetric flow rate increased, the velocity of the water increased, and therefore, the rate of change of magnetic field in the second coil increased. Now, in according to Faraday’s law, the voltage in the second coil must increase, and therefore, the induced voltage in the second coil is linearly proportional to the volumetric flow rate in the pipe. The polarity of the second coil can be determined based on Lenz’s law.

In summary, the double coil volumetric flow sensor is similar to a transformer in its behavior. The coupling material is water at moderate frequency and the induced voltage in the second coil is directly proportional with the volumetric flow rate inside the coils.

Restrictions

Two restrictions must be considered here for the sensor to work. First, the material of the

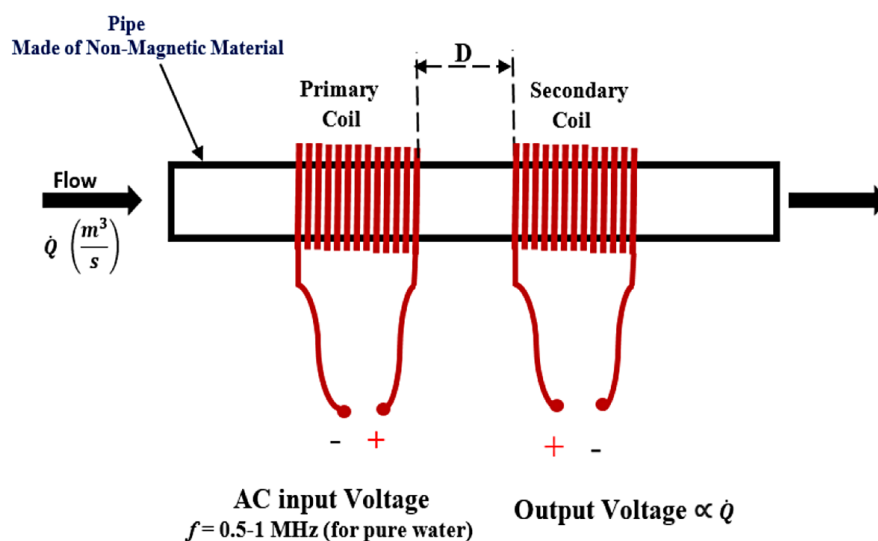

Fig. 1. Schematic description of the double coil flow sensor

pipe should be non-magnetic material to prevent magnetic coupling through the pipe itself. Second, the distance between the two coils, D , needs to be within a specific range. Short distance will result in coupling the two coils through air and long distance will result in losing the water its magnetization which already gains in the first coil, so no induced voltage will result in the second coil. The range of distance between the coils, D , can be determined experimentally as follows:

1. Before starting the flow, one of the coils is sliding toward the other so that the two coils are in touch.
2. The primary coil is supplied by the input voltage and frequency as required.
3. The distance between the two coils is gradually increased until the output signal from the secondary coil becomes zero. This insures that coupling through air is eliminated. This distance is the lower end of the distance range.
4. The flow is turned on. An output signal in the secondary coil should appear.
5. The distance between the coils now is again gradually increased until the output signal in the second coil disappears. At this distance water loose its magnetization so no induced voltage in the secondary coil occurs, and therefore, this is the upper range of the distance between the coils.

Experimental testing of the sensor

The developed sensor was tested using the equipment shown in Figure 2. A distilled and de-ionized water was used in the testing. A functional signal generator was used to generate an input sine wave with the required frequency in the primary coil and an oscilloscope was used to analyze the output signal from the secondary coil. A rotameter was used to measure the volumetric flow rate which is controlled using hand valve. The temperature of the water was increased as required using a coiled heater. A stirrer was used to make the temperature inside the tank homogeneous and a thermometer was used to measure the temperature.

A photo of the developed sensor in shown in Figure 3. The pipe of the sensor is made of vinyl. The inside diameter of the pipe is 8 mm, and the outside diameter is 11 mm. A commercial copper wire of 1 mm diameter was used to wind the coils by hand.

The number of turns in the primary coil is 46 and in the secondary coil is 48. A Sine wave of amplitude of 5 V is used in the primary coil. The number of turns and the amplitude of the input voltage are experimentally selected such that the output voltage from the secondary coil is within the range of measurement of the used oscilloscope. Finally, before starting the measurements, the distance between he coils was determined as explained in restrictions and an adhesive tape was used to fix the coils in place.

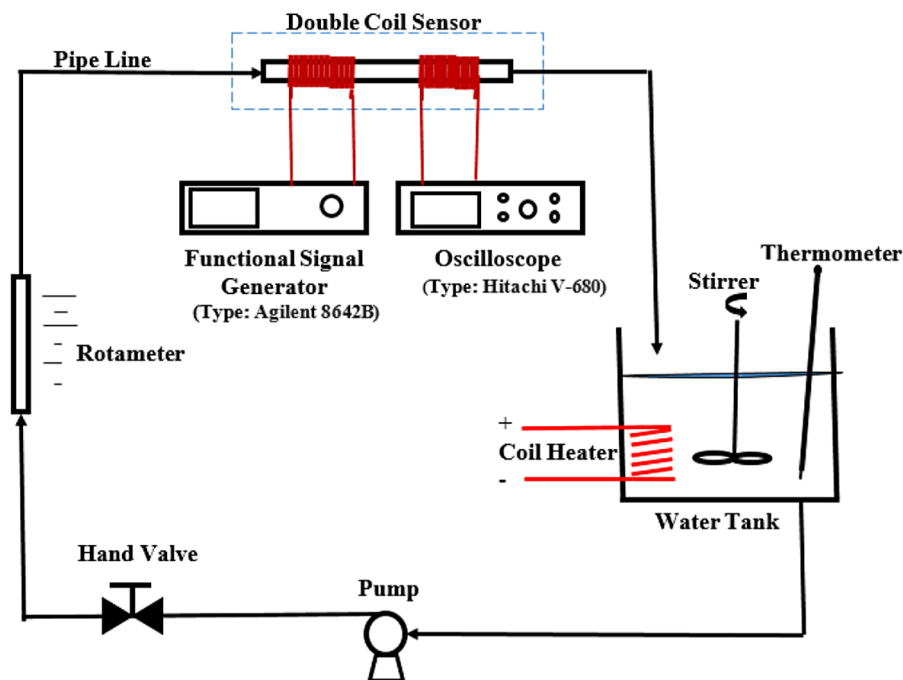

Fig. 2. Sensor testing experimental setup



Fig. 3. A photo of the developed sensor, $n_2/n_1 = 48/46$

RESULTS AND DISCUSSION

Figure 4 shows V_o/V_i as a function of flow rate at 0.5 MHz and room temperature. It can be seen that three regions can be clearly recognized; laminar, transition, and turbulent. In the laminar zone the output voltage is increasing linearly with the flow rate. In the transition zone, the output voltage is still increasing but in a nonlinear way. In the turbulent zone the output voltage is rapidly decreasing with the flow rate until the output signal completely disappear. Also, it can be seen that a scattered data was obtained in the turbulent zone.

The results of Figure 4 can be explained as follows: when the water enters the first coil, the water particles get magnetized, and it is now behaving as tiny dipoles. Due to the magnetic field

of the first coil, these tiny dipoles are arranged in a way such that its axis is parallel to the direction of the magnetic field which is along the axis of the pipe. In the laminar flow, the arrangement of these tiny dipoles remains undisturbed by the flow, so that when they enter the second coil, their effect add together. In the turbulent flow, the chaos created by the turbulence disturb the uniformity of these tiny dipoles; and therefore, makes their direction random which in turn makes the effect of some is cancelled by other, so a reduction in the amount of coupling is result. The more the turbulent is, the more the chaos is; and therefore; the less coupling will result until a point where the randomness of the tiny dipoles almost completely canceled by each other so no output voltage will result. Moreover, the fluctuation (or

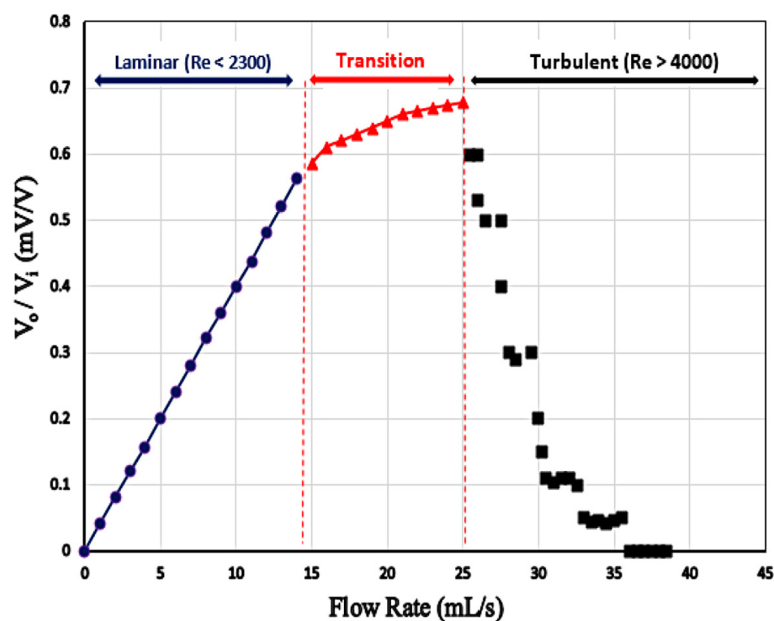

Fig. 4. Output voltage vs. flow rate at 0.5 MHz, 21.5°C

the instability) in the turbulent flow makes the output voltage fluctuate, which is the cause of the obtained scattered values in the turbulent zone. In the transition zone, where chaos is still not rigorous, an intermediate behavior is obtained.

Also, it can be seen that from Figure 4; in the laminar zone; the two coils can be effectively coupled, and the output voltage is linearly proportional with the flow rate. In the turbulent zone, coupling the two coils is not effective.

Figure 5 shows V_o/V_i as a function of flow rate at different frequencies in the laminar zone. The figure also shows the coefficient of determination

(R^2) for each frequency. Two observations can be seen in this figure. First, as the frequency increased the output voltage increased but R^2 decreased. This suggest that turbulence can be enhanced by increasing frequency. Second, as the frequency decreased the range of laminar zone decreased, but R^2 increased which suggest that magnetization at low frequency is weak so at high flow rate the water has no sufficient time to get completely magnetized in the first coil.

It can be seen from Figure 5 that the best range of frequency to run the sensor is 0.5–1 MHz which cover a wider range of laminar flow

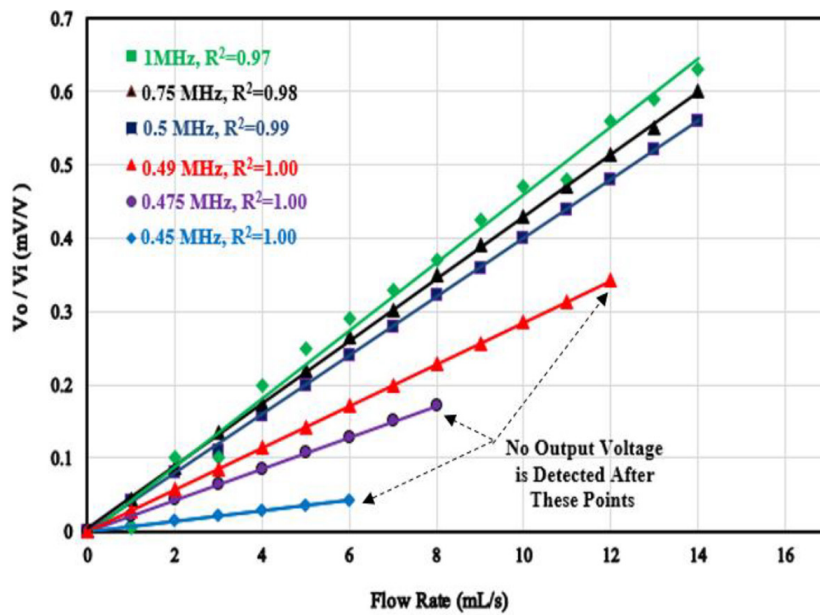

Fig. 5. Output voltage vs. flow rate at different frequencies in the laminar zone, 21.5°C

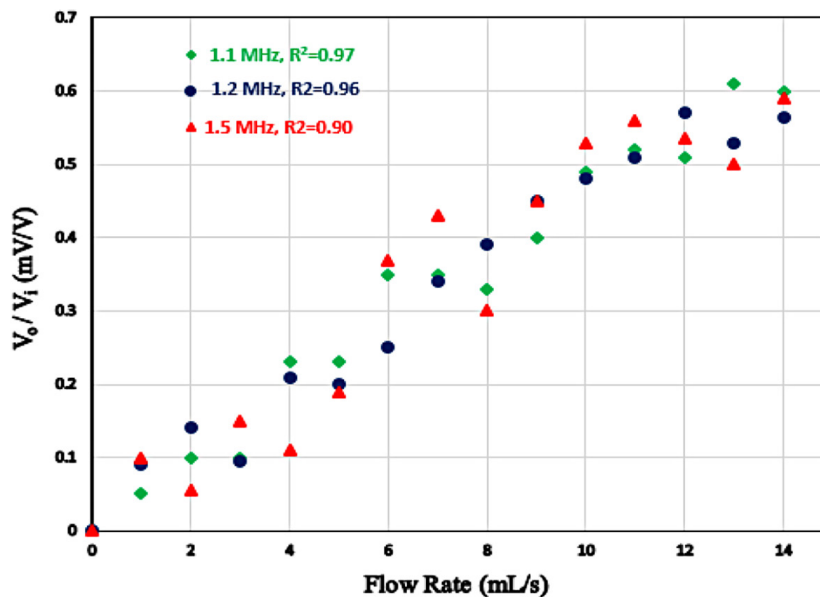

Fig. 6. Output voltage vs. flow rate at higher frequencies in the laminar zone, 21.5°C

with excellent accuracy. To avoid enhancing turbulence by frequency, the most recommended value is 0.5 MHz.

To study the effect of frequency higher than 1 MHz on the output voltage, figure 6 was produced. This figure shows that, for frequency higher than 1 MHz, a scattered data was obtained, and the amount of scattering increased as the frequency increased. This figure again suggests that turbulence is enhanced at higher frequency.

The reason why turbulence is enhanced at high frequency can be explained as follows: at higher frequency water particles gain more magnetization. Now, if these particles (tiny dipoles) encounter any disturbance, this disturbance is amplified due to the repulsion and attraction

between these tiny dipoles, and therefore, turbulence is increased.

Figure 7 shows the output voltage vs. the number of turns ratio. It can be seen that as the ratio increased the output voltage increased until the ratio becomes 1. Further increase in the ratio has no significant increase on the output voltage. Therefore, a ratio of 1 is a quick design rule for the sensor.

Finally, Figure 8 shows the effect of temperature on the output voltage. It can be seen that; the temperature almost has no effect on the output voltage. Therefore, the double coil flow sensor needs to be calibrated only at one temperature and not over a range of flow temperature as some sensors may need.

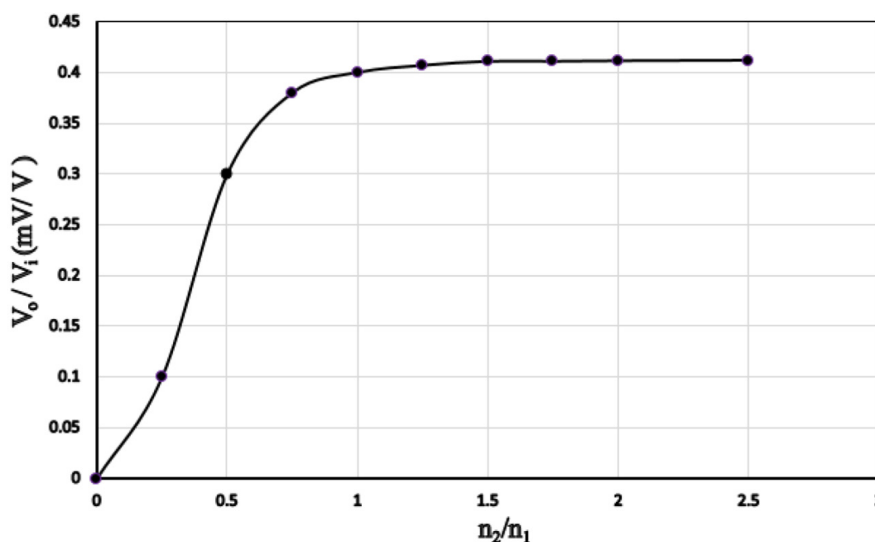

Fig. 7. Output voltage vs. number of turns ratio

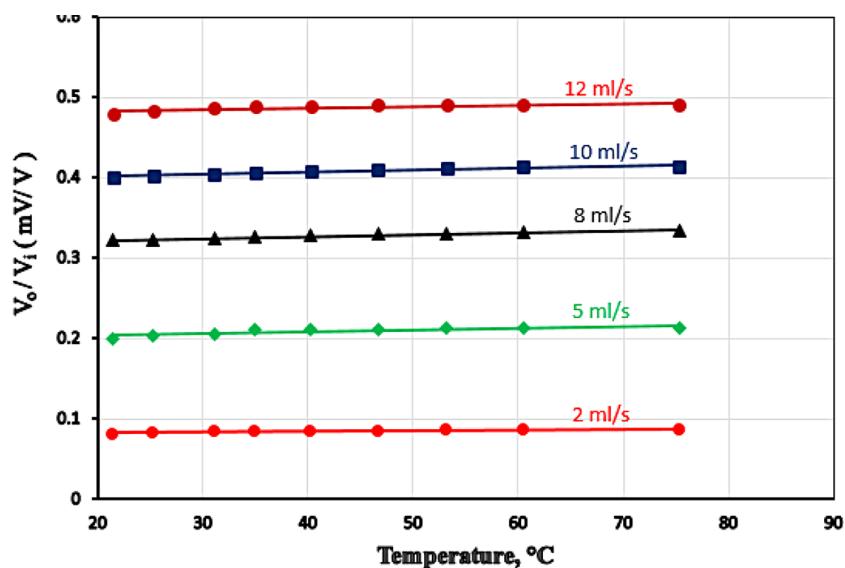

Fig. 8. Output voltage vs. temperature at different flow rates

CONCLUSION

In this work several points can be concluded. Two coils can be effectively coupled due to flowing of water inside them at a frequency of 0.5–1 MHz. The secondary voltage is linearly proportional to the volumetric flow rate in the laminar flow zone. The coupling frequency for water is 0.5–1 MHz. Above 1 MHz coupling is still possible, but a scattered data will result. For frequencies from 0.45–0.5 MHz, linear coupling is existing, but a shorter range of flow rate is covered. For frequencies below about 0.45 MHz, no coupling is existing. Increasing frequency will result in enhancing mixing or increasing turbulence. This is due to the attraction and repulsion forces between the particles of the water due to its magnetization when exposed to AC voltage at medium frequency. An equal number of turns is sufficient to couple the two coils. Adding more turns will not significantly improve the coupling. The temperature is almost having no effect on the coupling of the coils.

REFERENCES

1. Miller R.W. Flow Measurement Engineering Handbook; 1996.
2. Endress and Hauser Company Documentations. Flow Measuring Technology for Liquids, Gases and Steam, <https://www.endress.com/en/downloads>. 3/2018.
3. La Nasa P.J., Upp E.L. Fluid Flow Measurement: A Practical Guide to Accurate Flow Measurement; 2014.
4. Liptak B.G. Instrument Engineers' Handbook, Volume. 1: Process Measurement and Analysis; 2003.
5. Smith C.A., Corripio A.B. Principles and Practice of Automatic Process Control, 3rd Ed., 2015.
6. Platt C. Encyclopedia of Electronic Components; 2016; 3.
7. Wang Y., Wei H., Li Z. Effect of magnetic field on the physical properties of water. *Results in Physics*. 2018; 8: 262–267.
8. Rusiniak L. Electric Properties of Water. New Experimental Data in the 5Hz-13Mhz Frequency Range. *Acta Geophysica Polonica*. 2004; 52(1): 63–76.
9. Kitazawa K., Ikezoe Y., Uetake H., Hirota N. Magnetic field effects on water, air and powders. *Physica B: Condensed Matter*. 2001; 294–295: 709–714.
10. Cai R., Yang H., He J., Zhu W. The effects of magnetic fields on water molecular hydrogen bonds, *Journal of Molecular Structure*. 2009; 938(1–3): 15–19.
11. Gutierrez-Mejia F., Ruiz-Suarez J.C. AC magnetic susceptibility at medium frequencies suggests a paramagnetic behavior of pure water. *Journal of Magnetism and Magnetic Materials*. 2012; 324: 1129–1132.