

**Scientific Papers of
the Institute of Electrical Power Engineering of
the Wrocław University of Technology**

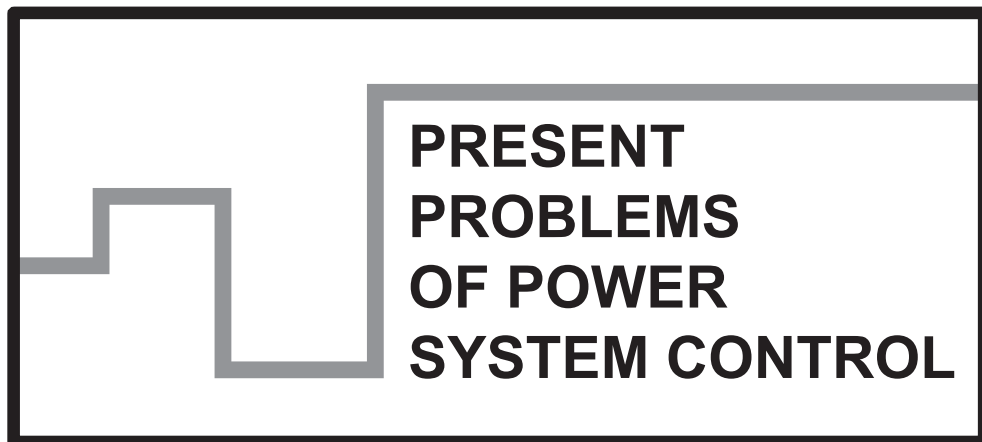

Wrocław 2013

Guest Reviewers

Ivan DUDURYCH
Tahir LAZIMOV
Murari M. SAHA

Editorial Board

Piotr PIERZ – art manager
Miroslaw ŁUKOWICZ, Jan IŻYKOWSKI, Eugeniusz ROSOŁOWSKI,
Janusz SZAFRAN, Waldemar REBIZANT, Daniel BEJMERT

Cover design

Piotr PIERZ

Printed in the camera ready form

Institute of Electrical Power Engineering
Wrocław University of Technology
Wybrzeże Wyspiańskiego 27, 50-370 Wrocław, Poland
phone: +48 71 320 26 55, fax: +48 71 320 26 56
www: <http://www.ie.pwr.wroc.pl/>; e-mail: Inst.Energ@pwr.wroc.pl

All right reserved. No part of this book may be reproduced by any means, electronic, photocopying or otherwise, without the prior permission in writing of the Publisher.

© Copyright by Oficyna Wydawnicza Politechniki Wrocławskiej, Wrocław 2013

OFICyna WYDAWNICZA POLITECHNIKI WROCLAWSKIEJ
Wybrzeże Wyspiańskiego 27, 50-370 Wrocław
<http://www.oficyna.pwr.wroc.pl>
e-mail: oficwyd@pwr.wroc.pl
zamawianie.ksiazek@pwr.wroc.pl

ISSN 2084-2201

Drukarnia Oficyny Wydawniczej Politechniki Wrocławskiej. Order No. 706/2013.

Tahir LAZIMOV*, Esam SAAFAN**

TRANSITIONAL PROCESSES AT SWITCHING-OFF UNLOADED POWER TRANSMISSION LINES BY MODERN CIRCUIT-BREAKERS AND THEIR COMPUTER SIMULATION

The article presents results of transitional processes' computer simulation at switching-off unloaded power transmission line of rated voltage 220 kV by auto-compression (SF6) circuit-breakers. Transitional voltages (voltage across the line terminals and recovery voltage) at switching-off were calculated and studied in the research carried out. There was also considered dependence between transitional voltages' magnitudes and power transmission lines lengths. There were studied some computational peculiarities of the problem under consideration. In particular, the numbers of pi-sections provided satisfactory adequacy of lines' equivalency at computer simulation for their typical lengths were determined. There were also estimated optimum simulation parameters provided stability of transitional regime parameters.

1. INTRODUCTION

Switching-off power transmission lines is well-studied transitional process for power electric systems [1, 2].

There is a common peculiarity for all the kinds of transitional processes at their computer simulation conditioned by possible losing of transitional regime parameters' (voltages and currents in the present research) stability. It takes place because of so called "stiffness" of differential equations' solutions and rounding errors accumulation [3,4]. It is especially important matter for computer simulation of transitional processes having high steepness e.g. switching-off electric current in mediums with great electric strength such as vacuum or highly-pressed SF6. Arc quenching in such

* Electric Supply and Insulation Chair, Azerbaijan Technical University, AZ1009, Baku, Azerbaijan, tahir lazim@gmail.com

** Faculty of Engineering, University of El-Mansoura, Box 35516, Mansoura, Egypt, esam_ali_saafan@yahoo.com

mediums is accompanied with steep splashes of recovery voltages. From the computational point of view it means increasing of instantaneous values of voltages and corresponding growth of rounding's local errors.

Computer simulation of transitional processes in power transmission lines brings another one characteristic in research. It is necessary to determine number of pi-sections modeling transmission line provided satisfactory tolerance at scheme transformation [5]. This number may depend on some factors such as power transmission line's rated voltage, length and also some geometrical dimensions and sizes of towers and phase conductors. In other words, it directly depends on free frequency of transitional process, line length and electromagnetic waves' propagation speed along the line [6].

2. COMPUTATIONAL GROUND

An electrical connection scheme and corresponding equivalent network of unloaded 220 kV power transmission line are presented in the Fig. 1.

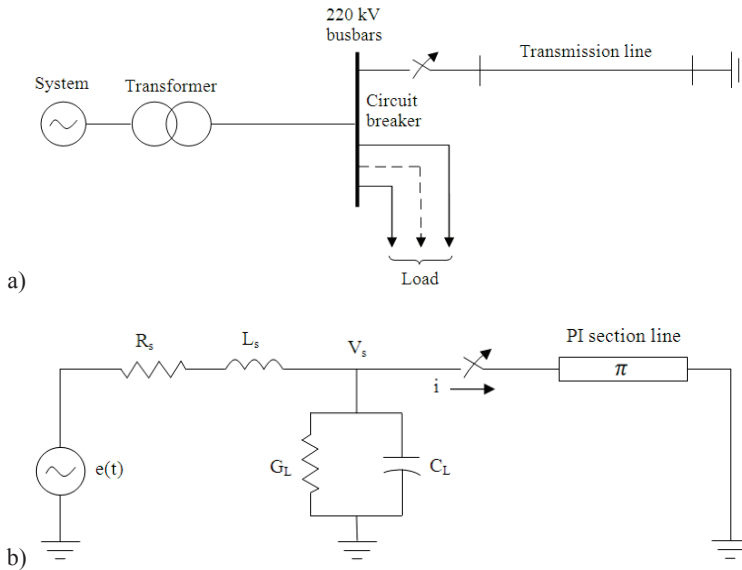

Fig. 1. Switching-off power transmission line:
a) electrical connection scheme; b) equivalent network

The following denotations are used in the Fig.1:

- $e(t)$ is system's e.m.f.;
- R_s and L_s are correspondingly resistance and inductance of the equivalent system the line considered connects to;

- G_L and C_L are correspondingly conductivity and capacitance of the substation 220 kV busbars' load;
- V_s is voltage of the line on the system side;
- pi-sectioned line is the equivalent network for the 220 kV's transmission line of given length.

The following per unit parameters of 220 kV's power transmission line were used [7]:

- resistance $R_o = 0.08$ Ohm/km;
- inductance $L_o = 1.31$ mH/km;
- capacitance $C_o = 8.79$ nF/km.

The switching-off processes were researched at case of use auto-compression (SF6) circuit-breaker. It was modeled by its chopping current determined depending on magnitude of switched-off current in accordance with [8] and electrical strength restoration law which in accordance with [9,10] is the cosine one.

For computer simulation of 220 kV's power transmission line's switching-offs we used the MATLAB ordinary differential equation (ode) solvers especially ode 23tb method and some others (ode 23t and ode 15s) [5,11].

The optimum parameters of computer simulation were determined by the condition to obtain stable solutions of the differential equations formalized transitional voltages and currents as it was done e.g. in [11, 12, 13]. It is widely known that possible loosening of stability is conditioned by "stiffness" of the differential equations related transitional voltages and currents with their first temporal derivatives [3, 14]. "Stiff" differential equations are sensitive to unavoidable accumulation of rounding errors may cause loosening of stability.

Further stability of the problem under consideration will be estimated.

3. RESULTS OBTAINED AND DISCUSSION

In the Fig.2, Fig.3 and Fig.4 the curves of transitional voltages (on the 220 kV busbars, on the line's input and recovery one) at use computer simulation for the number of pi-sections $N = 1$ and lines length's 80, 120 and 160 km are presented.

In accordance with [2] aerial power transmission lines of lengths less than 150–250 km can be presented by only pi-section i.e. line parameters' distribution may not be taken into account. It means neglecting of wave character of transitional processes for minded lengths and use of lumped parameter's model. In general expediency of taking into account distributed parameters must be estimated by comparison of length corresponded to the greatest natural frequency with the length of considered line.

As it is seen from the Fig. 2, Fig. 3 and Fig. 4 the natural frequencies for the lines of lengths 80, 120 and 160 km are correspondingly equaled 1175, 850 and 620 Hz.

The wave lengths are equaled about 254, 353 and 483 km in the same correspondence (determined as a ratio of electromagnetic waves propagation speed and natural frequency).

On the other hand there is another way to estimate the number of pi-sections needed for the line equivalent representation given in [6]. As it is shown in [6] the number of pi-sections used relates with the maximum frequency by the following expression,

$$f_{\max} = \frac{N\mathcal{G}}{8l'} \quad (1)$$

where $\mathcal{G} = (L_o C_o)^{-0.5}$ is electromagnetic waves' propagation speed along the line; l' is length of line.

The minded velocity for the line under consideration is equaled to 294693 km/s. Then the maximum number of pi-sections for the lines of lengths 80, 120 and 160 km will be equaled to 2.55, 2.77 and 2.69 correspondingly. It means that in accordance with [6] the number considered may be taken as 1 or 2.

Note that simulation results presented in the Figs. 2, 3 and 4 were obtained at use the ode 23tb method for initial step size 100 nanoseconds and tolerance 10^{-7} .

Let us now consider simulation at use the number of pi-sections more than 1. Research carried out had shown that results of computer simulation at different numbers of pi-sections may distinguish seriously enough. E.g. difference between magnitudes of transitional voltages across the line terminals at $N = 1, 2$ and 3 may reach 48%, difference between transitional recovery voltages – 20%. Moreover, there is not any regularity between calculated transitional voltages and the number of pi-sections used.

In the Fig. 5 and Fig. 6 are presenting curves of transitional voltages obtained at computer simulation switching-off 220 kV's power transmission line of length 120 km by SF6 circuit-breaker for number of pi-sections 2 and 3. Comparing these curves with ones presented in the Fig. 3 (i.e., for the same line at $N = 1$) we can see that the high-frequency oscillations appearing in the cases of use different numbers of pi-sections is distinguished enough. It has no any physical meaning because just only natural frequency may characterize real line with no connections between circuit-breakers installed on its edges. Obviously the oscillations seen in the Fig. 5 and Fig. 6 (unlike ones in the Fig. 3) have calculative nature and causes by dividing line's length at pi-sectioning.

The power transmission lines of rated voltages higher than considered one may have greater lengths and correspondingly less natural frequency. Our research has shown that for the longer lines pi-sectioning at more than 1 section may be more expedient. Remind that historically lines' pi-sectioning was worked up for steady-state regimes. Increasing line's length is a kind of approaching the line's natural frequency to the standard one.

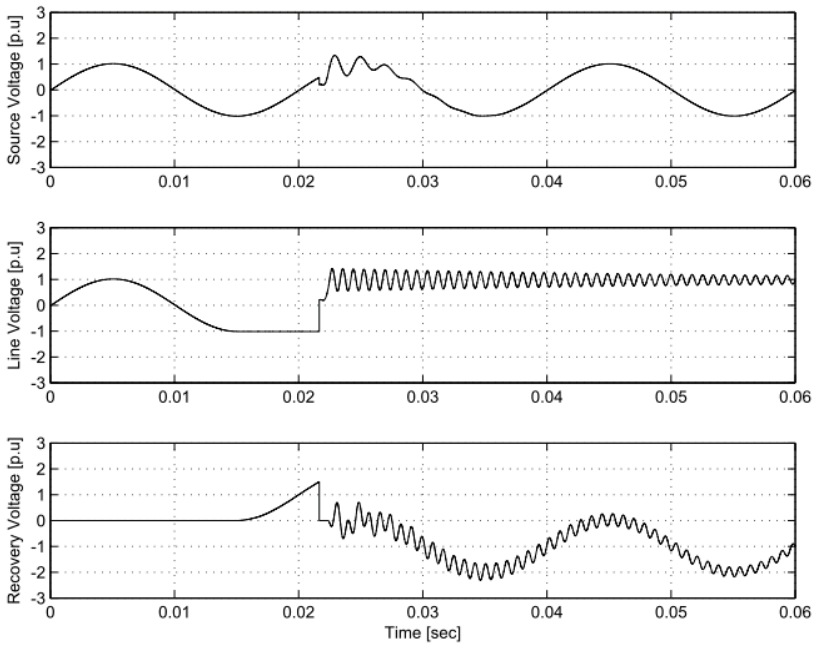

Fig. 2. Transitional voltages at line length 80 km, $N = 1$

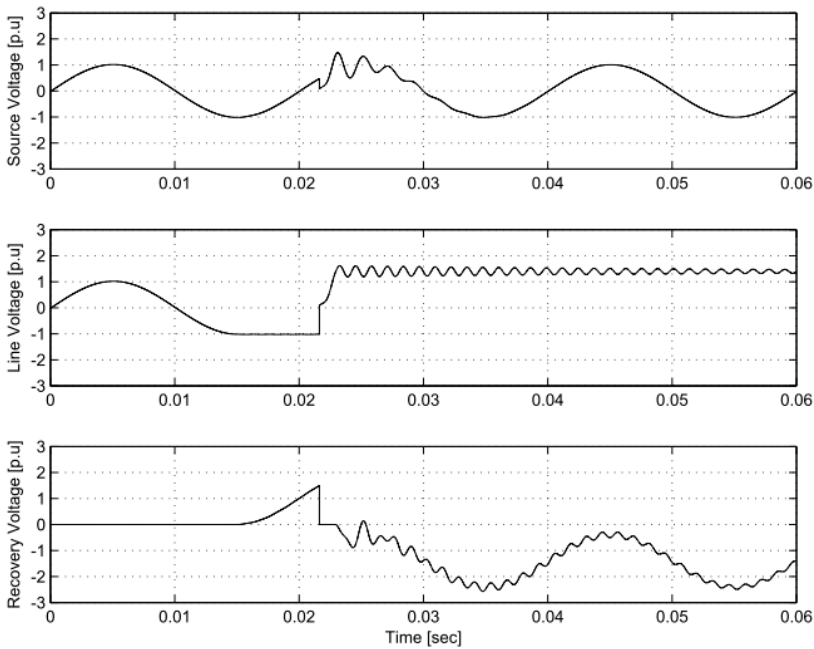

Fig. 3. Transitional voltages at line length 120 km, $N = 1$

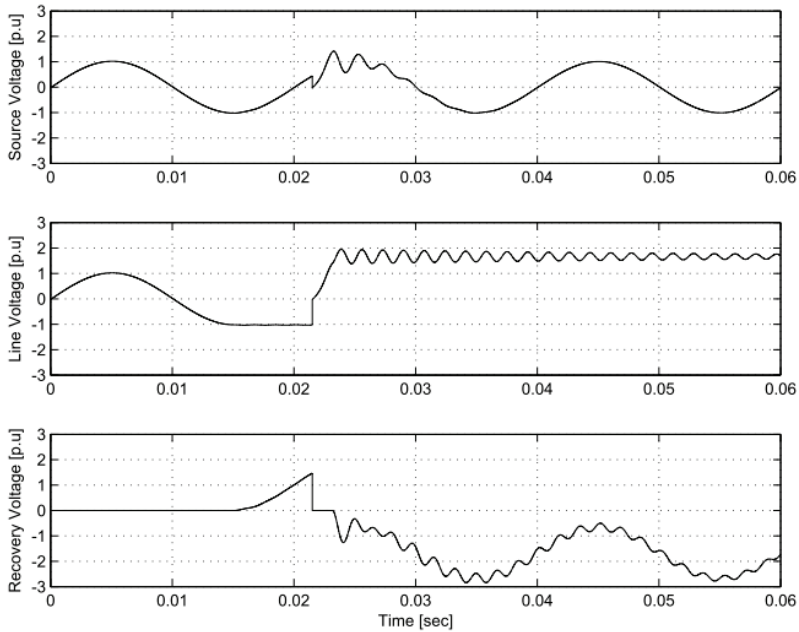

Fig. 4. Transitional voltages at line length 160 km, $N = 1$

Analyzing Fig. 2, Fig. 3 and Fig. 4 from the point of view transitional voltages' magnitudes we can state that switching-off unloaded 220 kV power transmission lines by SF6 circuit-breakers does not cause appearance of voltages on lines' terminals more than allowable one. In the same time recovery voltages across the circuit-breakers' poles may prevail above allowable grade for relatively long lines.

4. ON STABILITY

In the present research the ode 23tb method was mainly used. While carrying out the research we had stated that it was possible to get stable solutions for all the transitional voltages just at initial step sizes no more than 100 nanoseconds in wide range of tolerances minded above. Note that at computer simulation the problems of switching-off capacitor banks and unloaded power transmission lines [11, 15] we got sometimes stable solutions at greater initial step sizes. It means that the problem of computer simulation the switching-offs unloaded power transmission lines is sensitive enough to changes of initial step size.

We have also noticed that increasing the number of pi-sections leads to worsening of stability. It takes place because of additional contribution in global error brought by artificial calculations conditioned by power transmission line pi-sectioning at $N > 1$.

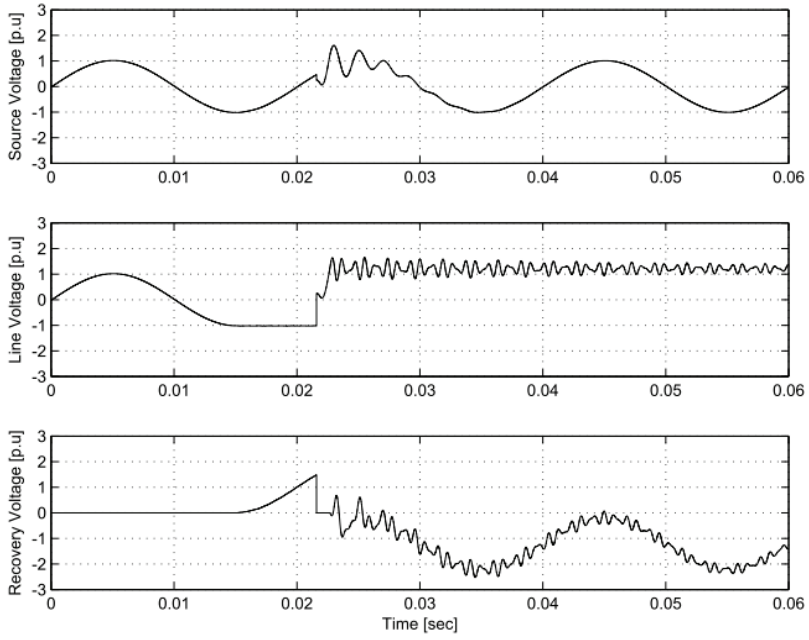

Fig. 5. Transitional voltages at line length 120 km, $N = 2$

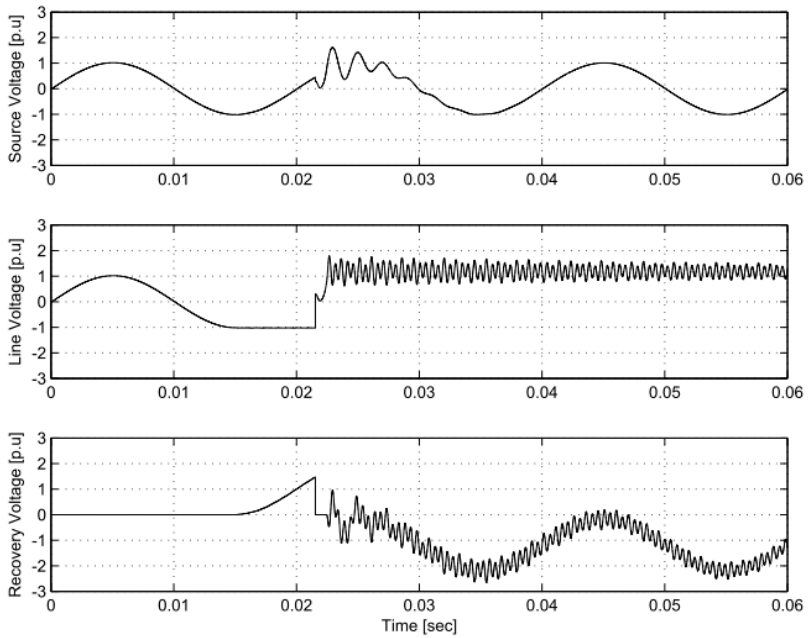

Fig. 6. Transitional voltages at line length 120 km, $N = 3$

5. CONCLUSIONS

Transitional voltages across the terminals at switching-off unloaded 220 kV power transmission lines by SF6 circuit-breakers do not exceed the allowable value of this insulation grade. Transitional recovery voltages at the same switching may exceed the minded grade for longer lines.

As a rule transitional voltages have greater values for longer lines. It may be explained by approaching the current chop instant to the current zero for longer lines. As a result current interruption takes place at greater angle between switched-off current and voltage phasors (closer to 90 degrees). It means appearance of a greater magnitude of voltage across the line terminals at the current chop instant.

Relatively little (in comparison with wave length corresponded to natural frequency) length of 220 kV power transmission lines lets to present their equivalent network with just only pi-section at computer simulation switching-off transient. Use of greater number of pi-sections is not expedient because that it causes artificial oscillations of transitional voltages conditioned by the dividing of line by shorter sections had free frequencies more than line's natural frequency. These artificial oscillations distort curves and magnitudes if transitional voltages.

REFERENCES

- [1] BICKFORD J.P., MULLINEUX N., REED S.R., *Computation of Power System Transients*, Peter Peregrinus, Ltd., England, 1976.
- [2] RAZEVIK D.V., *High Voltage Engineering*, Khanna Publishers, Delhi 1972.
- [3] SHAMPINE L.F., *Numerical Solutions of Ordinary Differential Equations*, Chapman and Hall, New York 1994.
- [4] HAIRER E., NORSETT S.P., WANNER G., *Solving Ordinary Differential Equations. Part 1*, Springer-Verlag, Berlin, Heidelberg, New York, London, Paris, Tokyo 1987.
- [5] LAZIMOV T.M., IMANOV S.V., *Some results of unloaded line switching-offs' computer simulation*. Proceedings of the ELECO '2007 International Conference, Bursa, Turkey, 2007, 147–150.
- [6] <http://www.mathworks.com/help/physmod/powersys/ref/pisectionline>
- [7] BAUMSTEIN I.A., BAJANOV S.A., *High Voltage Electrical Installations*, Energoatomizdat, Moscow, 1989 (in Russian).
- [8] RUBEN D. GARZON, *High voltage circuit breakers design and applications*, Marcel Dekker, New York 2002.
- [9] LAZIMOV T.M., AKHUNDOV S.A., *Modeling of electrical strength of high voltage circuit-breakers*. Proceedings of the International Symposium SIEMA '2001, Kharkov, Ukraine, October 18–20, 2001, 112–114 (in Russian).
- [10] AKHUNDOV S.A., Abstracts of Ph.D. Thesis, Baku 2002.
- [11] LAZIMOV T.M., SAAFAN E.A., *On interaction between circuit-breaker and network at small inductive currents switching-offs*, Present Problems of Power System Control, No. 1, Wrocław, Poland, 2011.

- [12] LAZIMOV T.M., IMANOV S.V., *On stability while simulating the switching-offs the capacitive and small inductive currents*. Proceeding of the MEPS '06 International Symposium, Wrocław, Poland, Sep. 2006, 407–410.
- [13] SAAFAN E.A., Abstracts of Ph.D. Thesis, Baku 2012.
- [14] LAZIMOV T., AKHUNDOV S., *Peculiarities of transients' simulation in electrical circuits*. Proceedings of the Republican Conference on IT, Baku, Azerbaijan, 2003 (in Russian).
- [15] LAZIMOV T., IMANOV S., SAAFAN E.A., *Transitional Recovery Voltages at Capacitive Currents Switching-off's by Vacuum and SF6 Circuit-Breakers*, Energy and Power Engineering, Vol. 6, No. 5, Chicago, USA, 2012.