



Optical Initiation of Polymer Containing Formulations of Azole Metal Complexes

Sergei I. GERASIMOV^{1, 2, 3, *}, Mikhail A. ILYUSHIN⁴,
Vadim A. KUZ'MIN^{2, 3}, Irina V. SHUGALEI⁴

¹ *Sarov' Physics-Technical Institute RNU MIPhI,
607186, Sarov, Russia*

² *Russian Federal Nuclear Centre – All-Russian Research
Institute of Experimental Physics, 607186, Sarov, Russia*

³ *Nizhnyi Novgorod State Technical University,
named after R. E. Alekseev, Russia*

⁴ *Saint-Petersburg State Institute of Technology
(Technical University) 190013, Russia*

**E-mail: s.i.gerasimov@mail.ru*

Abstract: This article focuses on an investigation of the optical initiation of the light-sensitive energetic complex perchlorates 3(5)-hydrazino-4-amino-1,2,4-triazole copper(II) perchlorate and 1-H-5-hydrazinotetrazole mercury(II) perchlorate. It is shown that light emission initiates an explosion in energy-rich formulations (compositions) based on these complexes, EC-1 and EC-2 respectively. It was found that the pyrotechnic formulation EC-2 containing the mercury complex may be used to initiate detonation in highly energetic materials.

Keywords: optical initiation, energetic formulations EC-1 and EC-2

1 Introduction

Reliability and high speed of operation has made the electrical method of detonation initiation the major method used in the twentieth century. The disadvantage of this method of initiation is the sensitivity of electric detonators to static electricity, stray electric currents and electromagnetic fields. Light initiation of explosive material

charges is a promising method for blasting work because of its high safety. The initiation of energetic material charges with a light pulse provides reliable protection of the circuit from false pulses, as there are no random sources with sufficient power in the optical range to initiate blasting caps [1-5]. Light initiation may be successfully used in many explosion technologies and gas-dynamic devices. At present in the USA, pulse laser initiation of light-sensitive energetic materials is the most popular technique that makes it possible to create reliable initiation devices for rocket and space technology [5] and artillery systems [6]. Laser initiation techniques need highly qualified professionals to be able to carry out adjustment of the optical path of the laser initiation devices. Laser diodes and non-coherent light sources, being simpler and more reliable, may be more promising for excitation of optical detonators under intense mechanical and thermal loading, with lack of diagnostic equipment, and poor training of explosive operators.

Chemical processes occurring during irradiation of chemically active materials with sources of light radiation have their special characteristics. Primarily these characteristics are associated with non-equilibrium states caused by time-dependent reactions, and secondly, with the mutual influence of the chemical state of the environment, and processes of energy and mass transfer in the field of a powerful light wave. Unfortunately these problems remain unsolved.

In the present paper, the experimental results of the interaction of the energetic formulation EC-2 with a laser diode beam and the interaction of formulations EC-1 and EC-2 with a pulse of non-coherent radiation from a flash lamp, are discussed.

2 Experimental

3(5)-Hydrazino-4-amino-1,2,4-triazole copper(II) perchlorate was synthesized according to a literature method [7]. The method for the preparation of 1-H-5-hydrazinotetrazole mercury(II) perchlorate is given in [8]. In the preparation of the energetic formulations EC-1 (copper perchlorate complex) and EC-2 (mercury perchlorate complex), an optically transparent polymer [a copolymer of 2-methyl-5-vinyltetrazole (~98%) and methacrylic acid (~2%) (PVMT) (Technical requirements TU 38-403-208-88)] was used as an inert matrix (binder) in an amount of 10 ± 1.5 wt.% of the metal complexes. The energetic formulations EC-1 and EC-2 were prepared according to the method described in [9]. Testing of the energetic formulations was carried out in 5 mm diameter brass caps of 2 mm height. The properties of the light-sensitive copper(II) and mercury(II) chlorate(VII) complexes, as well as the light-sensitive formulations EC-1 and EC-2, are given in [10-17].

3 Discussion

3.1 Study of the interaction of the light-sensitive formulation EC-2 with a laser diode

The interaction of the light-sensitive formulations EC-1 and EC-2 with a pulsed solid state neodymium laser ($\lambda = 1.06 \mu\text{m}$) had been studied previously, both in the mono pulse mode and in the free generation regime. The ignition delay for the EC-1 formulation under the mono pulse mode ($\tau = 30 \text{ ns}$) was $5 \pm 2 \mu\text{s}$. The ignition delay for the EC-2 formulation under the mono pulse mode ($\tau = 10 \text{ ns}$) did not exceed 400 ns . In the free generation mode ($\tau = 30 \mu\text{s}$) it varied from 1 to $15 \mu\text{s}$, on decreasing the pulse energy density (J/cm^2) by a factor of 10 . For both formulations, laser radiation of sufficient energy density caused an explosion of the EC that could initiate detonation of the charge of another energetic material. The initiating ability of the energetic light-sensitive EC-2 formulation was higher than that of the EC-1 formulation. A model optical detonator (OD) was designed on the basis of formulation EC-2, where the formulation EC-2 was separated from the blasting explosive by a metal cup, to make the sample safer. Initiation of the OD was performed through an optical fibre by the light from a mono pulse neodymium laser. Initiation of EC-2 in all cases led to the transfer of detonation to a charge of HE (PETN or RDX) placed under the cup [5].

Laser diodes have found practical application as sources of energy pulses for the initiation of detonation in light-sensitive energetic materials [6, 19, 20]. However, there is no information in the literature about the possibility of initiating an explosion in charges of EC-1 and EC-2 formulations by means of laser diodes.

The processes of initiation of explosion in charges of EC-2 formulations were investigated with a TO-56 type laser diode (People's Republic of China), producing radiation of 445 nm wavelength (blue light) with a radiation output power of 1 W . The flowchart of a PRC radiator setup is shown in Figure 1.

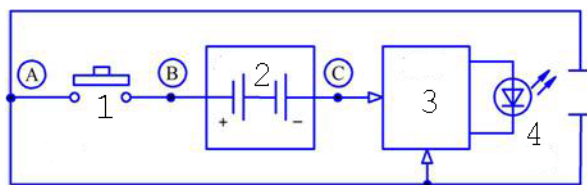

Figure 1. Flowchart of the TO-56 type laser diode setup. 1: Start press-button; 2: storage battery; 3: pulse power supply (PPS); 4: laser diode (LD); A, B, C – management scheme points of connection.

The TO-56 type laser diode has a built-in pulse power supply (PPS) working from 2 storage batteries having a voltage of 3.7 volts. The principal feature of the PPS setup is the existence of time-delay and time of acquiring the output mode. For stabilization of the parameters of the PPS a synchronizable electronic control scheme was developed. The scheme included an electronic key with a minimum possible voltage failure, and a stabilized source of sufficient power was used instead of a storage battery, for work with a laser diode. These changes prevented a decreasing radiation level at prolonged luminescence times.

The IRT4905 enhancement mode transistor, with the induced channel, was applied as an electronic key. Transistor IRT4905, having allowable power dissipation, operating voltage and speed, is perfectly suited as the electronic key. The scheme of the TO-56 type laser diode setup controlled by the electronic key is shown in Figure 2.

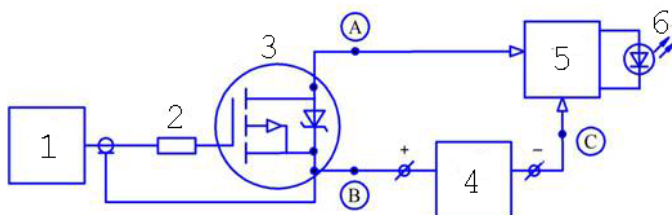

Figure 2. The control scheme of the TO-56 type laser diode setup with an electronic key.

1: AKIP-3402 type pulse generator (PG); 2: resistor; 3: IRT4905 transistor; 4: B5-90 type power supply (PS) for the laser diode; 5: pulse power supply (PPS); 6: laser diode.

Electronic key control was provided by a AKIP-3402 (Russia) type pulse generator in active output resistance mode. Duration-adjustable pulses of PG AKIP-3402 were varied in the range 0-1 s in 1 ms increments. For the laser diode, a B5-90 type power supply (Russia) was used. The radiation source was connected to the power supply through a control circuit for the pulse duration and PG. The pulse duration of the PG was in the range from 3 ms up to 3 s.

Delay time measurement of the switching PPS showed that with the above type of power of laser diode, the delay time of the PPS was equal to 2.5 ms, and the time to total radiation power was 7.3 ms. Thus, the total time-to-emitter-up period was not more than 10 ms.

In the study of the sensitivity of the EC-2 formulation to photons of blue light, a cap with EC-2 composition was mounted in a hole (diameter 5.5 mm) in a Plexiglass board. The fittings were installed at 300 mm distance from the

emitter. The explosion of the EC-2 formulation was accompanied by a loud bang and was recorded with a high-speed video and photosensors. Taking into account the amendments to the output of the radiator to the operating mode, the average time of initiation in the experiments with fifty assemblies was 30 ± 10 ms. Figure 3 shows a sequence of images for the initiation process of the EC-2 formulation, obtained with a shot-speed video camera “Video Sprint” (Russia).

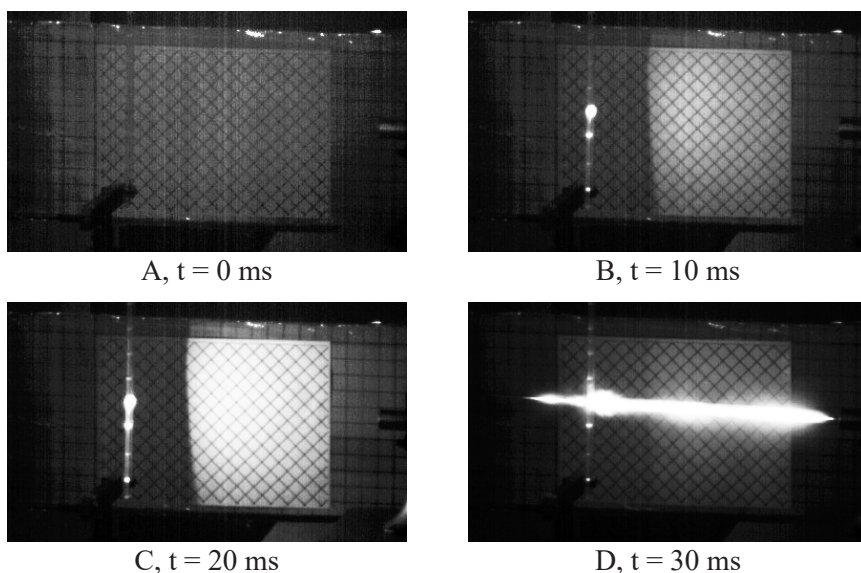
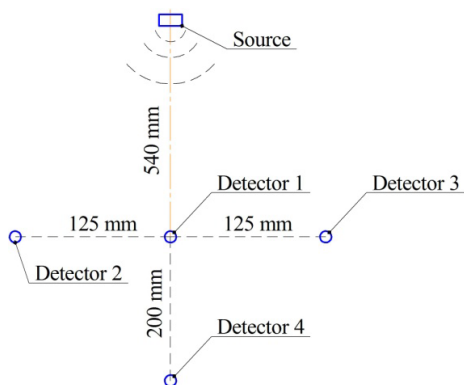

Figure 3. Storyboard of video recordings.

The speed shooting parameters for these experiments were 100 f/s at $100 \mu\text{s}$ exposure. A – the first photograph ($t=0$) shows that the luminescence from the laser diode is absent. B – the second photograph ($t=10$ ms) shows that there is a glow from the laser diode (note spot being reflected on the surface of the EC-2 formulation and on the surface of the Plexiglass board). C – the third photograph ($t=20$ ms) shows a bright glow from the source (note the increase in the reflection on the background screen). D – the fourth photograph ($t=30$ ms); the laser beam, being invisible when shooting, was rendered visible in the reflected light of the laser beam due to scattering of the explosion products (initiation had occurred).

Figure 4 shows the typical pressure levels of air shock waves obtained in the experiments with the initiation of the caps with EC-2 formulation by the LD beam using piezoelectric pressure sensors XCQ-080-5PSI (USA). Piezoelectric pressure sensors and the cap with the EC-2 formulation were located according to the scheme (Figure 4A).



A: Scheme for pressure measurement under laser initiation of the cap with the EC-2 formulation. Source – the cap with the EC-2 formulation, detectors 1, 2, 3, 4 – pressure sensors XCQ-080-5PSI.

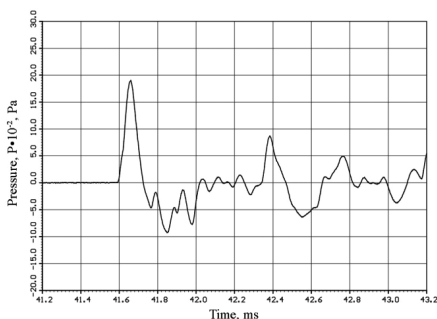

B: measurement by sensor 2.

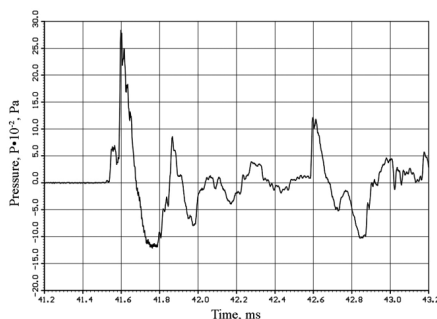

C: measurement by sensor 1.

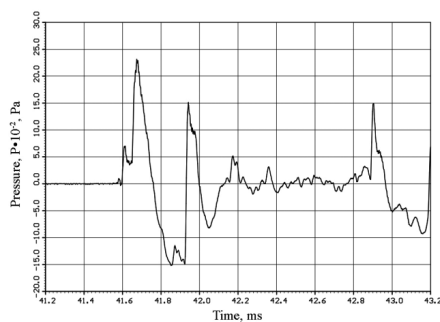

D: measurement by sensor 3.

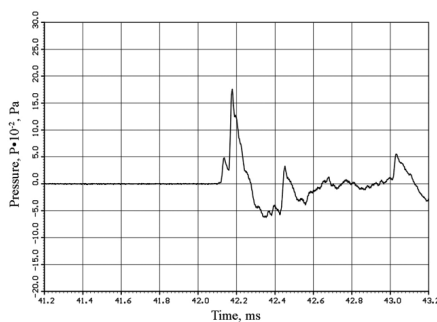

E: measurement by sensor 4.

Figure 4. Pressure of the air shock wave at different distances from the cap with the EC-2 formulation.

From Figure 4 it can be seen that the pressure levels in front of the air shock wave (compression phase) do not exceed 3 kPa (measurement by sensor 1) in about 50 cm in the direction of initiation. This fact indicates the relative safety of the construction being used in the experiments as a generator of weak

shock waves. Figure 4 also shows the lack of symmetry in the expansion of the detonation products (the difference in the parameters of the air shock waves in the areas of sensors 2 and 3). This fact may be indicative of a complex mechanism of explosion initiation in the light-sensitive composition EC-2, leading to asymmetric perturbations.

3.2 Initiation of formulation EC-2 through an optical fibre

The possibility of optical initiation of EC-2, which is out of the line of sight of the radiant, was demonstrated by using a 50 cm long flexible optical fibre with square inlet and outlet sections having 3 mm side. Figure 5 shows the general scheme of the experiment.

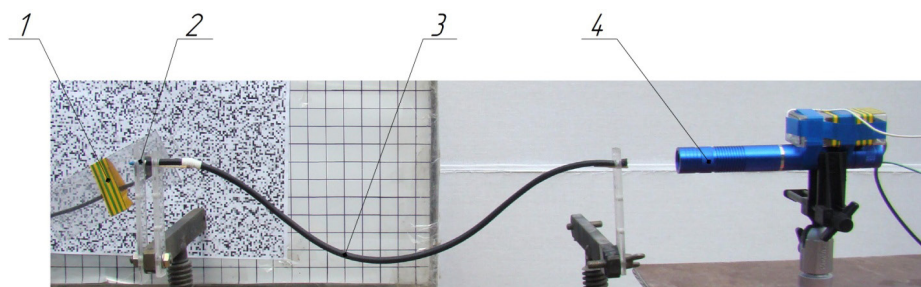

Figure 5. Scheme of the experiment: 1: photo-sensor is fixed on a plate of Plexiglass; 2: cap with EC-2 formulation; 3: optical fibre; 4: emitter setup.

The location of the optical fibre (remote input of radiation, a relatively large deflection) corresponds to the most stringent conditions for its potential applications. Loss of transmitted power from the laser diode due to aperture losses and the absorption of laser radiation in the optical fibre material were estimated to be at least 75%.

Figure 6 shows successive photographs of a high-speed video recording of the initiation of the EC-2 formulation in this scheme. The parameters of the speed camera “Video Sprint” (Russia) in the experiment were 2000 f/s at 100 μ s exposure. The laser diode was connected to the power supply through an operating circuit checking the pulse duration generated by the GP (see Figure 2). The pulse duration of the GP in the experiment was equal to 2 s.

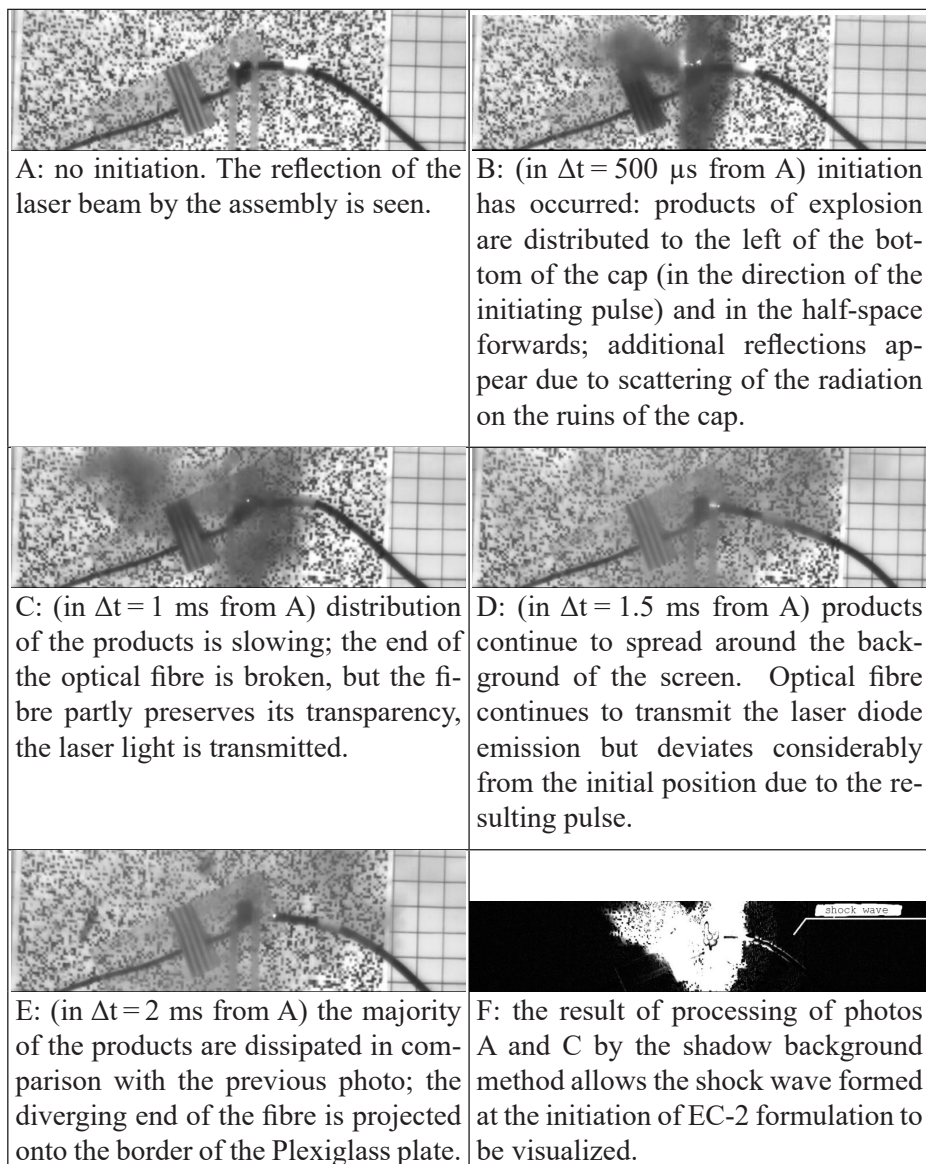

Figure 6. Storyboard of the video recording of the initiation of the EC-2 formulation in the experiment with an optical fibre.

The initiation time in the experiment, according to the video recording and the recording of the photosensor, was 408 ms.

Conclusion: while the power of the laser diode decreases from 1 W to less than 0.25 W, the initiation time increases from approximately 30 ms up to approximately 400 ms. The results demonstrate that the explosion of the EC-2 formulation occurs as a deflagration to detonation transition. Ignition of EC-2 begins in hot spots. Micro-inhomogeneities of the composition are probably the sources of these hot spots. The concentration of the hot spots depends on the power of the laser beam. The radiation from the LD probably causes changes in the optical characteristics of the EC-2 formulation in the process of initiation [2]. Additional experiments with double the length of optical fibre, having much greater absorption of visible light, have shown that the ignition of the EC-2 formulation occurs when the beam power of the LD is not more than 0.1 W.

3.3 Creation of the model optical detonator

To check the possible excitation of detonation in HEs, the light-sensitive formulation EC-2 was used. Detonation was initiated with the laser diode beam. Experiments were carried out according to the scheme shown in Figure 7.

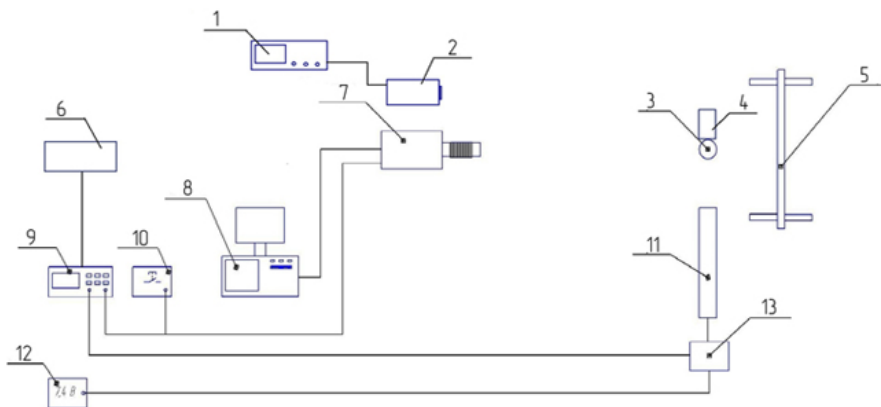

Figure 7. Installation diagram for the initiation of HEs.

1: oscilloscope; 2: photosensor; 3: cap containing EC-2; 4: container with HE; 5: screen; 6: delay unit; 7: speed video camera; 8: PC; 9: GP; 10: TTL; 11: laser diode setup; 12: PS; 13: key.

The following HEs were investigated: 1) PBX formulation (75% PETN and 25% polymer, detonation velocity $D = 7.8$ km/s, density $\rho_0 = 1.53$ g/cm³) which was in direct contact with the cap containing formulation EC-2, and 2) PETN (Russian Standard GOST V 22321-77 with a bulk density $\rho_0 = 1.0$ g/cm³) which was located in the detonating cord DShE-12 (Russian Standard GOST

6196-78). The PETN was initiated through the perforated protective cover of the cord DShE-12 (without direct contact with the cap's bottom, *i.e.* shooting the fragments of the cap body by the explosion products) (see Figure 8). In all of the experiments under the action of the laser beam, reliable initiation of the firing circuit elements in all of the experiments took place.

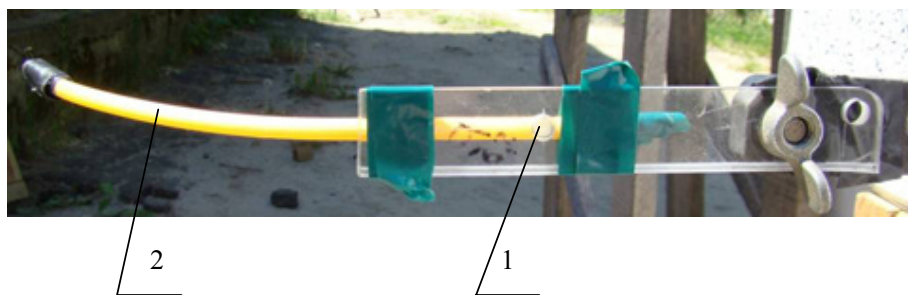
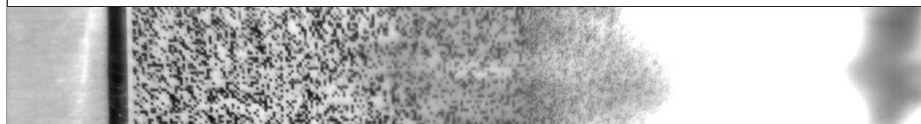

Figure 8. The assembly, including the cap with EC-2 (1), inserted into the mounting hole in the Plexiglass plate, and the detonating cord DShE-12 (2).

Figure 9 shows the video photographs of the process of initiation of the cord DShE-12 detonation. The photographs were obtained with the help of “Sprint Video” camera recording at 3000 f/s (exposure time 100 μ s) on the background screen.



Photograph 1. No initiation visible; projection of the assembly is visible (Figure 7) on the background screen.



Photograph 2. (Through $\Delta t \approx 333 \mu$ s after Photograph 1) – ignition of the EC-2 formulation and initiation of detonation in the cord has occurred – a powerful flash of light is visible due to the output of the products of explosion.

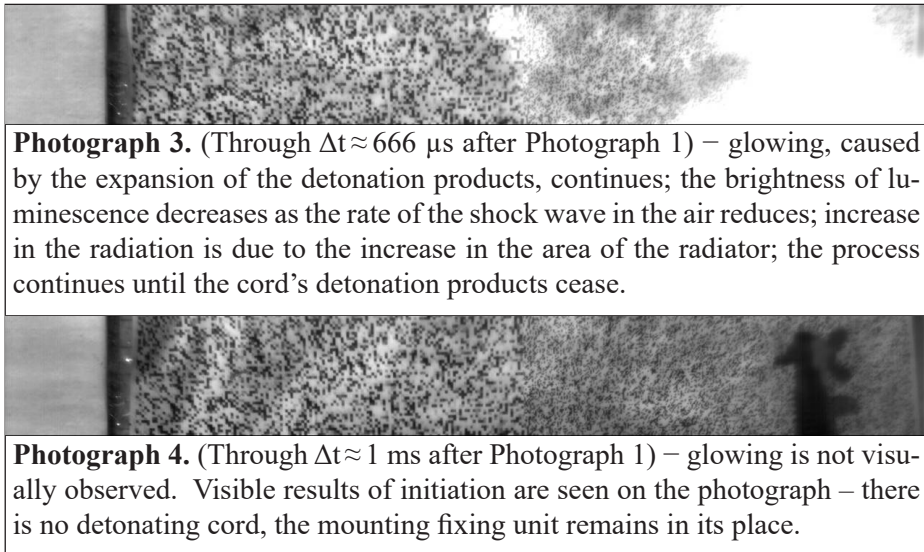

Figure 9. Video photographs of the process of detonation initiation in the cord DShE-12.

Figure 10 shows the oscillogram of the process of detonation initiation in the cord DShE-12 registered by a photosensor. A photodiode FD-24K (Russia) was used as the photosensor. It was included in the photodiode mode.

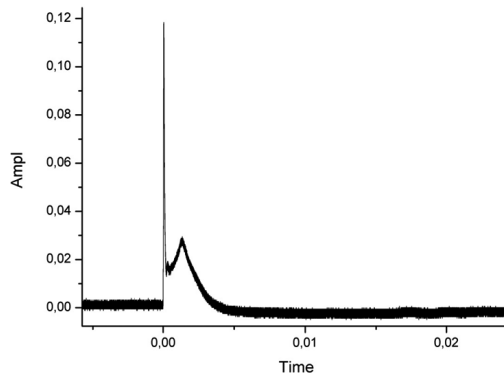

Figure 10. Characteristic signal profile obtained with the help of a photosensor at the moment of explosion of an elongated cylindrical charge – segment of the cord DShE-12.

The first peak in Figure 10 belongs to the initiation of EC-2 by the laser diode beam; the second peak belongs to radiation of the products of detonation

of the cord in their expansion process (see Figure 9, Photograph 3).

The results obtained with the help of the photosensor are fully consistent with the results of the video shoot obtained in the study of the detonation of HEs.

Fail-safe initiation of the caps with an LD beam and reliable transmission of the detonation to an HE gave the opportunity to construct and manufacture a model optical detonator (see Figure 11).

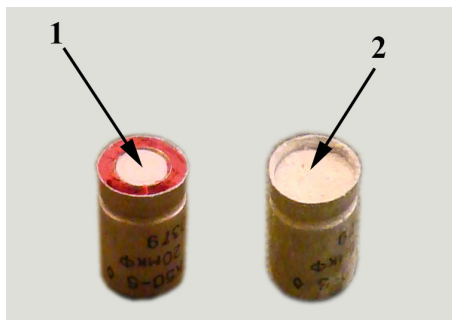

Figure 11. Photos of the model optical detonator (1) and the PETN charge (2).

The model OD was an aluminum shell that has been filled with 0.2 g of PETN [Figure 11 (2)]. The cap with the light-sensitive formulation EC-2 was fixed on the top of the shell [Figure 11 (1)]. Initiation of the model OD from a distance of 30-60 cm by a laser diode TO-56 (1 W) showed reliable operation for two dozen samples, with an average time of initiation less than 50 ms. The results of the operation of the detonator was confirmed by perforation of witness-plates having 5 mm thickness (aluminum alloy D-16).

Thus, these studies have shown the possibility of using polymer-containing energetic compositions based on the mercury perchlorate complex (EC-2 formulation) in ODs.

To reduce the operation time of the OD, the driving time of the metal perchlorate complex should be lowered through the use of more powerful radiation fluxes. In the visible range, such fluxes can be implemented using a pulse gas discharge light source with cumulative emitters.

3.4 Initiation of EC-1 and EC-2 formulations by cumulative light sources

The principle possibility of the initiation of energetic materials by cumulative light sources is known. For example, the results of model OD testing can be found in [21].

A mixture of 1,1,1,3,6,8,8,8-octanitro-3,6-diazoctane with aluminum

powder [grade UDKA (10%)] was used as the light-sensitive initiating charge. Pressed PETN was used as the secondary charge in the OD. Optical detonator testing was carried out by explosion of the light-sensitive EMs by irradiation with IFP-8000 flashbulbs, transmitting the energy to ODs with the help of flexible optical fibres of 1 mm diameter. The detonation of the OD was confirmed by extensive damage of the witness aluminum alloy D16 plate of 2 mm thickness. The experiments showed that the energy threshold of initiation of the OD was equal to 5.2 mJ. The initiation time of the OD depends on the value of the input energy and varied from 670 μs ($E = 5.2$ mJ) to 550 μs ($E = 6.4$ mJ). To reduce the time of OD initiation, initiating compounds more sensitive to strong light radiation should be used. EC-1 and EC-2 are such light-sensitive energetic formulations. The velocity of conversion of EC-1 and EC-2 formulations under the action of intense light was estimated by the impact of the explosion products of ODs on targets.

The free surfaces of pyroformulations of ODs were exposed to single light pulses of 2-3 μs duration. The results of the tests showed that explosions of EC-1 and EC-2 formulations equally took place (because there were a significant deformation of the plate-witnesses and mass loss of material of the targets from their surfaces in the contact area of the caps of the ODs with the targets). Product EC-2 is preferable for initiation of HEs, in comparison with product EC-1, as the energy evaluation in the case of EC-2 is much higher. The plates in contact with EC-2 were deformed more (Figure 12).

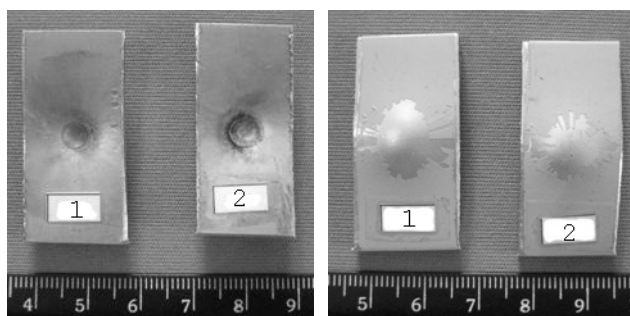

Figure 12. Views of witness plate surfaces (front and back) after the initiation of formulations EC-1 (1) and EC-2 (2).

Tests of the practical applicability of the EC-2 formulation for the initiation of HEs were performed with the help of PETN being part of the detonating cord DShE-12. Preliminary experiments have shown that the time of initiation of EC-2 under irradiation from a flash lamp IFC-500 does not exceed 30 μs [22]. The

installation scheme for the initiation process included a segment of detonating cord DShE-12, the OD (cap with EC-2 formulation) and the source of light – xenon flash lamp with energy storing element (75 J, operating voltage 30 kV). The detonating cord was placed on a witness plate of aluminum alloy D16 and fixed by transverse segments of adhesive tape (Figure 13).

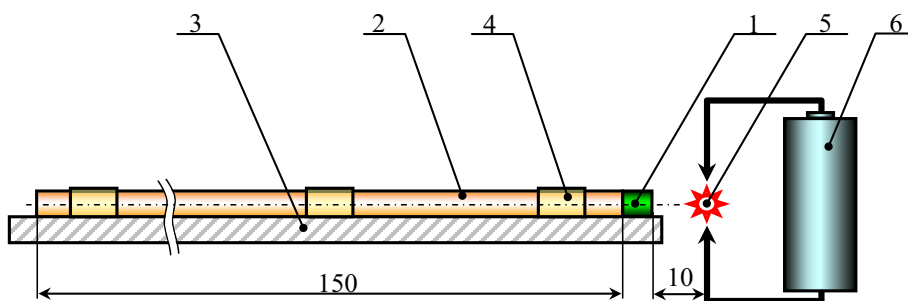

Figure 13. Scheme for the initiation of cord DShE-12 on a witness plate of aluminum alloy D-16. 1: product EC-2, 2: detonating cord DShE-12 according to standard GOST 6196-78 (detonation velocity $D=6200$ m/s), 3: witness plate (D-16, $\delta=5$ mm), 4: fixing elements (adhesive tape), 5: flash lamp IFC-500, 6: accumulator of electrical energy (75 J, 30 kV).

The outer surface of the brass cap of the OD was in contact with one of the cord ends. Single irradiation of the free surface of the light sensitive formulation was carried out with a flash lamp IFC-500 incorporated into the discharge circuit of an electrical energy accumulator. The distance between the light source and the EC-2 formulation was 10 mm. Initiation of the detonating cord DShE-12 resulted in the detonation pulse being distributed along the entire length of the detonating cord. A photograph of the witness plate after the experiment is shown in Figure 14.



Figure 14. View of the witness plate after initiation of cord DShE-12.

As can be seen from Figure 14, the trace of the detonation wave of the explosion products of cord DShE-12 (see black dent on the witness plate above the scale) corresponds to the length and width of the detonating cord DShE-12 segment (see its photograph below the scale). This result confirms the initiation of a stationary detonation in secondary energetic material PETN with the help of an OD, EC-2.

4 Conclusions

- Incoherent light radiation with energy 75 J and duration 2-3 μs causes an explosion of the pyrotechnic formulations EC-1 and EC-2 based on copper(II) and mercury(II) perchlorates complexes respectively.
- The EC-2 formulation, as a light-sensitive energetic material, being more powerful, is preferable to the EC-1 composition.
- Pyrotechnic formulation EC-2 can be used for the initiation of detonation in HEs by incoherent optical initiating radiation and radiation of a low-power laser diode.
- On the basis of the EC-2 formulation, a model optical detonator was created.

Acknowledgements

The work was performed under contract № 0406-2014 between Russian Federal Nuclear Centre – Russian Research Institute of Experimental Physics and Sarov’s Physics and Technical Institute RNU MIPhI. The technique was developed with the support of Russian Fund of Scientific Research, grant № 14-19-01637.

5 References

- [1] Ilyushin M.A., Tselinskii I.V., Laser Initiation of High-energy-capacity Compounds in Science and Technology, *Russ. J. Appl. Chem.*, **2000**, 73(8),1305-1312.
- [2] Tarzhanov V.I., Preexplosion Phenomena in Prompt Initiation of Secondary Explosives (Review), *Combust., Explos. Shock Waves (Engl. Transl.)*, **2003**, 39(6), 611-618.
- [3] Bourne N.K., On the Laser Ignition and Initiation of Explosives, *Proc. Roy. Society London, A*, **2001**, 457, 1401-1426.
- [4] Chernay A.V., Sobolev V.V., Chernay V.A., Ilyushin M.A., Bunchuk Yu.P., Ignition of Explosives by Pulse Lasers (in Russian), Ch. 11, in: *Physics of Impulse Treatment of Materials* (Sobolev V.V., Ed.), Dnepropetrovsk, Art-Press, **2003**, pp. 267-314; ISBN 966-7985-42-3.

- [5] Ilyushin M.A., Sudarikov A.M., Tselinsky I.V., Smirnov A.V., Chernay A.V., Shugalei I.V., *Metal Complexes in Energetic Formulations* (in Russian), (Tselinsky I.V., Ed.), A.S. Pushkin Leningrad State University, St. Petersburg, **2010**; ISBN 978-5-8290-0953-3.
- [6] Golubev V.K., Optical Initiation of Energetic Materials in Science and Technology. An Overview (in Russian), *Int. Conf. "Shock Waves in Condensed Matter"*, Kiev, Ukraine, 16-21 September, **2012**, 425-435; ISBN 978-966-085-3.
- [7] a) Cudzilo S., Szmigielski R., Synthesis and Investigation of some di-(R-1,2,4-triazolo)copper (II) Perchlorates (in Polish), *Biuletyn Wojskowej Akademii Technicznej*, **2000**, 49(12), 5-12; b) Ilyushin M.A., Tselinskiy I.V., Smirnov A.V., Shugalei I.V., Physicochemical Properties and Laser Initiation of a Copper Perchlorate Complex with 3(5)-Hydrazino-4-amino-1,2,4-triazole (HATr) as a Ligand, *Cent. Eur. J. Energ. Mater.*, **2012**, 9(1), 279-292.
- [8] Ilyushin M.A., Tselinsky I.V., *Method of Preparation of 5-Hydrazinotetrazole Mercury (II) Perchlorate* (in Russian), Russian Patent RU 2 225 840 C2, (Cl 7C01 G13/00), **2004**.
- [9] a) Ilyushin M.A., Ugryumov I.A., Dolmatov V.Ju., Veretennikova M.V., *Initiating Explosive Composition* (in Russian), Russian Patent RU 2 309 139 C2, (Cl C06B 43/00; C06B 45/30; C06C 7/00), **2006**; b) Chernay A.V., Ilyushin M.A., Sobolev V.V., Chernay V.A., *Primary Explosive Formulation* (in Ukrainian), Ukrainian Patent 52 997 C2, (Cl C06B 45/00), **2006**.
- [10] Ilyushin M.A., Petrova N.A., Tselinsky I.V., The Correlation between Thermal Decomposition and Laser Ignition Parameters for Complexes of HAT, *Hunneng Cailiao = Chin. J. Energ. Mater.*, **1993**, 1(4), 41-43.
- [11] Ilyushin M.A., Tselinsky I.V., Zhilin A. Yu., Ugryumov I.A., Smirnov A.V., Kozlov A.S., Coordination Complexes as Inorganic Explosives for Initiation Systems, *Hunneng Cailiao = Chin. J. Energ. Mater.*, **2004**, 12(1), 15-19.
- [12] Chernay A.V., Sobolev V.V., Chernay V.A., Ilyushin M.A., Dlugashek A., Laser Ignition of Explosive Compositions Based on Di-(3-hydrazino-4-amino-1,2,4-triazole)-copper(II) Perchlorate, *Combust., Explos. Shock Waves (Engl. Transl.)*, **2003**, 39(3), 335-339.
- [13] Ugryumov I.A., Ilyushin M.A., Tselinskii I.V., Kozlov A.S., Synthesis and Properties of Photosensitive Complex Perchlorates of *d*-Metals with 3(5)-Hydrazino-4-amino-1,2,4-triazole as Ligand, *Russ. J. Appl. Chem.*, **2003**, 76(3), 439-441.
- [14] Ilyushin M.A., Tselinskiy I.V., Smirnov A.V., Bachurina I.V., Ostashev V.B., Blagoveschenskiy V.V., Laser Initiation of Light-Sensitive Metal Complexes of 3-Hydrazino-4-amino-1,2,4-triazole (HATr) (in Russian), *Proc. SPbSIT (TU)*, **2012**, 13(39), 56-60.
- [15] Ilyushin M.A., Tselinsky I.V., Ugryumov I.A., Dolmatov V.Yu., Shugalei I.V., Study of Submicron Structured Energetic Coordination Metal Complexes for Laser Initiation Systems, *Cent. Eur. J. Energ. Mater.*, **2005**, 2(1), 21-33.
- [16] Ilyushin M.A., Tselinsky I.V., Bachurina I.V., Seidov E.Ya., Kozlov A.S., Korolev D.V., Olenin A.E., Laser Initiation of Complex Perchlorates of *d*-Metals

- with Heterocyclic Ligands , *Hunneng Cailiao = Chin. J. Energ. Mater.*, **2006**, 14(6), 401-405.
- [17] Ugryumov I.A., Ilyushin M.A., Tselinsky I.V., Study of Nanostructured Photosensitive Primary Explosives for Laser Initiation Systems, in: *Theory and Practice of Energetic Materials*, (Huang P., Li S., Wang Y., Eds.), **2003**, 5(B), 1151-1153.
- [18] Dilham D., Laser Diode Initiated Systems for Space Applications, *The First ESA-NASA Working Meeting on Optoelectronics: Fiber Optic System Technologies in Space*, ESA/ESTEC – October 6, **2005**, 1-10.
- [19] Lien Y., Thoen G., Grasvik O., Bru J., Paulsen K., Lierstuen L. O., Chamayou B., Pinard D., McKenzie I., Opto-pyrotechnics for Space Applications, *Int. Conf. Space Optics (ICSO)*, Rhodes, Greece, 4-8 October, **2010**, 1-4.
- [20] Hand C.F., Novel 300-watt Single-emitter Laser Diodes for Laser Initiation Applications, *Proc. SPIE 7795, Optical Technologies for Arming, Safing, Fuzing and Firing VI*, 779507, September 03, **2010**.
- [21] Gerasimov S.I., Faikov Yu.I., Kholin S.A., *Cumulative Light Sources* (in Russian), Sarov, RFNC-VNIIEF, **2002**, ISBN 5-85165-639-5.
- [22] Gerasimov S.I., Len A.V., Ilyushin M.A., Kalmykov P.N., Definition of Diversity for Ignition of Light-sensitive Pyrotechnic Composition Pellets with Roentgraphic Method, *New Trends Res. Energ. Mater., Proc. Semin., 14th*, Pardubice, Czech Republic, April 13-15, **2011**, Part 1, 160-162.

