

Jacek LUBIŃSKI\*, Michał WASILCZUK\*

## EXPERIMENTAL EVALUATION OF DLC/STEEL SLIDING CONTACTS' OPERATIONAL ENVELOPE

### DOŚWIADCZALNA OCENA DOPUSZCZALNYCH WARUNKÓW EKSPLOATACJI DLA ŚLIZGOWEGO SKOJARZENIA DLC/STAL

**Key words:**

sliding friction testing, tribometer, distributed contact, sliding friction, resistance to wear.

**Abstract**

In an industrial project concerning sliding bearings, a sliding pair was selected of high alloy steel vs. industrial grade DLC coated high alloy steel as a basis for an innovative design of high performance sliding bearings lubricated with a synthetic oil for use in geared transmission units. The development process required credible data on the ultimate resistance of the sliding pair to very high contact stress. An experimental evaluation was undertaken in ring-on-ring contact with an incremental semi-steady state input parameters increase. Due to restrictions in time, economy, and manufacturing, the number of specimen sets available was limited. A flexible approach to specimen use and load/velocity/time combinations was employed to deliver required test results within the available resource limitations and at constantly updated project detailed goals.

**Słowa kluczowe:**

badania tarcia ślizgowego, tribometr, styk konforemny, tarcie ślizgowe, odporność na zużycie.

**Streszczenie**

Przedstawiono przebieg i wyniki badań tarcia ślizgowego skojarzenia próbek ze stali wysokostopowej z powłoką DLC do zastosowań przemysłowych naniesioną na jedną ze stron skojarzenia. Badania stanowiły część prac związanych z rozwojem łożysk ślizgowych o wysokiej obciążalności jednostkowej, przeznaczonych do pracy w warunkach smarowania syntetycznym olejem przekładniowym. W toku prac rozwojowych konieczne okazało się uzyskanie danych na temat maksymalnej odporności powłoki na uszkodzenia przy bardzo dużych obciążeniach jednostkowych. Doświadczenia przeprowadzono w skojarzeniu płaskim, pierścieniowym przy semistacjonarnym wymuszeniu obciążeniem. Z uwagi na ograniczenia czasowe, finansowe i technologiczne związane z ograniczonymi możliwościami wytwarzania próbek, prace badawcze zrealizowano przy bardzo ograniczonej liczbie skojarzeń. Wykorzystano elastyczne podejście do wykorzystania próbek oraz zastosowanych w testach kombinacji obciążenie/prędkość/czas, aby zgromadzić dla partnera przemysłowego potrzebne wyniki w ramach dostępnych środków i przy ciągłych korektach szczegółowych celów podczas prowadzenia prac.

## INTRODUCTION

The design of bearing units for most demanding high load applications can exceed the typical procedure of evaluation based on load and velocity conditions, which leads to the selection of a roller element bearing or a sliding bearing. The latter is often of a design custom modified to suit a specific installation.

Typical contacts in sliding bearings (white metal, plastic) operate at surface pressures of up to 2 MPa in white metal lined bearings and even 11 MPa in PEEK lined bearings in full hydrodynamic mode in large and medium sized units. In highly loaded bearings of high speed and high output piston engines, the pressure may reach peak levels of 35 MPa [L. 1, 2]. Low and near zero velocity conditions are detrimental to the life of

\* Gdańsk University of Technology, Faculty of Mechanical Engineering, ul. G. Narutowicza 11/12, 80-001 Gdańsk, Poland.

hydrodynamic bearings, because of the loss of fluid film lubrication. That feature is an important limitation to their applicability in some machines. On the other hand, roller element bearings can suffer premature failure due to rapid changes in both load and rotational velocity as can be observed in machines subjected to such an erratic regime of operation. As an example, the current experience in wind turbine transmission failures can be given [L. 3] indicating the limitations of bearing type applicability and cases of the incomprehensibility of the proven design evaluation methods and models used for rolling bearing selection up until the present.

The technological barriers to sliding bearing applications are an incentive to seek new designs capable of filling the void on the boundary of sliding and rolling bearings' operational envelopes. In locations offering limited space and requiring high load capacity, the standard solutions might be unsatisfactory. However, it is hoped that steel vs. steel sliding bearings with one side of the contact coated with a layer of a hard, ceramic based compound can improve performance and broaden the applicability of sliding bearings.

One of the current subjects of interest in bearing technology is the performance of DLC based coatings in sliding against steel at high contact pressures lubricated with industrial grade oils. In certain applications subjected to random changes of load, it is believed that such sliding contacts can perform better than rolling contacts, which materialises in the need for fundamental research in the area. In many applications, especially in the renewable energy sector (e.g., wind turbines, and electrical generators propelled by sea waves) the load can change very rapidly at low velocity conditions. The bearings' resistance to seizure even at very high local contact stress and near zero sliding velocity is one of the limiting factors in the actual applicability of a given type of bearing. One of the potential futuristic paths for the development of sliding bearings for extreme conditions applications is a steel vs. DLC coated steel sliding bearing. The ceramic coating offers the potential benefits of seizure prevention at extremely high surface loading, even without full fluid lubrication. It is hoped that units of such type will find use as more reliable replacements for both rolling element bearings and classical sliding bearings in the currently problematic locations.

## CASE SPECIFIC RESEARCH REQUIREMENTS

The interaction between a scientific and an industrial establishment requires an effort on both parts. It is necessary to adapt procedures that allow fulfilling institution specific standard practice methodology requirements with both parties involved. The omnipresent need to maximise profit at minimum cost must be combined with the scientific requirement for test result credibility. This basic scientific approach is

well represented in numerous works on DLC coating testing and the methodology of tribological testing [L. 4–7].

In the presented case of the co-operation between a scientific institution and an industrial partner, the practical goal to be achieved can determine the framework of conduct in the experimental work.

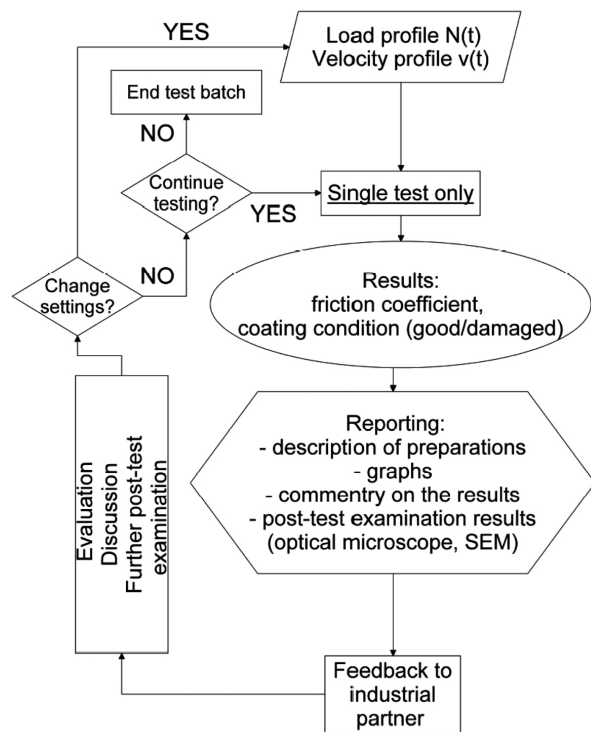

Fig. 1. Diagram of the test programme's stages and decision making points

Rys. 1. Schemat etapów programu badawczego i punktów podejmowania decyzji

The research was done in order to assess the general tribological performance of the sliding pairs involved, e.g., friction coefficient characteristics, wear resistance, and development; however, more importantly, it was needed to find the boundaries of coatings resilience to extreme load conditions. The decision making process with regard to both global and detailed testing needs had to be dynamically updated on the grounds of the current results. The testing procedure planning can be described as incremental and looped as shown in the flowchart in Fig. 1.

## THE TEST ENVIRONMENT

The test rig used for the research presented was a PT-3 Tribometer, which is a multipurpose tribological testing machine for experiments with unidirectional sliding or rolling contacts [L. 8, 9]. The machine was configured

for sliding friction tests in a flat-on-flat contact. The geometry of contact was ring vs. slotted ring (2 or 4 sections). Specimens are cylindrical with a ring offset on one of the pair and ring segments only machined into the face of the other specimen. The ring's segmentation was meant as a means of decreasing the overall contact surface area and increasing the maximum attainable contact stress. The specimens are located one over the other with the bottom one (non-rotating) mounted in a holder coupled with the friction torque sensor and supported in a self-aligning hydrostatic bearing. The load is applied through the bearing and transmitted to the sliding interface. The second specimen is attached to the machine's spindle driven by an AC motor. The output data set comprised the following: load, rotational velocity, friction torque, and the temperature of the lubricating oil and of the non-rotational specimen.

**Table 1. Contact surface basic geometry and attainable surface stress limit**

Tabela 1. Podstawowe cechy geometrii strefy styku próbek i obliczeniowa wartość maksymalna nacisków powierzchniowych

Specimen version	Contact surface area	Maximum achievable contact stress	Number of contact zones
[-]	[mm <sup>2</sup> ]	[MPa]	[-]
1	100	120	2
2	28	428	4

The tests were a means of evaluating the resistance to wear of the sliding pair of specimens manufactured of case hardened alloy steel (100CrMnSi6-4 steel, uncoated specimen, 18CrNiMo7-6 steel, coated specimen, both case hardened to 65 HRC) of which one of the specimens was coated with DLC. The main initial assumption was to find the maximum load/velocity combination allowable in the contact. The main attention was directed to the low velocity conditions, which represent the most difficult phase in the sliding system's use.

One of the limiting factors was the maximum load delivered by the PT-3 Tribometer in its current configuration:  $N = 12$  kN. The limitations resulting from the testing goals were applicable to the velocity of sliding, which was not to exceed  $v_{\max} = 1$  m/s. It was planned to reach a contact stress of  $p_{\max} > 100$  MPa, if the sliding surfaces of the specimens exhibited resistance to such high contact stress. The lubricating oil temperature was stabilised throughout the test at  $80 \pm 5^\circ\text{C}$ . The maximum temperature of the contact zone was by default limited to  $200^\circ\text{C}$ , because of the recommendations from the manufacturer of the oil – Castrol Optigear Synthetic X 320. That temperature was measured with the use of a thermocouple sensor embedded in a hole reaching to a distance of 1 mm below the non-rotational specimen.

A typical test was done at constant load and stepped velocity with an overall running time of 1 h 50 min.

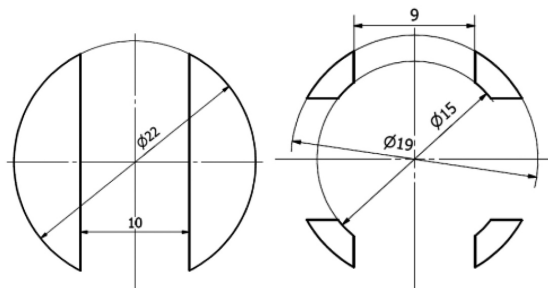

**Fig. 2. Specimens' contact surfaces: version 1 – left, version 2 – right**

Rys. 2. Powierzchnie styku próbek: wersja 1 – po lewej, wersja 2 – po prawej

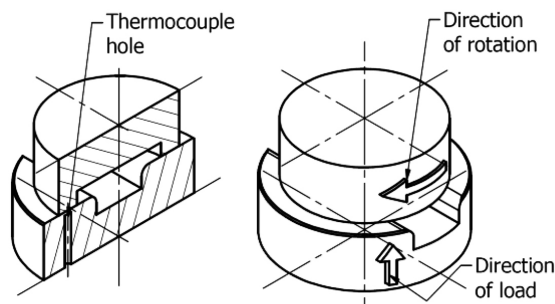

**Fig. 3. Specimens' arrangement in sectional (left) and axonometric (right) views**

Rys. 3. Układ próbek w przekroju (po lewej) i aksonometrii (po prawej)

## RESULTS EXAMPLES

As an illustration of the test progress and results, the load and velocity profile are presented in graphs in **Fig. 4**. A typical test was run at constant load applied gradually over 25 s to a set of specimens running at 15 RPM and stabilised later on. The velocity was gradually increased, starting at 15 RPM up to 100 RPM or 600 RPM in test runs at higher loads.

The decrease in sliding velocity was necessitated by the sliding contact's temperature limit. Apart from the post-test examination of the specimens as a means of evaluating the test results, the friction parameters were also analysed, including the friction coefficient changes with load and velocity, and the temperature profile. These results are shown in **Fig. 5** providing an interesting insight into the process. One of the more interesting observations is the possible development of mixed lubrication between the sliding surfaces manifested by a consistent decrease in the friction coefficient with the increase of sliding velocity.

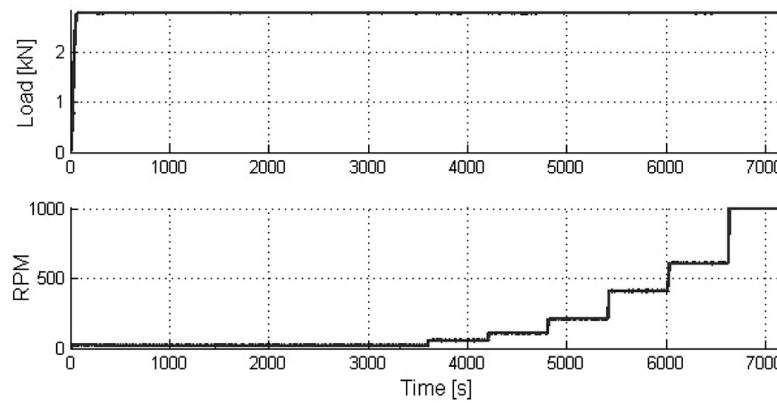

**Fig. 4. An example of a load and velocity profile in a test run up to 1000 RPM**

Rys. 4. Przykład typowego przebiegu obciążenia i prędkości podczas testu z prędkością obrotową do 1000 obr./min

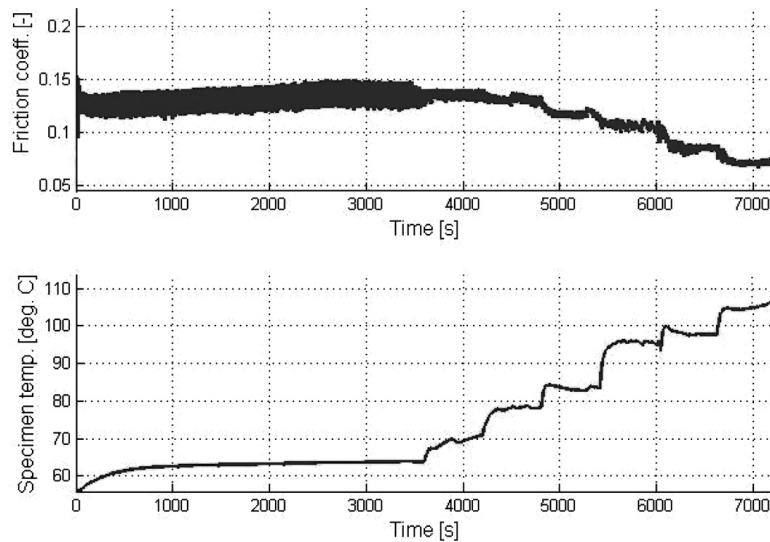

**Fig. 5. Friction coefficients and specimen temperatures in a stepped velocity test**

Rys. 5. Współczynnik tarcia i temperatura próbki podczas testu ze schodkowymi zmianami prędkości

During the testing, the velocity profile was kept unchanged, with the exception of the maximum velocity being reduced in highest load runs. The load (contact pressure) was gradually increased, and the final result was graded as “pass” or “not passed” on the basis of the coating being damaged or intact. The results were recalculated into a  $p_v$  factor and are presented as the maxima achieved in the graph in **Fig. 6**. The maximum values correspond to the conditions at which the coating’s surface was beginning to show visible damage (scratching or cracking) large enough to observe the steel substrate in optical microscopy. The results are, in general, very satisfactory with the coating performing consistently well throughout the range of inputs and reaching the resistance to damage in sliding friction beyond  $p_v = 100 \text{ MPa}^*(\text{m/s})$ .

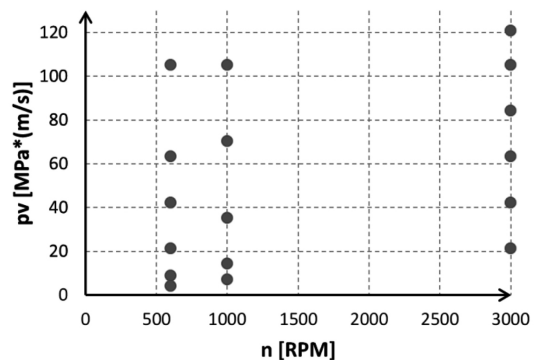

**Fig. 6. Maximum  $p_v$  values in individual tests at three levels of rotational velocity**

Rys. 6. Maksymalne wartości iloczynu  $p_v$  dla trzech prędkości obrotowych próbek

The criterion of damage to the coating was based on visual examination of the coated surface, and the coating was regarded as damaged if a portion was removed from at least one of the segments of the coated surface and the surface area of the portion was greater than 5% of the segment's overall surface area. The test was then repeated at least once to confirm the result. As one of the findings, it can be said that the coating was very consistently failing within a very narrow margin of input conditions and test times.

## DISCUSSION AND CONCLUSIONS

The result sought for was the information on the ultimate strength of the coating in sliding at high contact stress. Of secondary importance were the parameters of the tests, such as temperatures, friction coefficient profile, and the actual regime of the sliding friction (mixed, boundary).

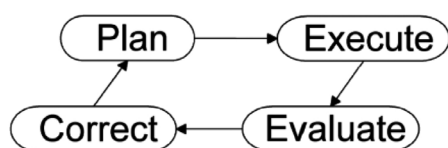

**Fig. 7. Decision making loop in the adaptive mode of experimental testing**

Rys. 7. Pętla decyzyjna w adaptatywnym trybie prowadzenia badań doświadczalnych

As one of the most important conclusions, it may be pointed out that the goal could be reached with a very limited number of test runs. The unique feature of the tests, as compared to common practice in scientific research, was a very narrowly defined objective, which influenced the process of testing. Tests were aimed directly at the practical needs of the application in which

the sliding contact is expected to operate under the harsh conditions of frequent start/stop cycles under high load. The flexible approach of both parties involved allowed overcoming the limitations of the testing environment (available load, specimen geometry, lubricant circulation, temperature stabilization, etc.) by continual adaptation of the team's actions following a simple decision making loop shown in **Fig. 7**, a derivative of John Boyd's classical OODA cycle (Observe Orient Decide Act) by which a concept of an inherently adaptive approach to complex tasks of both dynamic and repetitive nature is described [**L. 10**].

The co-operation routine established between the industrial partner and the academic research group, based on incremental testing and analysis of the partial results, allowed for a successful merger of the different ways of thinking represented by each of the partners. As a consequence, satisfactory results of the task could be achieved, and the developed method, allowing for economical completion of the research task, could be utilised in further planning and execution of tests with different material pairs.

The main conclusion resulting from the research conducted is that research tasks aimed at an industry related practical problem solution require a flexible approach of the scientific party. Test goal definition and program scripting are difficult to set in a rigid manner at the beginning of the task. Progress is incremental with continuous attention to cost, a primary factor, which results in a requirement for the number of tests to be limited to absolute practical minimum. The evaluation of the intermediate test results at every stage is done with the fundamental assumption of the necessity adaptive changes of the immediate goal of the next test and test's scope. Contrary to typical methodology, scientific testing of a range of parameters in an industrial project using the presented methodology specifies that the result of every test run is a decision making point for the conditions of the next run.

## REFERENCES

1. Michał W.: Hydrodynamic thrust bearings with polymer lining. *Tribologia*, 2016, pp. 225–237.
2. Scott R.: *Journal Bearings and Their Lubrication*. Machine and Lubrication, 2005, 7.
3. Gonçalves D., Graça B., Seabra J.: Rolling Bearing Failures In Wind Turbines, in: Proc. of the 5th Internat. Conf. on Integrity-Reliability-Failure, Porto/Portugal 24–28, July 2016, Editors J.F. Silva Gomes and S.A. Meguid, Publ. INEGI/FEUP, 2016, p. 407.
4. Madej M., Ozimina D.: Valuation of properties of DLC coatings applied in biotribological systems. *Tribologia*, 2009, 3, pp. 105–114.
5. Ozimina D., Madej M.: Assessing the properties of single and multi-layer DLC coatings. *Tribologia*, 2010, 2, pp. 119–135.
6. Madej M., Ozimina D.: The tribological properties of DLC coatings. *Tribologia*, 2012, pp. 95–102.
7. Kalbarczyk M., Michalczewski R., Szczerek M., Trzos M. et al.: Optimisation of test parameters influencing the dry friction of W-DLC coated elements. 2013, pp. 35–46.

8. Łubiński T., Druet K., Łubiński J.I.: Tribometr PT-3/96: Rozwój i zastosowanie. Zeszyty Naukowe Politechniki Gdańskiej, Mechanika, 1997.
9. Łubiński J.I., Neyman A., Sikora J.: Ocena odporności powłok na bazie DLC na doraźne uszkodzenie w warunkach tarcia ślizgowego ze smarowaniem wodą i solą fizjologiczną. Evaluation. Tribologia, 2009, 4, pp. 139–146.
10. Boyd J.R.: Destruction and creation, in: US Army Command and General Staff College, 1976, p. <http://www.goalsys.com/books/documents/DESTRUCTION>.