



ARCHIVES  
 of  
 FOUNDRY ENGINEERING

ISSN (2299-2944)

Volume 21

Issue 3/2021

19 – 26

10.24425/afe.2021.136108

3/3

Published quarterly as the organ of the Foundry Commission of the Polish Academy of Sciences

# Effect of Chip Amount on Microstructural and Mechanical Properties of A356 Aluminum Casting Alloy

A.Y. Kaya <sup>a,\*</sup>, O. Özaydın <sup>a</sup>, T. Yağcı <sup>b</sup>, A. Korkmaz <sup>b</sup>, E. Armakan <sup>a</sup>, O. Çulha <sup>b</sup>

<sup>a</sup>Cevher Alloy Wheels Co. / R&D Dept., İzmir, Turkey

<sup>b</sup>Manisa Celal Bayar University, Engineering Faculty, Dept. of Metallurgical and Materials Engineering, Manisa, Turkey

\* Corresponding author. E-mail address: ayigit.kaya@outlook.com

Received 09.03.2021; accepted in revised form 28.05.2021

## Abstract

Aluminum casting alloys are widely used in especially automotive, aerospace, and other industrial applications due to providing desired mechanical characteristics and their high specific strength properties. Along with the increase of application areas, the importance of recycling in aluminum alloys is also increasing. The amount of energy required for producing primary ingots is about ten times the amount of energy required for the production of recycled ingots. The large energy savings achieved by using the recycled ingots results in a significant reduction in the amount of greenhouse gas released to nature compared to primary ingot production. Production can be made by adding a certain amount of recycled ingot to the primary ingot so that the desired mechanical properties remain within the boundary conditions. In this study, by using the A356 alloy and chips with five different quantities (100% primary ingots, 30% recycled ingots + 70% primary ingots, 50% recycled ingots + 50% primary ingots, 70% recycled ingots + 30% primary ingots, 100% recycled ingots), the effect on mechanical properties has been examined and the maximum amount of chips that can be used in production has been determined. T6 heat treatment was applied to the samples obtained by the gravity casting method and the mechanical properties were compared depending on the amount of chips. Besides, microstructural examinations were carried out with optical microscopy techniques. As a result, it has been observed that while producing from primary ingots, adding 30% recycled ingot to the alloy composition improves the mechanical properties of the alloy such as yield strength and tensile strength to a certain extent. However, generally a downward pattern was observed with increasing recycled ingot amount.

**Keywords:** A356, Gravity casting, Chip melting, Mechanical properties, Recycling

## 1. Introduction

Environmental problems arising wherefore energy requirements are increasing day by day. Also, the increasing population and consumption are inevitably increasing the requirement of energy. This circumstance creates a loop in which the loser is nature. Recycling activities are very important to break this cycle. Owing to the activities include metals, plastics, and

glass, they concern a lot of sectors.

Considering the automotive industry, the growing demand for more fuel-efficient vehicles to reduce energy consumption and air pollution is a difficulty [1]. This necessity is led the manufacturers to make lighter vehicles. Precisely, for this reason, aluminum alloys are used due to their lightness, specific strength, corrosion resistance [2,3]. However, primary aluminum production is one of the most energy-intensive sectors in the industry. With the become prevalent use of aluminum alloys, sustainable energy

potential is increased. This is related to fact that aluminum alloys do not lose properties during the recycling process [4]. The amount of energy used for the production of one ton of aluminum is twice that of copper and polyethylene, and 5 times that of steel [5]. Because two-stage process called Hall-Héroult is used to produce aluminum from bauxite which is very problematic in terms of greenhouse gas emissions. More CO<sub>2</sub> needs to be produced than aluminum produced during this process. Greenhouse gases are also released into the nature in this process [6,7]. Instead of this process that has serious environmental damage, the treatment of aluminum scrap to produce new aluminum ingot and alloys is an alternative to primary aluminum production. The scraps include the metal of the end-of-life, like feeders and runners used during production, chips resulting from machining, and discards. The product created as a result of this process is called recycling of aluminum. The production of recycled aluminum is estimated to consume an energy amount between 5 and 7 GJ/ton due to recent improvements. Furthermore, one ton of recycled aluminum saves up to 14000 kWh of energy and the average total exhaust emission is about 350 kg of CO<sub>2</sub> [8]. Consequently, there are great energy savings to be made by recycling aluminum, and there is a significant environmental gain. The quality of the chemical composition of recycled aluminum alloys is highly important and can create negative impacts in the scenario of recycling [9]. Unfortunately, the barriers to mechanical properties limit the use of recycled aluminum. Impurities increase in recycled aluminum and this is the most important disadvantage compared to primary aluminum [10,11]. Imperfections include defects like porosity, intermetallics, Si, Fe, and Mn as well as oxides. Si can initiator for fracture, different types of Fe-rich intermetallics (like  $\alpha$ -Fe) affect the property in a negative direction, even though in Al-Si alloy systems, the positive effect of increasing the amount of Si up to the eutectic point on mechanical properties has been mentioned in literature [12, 13, 14]. In a similar study on the subject, an increased quantity of silicon and a similar increase in mechanical properties was observed in heat-treated samples [15]. But, intermetallics matter more than a slight amount of Si changes in terms of mechanical properties. Also, there are many of studies about effect of T6 heat treatment on mechanical properties of Al alloy. The influence of ageing temperatures and durations studied on A356 alloy. According to results, the effect of time was more visible than the temperature and the ageing treatment at 200°C for 90 minutes gave the optimum tensile properties [16,17]. On the top of that, short-time treatment studied and one of the best conditions was at 550°C for 2 hours regarding solutionizing conditions [18]. Intermetallics form by the reason of low solubility of Fe in the solid. Fe, which produces the most common intermetallics in recycled casting alloys, has a solubility in solid aluminum of about 0.03-0.05% at 655°C and even lower at room temperature [17]. Exactly can said that the scrap ratio increases, decreases the quality of molten metal [18]. However, Maoling et al. (2008) was studied magnesium alloys and concluded that the ambient oxide in the recycled sample contributes to a higher ultimate tensile strength and a higher elongation, but oversupply oxide in the recycled sample can negatively affect elongation to failure [19]. On the other hand, oxides and porosities are features in melt quality as well as mechanical property. So, using clean scrap due to scrap sorting becomes important. There are many types of scrap for aluminum products, which are called new scrap and old scrap [10]. Regarding

all the stages mentioned of produce recycling aluminum parts has become an efficient way.

In this study, the effect of the amount of chips in A356 aluminum cast alloy on the mechanical properties was investigated and the maximum amount of chips that can be used in production was determined. In addition, T6 heat treatment was applied to the samples obtained by gravity casting method and microstructural and mechanical properties were examined comparatively depending on the amount of chips.

## 2. Experimental Methods

The chips that came from wheel machining scraps cleaned from the metalworking fluid and specks of dirt by using the effect of centrifugal force and then melted in the molten metal bath afterward turned into ingot. These recycled ingots are called as ingots (Figure 1). As materials, the recycled and primary A356 (AlSi7Mg0.3) ingots were used in this study. At first, the ingots are cut as small as possible in order to melt easily for each primary and recycled ingot. Ingots were prepared 8 kg in total for each graphite crucibles and melted at 750±5°C. The alloys were prepared on a laboratory scale and no melt treatment processes (degassing, grain refinement, etc.) have been applied. Five different samples of charging were used given below in Table 1.

Table 1.  
Chips and primary ingot quantities

Sample No	Primary Ingot (%wt.)	Recycled Ingot (%wt.)	Primary Ingot (g)	Recycled Ingot (g)
1	100	-	8000	0
2	70	30	5600	2400
3	50	50	4000	4000
4	30	70	2400	5600
5	-	100	0	8000

Each sample was cast into permanent metallic mold. Meanwhile, the same mold temperature was provided for each casting in the sample zone of the permanent mold. On the other hand, chemical composition analysis was done by optical emission spectrometer (OES).



Fig. 1. Recycled ingots

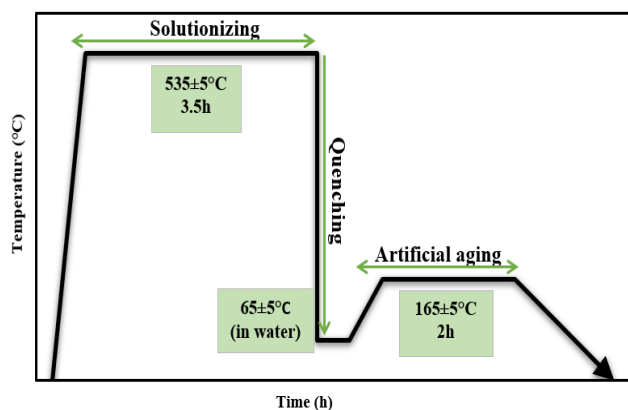


Fig. 2. T6 Heat treatment

T6 heat treatment (solutionizing, quenching in water and artificial aging) was applied to all samples at laboratory conditions due to simulate the mass production of the wheels' condition with these parameters given in Figure 2. Then, they were processed with reference to DIN 50125 for each condition in order to determine the yield and tensile strength values of the samples. The tensile tests were carried out at least 3 times for each sample by using Zwick Z100 model test machine according to PN-EN ISO 6892-1: 2020-05 [20,21].

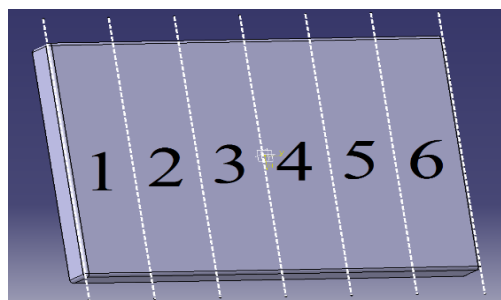


Fig. 3. Test sheet borders of permanent mold product

The permanent mold samples were machined to the sketched borders and machined into a tensile test specimen. The six specimens were sawn up from the cast samples in each casting as seen in Figure 3. Microstructural analyses of samples were carried out in a Nikon optical microscope by using Clemex image analysis software.

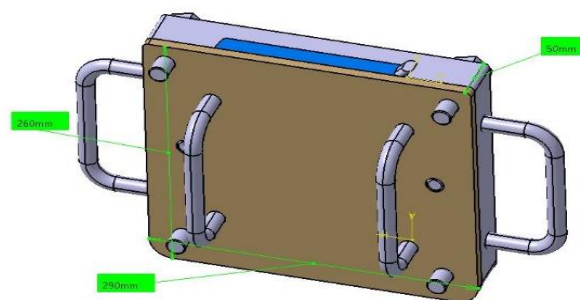


Fig. 4. Permanent Mold (290mm x 260mm x 50mm)

Table 2.

The chemical compositions of primary and recycled ingots (wt.%)

OES results	Alloying Elements (wt.%)								
	Samples	Si	Mg	Fe	Mn	Ti	Cu	Sr	Na
Primary ingot	7.25	0.28	0.100	0.002	0.11	0.001	0.023	0.0006	Bal.
Recycled ingot	7.35	0.27	0.125	0.003	0.11	0.001	0.007	0.0003	Bal.
100% Primary ingot	7.25	0.28	0.104	0.002	0.11	0.001	0.015	0.0004	Bal.
70% Primary ingot + 30% recycled ingot	7.14	0.27	0.104	0.002	0.11	0.001	0.011	0.0003	Bal.
50% Primary ingot + 50% recycled ingot	7.20	0.26	0.114	0.002	0.11	0.001	0.010	0.0003	Bal.
30% Primary ingot + 70% recycled ingot	7.32	0.26	0.118	0.002	0.11	0.001	0.007	0.0003	Bal.
100% Recycled ingot	7.34	0.26	0.123	0.002	0.11	0.001	0.005	0.0004	Bal.

### 3. Results and Discussion

Table 2 is created according to chemical composition analysis

results of the ingots and samples that were measured by optical emission spectrometer.

In the microstructural analysis performed under the optical

microscope (OM) with image analysis software, high resolution microstructure images with different magnifications (50x, 100x, 200x) were recorded from each sample as seen in Figure 4. In addition, analysis of phase ratios based on  $\alpha$ -Al and eutectic silicon in the samples was also carried out. The phase analyses images and results of the samples were given in Figure 5. Accordingly, 89.13%  $\alpha$ -Al phase (red regions) and 10.86% eutectic silicon phase (blue regions) were found in the microstructure in sample 1. In sample 3 cast by mixing equal amounts of primary and recycled ingots,

83.79%  $\alpha$ -Al phase and 16.21% eutectic silicon phase were observed. For sample 5 with 100% recycled ingot, 82.05%  $\alpha$ -Al and 17.95% eutectic silicon phase ratios appear. Also, microstructures exhibit similar properties in terms of the size of the  $\alpha$ -Al dendrites and arm spacings. On the other hand, as the amount of recycled ingot in the alloy increases, inclusions that are thought to have oxide content are encountered in the microstructure. This condition appears as dark colored (black) regions in micrographs.

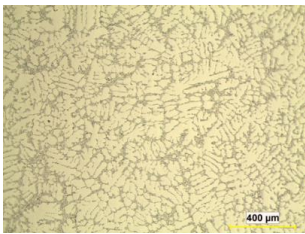
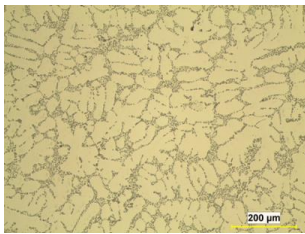
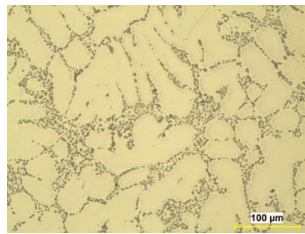
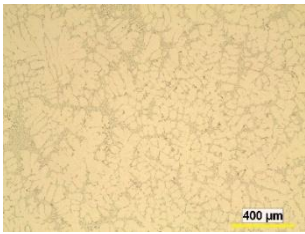
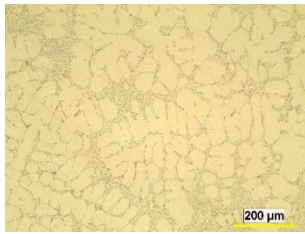
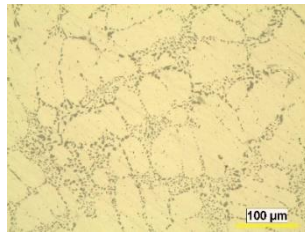
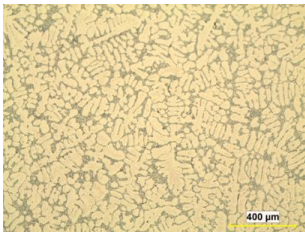
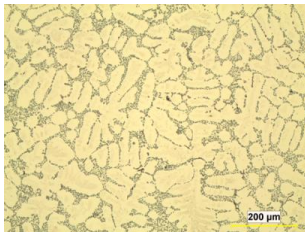
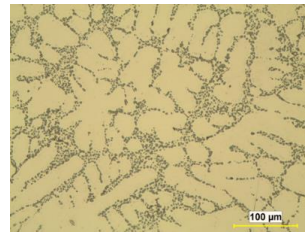
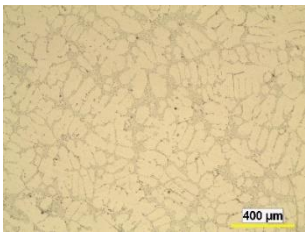
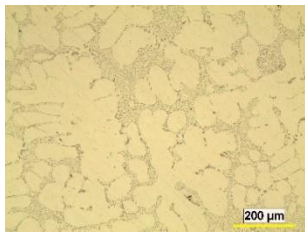
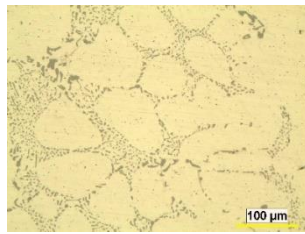
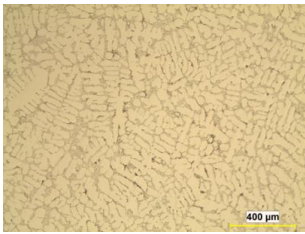
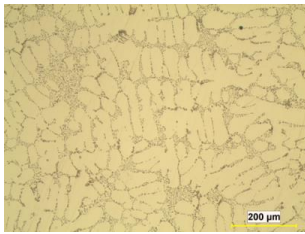
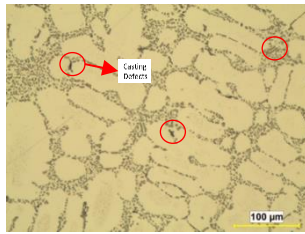
OM	Optical magnification		
Sample	50x	100x	200x
1			
2			
3			
4			
5			

Fig. 5. Optical microscope images of the samples at different magnifications

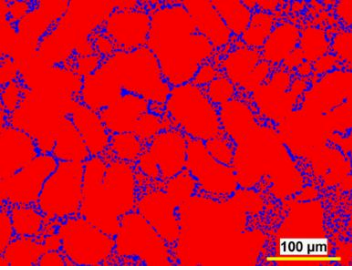
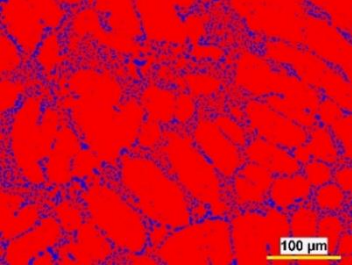
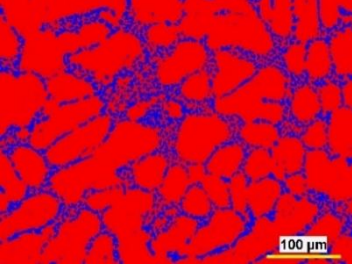
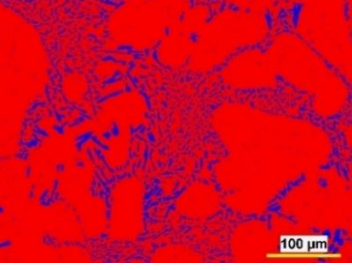
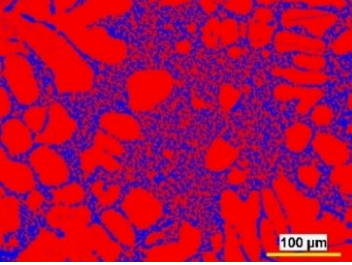
Sample	Phase Analysis Images (200x)	Results (%)	
		$\alpha$ -Al	Eutectic Si
1		89.13	10.86
2		87.62	12.37
3		83.79	16.21
4		88.53	11.46
5		82.05	17.95

Fig. 6. Phase analysis images and results of the samples

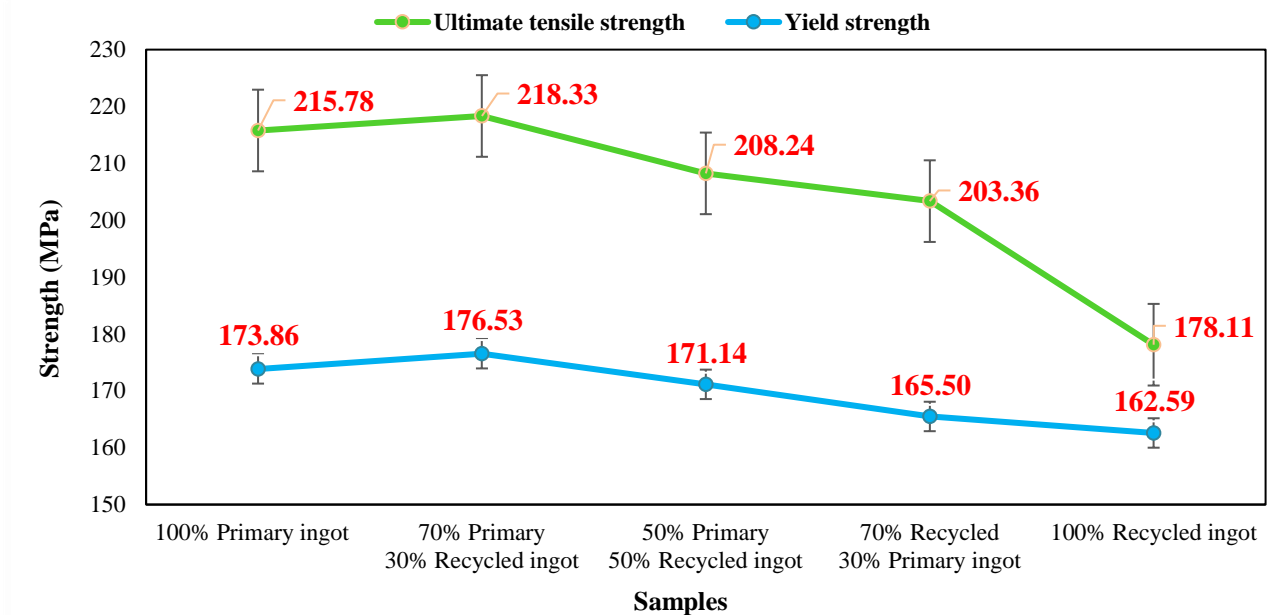


Fig. 7. Yield strength and ultimate tensile strength values of the samples

The decreasing trend was observed between sample 1 (100% primary ingot) and sample 5 (100% recycled ingot). A sudden rise that was observed in the sample 2 (70% primary + 30% recycled ingot).

Similar to the yield strength graph, the decreasing trend was observed between sample 1 (100% primary ingot) and sample 5 (100% recycled ingot). However, an immediate rise in the sample 2 (70% primary + 30% recycled ingot) and sharp descend were observed in sample 5 (100% recycled ingot).

It has been thought that the Si amount coming from recycled aluminum ingot causes slight fluctuation in chemical composition. However, the quantity of Si is acceptable for each sample and it can not be responsible for mechanical changes. In this study, recycled ingot contained more Fe, and also amount of Fe increased with recycled ingot quantity. Fe content of primary ingots is around 0.10%, this value reaches 0.123% in recycled ingots. Although the difference is small, it is clear from the mechanical results that this

value is critical for aluminum casting alloys. Fe element causes the formation of intermetallic compounds in aluminum alloys that will negatively affect the mechanical properties. In order to prevent this negative effect, certain amounts of Mn are added to aluminum alloys. As seen in Table 2, the amount of Mn does not change despite the increasing amount of recycled ingot. On the other hand, it would be correct to state that the Fe/Mn ratio, which should be preserved, deviates, as Fe increases, causing a negative effect on the mechanical properties [22,23]. In other respects, recycled ingots can contain more oxide and H pores than primary ingots. Although the amount of hydrogen is not considered as the main reason for the decrease in mechanical properties, increasing Fe content and oxides can explain the decrease in mechanical properties. The sharp drop in UTS in sample 5, which includes only recycled ingots, also supports this situation [24, 25, 26].

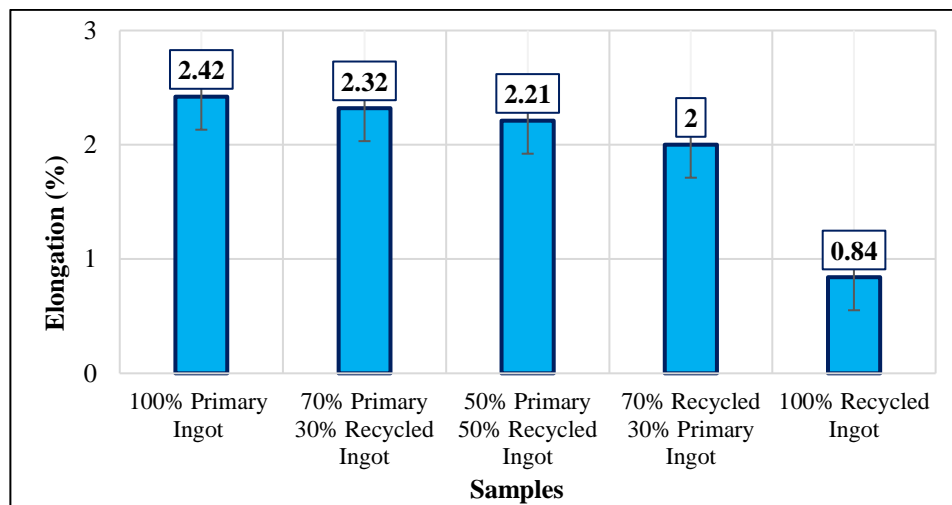


Fig. 8. Elongation values of the samples (%)

A decreasing trend of elongation was observed due to the increase of recycled ingot amount in alloy. A sudden descend was observed in the sample 5. It has been thought that the presence of recycled ingots' Fe content in alloy and impurities (eg. oxides) affected the elongation values as negatively. Iron-containing intermetallics increases with iron content. Therefore these intermetallics influence the fracture mechanism so elongation might be affected by Fe content [27,28]. In this study, unlike the manufacturing scale production, degassing, grain refinement or modification were not performed. For this reason, the molten metal was poured into permanent molds without any treatment and samples were obtained for examination. This study, which will be an important reference in recycling, will be repeated in the next trials by applying molten metal processes, which are indispensable in aluminum casting, in order to further detail the work and bring this process closer to real production. In melting and casting applications of aluminum alloys, any discontinuity in the structure, whether a hard, soft, brittle, gas or vapour phase, will impair the desired properties to some degree [29]. In this way, it is expected that the dark colored oxides and porosities encountered in microstructural examinations, which are characterized as casting defects, will decrease and the mechanical properties will improve accordingly.

## 4. Conclusion

In microstructural phase ratio analyzes performed using optical microscope, the highest  $\alpha$ -Al and the lowest eutectic-Si phase ratios were observed in sample that containing 100% primary ingot. The eutectic-Si phase ratio increased with the increasing amount of recycled ingot contained in the casting alloy and reached its highest in samples containing 100% recycled ingot.

The 1.5% increase in yield strength was observed in the 70% primary + 30% recycled ingot sample compared to the 100% primary ingot sample. YS has not increased in any other sample. After the 70% primary + %30 recycled ingots sample a downtrend was observed with increasing recycled ingot amount. As a result of the downtrend, a 9% decrease in YS in 100% recycled ingot sample

compared to 70% primary + 30% recycled ingot sample was observed.

The 1.2% increase in ultimate tensile strength was observed in the 70% primary + 30% recycled ingot sample compared to the 100% primary ingot sample. After the 70% primary + %30 recycled ingots sample a downtrend was observed with increasing recycled ingot amount similarly to YS graph. A sharp decrease was observed in 100% recycled ingot sample. Result of the downtrend between 70% primary + 30% recycled ingot and 100% recycled ingot samples, an 18.4% decrease in UTS was observed.

Not only a descend was observed in elongation between 100% primary ingot and 30% primary + 70% recycled ingot samples but also a sudden drop was observed in 100% recycled ingot sample.

Due to the higher amount of Fe and oxide in recycled ingots, the increased amount of recycled ingot in alloys causes adverse effects on mechanical properties such as tensile and yield strength and elongation values.

## Acknowledgment

We would like to show our gratitude to Manager of Metallurgical Laboratory Ali İLERİ, and all the metallurgical laboratory employees for support this study.

## References

- [1] Miller, W.S., Zhuang, L., Bottema, J., Wittebrood, A.J., Smet, P. De., Haszler, A. & Vieregge, A. (2000). Recent development in aluminium alloys for the automotive industry. *Materials Science and Engineering: A*. 280, 37-49. doi.org/10.1016/S0921-5093(99)00653-X
- [2] Cagan, S.C., Venkatesh, B. & Buldum, B.B. (2020). Investigation of surface roughness and chip morphology of aluminum alloy in dry and minimum quantity lubrication machining. *Materials Today: Proceedings*. 27, 1122-1126. doi.org/10.1016/j.matpr.2020.01.547

- [3] Naumova, E.A., Belov, N.A. & Bazlova, T.A. (2015). Effect of heat treatment on structure and strengthening of cast eutectic aluminum alloy Al9Zn4Ca3Mg. *Metal Science and Heat Treatment*. 57, 5-6. doi.org/10.1007/s11041-015-9874-6
- [4] Krolo, J., Gudić, S., Vrsalović, L., Branimir, L., Zvonimir, D. (2020). Fatigue and corrosion behavior of solid-state recycled aluminum alloy EN AW 6082. *Journal of Materials Engineering and Performance*. 29(7), 4310-4321. doi.org/10.1007/s11665-020-04975-8
- [5] TMMOB Metalurji Mühendisleri Odası, Alüminyum Komisyonu, Alüminyum Raporu.
- [6] Dhindaw, B.K., Aditya, G.S.L. & Mandal, A. (2020). Recycling and downstream processing of aluminium alloys for automotive applications. In Saleem Hashmi and Imtiaz Ahmed Choudhury (Eds.), *Encyclopedia of Renewable and Sustainable Materials*. 3 (pp.154-161). Elsevier Inc.
- [7] Grjotheim, K., Krohn, C., Malinovsky, M., Matiasovsky, K., Thonstad, J. (1982). *Aluminium electrolysis: Fundamentals of the Hall-Heroult Process*. 2nd Edition. University of California.
- [8] Peng, T., Ou, X., Yan, X. & Wang, G. (2019). Life-cycle analysis of energy consumption and GHG emissions of aluminium production in China. *Energy Procedia*. 158, 3937-3943. doi.org/10.1016/j.egypro.2019.01.849
- [9] Prasada Rao, A. K. (2011). An approach for predicting the composition of a recycled Al-Alloy. *Transactions of the Indian Institute of Metals*. 64, 615-617. doi.org/10.1007/s12666-011-0084-7
- [10] Capuzzi, S. & Timelli, G. (2018). Preparation and melting of scrap in aluminum recycling: A Review. *Metals*. 8(4), 249. doi.org/10.3390/met8040249
- [11] Khalid, S.N.A.B. (2013). *Mechanical strength of as-compacted aluminium alloy waste chips*. Malaysia: MSc Thesis, Universiti Tun Hussein Onn Malaysia.
- [12] Bjurenstedt, A. (2017). *On the influence of imperfections on microstructure and properties of recycled Al-Si casting alloys*. Sweden: PhD. Thesis, Jönköping University Jönköping.
- [13] Bogdanoff, T., Seifeddine, S. & Dahle, A. K. (2016). The effect of Si content on microstructure and mechanical properties of Al-Si alloy. *La Metallurgia Italiana*. 108(6), 65-69.
- [14] Wang, Y., Liao, H., Wu, Y. & Yang, J. (2014). Effect of Si content on microstructure and mechanical properties of Al-Si-Mg alloys. *Materials & Design*. 53, 634-638.
- [15] Ozaydin, O. & Kaya, A. (2019). Influence of different Si levels on mechanical properties of aluminium casting alloys. *European Journal of Engineering And Natural Sciences*. 3(2), 165-172.
- [16] Zhang, X., Ahmmed, K., Wang, M. & Hu, H. (2012). Influence of aging temperatures and times on mechanical properties of vacuum high pressure die cast aluminum alloy A356. *Advanced Materials Research*. 445, 277-282. doi.org/10.4028/www.scientific.net/AMR.445.277
- [17] Ozaydin, O., Dokumaci, E., Arman, E., Kaya, A. (2019). The effects of artificial ageing conditions on a356 aluminum cast alloys. In ECHT 2019 - European Conference on Heat Treatment. Bardolino, Italy.
- [18] Peng, J., Tang, X., He, J. & Xu, D. (2011). Effect of heat treatment on microstructure and tensile properties of A356 alloys. *Trans. Nonferrous Met. Soc. China*. 21, 1950-1956. DOI: 10.1016/S1003-6326(11)60955-2
- [19] Wang, L., Makhlof, M. & Apelian, D. (2013). Aluminium die casting alloys: alloy composition, microstructure, and properties-performance relationships. *International Materials Reviews*. 40(6), 221-238. doi.org/10.1179/imr.1995.40.6.221
- [20] Yuksel, C.K., Tamer, O., Erzi, E., Aybarc, U., Cubuklusu, E., Topcuoglu, O., Cigdem, M. & Dispinar, D. (2016). Quality evaluation of remelted A356 scraps. *Archives of Foundry Engineering*. 16(3), 151-156. DOI: 10.1515/afe-2016-0069
- [21] Hu, M., Ji, Z., Chen, X. & Zhang, Z. (2007). Effect of chip size on mechanical property and microstructure of AZ91D magnesium alloy prepared by solid state recycling. *Materials Characterization*. 59(4), 385-389. doi.org/10.1016/j.matchar.2007.02.002
- [22] Testing Of Metallic Materials – Tensile Test Pieces, Prüfung Metallischer Werkstoffe – Zugproben Deutsche Norm DIN 50125, 2016.
- [23] Metallic Materials - Tensile Testing - Part 1: Method Of Test at Room Temperature, PN-EN ISO 6892-1: 2020-05
- [24] Taylor J.A. (2012). Iron-containing intermetallic phases in Al-Si based casting alloys. *Procedia Materials Science*. 1, 19-33. doi.org/10.1016/j.mspro.2012.06.004
- [25] Eisaabadi, G.B., Davami, P., Kim, S.K., Varahram, N., Yoon, Y.O. & Yeom, G.Y. (2012). Effect of oxide films, inclusions and Fe on reproducibility of tensile properties in cast Al-Si-Mg alloys: Statistical and image analysis. *Materials Science and Engineering: A* 558, 134-143. doi.org/10.1016/j.msea.2012.07.101
- [26] Schlesinger, M.E. (2013). *Aluminum Recycling*. CRC Press. 2nd Edition. CRC Press
- [27] Dispinar, D., Akhtar, S., Nordmark, A., Sabatino, M. Di. & Arnberg, L. (2010). Degassing, hydrogen and porosity phenomena in A356. *Materials Science and Engineering: A*. 527(17), 3719-3725. doi.org/10.1016/j.msea.2010.01.088
- [28] Akhtar, S., Dispinar, D., Arnberg, L. & Sabatino, M.Di. (2009). Effect of hydrogen content melt cleanliness and solidification conditions on tensile properties of A356 alloy. *International Journal of Cast Metals Research*. 22(4), 22-25. doi.org/10.1179/136404609X367245
- [29] Bösch, D., Pogatscher, S., Hummel, M., Fragner, W., Uggowitzer, P.J., Göken, M. & Höppel, H.W. (2015). Secondary Al-Si-Mg high-pressure die casting alloys with enhanced ductility. *Metallurgical and Materials Transactions A*. 46(3), 1035-1045.
- [30] Taylor, J.A. (2004). The effect of iron in Al-Si casting alloys. In 35th Australian Foundry Institute National Conference, 31 Oct - 3 Nov 2004 (148-157). Australia: Australian Foundry Institute (AFI).
- [31] Campbell, J. (1993). *Castings*, 2nd Edition. Elsevier.