

# INVESTIGATION METHOD AND MATHEMATICAL MODEL OF PRESSURE LOSSES IN HYDRAULIC ROTARY MOTOR

Agnieszka Maczyszyn

Gdańsk University of Technology, Poland

## ABSTRACT

*This paper presents a way of determining the coefficient  $k_8$  of the pressure losses  $\Delta p_{Mp}$  (flow drag) in internal ducts of SWSB-63 hydraulic motor. The coefficient is determined at a flow rate equal to the theoretical capacity  $Q_{p1}$  of the pump feeding the motor, the losses are related to the nominal pressure  $p_n$  in the hydraulic system. The investigations followed a model of energy performance of hydraulic rotary motor, proposed by Z. Paszota.*

**Keywords:** hydrostatic drive, power values of energy losses, hydraulic rotary motor, pressure losses, pressure efficiency

## INTRODUCTION

Basic units of hydraulic systems are : drive and control systems. Drive systems are composed of pump units serving as converters of mechanical energy into liquid flow energy, units of hydraulic motors serving simultaneously as consumers of liquid flow energy and converters of the energy into mechanical one, as well as control units, e.g. those controlling motion speed or direction. The three groups are mutually connected by conduits and supplemented by auxiliary units.

The hydraulic rotary motors are used in hydrostatic drives which – in case of marine applications – can transfer large amounts of power and simultaneously have compact structure resulting in a small area required for their location on deck. This is one of many advantages of hydrostatic drive.

The pressure losses  $\Delta p_{Mp}$  in internal ducts of hydraulic motor have a great influence on total efficiency of displacement machine, which in turn impacts working parameters of hydrostatic system.

Pressure losses constitute drag of working medium flow through internal ducts and distributor of displacement machine, hydraulic motor in this case. Geometry of the ducts

is characteristic for a given design solution. The losses  $\Delta p_{Mp}$  in the motor result to a large degree from local pressure losses which arise from changes in flowing flux direction and velocity. The pressure losses  $\Delta p_{Mp}$  depend mainly on the flow rate  $Q_M$  of oil and its viscosity  $\nu$  [7].

The pressure losses  $\Delta p_{Mp}$  can be expressed as follows :

$$\Delta p_{Mp} = \Delta p_{Mp1} + \Delta p_{Mp2} = f(Q_M, \nu) \quad (1)$$

where:

$\Delta p_{Mp1}$  - pressure losses in inlet duct ( occurring between liquid inflow point to hydraulic motor and working chambers);

$\Delta p_{Mp2}$  - pressure losses in outlet duct (occurring between working chambers and liquid outflow point from hydraulic motor).

In general, the pressure losses power  $\Delta P_{Mp}$  is the product of the pressure loss  $\Delta p_{Mp}$  and liquid flow rate  $Q_M$ , namely:

$$\Delta P_{Mp} = \Delta p_{Mp} Q_M \quad (2)$$

The power  $\Delta P_{Mp}$  of pressure losses in hydraulic motor is sum of the power  $\Delta P_{Mp1}$  of pressure losses in inlet duct and the power  $\Delta P_{Mp2}$  of pressure losses in outlet duct of the motor :

$$\Delta P_{Mp} = \Delta P_{Mp1} + \Delta P_{Mp2} \quad (3)$$

As a result, the formula describing the power  $\Delta P_{Mp}$  of pressure losses in hydraulic motor takes the form as follows :

$$\Delta P_{Mp} = \Delta P_{Mp1} + \Delta P_{Mp2} = \Delta p_{Mp1} Q_M + \Delta p_{Mp2} Q_{M2} \quad (4)$$

In rotary motor in which the liquid flow rate  $Q_{M2}$  in outlet duct is practically equal to the liquid flow rate  $Q_M$  in inlet duct (i.e. the motor absorbing capacity  $Q_M$ )  $\rightarrow Q_{M2} = Q_{M1} = Q_M$ , the pressure losses power  $\Delta P_{Mp}$  in the motor takes the form:

$$\Delta P_{Mp} = (\Delta p_{Mp1} + \Delta p_{Mp2}) Q_M = \Delta p_{Mp} Q_M \quad (5)$$

## KNOWN METHODS FOR DESCRIPTION OF PRESSURE LOSSES

The pressure losses  $\Delta p_{Mp}$  in ducts presented in Fig. 3 make it possible to determine the value of the exponent  $a_{vp}$  equal to  $\sim 0,25$  for the motor absorbing capacity  $Q_{Mt}$ . The obtained value allows to state that we deal with a not fully developed flow. It can be confirmed by the fact that, according to the Darcy-Weisbach formula for fully developed turbulent flow, the expression for pressure losses is of the following form:

$$\Delta p = \lambda \frac{l \rho v^2}{d \cdot 2} \quad (6)$$

where:

- $\lambda$  - stands for linear drag coefficient which varies depending on value of Reynolds number (Re),
- $l$  - the length of the pipe [m];
- $d$  - diameter of the pipe [m];
- $\rho$  - fluid density [kgm<sup>-3</sup>],
- $v$  - linear speed of fluid [ms<sup>-1</sup>].

Transforming the relation (10) into a function depending on the flow rate  $Q$ , one obtains the formula:

$$\Delta p = \lambda \frac{8}{\pi^2} \rho \frac{1}{d^5} Q^2 \quad (7)$$

In the dependence of the linear drag coefficient  $\lambda$  on Re, presented in [9], four zones are distinguished. In the first zone for  $Re < Re_{kr}$  laminar flow occurs (where  $\lambda$  is described by the relations:  $\lambda = \frac{64}{Re}$  or  $\lambda = \frac{75}{Re}$ ). In the second (transition) zone liquid flow is unstable, i.e. either laminar or turbulent flow may happen. Transition from laminar flow to turbulent not fully developed one occurs suddenly. The third zone is characteristic of a not fully developed turbulent flow. In this zone the linear drag coefficient  $\lambda$  for a hydraulically smooth

conduit was described by the following empirical formula according to Blasius:

$$\lambda = \frac{0,3164}{Re^{0,25}} \quad (8)$$

Substituting the relation (8) into the Darcy-Weisbach formula (6) and transforming the so obtained relation into a function of flow rate, one achieves the following :

$$\Delta p = 0,2414 \frac{l \rho}{d^{4,75}} v^{0,25} Q^{1,75} \quad (9)$$

According to the relation (9), in case of a not fully developed flow the pressure losses does not depend, a. o., on the viscosity  $\nu$  and the liquid flow rate  $Q$ . The power exponents which appear in this formula, take, for various flow conditions (e.g. conduit roughness), values different from those given in the formula (9).

The fourth zone is characteristic of a fully developed turbulent flow. In this zone the linear drag coefficient  $\lambda$  depends only on the relative roughness defined by the ratio  $\epsilon/d$  of the absolute roughness  $\epsilon$  and the conduit internal diameter  $d$ . Flows at so large values of Reynolds number rather do not happen in hydrostatic drives. In case of fully developed turbulent flow,  $\lambda$  has a constant value independent on Re.

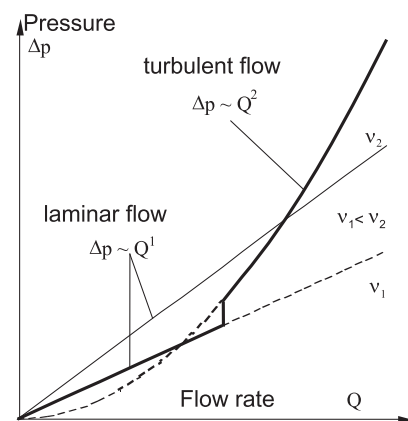

Fig. 1 Relation between the pressure loss  $\Delta p$  and the flow rate  $Q$  [3]

In Fig. 1 the above considered relations which describe pressure losses in function of flow rate are depicted as follows: for laminar flow - by a linear function dependent also on oil viscosity, and for fully developed turbulent flow - by a square function.

In the literature sources [10 ÷ 14] another way of determining the pressure losses  $\Delta P_{Mp}$  in displacement machine internal ducts can be found, as follows :

$$\Delta p_{Mp} = C_t \cdot \rho \cdot Q^2 + C_l \cdot \nu \cdot \rho \cdot Q \quad (10)$$

The formula makes it possible to determine the pressure losses  $\Delta p_{Mp}$  when working liquid parameters such as its density  $\rho$  and viscosity  $\nu$  as well as flow rate  $Q$  are known. Values of the constants  $C_t$  and  $C_l$  can be achieved from the trend line of the characteristics  $\Delta p_{Mp} = f(Q)$  representing the

pressure losses  $\Delta p_{Mp}$  in displacement machine internal ducts in function of its absorbing capacity  $Q$ .

In the literature sources [13, 14] the pressure losses  $\Delta p_{Mp}$  in hydraulic motor are described as follows :

$$\Delta p_{Mp} = C_{ich} \cdot \rho \cdot \omega^2 \cdot \sqrt[3]{\left(\frac{V_t}{2 \cdot \pi}\right)^2} \quad (11)$$

where :

- $C_{ich}$  – coefficient of proportionality;
- $\omega$  – angular speed of displacement machine shaft;
- $V_t$  – theoretical working space.

To increase precision of description of dependence of hydraulic motor energy efficiency on the motor absorbing capacity  $Q_M$  in a wide range of changes in hydraulic oil viscosity  $\nu$ , it is proposed to apply the simulation description of relation of the pressure losses  $\Delta p_{Mp}$  in motor ducts, given by Z. Paszota in [7]. In the case of the considered SWSB-63 motor it turned out that in its ducts a not fully developed turbulent flow occurs.

The model of the pressure losses  $\Delta p_{Mp}$ , proposed by Z. Paszota [7], can be presented as follows:

$$\Delta p_{Mp} = k_8 p_n \left(\frac{Q_M}{Q_{Pt}}\right)^{a_{qp}} \left(\frac{\nu}{\nu_n}\right)^{a_{vp}} \quad (12)$$

Where the coefficient:

$$k_8 = \frac{\Delta p_{Mp}|_{Q_M=Q_{Pt}, \nu_n}}{p_n} \quad (13)$$

determines the pressure losses  $\Delta p_{Mp}$  in hydraulic motor internal ducts and distributor, which would appear at the motor absorbing capacity  $Q_M$  equal to the theoretical capacity  $Q_{Pt}$  of the pump feeding the motor, related to the nominal pressure  $p_n$  of the system in which the hydraulic motor is used.

Application of the dimensionless ratios  $Q_M/Q_{Pt}$  and  $\nu/\nu_n$  in the mathematical model (12) makes it possible to determine the exponent  $a_{qp}$  of influence of the liquid flow rate  $Q_M$  in ducts on the pressure losses  $\Delta p_{Mp}$ , as well as the exponent  $a_{vp}$  of influence of the working liquid viscosity  $\nu$  on the pressure losses  $\Delta p_{Mp}$ , hence it allows to precisely describe the relation  $\Delta p_{Mp}$  in function of  $Q_M$  and  $\nu$ .

The equation (13) defining the coefficient  $k_8$  as well as the mathematical model (12) combine description of the pressure losses  $\Delta p_{Mp}$  in motor ducts with magnitude of the theoretical capacity  $Q_{Pt}$  of the pump and the nominal pressure  $p_n$  of the hydrostatic system [11].

## WAY OF MEASURING THE PRESSURE LOSSES $\Delta p_{Mp}$ IN SWSB-63 MOTOR

Fig. 2 presents a way of measuring the pressure losses  $\Delta p_{Mp}$  in ducts of SWSB-63 motor. Working elements of the motor were disassembled from it to form free flow of working medium. This way the flow conditions close to real ones were reached, i.e. those when distributor's elements rotate with the speed which

corresponds to the motor absorbing capacity  $Q_M$ . The pressure losses  $\Delta p_{Mp}$  in ducts of SWSB-63 motor were calculated as the differential pressure :

$$\Delta p_{Mp} = \Delta p_{de} - \Delta p_{AC} \quad (14)$$

where:

- $\Delta p_{AC}$  – pressure loss measured in the section A – C of liquid flow in the space limited by the drum, which was negligible;
- $\Delta p_{de}$  – pressure loss measured in points d and e (based on fig. 1)[6].

Tab. 1 shows principal working parameters of SWSB-63 motor.

Tab. 1 The principal working parameters of SWSB-63 motor

	$q_{Mt}$ [m <sup>3</sup> ]	$n_{Mn}$ [s <sup>-1</sup> ]	$\nu_n$ [mm <sup>2</sup> s <sup>-1</sup> ]	$p_n$ [MPa]	$M_{Mt}$ [Nm]	$P_{Mc}$ [kW]
SWSB 63 motor	639·10 <sup>-6</sup>	2,67	26	6,2	617,8	10,6

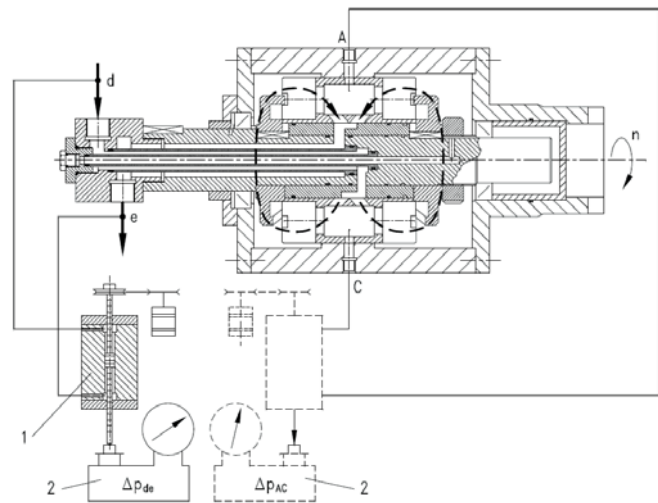

Fig. 2 The SWSB motor adjusted to measuring the pressure losses in internal ducts [6]: 1 – piston pressure gauge serving to measure differential pressure; 2 – tangent balance

## PRESSURE LOSSES IN SWSB-63 HYDRAULIC MOTOR

In order to determine characteristics which make it possible to obtain pressure losses in the tested motor it was necessary to determine in advance parameters of its nominal running. Based on the results of the SWSB-63 motor tests contained in [1], the motor theoretical absorbing capacity  $Q_{Mt}$  equal to

the pump theoretical capacity  $Q_{pt}$  ( $Q_{M1} = Q_{pt} = 1,71 [dm^3 \cdot s^{-1}]$ ) was assumed. The SWSB-63 motor was tested under changeable oil kinematic viscosity  $\nu$  (in the range from  $13 \text{ mm}^2 \cdot \text{s}^{-1}$  to  $150 \text{ mm}^2 \cdot \text{s}^{-1}$ ), hence the reference viscosity  $\nu_n$  was taken equal to  $26 \text{ mm}^2 \cdot \text{s}^{-1}$ . The remaining working parameters are given in Tab. 1.

Fig. 3 shows the characteristics of the pressure losses  $\Delta p_{Mp}$  in ducts of SWSB-63 motor in function of the motor absorbing capacity  $Q_M$  ( $\Delta p_{Mp} = f(Q_M)$ ), at selected constant values of the hydraulic oil kinematic viscosity  $\nu$ .

And, Fig. 4 presents the characteristics of the pressure losses  $\Delta p_{Mp}$  in ducts of SWSB-63 motor in function of the coefficient of oil kinematic viscosity  $\nu/\nu_n$  ( $\Delta p_{Mp} = f(\nu/\nu_n)$ ), at constant values of the motor absorbing capacity  $Q_M$ . The curves were obtained on the basis of the characteristics (Fig. 3) expressing the pressure losses  $\Delta p_{Mp}$  in function of the motor absorbing capacity  $Q_M$  ( $\Delta p_{Mp} = f(Q_M)$ ).

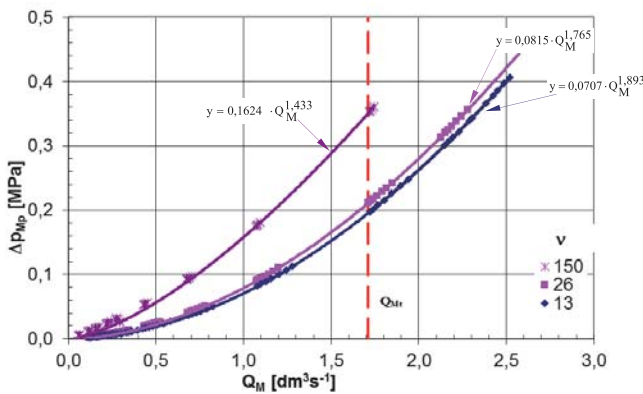

Fig. 3 The pressure losses  $\Delta p_{Mp}$  in motor ducts in function of the SWSB-63 motor absorbing capacity  $Q_M$  at selected constant values of the hydraulic oil viscosity  $\nu$  [4, 5]

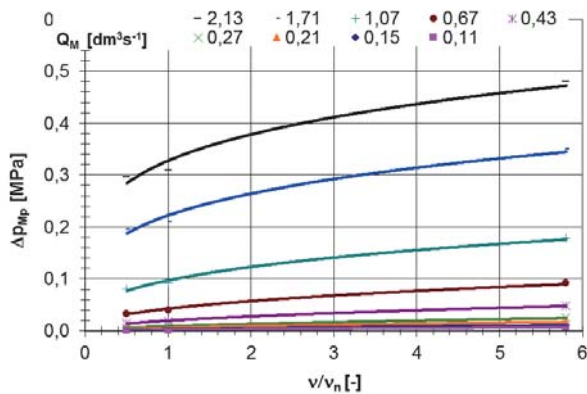

Fig. 4 The pressure losses  $\Delta p_{Mp}$  in motor ducts in function of the oil viscosity coefficient  $\nu/\nu_n$ , at selected values of the motor absorbing capacity  $Q_M$  [4]

## DETERMINATION OF THE COEFFICIENT $k_8$ OF THE PRESSURE LOSSES $\Delta p_{Mp}$ IN SWSB-63 MOTOR AS WELL AS THE EXPONENTS $a_{QP}$ AND $a_{NP}$

The model of pressure losses  $\Delta p_{Mp}$  in hydraulic motor (proposed by Z. Paszota in [7]) takes into account: possible application of it to a model of the motor total efficiency  $\eta_M$  as well as to a model of the efficiency  $\eta$  of hydrostatic drive in which the motor is used, and also possible modification of the model on the basis of laboratory tests of pressure losses in ducts of displacement machine (pump, hydraulic motor) with the aim of increasing accuracy of description of losses in motor of a given construction as well as in the range of changes in oil viscosity occurring in drive system under operation. Knowledge of value of the dimensionless coefficient  $k_8$  for a given motor will make it possible to compare types of motors and their proper assessment during selecting an appropriate motor for a given drive system.

On the basis of the depicted characteristics (Fig. 3 ÷ 6), values of the pressure losses coefficient  $k_8$  (acc. (13)) as well as of the power exponents:  $a_{QP}$  – which determines impact of the liquid flow rate  $Q_M$  in ducts on the pressure losses  $\Delta p_{Mp}$  in hydraulic motor, and  $a_{vp}$  – which determines impact of the working liquid viscosity  $\nu$  on the pressure losses  $\Delta p_{Mp}$  in hydraulic motor.

From Fig. 4 which was depicted for the nominal working parameters of motor (Tab. 1), the value of the pressure loss  $\Delta p_{Mp}$  equal to 0,21 [MPa] was read. By relating the obtained value to the nominal pressure  $p_n$  the following value of the pressure losses coefficient  $k_8$  was achieved in accordance with the formula (13):

$$k_8 = \frac{\Delta p_{Mp}|_{Q_M=Q_{pt}, \nu_n}}{p_n} = \frac{0,21}{6,2} = 0,034, \quad (15)$$

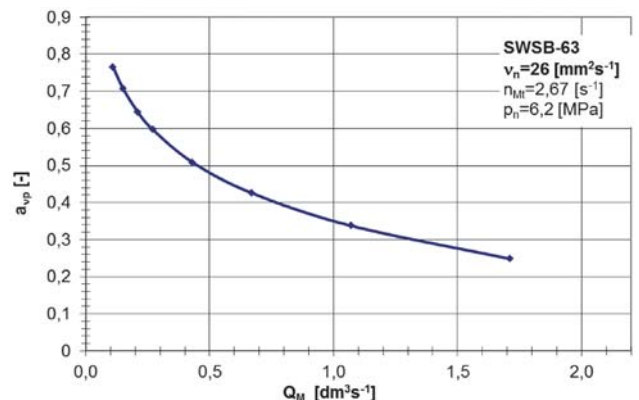

Fig. 5 The exponent  $a_{vp}$  (appearing in the power function  $\Delta p_{Mp} = k_8 p_n (Q_M/Q_{pt})^{a_{QP}} (\nu/\nu_n)^{a_{vp}}$  which describes the relation between the pressure losses  $\Delta p_{Mp}$  in motor ducts and the ratio of  $Q_M$  and pump theoretical capacity  $Q_{pt}$  expressed in function of the motor absorbing capacity  $Q_M$  [4].

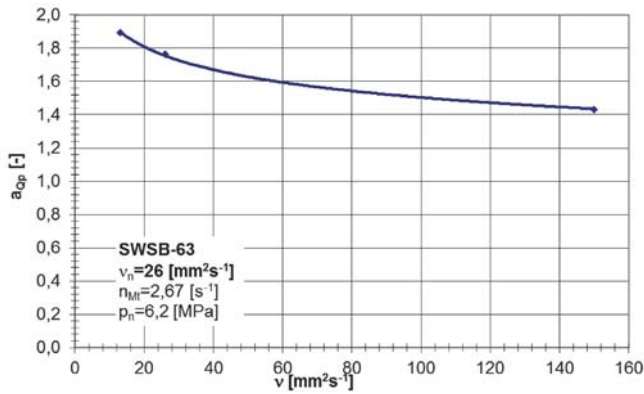

Fig. 6 The exponent  $a_{vp}$  (appearing in the power function  $\Delta p_{Mp} = k_p p_n (Q_M/Q_{Pt})^{a_{Qp}} (v/v_n)^{a_{vp}}$  which describes the relation between the pressure losses  $\Delta p_{Mp}$  in motor ducts and the ratio of  $Q_M$  and pump theoretical capacity  $Q_{Pt}$ ) expressed in function of the working liquid viscosity  $v$ , [4]

As a result, the simulation formula for determining the pressure losses  $\Delta p_{Mp}$  in ducts of SWSB-63 motor at changeable viscosity  $v$ , takes the following form :

$$\Delta p_{Mp} = 0,034 p_n \left( \frac{Q_M}{Q_{Pt}} \right)^{1,77} \left( \frac{v}{v_n} \right)^{0,25} \quad (16)$$

Simulation calculations of the pressure losses were performed by using the formula (9). Their results are presented in Fig. 7.

Comparing the characteristics of pressure drops in the motor with results of the simulation calculations, one can observe that differences in values of pressure drops amount to 1% on average.

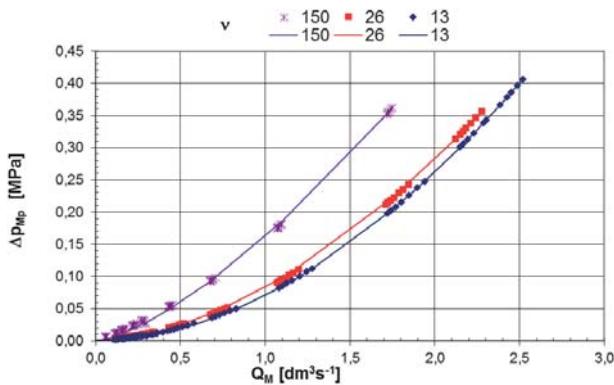

Fig. 7 Comparison of the working medium pressure losses  $\Delta p_{Mp}$  in ducts of SWSB-63 motor, described by the mathematical model (9) (continuous lines) with the results of measurements (points on the curves) [1]

## CONCLUSIONS

1. The investigations on pressure losses in SWSB-63 hydraulic motor at three values of oil viscosity, conducted within frames of the work [1], revealed that the losses follow the relation:  $\Delta p_{Mp} \sim Q^{1,77}$ . The

results confirmed that in the ducts of the tested machine a not fully developed turbulent flow occurs. The similar confirmation can be found from the tests of pressure losses in PTO2-16 hydraulic axial piston motor of constant absorbing capacity per rotation at the recommended viscosity  $v_n = 35 \text{ mm}^2 \text{ s}^{-1}$  of L-HL46 hydraulic oil (9 equal to abt.  $46^\circ \text{C}$ ), carried out by M. Czyński within the frames of the work [2] - the tests showed that the losses in question follow the relation:

2. From the characteristics (Fig. 3) presenting the pressure losses  $\Delta p_{Mp}$  in ducts in function of the SWSB-63 motor absorbing capacity  $Q_M$  it can be observed that the value of the exponent  $a_{Qp}$  decreases along with viscosity increasing. This confirms that the formulae (7) and (9) interpreted in Fig. 1, are correct, i.e. that in the case of the relation  $\Delta p_{Mp} \sim Q^1$  we deal with laminar flow, and in the case of  $\Delta p_{Mp} \sim Q^2$  - with fully developed turbulent flow.
3. The impact of the working liquid viscosity  $v$  on the pressure losses  $\Delta p_{Mp}$  in internal ducts (Fig. 4), at  $v_n = 26 \text{ [mm}^2 \text{ s}^{-1}]$  and the motor theoretical absorbing capacity  $Q_{Mt} = 1,71 \text{ [dm}^3 \text{ s}^{-1}]$ , is determined by

the value of the power exponent  $a_{vp}$  appearing in the function  $\Delta p_{Mp} \sim \left( \frac{v}{v_n} \right)^{a_{vp}}$ , where  $a_{vp} \approx 0,249$ .

And, value of the exponent increases at decreasing absorbing capacity, hence at  $Q_M = 0,11 \text{ [dm}^3 \text{ s}^{-1}]$  it amounts to  $a_{vp} \approx 0,764$ . The values of the exponent  $a_{vp}$  allow to conclude that the pressure losses  $\Delta p_{Mp}$  in internal ducts have character of a disturbed flow with a decreasing degree of the disturbance which accompanies the lowering of absorbing capacity.

## BIBLIOGRAPHY

1. Balawender A., Osiecki A., Paszota Z., Klimkiewicz W., Ciepielowski J.: Tests of SWSB-63 large-torque medium-pressure hydraulic motor ( in Polish). Scientific research work, Gdańsk 1972
2. Czyński M.: Laboratory tests of a model of energy efficiency of hydrostatic transmission ( in Polish). Doctor's degree thesis. Szczecin University of Technology. Faculty of Ship Engineering. Szczecin 2005
3. Koralewski J.: Impact of viscosity on energy losses in changeable capacity piston pump ( in Polish). Essential report on the promoting research project No. N N504 4684 33, ?
4. Maczyszyn A., Energy analysis of construction of displacement rotary machines applicable to hydrostatic transmissions ( in Polish ). Doctor's degree thesis, Gdańsk

University of Technology, Faculty of Ocean Engineering and Ship Technology, Gdańsk 2014

5. Maczyszyn A.: Evaluation of losses in a hydraulic motor based on the SWSB - 63 motor tests. Polish Maritime Research, Vol. 17, No 4, 2010, pp. 46-53,
6. Paszota Z. : Aspects energetiques des transmissions hydrostatiques ( in French) . Publ. Gdańsk University of Technology, Gdańsk 2002
7. Paszota Z., Energy losses in hydrostatic drive. Drive investigation method compatible with diagram of power increase opposite to the direction of power flow . Lambert Academic Publishing, Saarbrucken 2016
8. Skorek G.: Laboratory tests of pressure losses in displacement pump ( in Polish), *Hydraulika i Pneumatyka* 2, 2005.
9. Stryczek S.: Hydrostatic drive, Vol. 2 : Systems ( in Polish), Scientific Technical Publishers (WNT) , Warsaw 1997
10. Sliwinski P.: New satellite pumps. *Key Engineering Materials*, No. 490/2012
11. Sliwinski P.: The basics of design and experimental tests of the commutation unit of a hydraulic satellite motor. *Archives of Civil and Mechanical Engineering*, No. 16/2016, DOI:[1016/j.acme.2016.04.003](https://doi.org/10.1016/j.acme.2016.04.003).
12. Sliwinski P.: The flow of liquid in flat gaps of satellite motors working mechanism. *Polish Maritime Research*, 2, 2014.
13. Sliwinski P.: The influence of water and mineral oil on volumetric losses in a hydraulic motor. *Polish Maritime Research*, Special issue S1 (93), Vol. 24, 2017, DOI: 10.1515/pomr-2017-0041.
14. Sliwinski P.: The influence of water and mineral oil on mechanical losses in hydraulic motor. *Chinese Journal of Mechanical Engineering*. (*article in print*).

## CONTACT WITH THE AUTHOR

Agnieszka Maczyszyn

*e-mail: [agnieszka.maczyszyn@pg.edu.pl](mailto:agnieszka.maczyszyn@pg.edu.pl)*

Gdańsk University of Technology  
11/12 Narutowicza St.  
80 - 233 Gdańsk  
**POLAND**