

NUMERICAL STRENGTH STUDY OF ULTRA-LIGHT COMPOSITE SEAT FRAME DESTINED TO PASSENGERS TRANSPORT

LESZEK CZECHOWSKI¹, MARIA KOTELKO², MARCIN JANKOWSKI³

Abstract

The paper concerns numerical study of the ultra-light seat frame serving transported patients in ambulance. The structure of seat was designed to be built of the carbon fibers, aluminium and steel. The present prototype distinguishes itself with low mass and high strength. During modelling, the stress state and displacement state were verified based on requirements according to regulation ECE14. In simulation, solid, beam and connection elements were employed to consider all the parts of structures. The analysis of the stress state verification based on the assumptions of boundary conditions close to regulation ECE14. The isotropic materials were considered to be in elastic range. In case of composite materials, TSAI-WU (TSW) criterion for assessment of strength was taken into account. Five different variants of seat were taken into consideration to indicate the differences between them. The paper includes the results of analysis of composite structure under static loads which were shown and discussed.

Keywords: numerical simulations, composite material, failure criteria, strength analysis

1. Introduction

The analysis of ultra-light material with high strength in engineering structures is always a challenge because final price of product should be taken into account simultaneously by satisfying the adequate safety regulations during conveyance [6]. One of the most effective solutions is an application of composite material because of very high load-capacity in reference to weight ratio of structural elements made of such materials [1]. Different kinds of composite materials in study can be found in the literature. Authors in paper [5] analysed concrete filled steel tubular column experimentally and numerically. Kim and Yoon in [7] designed, analysed and manufactured glass fibers reinforced prepreg (GFRP) composite bogie frame to be used in urban subway trains. This produced bogie was tested under critical load conditions and the results of experiment were compared

¹ Lodz University of Technology, Department of Strength of Materials Stefanowskiego Street 1/15, 90-537 Łódź, Poland, e-mail: leszek.czechowski@p.lodz.pl, ORCID: 0000-0002-4718-6215

² Lodz University of Technology, Department of Strength of Materials Stefanowskiego Street 1/15, 90-537 Łódź, Poland, e-mail: maria.kotelko@p.lodz.pl, ORCID: 0000-0001-7784-4349

³ OKB Sp. z o.o., Szkolna Street 9, 95-006 Bukowiec, Poland e-mail: m.jankowski@okb.eu, ORCID: 0000-0002-1010-7798

with numerical results. Rong et al. in [11] studied experimentally and numerically hysteretic behaviour composite frame under seismic load. Yong et al. in paper [15] investigated the stress state in frame-truss composite wall by using Abaqus software to simulate the places of the cracks in structures. In the literature, one can distinguish papers devoted to an analysis of composite plate [3], plate structures [4, 13], beams [9, 16, 17] and cylindrical structure [8]. Authors of these papers studied the stress state in single structures taking into account both experimental tests and numerical approach based on finite element method (FEM). Furthermore, in many numerical methods at analysing the structures strength, failure criteria for composite materials are considered to predict the fields of damage. Authors of paper [2] dealt with the optimisation of a dummy-seat subjected to impact load. To solve problem, they employed the Hyper Mesh and LS-dyna software based on FEM and explicit method. Siefert et al. in [12] analysed the impact of vibrations on the human body coming from real excitations during vehicle motion by applying Abaqus software.

Present work relates also to the approach based on FEM within failure criteria application but present frame of analysed seat is decidedly more complicated with regard to a connection of composite parts with metal elements. Moreover, the number of considered elements in present analysis is substantially greater and numerical model seems to be fully complex. The paper is relied upon the results of numerical simulations because exact tests are still conducted.

2. Description

The present paper includes the modelling and studies of seat structure (Figure 1a) assigned to a transport of the passengers in special vehicles, e.g. ambulance (Figure 1a). The frame of seat can easily be folded up to be transported in vehicle (Figure 1b). The analysed structure of the seat is composed both of aluminium and steel elements and of multilayer composite parts. The latter ones are considered to carry the essential loads. The full model with general dimensions is displayed in Figure 2. The structure has been developed to achieve the minimum of weight, simultaneously fulfilling the strength demands contained in Regulation ECT 14 [10]. The problem was solved on the basis of FEM by using **MIDAS NFX** software [14]. The considered composite material was carbon fiber epoxy resin prepeg. The properties of analysed materials are shown in Table 1. The numerical model of a chair with boundary condition is presented in Figure 3. The more information and more details about the structure of seat have been encrypted and not given in this paper.



(a)



(b)

Fig. 1. The fabricated seat frame; (a) folded out, (b) folded up

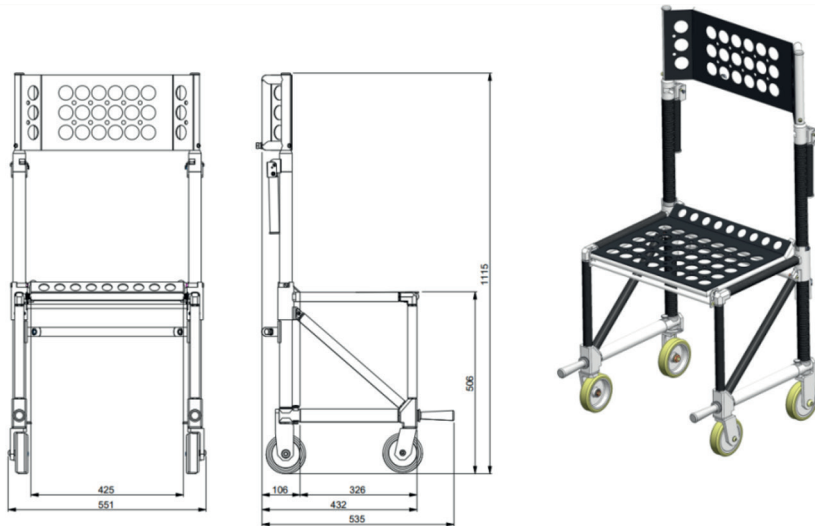

Fig. 2. Three-dimensional model with general dimensions

Tab. 1. Material properties of analysed frame parts.

Material	Aluminium	Steel	Composite
Young Modulus in 1-direction (0°) [GPa]	72	210	175
Young Modulus in 2-direction (90°)[GPa]	72	210	8
Poisson's ratio [-]	0.33	0.30	0.30
Shear Modulus [GPa]	27.1	80.8	5.0
Tensile strength in 1, 2-direction (0°, 90°) [MPa]	280, 280	400, 400	1000, 40
Compressive strength in 1, 2-direction (0°, 90°) [MPa]	280	400	800, 200

3. FE model

The analysis of seat strength was conducted on the basis of finite element method by using **MIDAS NFX** software [14]. The simulations in linear range (Hook's law) were done by using beams, shell and solid elements. For some regular parts of seat, solid elements were generated by sweeping option to achieve correct mesh. The number of modelled parts included approximately 100 parts to which adequate material properties were attributed. The element size of finite element ranged from 1 mm to 4 mm. Then, the total number amounted to about one million. The number of degrees of freedom was equal above 4 millions. For the purpose of connecting the touching parts, contact elements were applied. The discrete model of frame with boundary conditions is presented in Figure 3. After preliminary numerical analysis, arrangement of layers at 0°/90°/0°/90°/0° in composite parts was taken into account. The main direction of orthotropy corresponds to longitudinal axis of given profile. The thicknesses of composite profiles were usually assumed to be 2 mm but for some parts of the frame the thicknesses with regard to considered variants were included between 1.5mm to 5 mm (upper and lower vertical profiles, e.g.). The number of layers was constant for all profiles and equal to 5. In general, 5 variants were assumed to be verified (Table 2). Each layer possessed the same thickness. It means that detailed layer amounted to 1/5 of total wall thickness of given profile. Analysed variants differed from each other by an assumption of different wall thicknesses of circular profiles shown in Figure 3 (upper and lower vertical profiles).

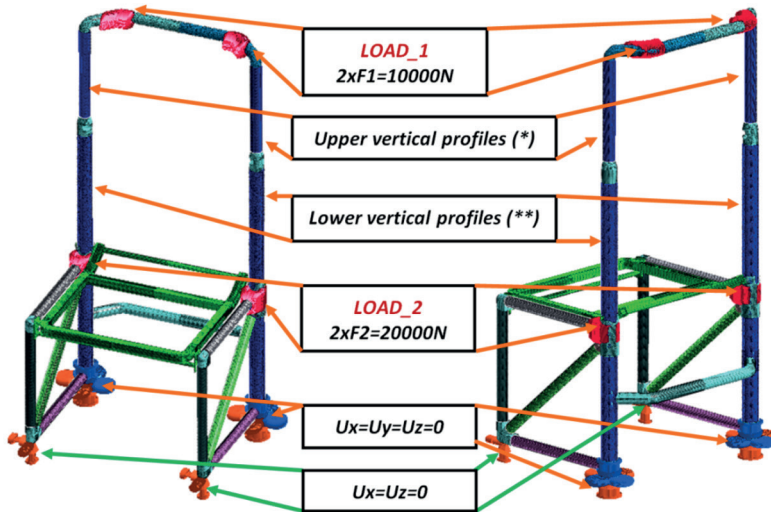

Fig. 3. Discrete model with assumed boundary conditions

Tab. 2. Description of considered variants

Description of variant	All profiles mm	Upper vertical profiles mm (*)	Lower vertical profiles mm (**)
Var_1	2.0	1.5	1.5
Var_2	2.0	1.5	5.0
Var_3	2.0	3.0	2.0
Var_4	1.0	1.0	1.5
Var_5	1.0	2.0	3.0

4. Results and discussion

4.1. Displacements

This subsection presents the numerical results. The maps of total displacements for 10%, 50% and 100% of full load are presented in Table 3. The maximum values of total displacements at full load included between 127 mm and 267 mm for Var_2 and for Var_1. The chart of maximum total displacement versus relative load (Load/Loadmax*100%) is displayed in Figure 4. It can be easily seen that Var_2 distinguish with highest stiffness but simultaneously its weight is the greatest because the thickness of lower profiles

amounted to 5 mm. Based on obtained results, the optimal model seems to be Var_5, because the moderate weight is retained and its stiffness is close to Var_1. By changing the thicknesses of remaining parts from 2 mm to 1mm, slight influence was noticed. It is also seen that Var_3 and Var_5 are comparable in stiffness value.

Tab. 3. The total displacement for all variants; (a) 10% load, (b) 50% load and 100% load

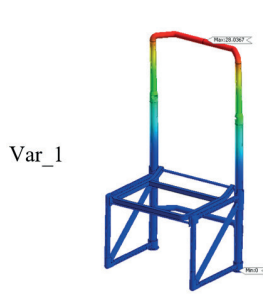
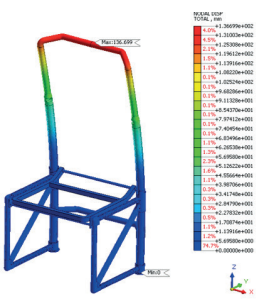
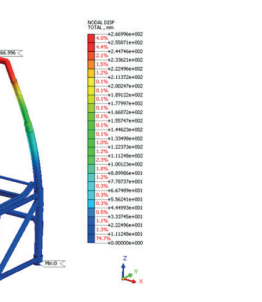
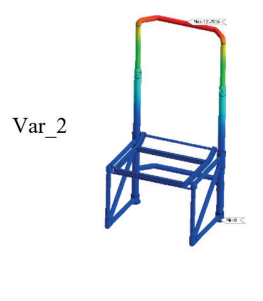
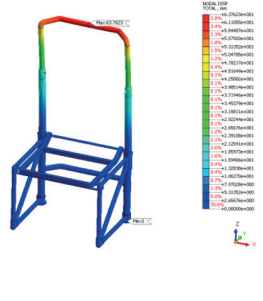
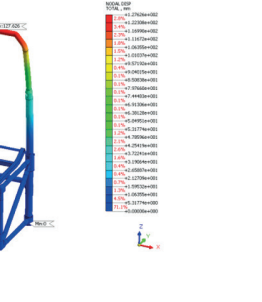
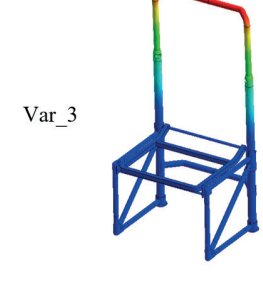
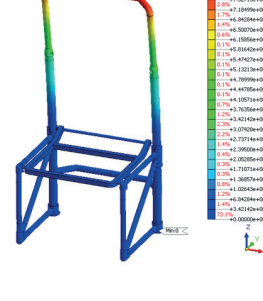
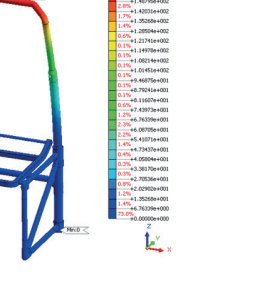
No. of var.	10%	50%	100%
Var_1			
Var_2			
Var_3			

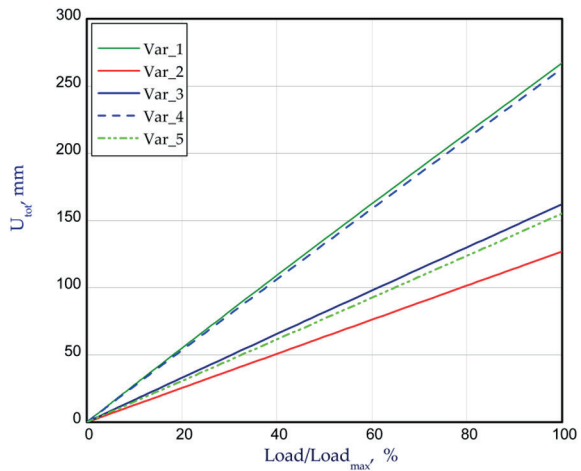
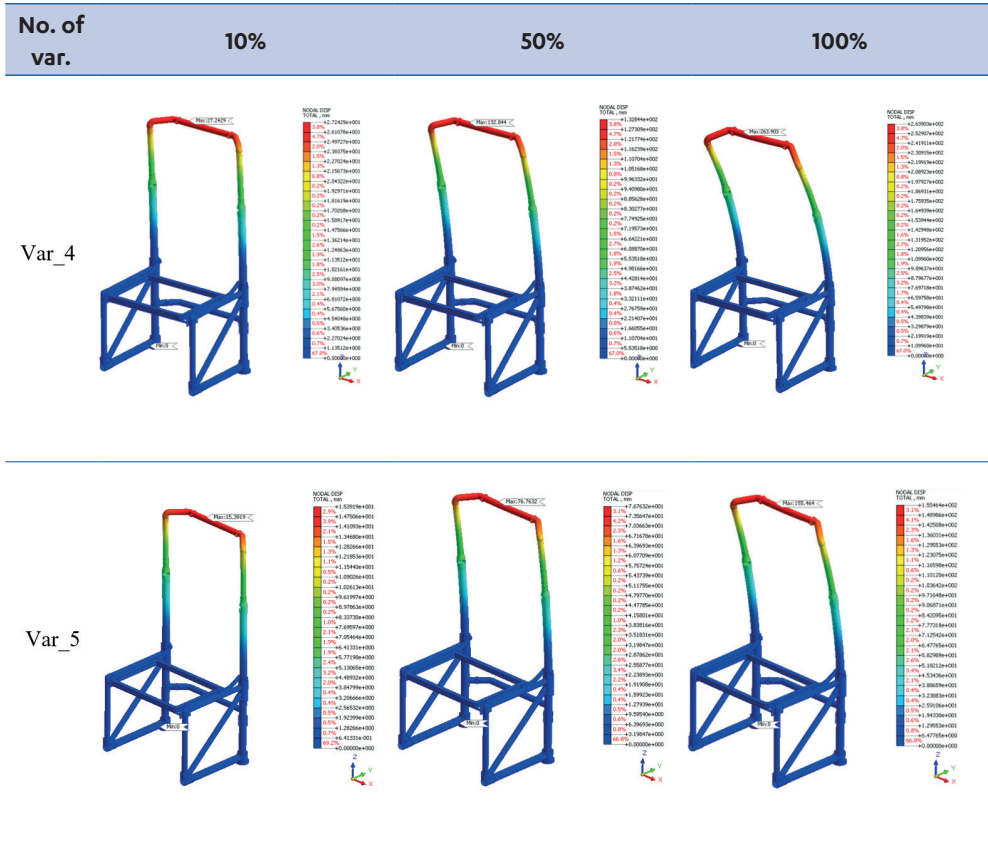
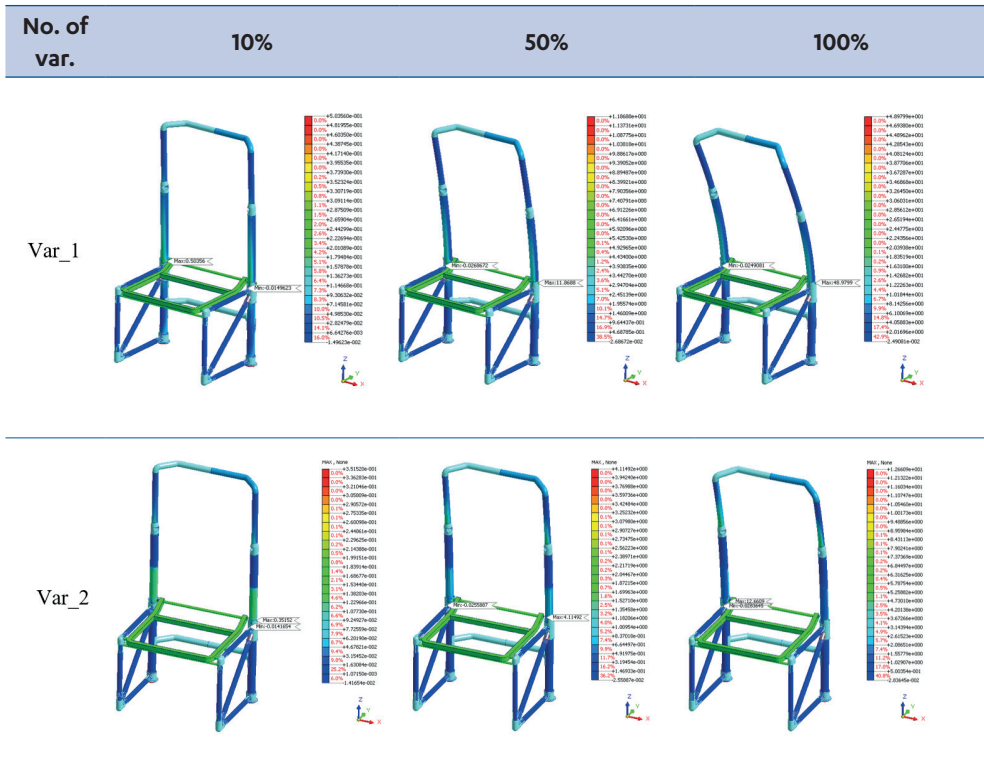

Fig. 4. Total displacement for analysed variants vs. load ratio

4.2. Strength ratio

This subsection presents maps of strength ratio (SR) based on Tsai-Wu (TSW) criterion for composite parts. The analysis of metallic elements strength wasn't taken into account. The places where SR is greater than unity denote the possibility of crack propagation initiation. Of course, high value of SR in conducted simulation can be done due to a concentration of stresses. The maps of SR for 10%, 50% and 100% of full load are sorted out in Table 4. In case of total displacements, obtained values are linear but in case of SR even at linear solution of problem, SR maps don't change linearly vs. load. It results from the fact that equation of stress state for composite materials is dependent upon many parameters influencing whole SR. Based on the calculations results (Figure 5), the maximum values of SR were noticed for Var_5 however Var_1 with regard to the smallest thicknesses seemed to be the weakest. It should be noted that for all variants at full load SR was always exceeded. As previously, Var_3 and Var_5 are comparable and the most optimal. It should be mentioned that maximum SR shown on maps increased by a few times from 50% to 100% of full load (for Var_2 from 2.25 to 8.2 and for Var_5 from 1.07 to 8.74, e.g.). According to simulation results, it means that frame for Var_5 might carry about 50% of full load.

Tab. 4. The SR defined by TSW criterion for all variants for 10%, 50% and 100% of maximum load



No. of var.	10%	50%	100%
-------------	-----	-----	------

Var_3

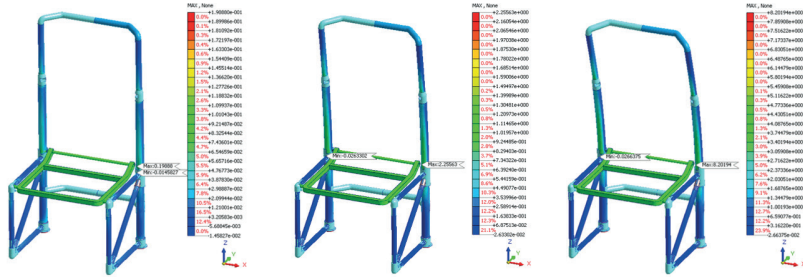

Var_4

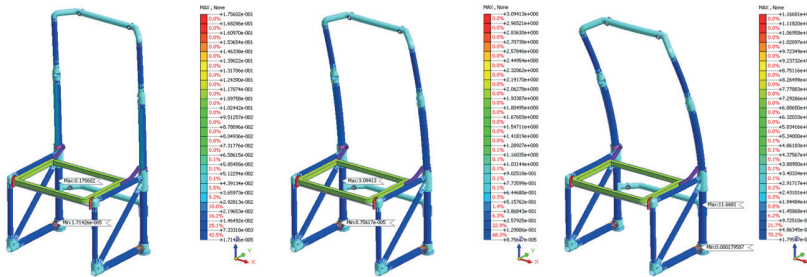

Var_5

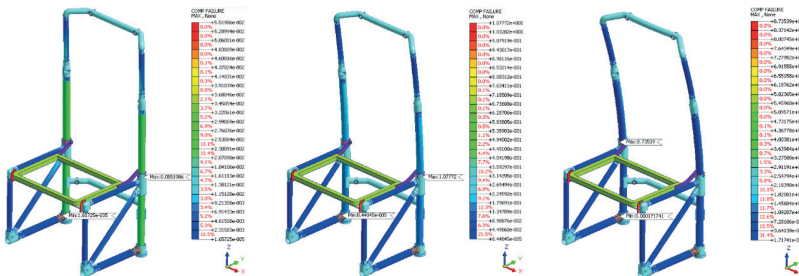

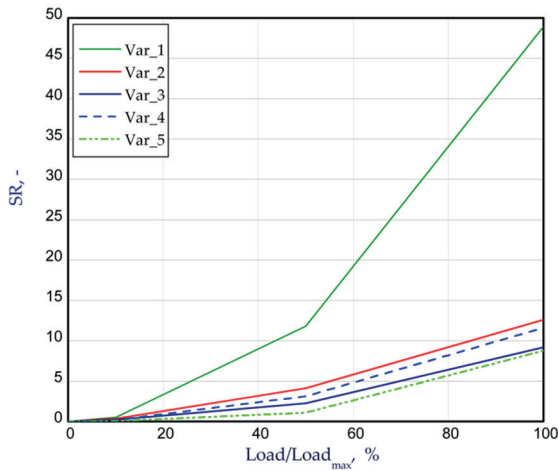

Fig. 5. Total displacement for analysed variants vs. load ratio

5. Conclusions

The work concerned the analysis of ultra-light structure of seat subjected to loads corresponded to requirements of regulation ECE14. To evaluate the stress state occurring in the chair frame, several analyses for different variants of design solutions were performed. The results of present paper show modelling complex frame composed from metal parts and composite profiles. On the basis of the calculations it was stated that Var_5 can be the most optimal model with respect to both its weight and its strength. It should be mentioned that the present paper refers to modelling and the strength analysis based on numerical approach without a verification with experimental results which are still being conducted. Based on attained SR maps at maximum required load for all variants, the maximum SR exceeded the value 1 several times in some regions of composite frame but these results of simulations can be acceptable because empirical test permits of local damages of the frame providing that some conditions included in regulation EC14 are fulfilled.

6. Acknowledgement

The work was executed thanks to support of the Operational Programme for the Lodzkie Voivodeship. Application no: **RPLD.01.02.02-10-0056/16-01** (“**IKK – Innovative Cardiac Chair**”).

7. Nomenclature

FEM	finite element method
EN	European Norm International
SR	strength ratio
TSW	Tsai-Wu
Utot	total displacements

8. References

- [1] Berthelot J.M.: Composite Materials-Mechanical Behaviour and Structural Analysis. Springer Verlag, New York Inc., 1999.
- [2] Chen H., Chen H., Wang L.: Analysis of Vehicle Seat and Research on Structure Optimization in Front and Rear Impact. *World Journal of Engineering and Technology*. 2014, 2(2), 92–99, DOI: 10.4236/wjet.2014.22010.
- [3] Devarajan B., Kapania R.K.: Thermal buckling of curvilinearly stiffened laminated composite plates with cutouts using isogeometric analysis. *Composite Structures*. 2020, 238, 111881, DOI: 10.1016/j.compstruct.2020.111881.
- [4] Dębski H., Kubiak T., Teter A.: Buckling and postbuckling behaviour of thin-walled composite channel section column. *Composite Structures*. 2013 100, 195–204, DOI: 10.1016/j.compstruct.2012.12.033.
- [5] Gao S., Guo L., Zhang Z.: Anti-collapse performance of composite frame with special-shaped MCFST columns. *Engineering Structures*. 2021, 245, 112917, DOI: 10.1016/j.engstruct.2021.112917.
- [6] Grujicic M., Cheeseman B.A.: Concurrent Computational and Dimensional Analyses of Design of Vehicle Floor-Plates for Landmine-Blast Survivability. *Journal of Materials Engineering and Performance*. 2013, 23(1), 1–12, DOI: 10.1007/s11665-013-0637-5.
- [7] Kim J.S., Yoon H.J.: Structural Behaviors of a GFRP Composite Bogie Frame for Urban Subway Trains under Critical Load Conditions. *Procedia Engineering*. 2011, 10, 2375–2380, DOI: 10.1016/j.proeng.2011.04.391.
- [8] Kopecki T., Mazurek P., Lis T.: Experimental and Numerical Analysis of a Composite Thin-Walled Cylindrical Structures with Different Variants of Stiffeners, Subjected to Torsion. *Materials*. 2019, 12(19), 3230, DOI: 10.3390/ma12193230.
- [9] Kubiak T., Borkowski Ł., Wiacek N.: Experimental Investigations of Impact Damage Influence on Behavior of Thin-Walled Composite Beam Subjected to Pure Bending. *Materials*. 2019, 12(7), 1127, DOI: 10.3390/ma12071127.
- [10] Regulation ECE 14: Uniform provisions concerning the approval of vehicles with regard to safety belt anchorages. Technical report, United Nations Economic Commission for Europe: EUR-Lex - 42011X0428(01) - EN - EUR-Lex (europa.eu) (28 April 2011).
- [11] Rong B., Sun J., Xu M., Zhang R., Sun Y., Zhang W., Zhang W.: Experimental and numerical research on seismic performance of S-RC-SRC composite frame. *Journal of Building Engineering*. 2021, 43, 103119, DOI: 10.1016/j.jobe.2021.103119.
- [12] Siefert A., Hofmann J., Veeraraghavan A., Lu Y.: Numerical Methods for Combined Analysis of Seat and Ride-Comfort. *SAE Technical Paper*. 2019, DOI: 10.4271/2019-01-0404.
- [13] Urbaniak M., Teter A., Kubiak T.: Influence of boundary conditions on the critical and failure load in the GFRP channel cross-section columns subjected to compression. *Composite Structures*. 2015, 134, 199 0150–208, DOI: 10.1016/J.COMPSTRUCT.2015.08.076.
- [14] User's Guide MIDAS® FEA NX: midasoft.com.
- [15] Yong X., Wang Z.M., Li X.L., Fan B.: Internal force analysis of the resistance unit of frame-truss composite wall. *Journal of Building Engineering*. 2021, 44, 103307, DOI: 10.1016/j.jobe.2021.103307.
- [16] Zaczynska M., Kolakowski Z.: The influence of the internal forces of the buckling modes on the load-carrying capacity of composite medium-length beams under bending. *Materials*. 2020, 13(2), 455, DOI: 10.3390/ma13020455.
- [17] Zhu X., Xiong C., Yin J., Yin D., Deng H.: Bending Experiment and Mechanical Properties Analysis of Composite Sandwich Laminated Box Beams. *Materials*. 2019, 12(18), 2959, DOI: 10.3390/ma12182959.